

MCB 1005 B Series

Specification

A decorative background consisting of overlapping, semi-transparent blue geometric shapes, including cubes and prisms, creating a 3D effect.

Product Name	Chip Ferrite Bead
Series	MCB B Series
Size	EIAJ 1005

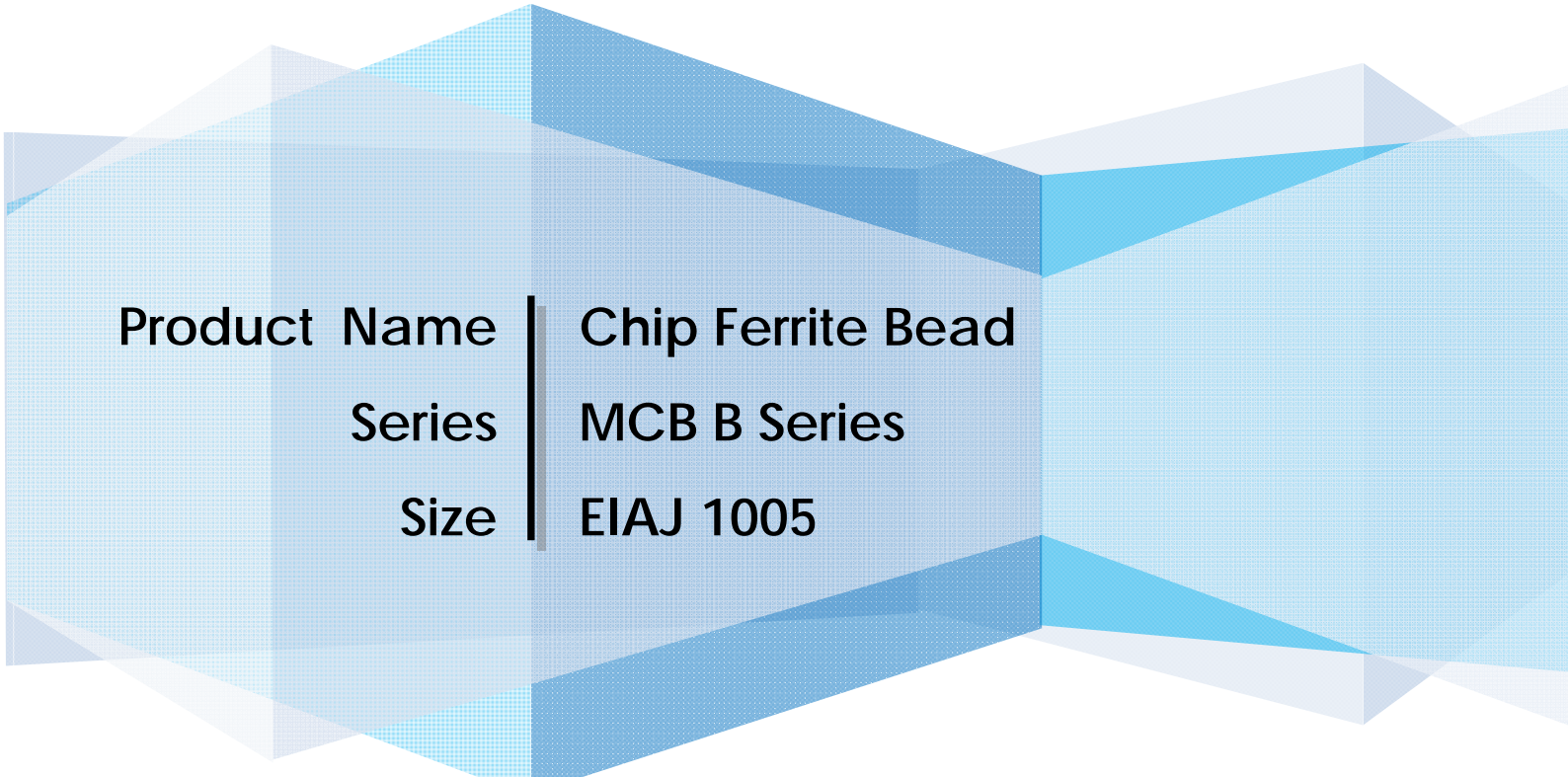

Chip Ferrite Bead (MCB B Series) Engineering Spec.

■ PRODUCT DETAIL

Electrical Characteristics			Test Instruments
Z	Ω (Ref. Page 6)	TEST FREQ: (Ref. Page 6)MHz	●HP4291B RF IMPEDANCE / MATERIAL ANALYZER ●HP4338A/B MILLIOHMMETER ●Agilent 8720ES S-PARAMETER NETWORK ANALYZER ●HP6632B SYSTEM DC POWER SUPPLY
DCR	Ω (Ref. Page 6)		
IDC	mA (Ref. Page 6)	TEST LEVEL: 250 mV	

■ SHAPES AND DIMENSIONS

Unit: mm

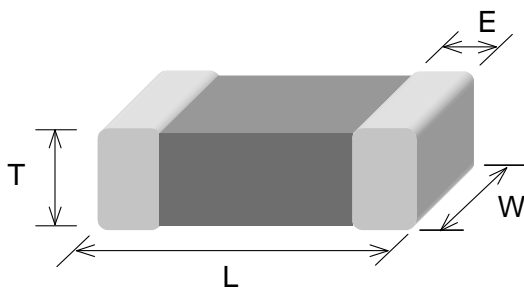

TYPE	1005 (EIA 0402)
L	1.00 ± 0.10
W	0.50 ± 0.10
T	0.50 ± 0.10
E	0.25 ± 0.10

■ PART NUMBER CODE

MCB 1005 B 60 1 E B P
 1 2 3 4 5 6 7 8

- 1 Series Name
- 2 Size Code: the first two digitals : length(mm), the last two digitals : width(mm)
- 3 Material Code
- 4 Impedance(Ω) $\pm 25\%$ } (ex : 600=60 Ω ; 121=120 Ω)
- 5 Fixed Decimal Point }
- 6 Rated Current Code

A=50mA	B=80mA	C=100mA	D=150mA	E=200mA	F=300mA
G=400mA	H=500mA	I=600mA	J=700mA	K=800mA	

- 7 Soldering : Green Parts: A— Soldering Lead-Free B— Lead-Free for whole chip
- 8 Packaging: P - Embossed paper tape, 7" reel.

■ PART NUMBER AND CHARACTERISTICS TABLE

MCB1005-B Series

Part No.	Impedance(Ω) +/-25%	Test Freq. (MHz)	DCR(Ω) (Max.)	Rated Current (mA)
MCB1005B601FB_	600	100	0.60	300
MCB1005B102EB_	1000	100	1.00	200
MCB1005B152DB_	1500	100	1.50	150

** For special part number which is not shown in the above table, please refer to appendix.

■ TAPE AND REEL SPECIFICATIONS PLASTIC CARRIER

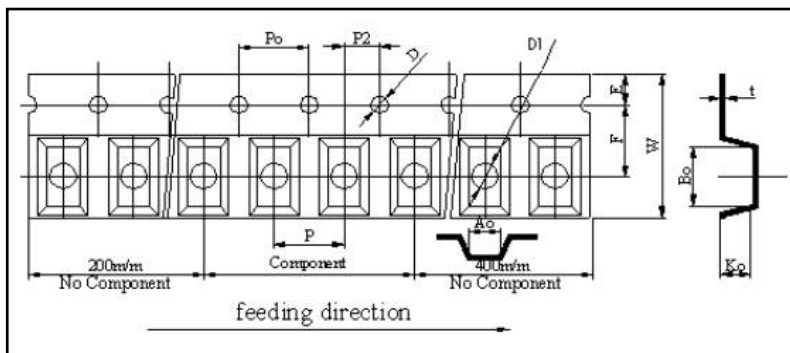

PAPER CARRIER

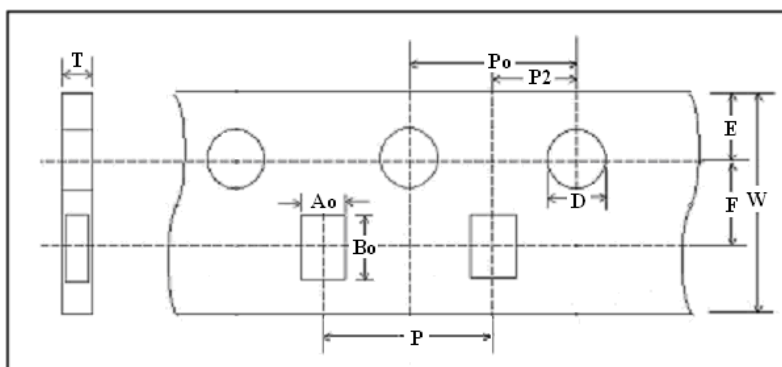

■ TAPING DIMENSIONS

Unit: mm

Size	1005
Symbol	PAPER
W	8.00±0.10
P	2.00±0.05
E	1.75±0.05
F	3.50±0.05
D	1.55±0.05
D1	NA
Po	4.00±0.10
Po10	NA
P2	2.00±0.05
Ao	0.62±0.03
Bo	1.12±0.03
Ko(T)	0.60±0.03
t	NA

■ REEL DIMENSIONS

Unit: mm

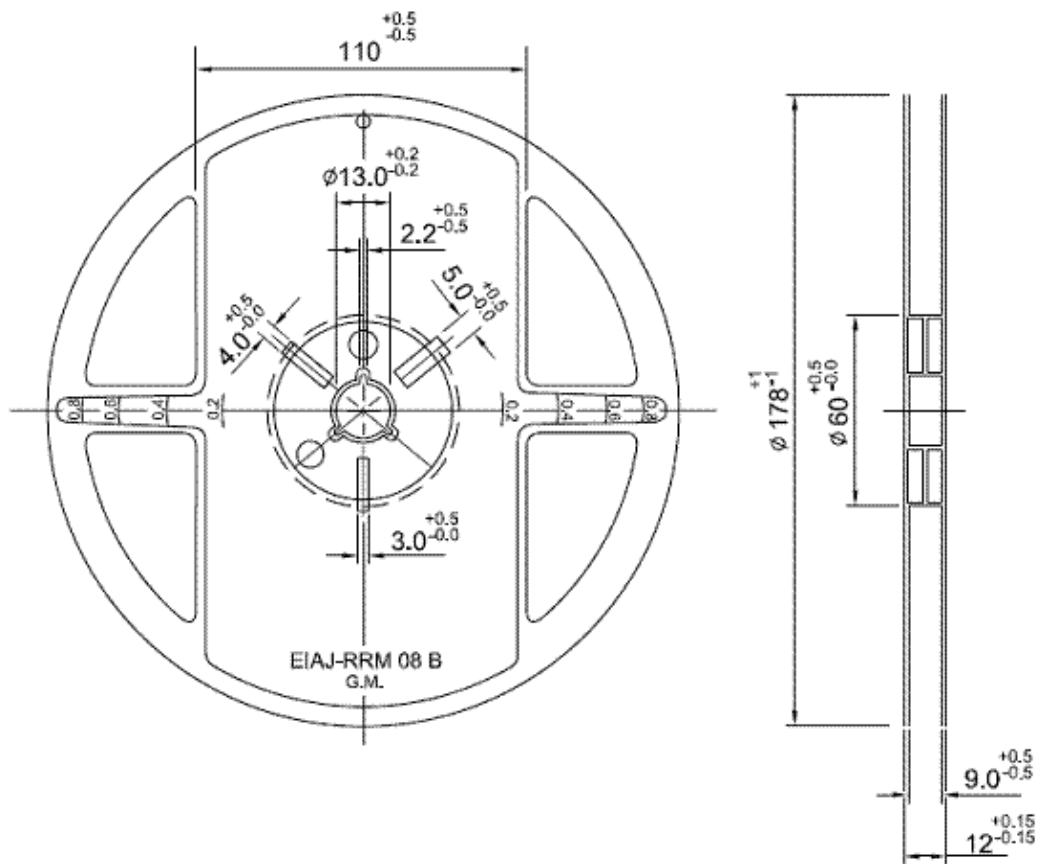

Reel Packaging Quantity		
PART SIZE (EIA SIZE)		1005 (0402)
7" REEL	Qty. (pcs)	10,000

The Contents of a box :

1005 (0402): 5 reels / inner box

RECOMMENDED SOLDERING CONDITIONS

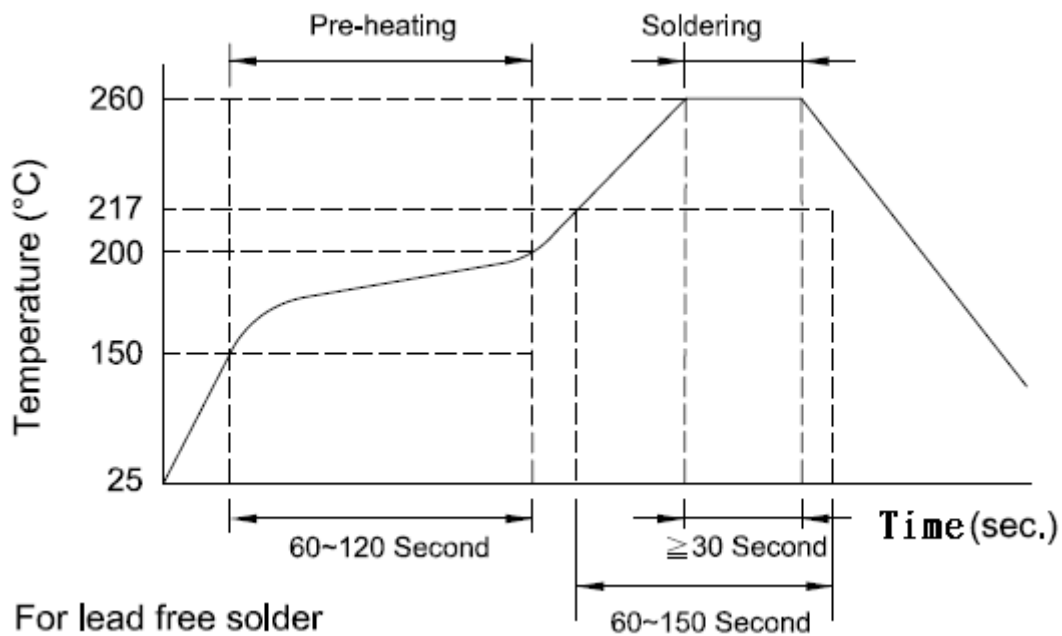

■ LAND PATTERNS FOR REFLOW SOLDERING

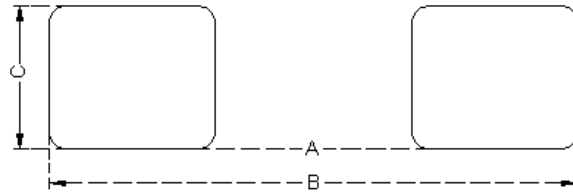

■ SOLDER LAND INFORMATION

Unit: mm (inches)

Size	A	B	C
1005	0.4 ~ 0.6 (0.015 ~ 0.023)	1.6 ~ 2.6 (0.063 ~ 0.102)	0.4 ~ 0.7 (0.016 ~ 0.027)

■ RELIABILITY AND TEST CONDITION

Test item	Test condition	Criteria
Temperature Cycle	a. Temperature : -40 ~ +85°C b. Cycle : 100 cycles c. Dwell time : 30minutes d. Measurement : at ambient temperature 24 hrs after test completion	a. No mechanical damage b. Impedance value should be within $\pm 20\%$ of the initial value
Operational Life	a. Temperature : 125°C $\pm 5^\circ\text{C}$ b. Test time : 1000 hrs c. Apply current : full rated current d. Measurement : at ambient temperature 24 hrs after test completion	a. No mechanical damage b. Impedance value should be within $\pm 20\%$ of the initial value
Biased Humidity	a. Temperature : 40°C $\pm 2^\circ\text{C}$ b. Humidity : 90 ~ 95 % RH c. Test time : 1000 hrs d. Apply current : full rated current e. Measurement : at ambient temperature 24 hrs after test completion	a. No mechanical damage b. Impedance value should be within $\pm 20\%$ of the initial value
Resistance to Solder Heat	a. Solder temperature : 260 $\pm 5^\circ\text{C}$ b. Flux : Rosin c. DIP time : 10 ± 1 sec	a. More than 95 % of terminal electrode should be covered with new solder b. No mechanical damage c. Impedance value should be within $\pm 20\%$ of the initial value
Adhesive Test	a. Reflow temperature : 245°C It shall be Soldered on the substrate applying direction parallel to the substrate b. Apply force(F) : 5 N c. Test time : 10 sec	a. No mechanical damage b. Soldering the products on PCB after the pulling test force > 5 N
Steam Aging Test	a. Temperature : 93°C b. Test time : 4 hrs c. Solder temperature : 235 $\pm 5^\circ\text{C}$ d. Flux : Rosin e. DIP time : 5 ± 1 sec	More than 95 % of terminal electrode should be covered with new solder
Rated Current Test	a. Apply current : full rated current / 5min	Temperature rise should be less than 25°C

■ **GENERAL TECHNICAL DATA**

Operating temperature range : - 55°C ~ +125°C

Storage Condition : Less than 40°C and 70% RH

Storage Time: 6 months Max.

Soldering method: Reflow or Wave Soldering

X-ON Electronics

Largest Supplier of Electrical and Electronic Components

Click to view similar products for [Ferrite Beads](#) category:

Click to view products by [Inpaq](#) manufacturer:

Other Similar products are found below :

[CZB1EGTTP700P](#) [CZB1JGTTD152P](#) [CZB2AFTTD800P](#) [CZB2AGTTD121P](#) [CZB2AGTTD601P](#) [CZB2BFTTE600P](#) [PE-0402FB121ST](#)
[DER0705-2.2](#) [NCB0603R301TR050F](#) [NCB-H1206B680TR300F](#) [CZB1JGTTD221P](#) [CZB1JGTTD600P](#) [CZB2AGTTD301P](#)
[CZB2BFTTE301P](#) [CZB2BFTTE601P](#) [4221R-1](#) [432703041971](#) [EMI0805R-600](#) [SBY100505T-100Y-N](#) [NCB-GH0402D121TR060F](#)
[NCB0402P301TR005F](#) [NCB0603R152TR030F](#) [NCB0805A121TR050F](#) [NCB0805A301TR070F](#) [NCB3312K900TR500F](#) [NCB-](#)
[H1206B101TR300F](#) [NCB0402P221TR030F](#) [NCB0805A102TR040F](#) [NCB1806E151TR020F](#) [NCB-H0402P100TR200F](#) [NCB-](#)
[H0603R121TR300F](#) [NCB-H0805A220TR600F](#) [NCB-H1206B601TR200F](#) [CZB1JGTTD202P](#) [CBH160808W221T](#) [EMI1206R-600](#)
[WLBD2012HCU121TH](#) [WLBD2012HCU221TH](#) [WQBD1608HCU121TH](#) [WLBD1608K2U800TP](#) [74279230](#) [BMB2A0080AN4](#)
[SZ1608F470TF](#) [FBSHC0805-331-302R](#) [HFJ100505T-601Y-N](#) [HFY100505T-221Y-N](#) [SBY060303T-121Y-N](#) [BBPY00160808301Y00](#)
[SBY100505T-750Y-N](#) [BBPY00100505102Y00](#)