

# Product Engineering Specification

## MLC106033R0V12A0

### 1 Scope

This specification is applied to electrostatic discharge (ESD) protection. It is designed to protect the high-speed data lines against ESD transients. It has very low capacitance and fast turn on times makes it ideal for data and transmission lines with high data rates. According to the special property of device, we recommend not to use on such application as: DC/AC power line.

For RoHS Compliance.

#### Feature

- Protection against ESD voltages and currents (IEC61000-4-2 Level 4)
- Extremely quick response time (<1ns) present ideal ESD protection
- Extremely low capacitance (3 pF typical)
- Extremely low leakage current
- Bi-directional device
- SMD (Surface Mount Device)
- Zero signal distortion

### Applications

MLC106033R0V12A0 is applied to high speed signal interface.

- Antenna circuit
- USB2.0
- IEEE-1394
- DVI
- HDMI

### Product Model

- Digital Video Equipment
- Mobile Phone
- GPS Antenna
- Bluetooth Communication Equipment

UNLESS OTHER SPECIFIED TOLERANCES ON : X=±      X.X=±      X.XX=± ANGLES=±      HOLEDIA=±			<b>INPAQ TECHNOLOGY CO., Ltd</b>	
SCALE : XXXX	UNIT : XXXX			
DRAWN BY : 張芳榕	CHECKED BY : 古國芳	THIS DRAWINGS AND SPECIFICATIONS ARE THE PROPERTY OF INPAQ TECHNOLOGY CO.,LTD.AND SHALL NOT BE REPRODUCED OR USED AS THE BASIS FOR THE MANUFACTURE OR SALE OF APPARATUS OR DEVICES WITHOUT PERMISSION		
DESIGNED BY : 劉兆芳	APPROVED BY : 張育嘉			
TITLE:MLC106033R0V12A0 Engineering Specification		DOCUMENT NO.	<b>ENS000041460</b>	SPEC REV. <b>P0</b>

## 2 Explanation of Part Number

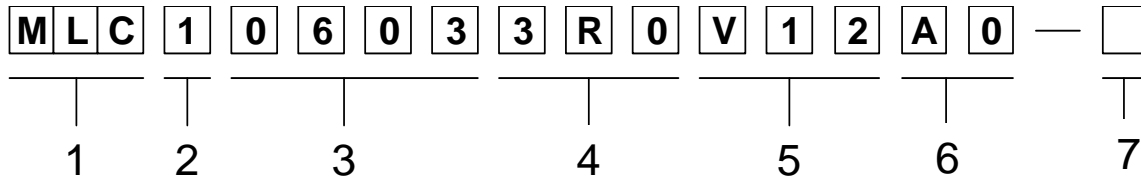

- 1 : MLC:ultra low capacitance
- 2 : Single element
- 3 : Chip size, EIA 0603
- 4 : Capacitance:  
 Value- $XRX=0.XpF$ , Ex:3R0=3pF;  
 $XX \times 10^N$ ?  $XXN$ , Ex:10pF= $10 \times 10^0$ ? 100
- 5 : Max rated voltage, VDC
- 6 : "A0" : Model Code
- 7 : Suffix for Special Code

## 3 Circuit symbol



UNLESS OTHER SPECIFIED TOLERANCES ON :			<b>INPAQ TECHNOLOGY CO., Ltd</b>	
$X=\pm$	$X.X=\pm$			
ANGLES= $\pm$		HOLEDIA= $\pm$		
SCALE : XXXX	UNIT : XXXX			
DRAWN BY : 張芳榕	CHECKED BY : 古國芳			
DESIGNED BY : 劉兆芳	APPROVED BY : 張育嘉			
TITLE:MLC106033R0V12A0 Engineering Specification		DOCUMENT NO.	<b>ENS000041460</b>	SPEC REV. <b>P0</b>

### 4 Construction & Dimensions

- 4.1 Substrate : Ceramic (Alumina)
- 4.2 Encapsulate : Polymer
- 4.3 End termination : Ag/Ni/Sn
- 4.4 Construction & Dimension :

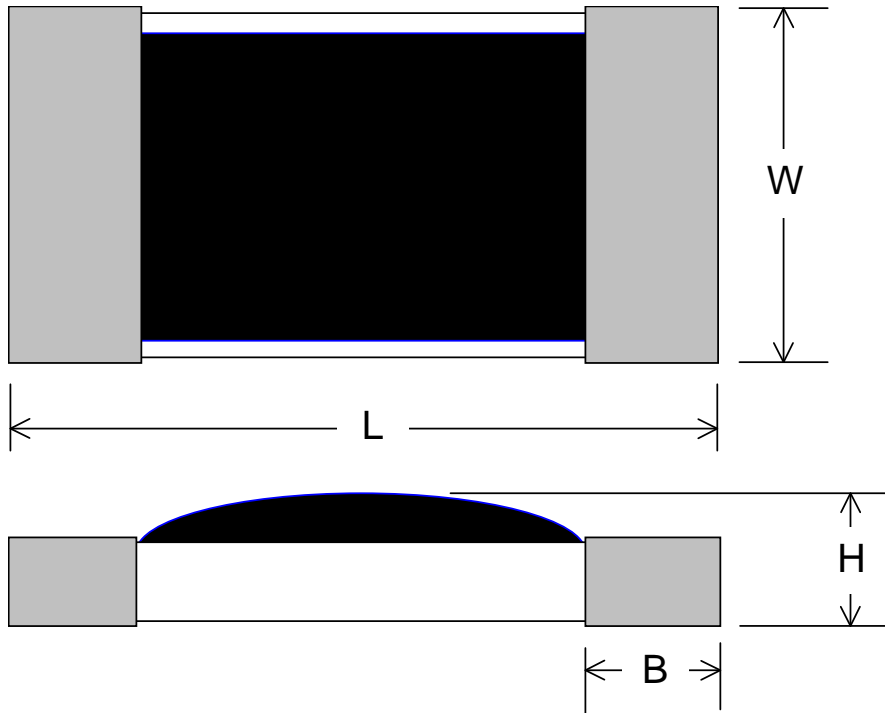

Unit: mm

L	W	H	B
1.6±0.1	0.8±0.1	0.5±0.1	0.3±0.2

UNLESS OTHER SPECIFIED TOLERANCES ON :

X=±      X.X=±      X.XX=±  
 ANGLES=±      HOLEDIA=±



INPAQ TECHNOLOGY CO., Ltd

SCALE : XXXX      UNIT : XXXX

DRAWN BY : 張芳榕      CHECKED BY : 古國芳  
 DESIGNED BY : 劉兆芳      APPROVED BY : 張育嘉

THIS DRAWINGS AND SPECIFICATIONS ARE THE PROPERTY OF INPAQ TECHNOLOGY CO.,LTD.AND SHALL NOT BE REPRODUCED OR USED AS THE BASIS FOR THE MANUFACTURE OR SALE OF APPARATUS OR DEVICES WITHOUT PERMISSION

TITLE:MLC106033R0V12A0 Engineering Specification

DOCUMENT NO.

ENS000041460

SPEC REV.  
P0

### 5 Performance Characteristics

	Symbol	Unit	Min.	Typical	Max.
Rated voltage	VDC	V			12
Leakage current	I <sub>L</sub>	μA		0.05	
Trigger voltage	V <sub>t</sub>	V		300	
Clamping voltage	V <sub>c</sub>	V		50	
Capacitance, @1MHz	C <sub>p</sub>	pF		3	5
Response time		ns			1
ESD voltage capability, Contact discharge mode		kV		8	
ESD voltage capability, Air discharge mode		kV		15	
ESD pulse withstand		pulses		1000	

V<sub>t</sub> – measurement by using Transmission Line Pulse (TLP)

V<sub>c</sub> – measurement by using Transmission Line Pulse (TLP)

C<sub>p</sub> – Device capacitance measured with 1Vrms

UNLESS OTHER SPECIFIED TOLERANCES ON : X=±      X.X=±      X.XX=± ANGLES=±      HOLEDIA=±			INPAQ TECHNOLOGY CO., Ltd
SCALE : XXXX	UNIT : XXXX		
DRAWN BY : 張芳榕	CHECKED BY : 古國芳	THIS DRAWINGS AND SPECIFICATIONS ARE THE PROPERTY OF INPAQ TECHNOLOGY CO.,LTD.AND SHALL NOT BE REPRODUCED OR USED AS THE BASIS FOR THE MANUFACTURE OR SALE OF APPARATUS OR DEVICES WITHOUT PERMISSION	
DESIGNED BY : 劉兆芳	APPROVED BY : 張育嘉		
TITLE:MLC106033R0V12A0 Engineering Specification		DOCUMENT NO.	ENS000041460
			SPEC REV. P0

## 6 General specifications

### 6.1 Temperature Specifications

Operating Temperature range : -40°C to +85°C

Storage Temperature range : -55°C to +125°C

### 6.2 Environmental Specifications

Item	Specifications	Test condition	Reference
Bias humidity	$I_L \leq 10 \mu A$	90%RH, 40°C, rated voltage 5VDC, 1000 hrs	MIL-STD-202 Method 103
Thermal Shock	$I_L \leq 10 \mu A$	-40°C to 85°C, 30 min. cycle, 5 cycles	JIS C 0025 (1998) Test Na
High Temperature load voltage	$I_L \leq 10 \mu A$	Rated voltage, 85°C, 1000 hrs	MIL-STD-202G Method 108
Solder leach resistance	$I_L \leq 10 \mu A$	260°C, 10s	MIL-STD-202G Method 210F

$I_L$  – Leakage current at rated voltage, the maximum leakage current was measured after reliability test.

UNLESS OTHER SPECIFIED TOLERANCES ON : X=±      X.X=±      X.XX=± ANGLES=±      HOLEDIA=±			INPAQ TECHNOLOGY CO., Ltd	
SCALE : XXXX	UNIT : XXXX			
DRAWN BY : 張芳榕	CHECKED BY : 古國芳	THIS DRAWINGS AND SPECIFICATIONS ARE THE PROPERTY OF INPAQ TECHNOLOGY CO.,LTD.AND SHALL NOT BE REPRODUCED OR USED AS THE BASIS FOR THE MANUFACTURE OR SALE OF APPARATUS OR DEVICES WITHOUT PERMISSION		
DESIGNED BY : 劉兆芳	APPROVED BY : 張育嘉			
TITLE:MLC106033R0V12A0 Engineering Specification		DOCUMENT NO.	ENS000041460	SPEC REV.
				P0

## 7. Taping Package and Label Marking

### 7.1 Packaging method

7.1.1 Products shall be heat-sealed in the chip pocket, spacing pitch 2-mm of paper carrier tape with cover tape, and the carrier tape shall be reeled to the reel.

7.1.2 Tape material to be paper. Tape thickness to be  $0.60 \pm 0.05$  mm.

7.1.3 Cover tape adhesion to be  $40 \pm 15$  grams.

### 7.2 Carrier tape dimensions

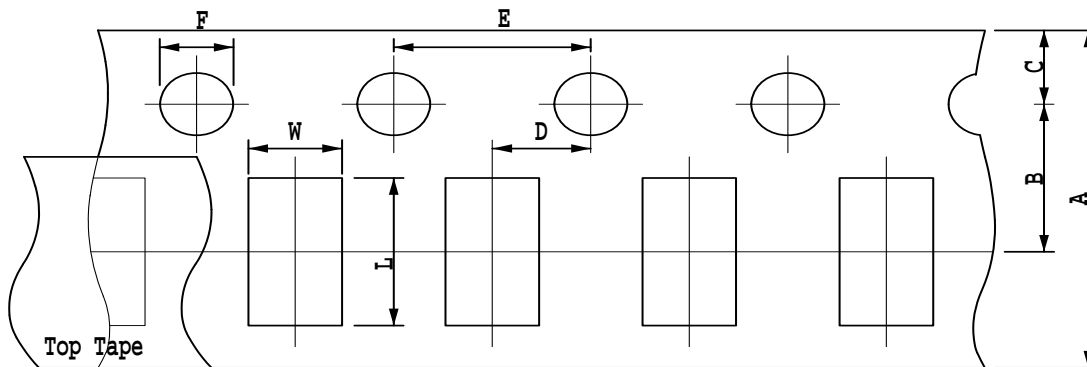

Unit: mm

	0603
A	$8.00 \pm 0.30$
B	$3.50 \pm 0.05$
C	$1.75 \pm 0.10$
D	$2.00 \pm 0.05$
E	$4.00 \pm 0.10$
F	$1.50 \pm 0.10$
L	$1.90 \pm 0.20$
W	$1.10 \pm 0.20$

UNLESS OTHER SPECIFIED TOLERANCES ON :

X=±      X.X=±      X.XX=±

ANGLES=±      HOLEDIA=±



INPAQ TECHNOLOGY CO., Ltd

SCALE : XXXX

UNIT : XXXX

DRAWN BY : 張芳榕

CHECKED BY : 古國芳

DESIGNED BY : 劉兆芳

APPROVED BY : 張育嘉

THIS DRAWINGS AND SPECIFICATIONS ARE THE PROPERTY OF INPAQ TECHNOLOGY CO.,LTD.AND SHALL NOT BE REPRODUCED OR USED AS THE BASIS FOR THE MANUFACTURE OR SALE OF APPARATUS OR DEVICES WITHOUT PERMISSION

TITLE:MLC106033R0V12A0 Engineering Specification

DOCUMENT NO.

ENS000041460

SPEC REV.  
P0

### 7.3 Taping reel dimensions

Unit: mm

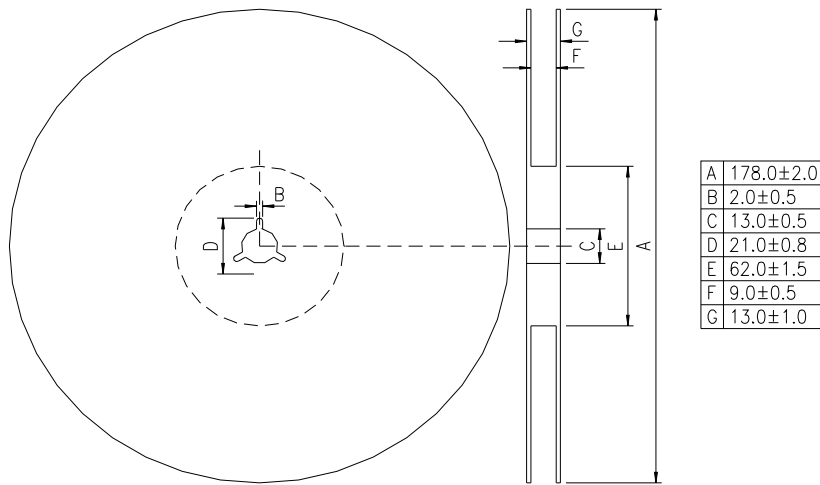

### 7.4 Taping specifications

There shall be the portion having no product in both the head and the end of taping, and there shall be the cover tape in the head of taping.

### 7.5 Label Marking

The label specified as follows shall be put on the side of reel.

- (1) Part No.
- (2) Quantity
- (3) Lot No.

\* Part No. And Quantity shall be marked on outer packaging.

### 7.6 Quantity of products in the taping package

- (1) Standard quantity : 5000pcs/Reel
- (2) Shipping quantity is a multiple of standard quantity.

UNLESS OTHER SPECIFIED TOLERANCES ON : X=±      X.X=±      X.XX=± ANGLES=±      HOLEDIA=±			INPAQ TECHNOLOGY CO., Ltd	
SCALE : XXXX	UNIT : XXXX			
DRAWN BY : 張芳榕	CHECKED BY : 古國芳	THIS DRAWINGS AND SPECIFICATIONS ARE THE PROPERTY OF INPAQ TECHNOLOGY CO.,LTD.AND SHALL NOT BE REPRODUCED OR USED AS THE BASIS FOR THE MANUFACTURE OR SALE OF APPARATUS OR DEVICES WITHOUT PERMISSION		
DESIGNED BY : 劉兆芳	APPROVED BY : 張育嘉			
TITLE:MLC106033R0V12A0 Engineering Specification		DOCUMENT NO.	ENS000041460	SPEC REV. P0

### 8. Precautions for Handling

#### 8.1 Solder cream in reflow soldering

Refer to the recommendable land pattern as printing mask pattern for solder cream.

- (1) Print solder in a thickness of 0.15 to 0.2 mm.

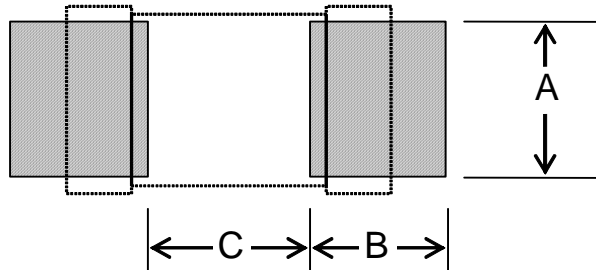

Unit : mm(inch)

A	0.75±0.1 (0.03±0.004)
B	0.75±0.1 (0.03±0.004)
C	0.75±0.1 (0.03±0.004)

#### 8.2 Precaution for handling of substrate

Do not exceed to bend the board after soldering this product extremely. (reference examples)

- Mounting place must be as far as possible from the position, which is close to the break line of board, or on the line of large holes of board.
- Do not bend extremely the board, in mounting another components. If necessary, use back-up pin (support pin) to prevent from bending extremely.
- Do not break the board by hand. We recommend to use the machine or the jig to break it.

UNLESS OTHER SPECIFIED TOLERANCES ON : X=±      X.X=±      X.XX=± ANGLES=±      HOLEDIA=±		 <p><b>INPAQ TECHNOLOGY CO., Ltd</b></p>	
SCALE : XXXX	UNIT : XXXX		
DRAWN BY : 張芳榕	CHECKED BY : 古國芳	THIS DRAWINGS AND SPECIFICATIONS ARE THE PROPERTY OF INPAQ TECHNOLOGY CO.,LTD.AND SHALL NOT BE REPRODUCED OR USED AS THE BASIS FOR THE MANUFACTURE OR SALE OF APPARATUS OR DEVICES WITHOUT PERMISSION	
DESIGNED BY : 劉兆芳	APPROVED BY : 張育嘉		
TITLE:MLC106033R0V12A0 Engineering Specification		DOCUMENT NO. <b>ENS000041460</b>	SPEC REV. <b>P0</b>



### 8.3 Precaution for soldering

Note that this product will be easily damaged by rapid heating, rapid cooling or local heating.

Do not give heat shock over 100°C in the process of soldering. We recommend to take preheating and gradual cooling.

### 8.4 Recommendable reflow soldering

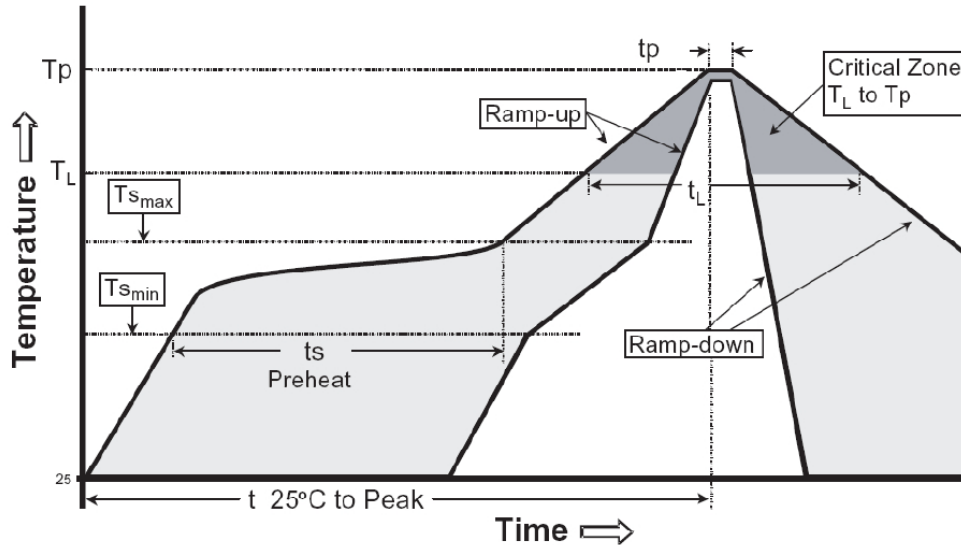

Reference IPC-020c-5-1

Profile Feature	Pb free Assembly
Average Ramp Rate (Ts max to Tp)	3 °C/second max
Preheat	
- Temperature Min (Ts <sub>min</sub> )	150°C
- Temperature Min (Ts <sub>max</sub> )	200°C
- Time(ts <sub>min</sub> to ts <sub>min</sub> )	60-180 seconds
Time maintained above:	
- Temperature (T <sub>L</sub> )	217°C
- Time (t <sub>L</sub> )	60-150 seconds
Peak Temperature (T <sub>p</sub> )	260°C +0/-5 °C
Time within 5 °C of actual Peak Temperature (T <sub>p</sub> )	20-40 seconds
Ramp-Down Rate	6 °C/second max.
Time 25°C to Peak Temperature	8 minutes max

UNLESS OTHER SPECIFIED TOLERANCES ON :

X=±      X.X=±      X.XX=±

ANGLES=±      HOLEDIA=±



INPAQ TECHNOLOGY CO., Ltd

SCALE : XXXX

UNIT : XXXX

DRAWN BY : 張芳榕

CHECKED BY : 古國芳

DESIGNED BY : 劉兆芳

APPROVED BY : 張育嘉

THIS DRAWINGS AND SPECIFICATIONS ARE THE PROPERTY OF INPAQ TECHNOLOGY CO.,LTD.AND SHALL NOT BE REPRODUCED OR USED AS THE BASIS FOR THE MANUFACTURE OR SALE OF APPARATUS OR DEVICES WITHOUT PERMISSION

TITLE:MLC106033R0V12A0 Engineering Specification

DOCUMENT NO.

ENS000041460

SPEC REV. P0

**8.5 Soldering gun procedure**

Note the follows, in case of using solder gun for replacement.

- (1) The tip temperature must be less than 280°C for the period within 3 seconds by using soldering gun under 30 W.
- (2) The soldering gun tip shall not touch this product directly.

**8.6 Soldering volume**

Note that excess of soldering volume will easily get crack the body of this product.

**8.7 Taping Package Storage Condition**

Storage Temperature : 5 to 40 °C

Relative Humidity: < 65%RH

Storage Time : 12 months max

UNLESS OTHER SPECIFIED TOLERANCES ON : X=±      X.X=±      X.XX=± ANGLES=±      HOLEDIA=±			INPAQ TECHNOLOGY CO., Ltd	
SCALE : XXXX	UNIT : XXXX			
DRAWN BY : 張芳榕	CHECKED BY : 古國芳	THIS DRAWINGS AND SPECIFICATIONS ARE THE PROPERTY OF INPAQ TECHNOLOGY CO.,LTD.AND SHALL NOT BE REPRODUCED OR USED AS THE BASIS FOR THE MANUFACTURE OR SALE OF APPARATUS OR DEVICES WITHOUT PERMISSION		
DESIGNED BY : 劉兆芳	APPROVED BY : 張育嘉			
TITLE:MLC106033R0V12A0 Engineering Specification		DOCUMENT NO.	ENS000041460	SPEC REV.
				P0

## X-ON Electronics

Largest Supplier of Electrical and Electronic Components

*Click to view similar products for [ESD Suppressors / TVS Diodes](#) category:*

*Click to view products by [Inpaq](#) manufacturer:*

Other Similar products are found below :

[NTE4902](#) [P4SMAJ15A](#) [P4SMAJ26A](#) [SMAJ400CA-TP](#) [TGL34-47CA](#) [ESDAULC45-1BF4](#) [SM1605E3/TR13](#) [SMF20A-TP](#) [P4SMAJ12A](#)  
[CPDUR24V-HF](#) [CPDQC5V0USP-HF](#) [CPDQC5V0-HF](#) [MPLAD30KP280A](#) [MPLAD30KP45CAE3](#) [MMBZ27VCLQ-7-F](#) [MMAD1108/TR13](#)  
[MPLAD30KP24A](#) [MPLAD30KP30CAE3](#) [ACPDQC5V0R-HF](#) [DFLT170A-7](#) [NTE4900](#) [NTE4926](#) [NTE4938](#) [JANTX1N6144A](#)  
[JANTX1N6057A](#) [SMF22A-TP](#) [SMF12A-TP](#) [SLVU2.8-TP](#) [SMLJ6.5CA-TP](#) [SMAJ6.5CA-TP](#) [MMAD1108E3/TR13](#) [JANTX1N6160A](#)  
[D5V0M1U2LP3-7](#) [SMAJ400A-TP](#) [AOZ8811DT-03](#) [AOZ8831DI-05](#) [AOZ8831DT-03](#) [SMAJ188CA](#) [3SMC33CA BK](#) [CPDQC3V3C-HF](#)  
[CPDQC12VE-HF](#) [GRPADATAJANTX1N6041A](#) [MPLAD30KP170CA](#) [82357120100](#) [5.0SMLJ15CA-TP](#) [5KP18A-TP](#) [P6KE8.2A-TP](#)  
[MPLAD30KP43CAE3](#) [SMAJ43A-TP](#) [D26V0H1U2LP16-7](#)