

# 10/100/1000BASE-T SINGLE & DUAL-PORT TRANSFORMER MODULES

Military / Aerospace Grade

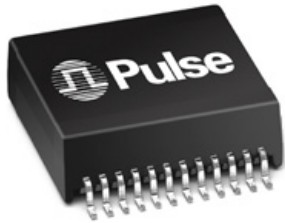
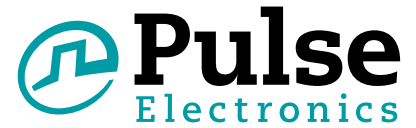

- Compliant with IEEE 802.ab for 1000Base-T
- 350µH OCL with 8mA bias at extended temperatures
- Two Operating and Storage Temperature Versions Available:
  - Standard: -40°C to +85°C
  - Extended: -55°C to +125°C
- IC grade transfer molded package 235°C peak reflow temperature for non-RoHS versions (MSL 3)
- 245°C peak reflow temperature for RoHS versions (MSL 4)
- Lead finish: Sn63/Pb37 (RoHS compliant version available with 100% pure tin)

## Electrical Specifications @ 25°C — Operating Temperature -40°C to +85°C

Part Number <sup>2</sup>	Insertion Loss (dB Min)	Return Loss (dB Max)					Crosstalk (dB Max)			CM to CM Rejection Ratio (dB Max)			DM to CM Rejection Ratio (dB Max)			Hipot (Vrms)
		0.1-100 Mhz	30 Mhz	60 Mhz	80 Mhz	100 Mhz	30 Mhz	60 Mhz	100 Mhz	30 Mhz	60 Mhz	100 Mhz	30 Mhz	60 Mhz	100 Mhz	
1000B-5009F	-1.2	-18	-12	-12	-10	-43	-37	-31	-30	-25	-18	-40	-35	-30	1500	
1000B-5012F	-1	-18	-12	-12	-10	-43	-37	-33	-43	-37	-33	-43	-37	-33	1500	
1000B-5014F	-1.4	-16	-12	-12	-10	-43	-37	-33	-45	-40	-35	-43	-37	-33	1500	
1000B-5016F	-1.2	-18	-12	-12	-10	-43	-37	-31	-30	-23	-17	-40	-35	-30	1500	

Note: 1. Add suffix X for extended temperature version; i.e. 1000B-5009F becomes 1000B-5009FX. 2. Add suffix NL for RoHS compliant part; i.e. 1000B-5012F becomes 1000B-5012FNL. 3. For Tape & Reel Packaging, add "T" suffix at the end of the part number; i.e. 1000B-5014FT

## Mechanicals

### 1000B-5009F/X

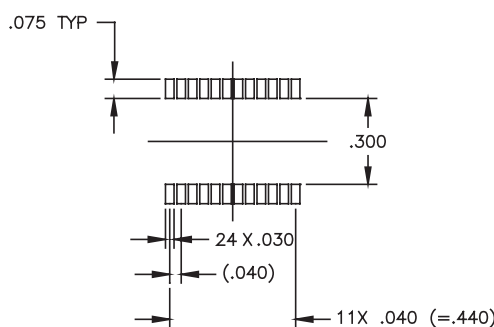
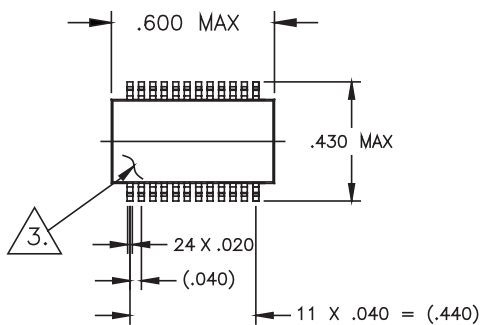

Weight ..... 0.75 grams  
 Tape and Reel ..... 250/reel  
 Tube ..... 15/tube

Dimensions:  $\frac{\text{Inches}}{\text{mm}}$   
 Unless otherwise specified, all tolerances are  $\pm \frac{.010}{0,25}$

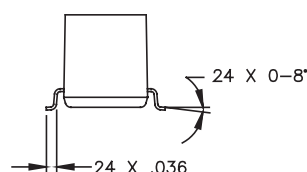
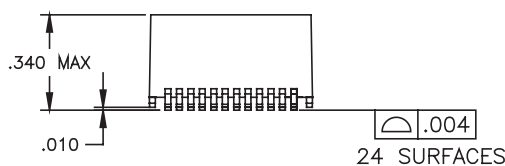

# 10/100/1000BASE-T SINGLE & DUAL-PORT TRANSFORMER MODULES

Military / Aerospace Grade

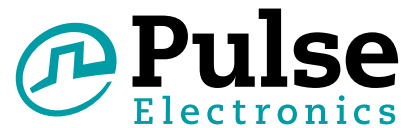

## 1000B-5012F/X

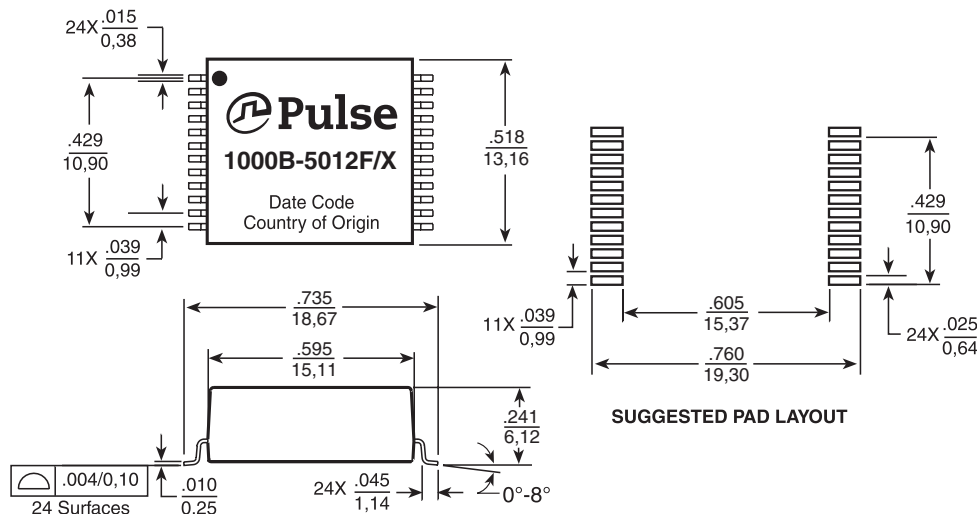

Weight ..... 3.5 grams  
Tape and Reel ..... 250/reel  
Tube ..... 15/tube

Dimensions:  $\frac{\text{Inches}}{\text{mm}}$   
Unless otherwise specified,  
all tolerances are  $\pm \frac{.010}{0,25}$

## 1000B-5014F/X

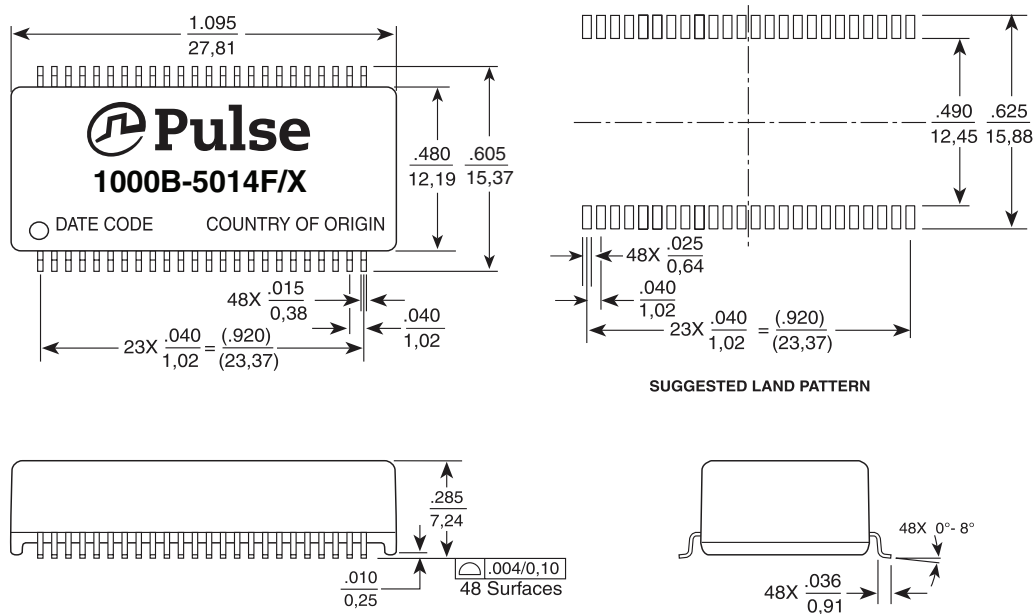

Weight ..... 3.0 grams  
Tape and Reel ..... 300/reel  
Tube ..... .25/tube

Dimensions:  $\frac{\text{Inches}}{\text{mm}}$   
Unless otherwise specified,  
all tolerances are  $\pm \frac{.010}{0,25}$

# 10/100/1000BASE-T SINGLE & DUAL-PORT TRANSFORMER MODULES

Military / Aerospace Grade

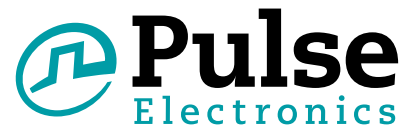

## 1000B-5016F/X

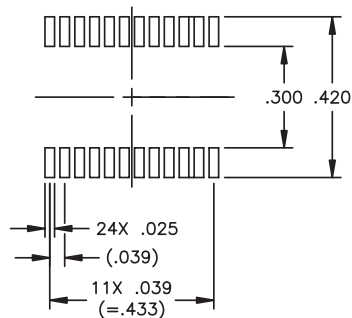
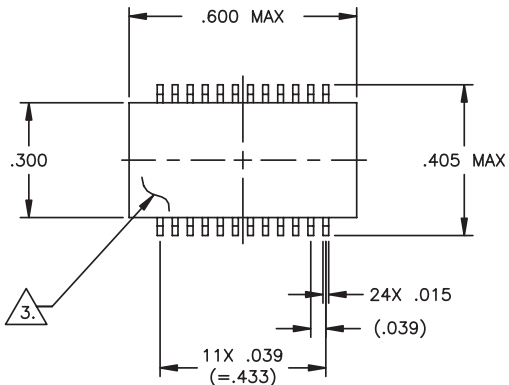

Weight ..... 0.75 grams  
 Tape and Reel ..... 700/reel  
 Tube ..... .30/tube

Dimensions: Inches  
                   mm  
 Unless otherwise specified,  
 all tolerances are  $\pm \frac{.010}{0.25}$

SUGGESTED LAND PATTERN

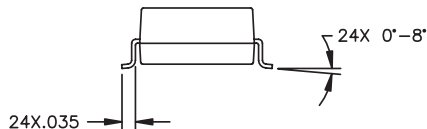
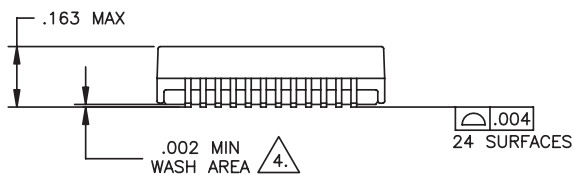

# 10/100/1000BASE-T SINGLE & DUAL-PORT TRANSFORMER MODULES

Military / Aerospace Grade

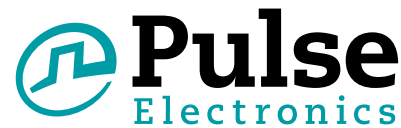

## Electrical Schematics

1000B-5009F/X

### CHANNEL 1

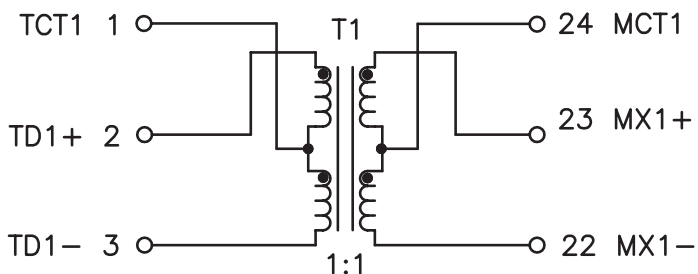

### CHANNEL 2

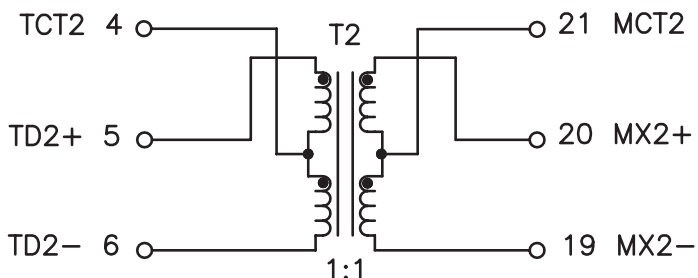

### CHANNEL 3

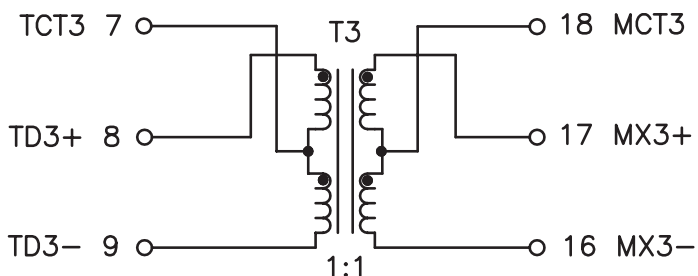

### CHANNEL 4

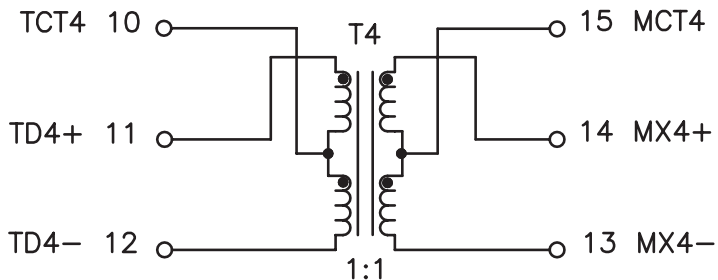

### LEGEND

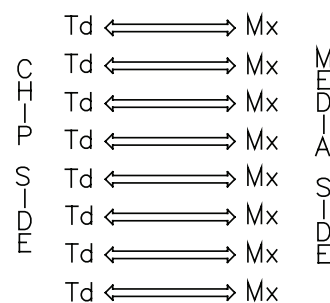

# 10/100/1000BASE-T SINGLE & DUAL-PORT TRANSFORMER MODULES

Military / Aerospace Grade



1000B-5012F/X

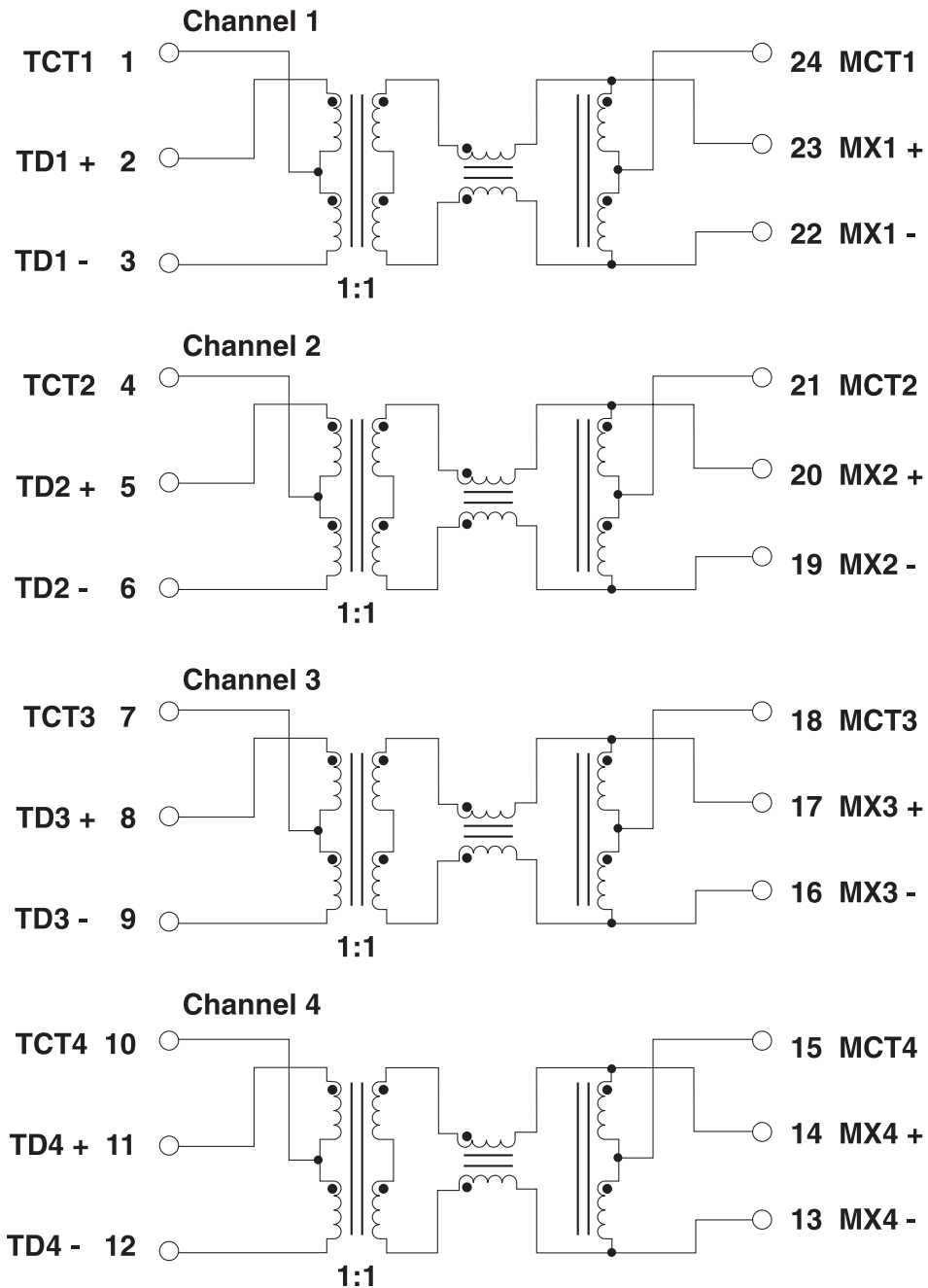

### LEGEND

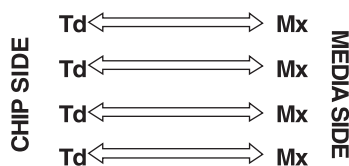

# 10/100/1000BASE-T SINGLE & DUAL-PORT TRANSFORMER MODULES

Military / Aerospace Grade

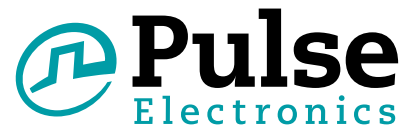

1000B-5014F/X

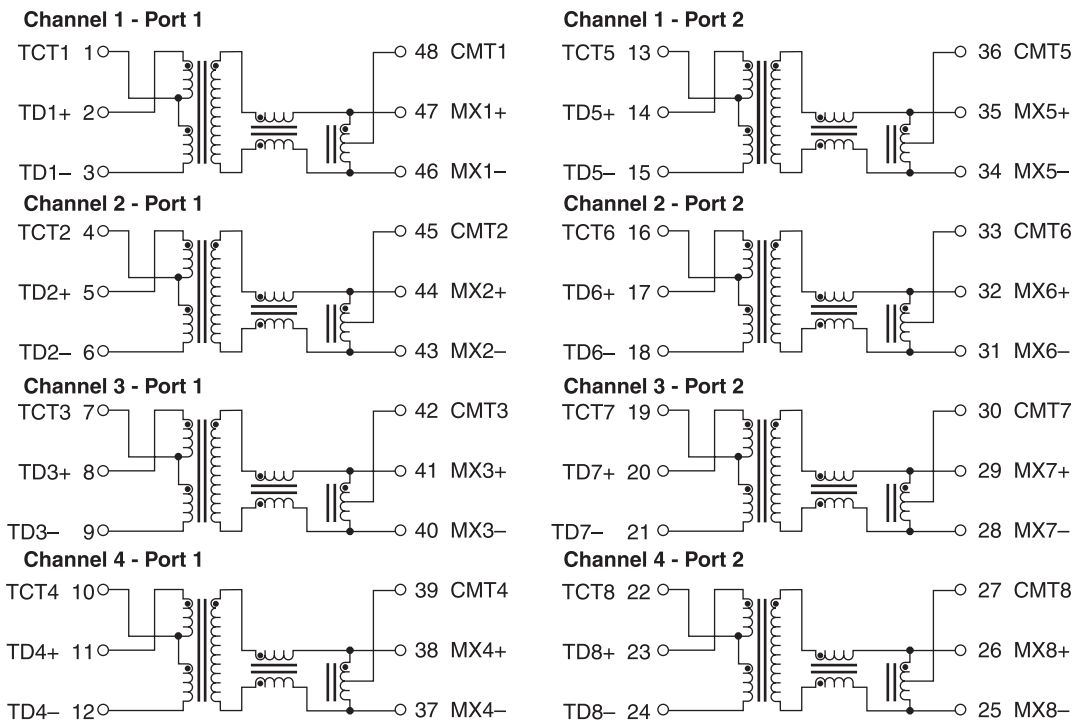

## LEGEND

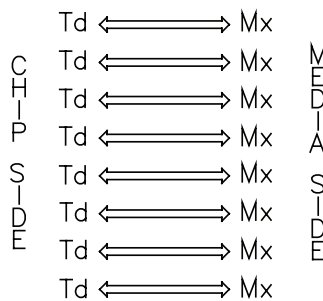

ALL CHANNELS ARE IN PHASE BETWEEN INPUT AND OUTPUT

# 10/100/1000BASE-T SINGLE & DUAL-PORT TRANSFORMER MODULES

Military / Aerospace Grade

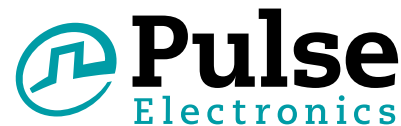

## 1000B-5016F/X

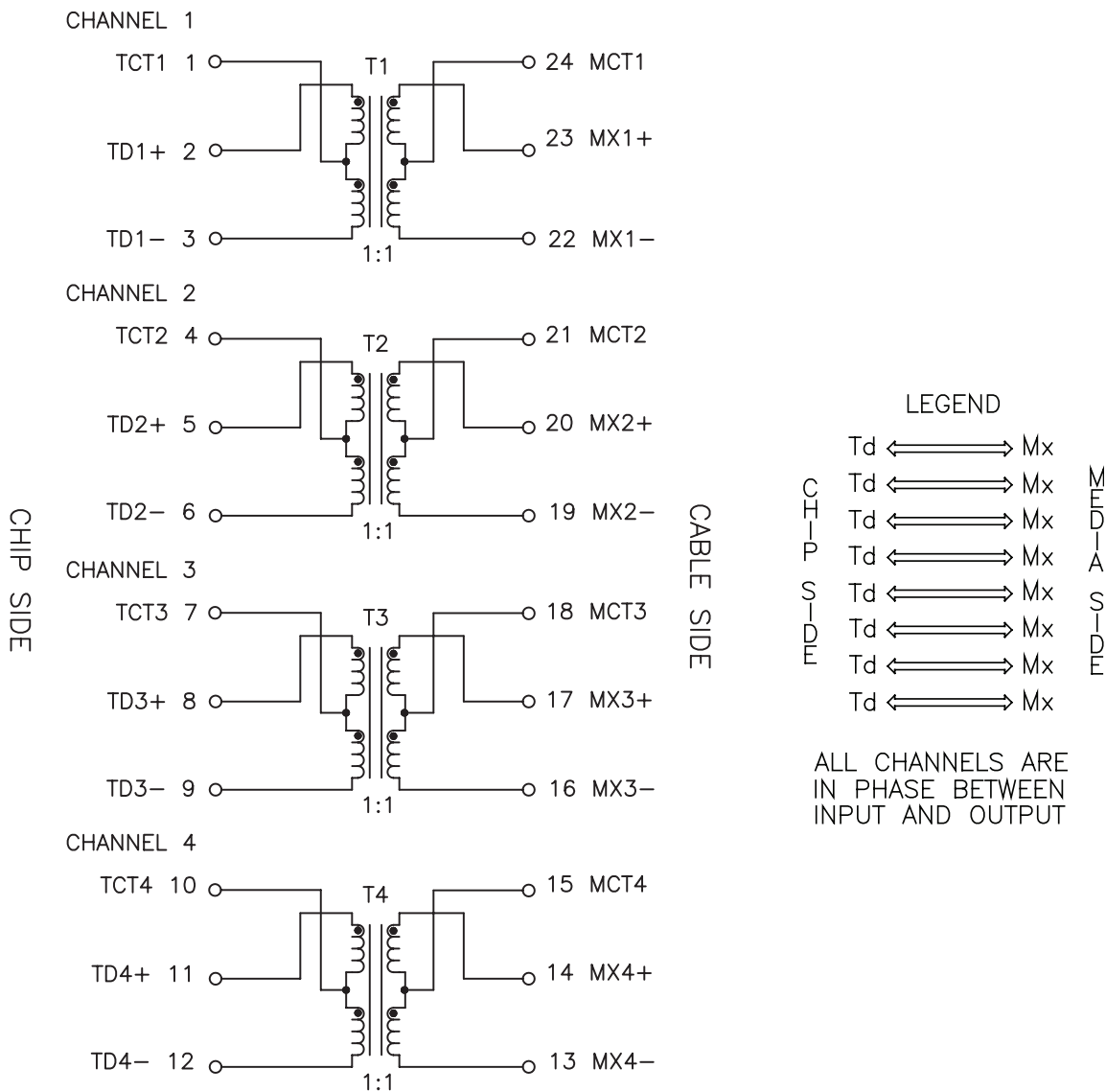

### For More Information

#### Pulse Worldwide Headquarters

Two Pearl Buck Court  
Bristol, PA 19007  
U.S.A.

Tel: 215 781 6400  
Fax: 215 781 6403

#### Pulse Europe

Einsteinstrasse 1  
D-71083 Herrenberg  
Germany

Tel: 49 7032 7806 0  
Fax: 49 7032 7806 135

#### Pulse China Headquarters

B402, Shenzhen Academy of  
Aerospace Technology Bldg.  
10th Kejinan Road  
High-Tech Zone  
Nanshan District  
Shenzhen, PR China 518057

Tel: 86 755 33966678  
Fax: 86 755 33966700

#### Pulse North China

Room 2704/2705  
Super Ocean Finance Ctr.  
2067 Yan An Road West  
Shanghai 200336  
China

Tel: 86 21 62787060  
Fax: 86 2162786973

#### Pulse South Asia

135 Joo Seng Road  
#03-02  
PM Industrial Bldg.  
Singapore 368363

Tel: 65 6287 8998  
Fax: 65 6287 8998

#### Pulse North Asia

3F, No. 198  
Zhongyuan Road  
Zhongli City  
Taoyuan County 320  
Taiwan R. O. C.

Tel: 886 3 4356768  
Fax: 886 3 4356823 (Pulse)  
Fax: 886 3 4356820 (FRE)

Performance warranty of products offered on this data sheet is limited to the parameters specified. Data is subject to change without notice. Other brand and product names mentioned herein may be trademarks or registered trademarks of their respective owners. © Copyright, 2012. Pulse Electronics, Inc. All rights reserved.

## X-ON Electronics

Largest Supplier of Electrical and Electronic Components

*Click to view similar products for [Audio Transformers](#) / [Signal Transformers](#) category:*

*Click to view products by [iNRCORE](#) manufacturer:*

Other Similar products are found below :

[CX2041NLT](#) [MGPWT-00449-P](#) [PE-64961](#) [H1302FNLT](#) [H5008FNL](#) [H5012FNL](#) [H5020FNLT](#) [H5077NLT](#) [H5079NLT](#) [H5084FNLT](#)  
[B78476A9558A003](#) [1812WBT2-4](#) [1879479-1](#) [HX2260FNL](#) [HX5014FNL](#) [EX2024FNL](#) [FL1066](#) [T1137NLT](#) [T3012NL](#) [PE-65812FNL](#) [PE-65848FNLT](#) [H1174FNL](#) [H1302FNL](#) [H5015FNL](#) [H5019EFNL](#) [H5062FNLT](#) [CX2047LNL](#) [MGPWT-00059-P](#) [MGPWT-00266-P](#) [MGPWT-00278-P](#) [MGPWT-00431-P](#) [TTC-100](#) [TTC-143-H](#) [TTC-5032-1](#) [BX1194WNLT](#) [HX1234NLT](#) [HX5008FNLT](#) [HX5019FNL](#) [HX5084NL](#) [3-1879385-5](#) [TX1263NLT](#) [4-1879391-0](#) [T1142NL](#) [HX6101FNL](#) [HX5084FNL](#) [HX1148NL](#) [HX5020FNLT](#) [HX5014FNLT](#) [T1124NL](#)  
[1879732-1](#)