





T1/E1/CEPT/ISDN-PRI SMT TRANSFORMERS



-  Pick and place compatible
-  Isolation voltage: 1500Vrms minimum
-  Extended temperature range: -55°C to +125°C
-  Tape and Reel packaging available

Electrical Specifications @ 25°C — Operating Temperature -55°C to +125°C

Part Number	Turns Ratio (Pri:Sec ±2%)	OCL Pri @ 25°C (mH MIN)	C _{ww} (pF MAX)	DCR Pri (Ω MAX)	Primary Pins
PL1374	1CT:1CT	1.2	35	0.8	1-3

Mechanical

Schematics

PL1374

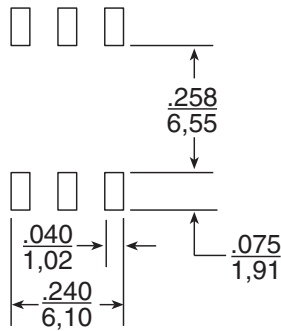
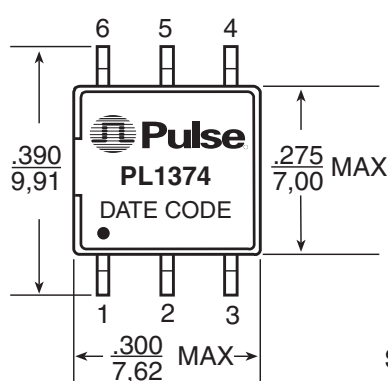

SUGGESTED PAD LAYOUT

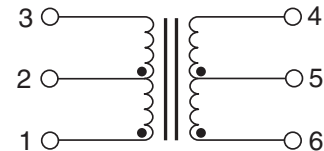
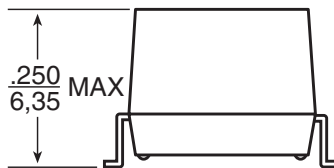
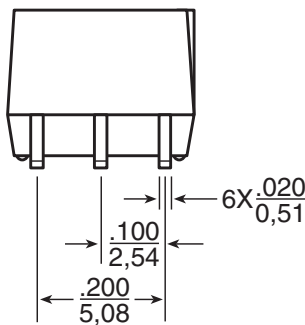

Weight0.6 grams
 Tape & Reel500/reel
 Tube70/tube
 Dimensions: $\frac{\text{Inches}}{\text{mm}}$
 Unless otherwise specified,
 all tolerances are $\pm \frac{.010}{0,25}$

For More Information:

Pulse Worldwide Headquarters

2 Pearl Buck Court
 Bristol, PA 19007
 U.S.A.

www.pulseeng.com

TEL: 215 781 6400

FAX: 215 781 6403

Pulse Europe

Einsteinstrasse 1
 D-71083 Herrenberg
 Germany

Tel: 49 7032 7806 116

Fax: 49 7032 7806 135

Pulse China Headquarters

No. 1
 Industrial District
 Changan, Dongguan
 China

Tel: 86 769 85538070

Fax: 86 769 85538870

Pulse North China

Room 1503
 XinYin Building
 No. 888 YiShan Rd.
 Shanghai 200233
 China

Tel: 86 21 54643211/2

Fax: 86 21 54643210

Pulse South Asia

150 Kampong Ampat
 #07-01/02
 KA Centre
 Singapore 368324

Tel: 65 6287 8998

Fax: 65 6280 0080

Pulse North Asia

No. 26
 Kao Ching Rd.
 Yang Mei Chen
 Taoyuan Hsien
 Taiwan, R. O. C.

Tel: 886 3 4641811

Fax: 886 3 4641911

Performance warranty of products offered on this data sheet is limited to the parameters specified. Data is subject to change without notice. Other brand and product names mentioned herein may be trademarks or registered trademarks of their respective owners.

© Copyright, 2006. Pulse Engineering, Inc. All rights reserved.

www.pulseeng.com

M119.A (7/06)

X-ON Electronics

Largest Supplier of Electrical and Electronic Components

Click to view similar products for [Audio Transformers](#) / [Signal Transformers](#) category:

Click to view products by [iNRCORE](#) manufacturer:

Other Similar products are found below :

[CX2041NLT](#) [MGPWT-00449-P](#) [PE-64961](#) [H1302FNLT](#) [H5008FNL](#) [H5012FNL](#) [H5020FNLT](#) [H5077NLT](#) [H5079NLT](#) [H5084FNLT](#)
[B78476A9558A003](#) [1812WBT2-4](#) [1879479-1](#) [HX2260FNL](#) [HX5014FNL](#) [EX2024FNL](#) [FL1066](#) [T1137NLT](#) [T3012NL](#) [PE-65812FNL](#) [PE-65848FNLT](#) [H1174FNL](#) [H1302FNL](#) [H5015FNL](#) [H5019EFNL](#) [H5062FNLT](#) [CX2047LNL](#) [MGPWT-00059-P](#) [MGPWT-00266-P](#) [MGPWT-00278-P](#) [MGPWT-00431-P](#) [TTC-100](#) [TTC-143-H](#) [TTC-5032-1](#) [BX1194WNLT](#) [HX1234NLT](#) [HX5008FNLT](#) [HX5019FNL](#) [HX5084NL](#) [3-1879385-5](#) [TX1263NLT](#) [4-1879391-0](#) [T1142NL](#) [HX6101FNL](#) [HX5084FNL](#) [HX1148NL](#) [HX5020FNLT](#) [HX5014FNLT](#) [T1124NL](#)
[1879732-1](#)