

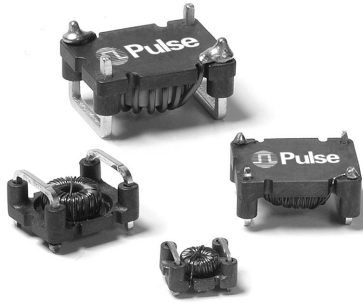



SMT POWER INDUCTORS

Toroid - Military/Aerospace SLED Series



-  Ruggedized header with SLED rails for secure board mounting
-  Four package sizes
-  **Current Rating: up to 14.3ADC**
-  **Frequency Range: up to 1MHz**

Electrical Specifications @ 25°C — Operating Temperature -55°C to +130°C

Pulse ⁴ Part Number	Inductance @ I _{rated} (μH)	I _{rated} (A)	DCR (mΩ)		Inductance @ 0ADC (μH)	Reference ET (Volt-μsec)	Flux Density Factor (K1)	Core Loss Factor (K2)	Temp. Rise Factor (K3)
			TYP	MAX					
SLED 20									
PL8100	1.01	3.40	9.35	11	1.1	0.53	5.43	3.29E-11	323.9
PL8101	6.2	1.40	59.5	70	7	1.33	2.17	3.29E-11	323.9
PL8102	17.6	1.00	106.25	125	22.7	2.4	1.21	3.29E-11	323.9
SLED 30									
PL8110	3.8	4.80	14.705	17.3	5.2	1.76	1.28	1.39E-10	148.0
PL8111	9.4	2.80	36.89	43.4	12.3	2.7	0.83	1.39E-10	148.0
PL8112	29.7	1.40	141.1	166	35.3	4.6	0.49	1.39E-10	148.0
PL8113	114	0.94	323	380	167	10	0.23	1.39E-10	148.0
SLED 40									
PL8120	2.5	8.00	7.055	8.3	3.8	1.77	1.30	1.87E-10	114.2
PL8121	5.1	5.40	15.045	17.7	7.5	2.51	0.92	1.87E-10	114.2
PL8122	16.2	2.70	63	72	21.9	4.29	0.54	1.87E-10	114.2
PL8123	58.1	1.30	246.5	290	73	7.83	0.29	1.87E-10	114.2
PL8124	192	0.90	476	560	292	15.7	0.15	1.87E-10	114.2
PL8125	383	0.72	732.7	862	672	23.5	0.10	1.87E-10	114.2
PL8130	4.9	7.80	10.54	12.4	7.9	3.04	0.67	3.35E-10	85.7
PL8131	9	5.50	25	28	14	4.06	0.51	3.35E-10	85.7
PL8132	29.1	2.70	85	100	40.5	6.9	0.30	3.35E-10	85.7
PL8133	645	0.74	1062.5	1250	1134	36.5	0.06	3.35E-10	85.7
PL8150	0.81	14.30	2.125	2.5	1.25	1.035	2.23	1.87E-10	114.2
PL8151	1.32	11.50	3.4	4.0	2.1	1.33	1.74	1.87E-10	114.2
SLED 50									
PL8140	9.3	7.20	15.895	18.7	16	4.92	0.41	4.52E-10	67.9
PL8141	16.1	5.10	27.2	32.0	25.9	6.27	0.32	4.52E-10	67.9
PL8142	50	2.60	113.05	133	72.9	10.5	0.19	4.52E-10	67.9
PL8143	1070	0.71	1445	1700	1950	54.4	0.04	4.52E-10	67.9
PL8160	1.68	13.90	3.06	3.6	2.8	1.83	1.12	3.35E-10	85.7
PL8161	2.5	11.40	4.59	5.4	4.2	2.23	0.92	3.35E-10	85.7
PL8170	3.5	12.40	5.61	6.6	6.5	3.1	0.64	4.52E-10	67.9
PL8171	4.7	10.40	7.055	8.3	8.4	3.58	0.56	4.52E-10	67.9
SLED 60									
PL8180	5.2	15.40	5.27	6.2	10.5	5.21	0.35	9.58E-10	44.6
PL8181	9.4	10.90	10.5	12.3	17.6	6.84	0.27	9.58E-10	44.6

NOTES:

- Reference values are for an inductor with a 55°C temperature rise. The core loss is 10% of the copper loss at the ET listed and 500kHz.
- Core does not saturate abruptly. The ET and DC current are limited by the desired inductance and temperature rise.
- In high volt-time applications, additional heating in the component can occur due to core losses in the inductor which may necessitate derating the current in order to limit the temperature rise of the component. In order to determine the approximate total losses (or temperature rise) for a given application, both copper and core losses should be taken into account.

Estimated Temperature Rise:

$$\text{Trise} = K3 * (\text{CoreLoss}(W) + \text{CopperLoss}(W))^{.833} (C)$$

$$\text{CopperLoss} = \text{Irms}^2 * \text{DCR_Typical} (m\Omega) / 1000$$

$$\text{CoreLoss} = K2 * (\text{Freq_kHz})^{1.26} * (\Delta B)^{2.11}$$

$$\Delta B = K1 * \text{Volt-}\mu\text{sec} * 100$$

- Optional Tape & Reel packaging can be ordered by adding a "T" suffix to the part number (i.e. PL8100 becomes PL8100T). Pulse complies to industry standard tape and reel specification EIA481.

SMT POWER INDUCTORS

Toroid - Military/Aerospace SLED Series



Mechanical

Schematic

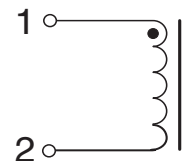
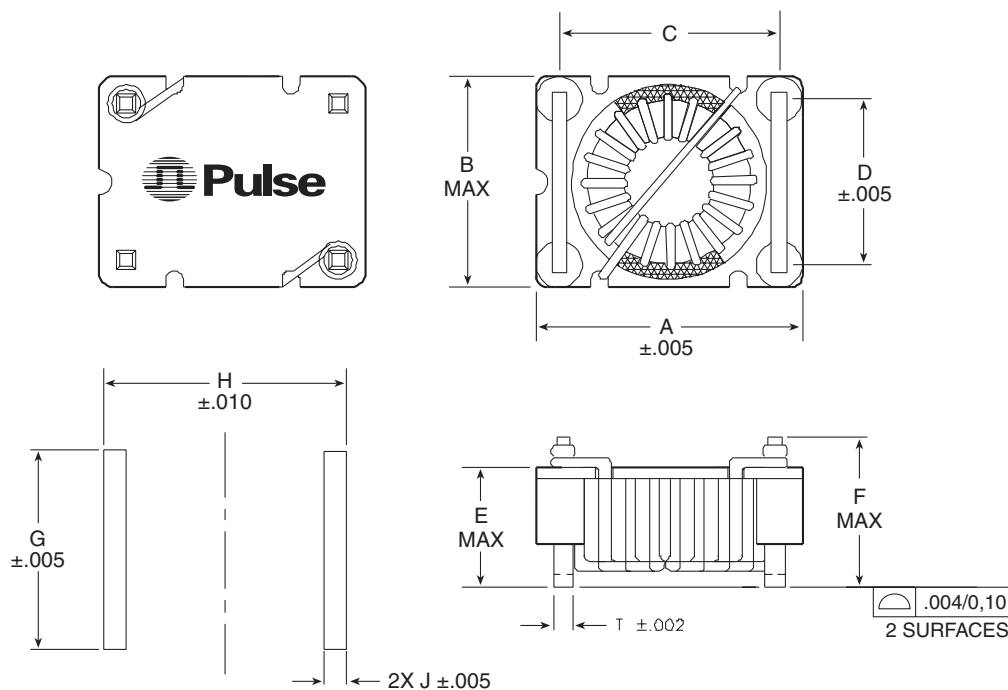

Dimensions: $\frac{\text{Inches}}{\text{mm}}$

SUGGESTED PAD LAYOUT

PKG	A	B	C	D	E	F	G	H	J	T	Weight (grams MAX)	Tube Pan (QTY)	Tape Pan (QTY)
SLED 20	$\frac{.400}{10,16}$	$\frac{.345}{8,76}$	$\frac{.300}{7,62}$	$\frac{.245}{6,22}$	$\frac{.200}{5,08}$	$\frac{.250}{6,35}$	$\frac{.310}{7,87}$	$\frac{.345}{8,76}$	$\frac{.045}{1,14}$	$\frac{.025}{0,64}$	0.66	30	800
SLED 30	$\frac{.625}{15,88}$	$\frac{.525}{13,34}$	$\frac{.500}{9,91}$	$\frac{.400}{10,16}$	$\frac{.325}{8,26}$	$\frac{.400}{10,16}$	$\frac{.460}{11,68}$	$\frac{.560}{14,22}$	$\frac{.045}{1,14}$	$\frac{.040}{1,02}$	2.53	35	200
SLED 40	$\frac{.725}{18,42}$	$\frac{.575}{14,61}$	$\frac{.600}{15,24}$	$\frac{.450}{11,43}$	$\frac{.335}{8,51}$	$\frac{.410}{10,41}$	$\frac{.540}{13,72}$	$\frac{.660}{16,76}$	$\frac{.060}{1,52}$	$\frac{.040}{1,02}$	4.62	30	200
SLED 50	$\frac{.900}{22,86}$	$\frac{.690}{17,53}$	$\frac{.730}{18,54}$	$\frac{.520}{13,21}$	$\frac{.415}{10,54}$	$\frac{.520}{13,21}$	$\frac{.640}{16,26}$	$\frac{.810}{20,57}$	$\frac{.080}{2,03}$	$\frac{.060}{1,52}$	9.02	30	150
SLED 60	$\frac{1,275}{32,39}$	$\frac{1,065}{27,05}$	$\frac{1,100}{27,94}$	$\frac{.890}{22,61}$	$\frac{.405}{10,29}$	$\frac{.510}{12,95}$	$\frac{.985}{25,02}$	$\frac{1,180}{29,97}$	$\frac{.080}{2,03}$	$\frac{.060}{1,52}$	15.00	15	100

For More Information:

UNITED STATES (Worldwide)

2 Pearl Buck Court
Bristol, PA 19007
U.S.A.
<http://www.pulseeng.com>
TEL: 215 781 6410
FAX: 215 781 6403

Pulse Northern Europe

3 Huxley Road
Surrey Research Park
Guildford, Surrey GU2 5RE
United Kingdom
TEL: 44 1483 401700
FAX: 44 1483 401701

Pulse Southern Europe

Zone Industrielle
F-39270
Orgelet
France
TEL: 33 3 84 35 04 04
FAX: 33 3 84 25 46 41

Pulse China Headquarters

No. 1
Industrial District
Changan, Dongguan
China
TEL: 86 769 85538070
FAX: 86 769 85538870

Pulse North China

Room 1503
XinYin Building
No. 888 YiShan Road
Shanghai 200233
China
TEL: 86 21 54643211/2
FAX: 86 21 54643210

Pulse South Asia

150 Kampong Ampat
#07-01/02
KA Centre
Singapore 368324
TEL: 65 6287 8998
FAX: 65 6280 0080

Pulse North Asia

No. 26
Kao Ching Road
Yang Mei Chen
Taoyuan Hsien
Taiwan, R. O. C.
TEL: 886 3 4641811
FAX: 886 3 4641911

Performance warranty of products offered on this data sheet is limited to the parameters specified. Data is subject to change without notice. Other brand and product names mentioned herein may be trademarks or registered trademarks of their respective owners. © Copyright, 2010. Pulse Engineering, Inc. All rights reserved.

X-ON Electronics

Largest Supplier of Electrical and Electronic Components

Click to view similar products for [Fixed Inductors](#) category:

Click to view products by [iNRCORE](#) manufacturer:

Other Similar products are found below :

[CR43NP-680KC](#) [CR54NP-820KC](#) [CR54NP-8R5MC](#) [CTX32CT-100](#) [70F224AI](#) [MGDQ4-00004-P](#) [MHL1ECTTP18NJ](#) [MHL1JCTTD12NJ](#)
[PE-51506NL](#) [PE-53601NL](#) [PE-53602NL](#) [PE-53630NL](#) [PE-53824SNLT](#) [PE-92100NL](#) [PG0434.801NLT](#) [PG0936.113NLT](#) [9310-16](#) [PM06-2N7](#) [PM06-39NJ](#) [A01TK](#) [1206CS-471XJ](#) [HC2-2R2TR](#) [HC2LP-R47-R](#) [HC3-2R2-R](#) [1206CS-151XG](#) [RCH664NP-140L](#) [RCH664NP-4R7M](#)
[RCH8011NP-221L](#) [RCP1317NP-332L](#) [RCP1317NP-391L](#) [RCR1010NP-470M](#) [RCR110DNP-331L](#) [DH2280-4R7M](#) [DS1608C-106](#) [ASPI-4020HI-R10M-T](#) [B10TJ](#) [B82477P4333M](#) [B82498B3101J000](#) [B82498B3680J000](#) [ELJ-RE27NJF2](#) [1812CS-153XJ](#) [1812CS-183XJ](#) [1812CS-223XJ](#) [1812LS-104XJ](#) [1812LS-105XJ](#) [1812LS-124XJ](#) [1812LS-154XJ](#) [1812LS-223XJ](#) [1812LS-224XJ](#) [1812LS-563XJ](#)