

ISP091201

Bluetooth Low Energy Module

with Integrated Antenna

This LGA module, 8 x 12 x 1.5 mm, is based on the nRF8001 μ Blue Chip. Combined with an external MCU, this module integrating an optimized antenna offers the perfect solution for Bluetooth connectivity. The solution is best in class for RF performance and low power consumption. SPI and UART interfaces are available for easy communication and give the opportunity to add BLE connectivity to any designs.

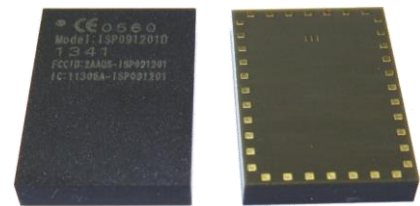

Key Features

- Single Mode BLE V4.0 Slave
- Based on Nordic Semiconductor nRF8001 μ Blue products
- 2.4GHz low energy RF Transceiver
- Includes Software stack
- Ultra Low Power Consumption
- Single 1.9 to 3.6 V supply
- Very small size 8.0 x 12.0 x 1.5 mm
- Temperature -40 to +85 °C
- Fully integrated RF matching and Antenna
- Integrated 16 MHz Crystal Oscillator
- Possibility to connect external 32.768 kHz crystal or reference
- Possibility to enable DC-DC converter by adding external passive components

Applications

- Connected sensors for medical devices, healthcare, sport, fitness, industrial ...
- IoT applications, connected objects
- Wearable technology
- Home automation
- Beacons

Certifications

- FCC limited modular certification
- Fully CE pre-certified module
- Fully IC pre-certified module
- Fully TELEC pre-certified module
- KCC limited modular certification
- Bluetooth SIG certified QDL listing
- RoHS compliant

Contents

1.	Block Diagram	3
2.	Specifications	4
2.1.	Absolute Maximum Ratings.....	4
2.2.	Operating Conditions.....	4
2.3.	Power Consumption	4
2.4.	Clock Sources	5
2.5.	Radio Specifications.....	5
2.6.	Electrical Schematic	7
3.	Pin Description	8
4.	Mechanical Outlines	10
4.1.	Mechanical Dimensions	10
4.2.	SMT Assembly Guidelines	11
4.3.	Antenna Keep-Out Zone	12
5.	Product Development Tools	13
5.1.	Interface.....	13
5.2.	Hardware	13
5.3.	Development Tools and Software	13
6.	Packaging & Ordering information.....	14
6.1.	Marking.....	14
6.2.	Prototype Packaging	14
6.3.	Jedec Trays	14
6.4.	Tape and Reel.....	15
6.5.	Ordering Information	16
7.	Storage & Soldering information	17
7.1.	Storage and Handling.....	17
7.2.	Moisture Sensitivity	17
7.3.	Soldering information	18
8.	Quality & User information.....	19
8.1.	Certifications.....	19
8.2.	USA - FCC Grant Conditions and User Information.....	19
8.3.	Canada – User Information	21
8.4.	Korea - KCC Grant Conditions and User Information	21
8.5.	Discontinuity	22
8.6.	Disclaimer.....	22

1. Block Diagram

This module is based on Nordic Semiconductor nRF8001 μ Blue Bluetooth Low Energy Platform. The nRF8001 is a single chip transceiver with an embedded baseband protocol engine, suitable for ultra-low power wireless applications conforming to the Bluetooth Low Energy Specification contained within v4.0 of the overall Bluetooth specification.

The nRF8001, used in the current revision of ISP091201, is a production product using a RoM for the baseband protocol engine. The μ Blue transceiver is specifically designed for both PC peripherals and ultra-low power applications such as sports and wellness sensors. For sensor applications, the ultra-low power consumption and advanced power management enables battery lifetimes up to several years on a coin cell battery.

The ISP091201 module size measures 8 x 12 x 1.5 mm. The module integrates all the decoupling capacitors, the 16 MHz crystal and load capacitors plus the RF matching circuit and antenna in addition to the transceiver.

As the module has several end applications, the antenna was designed to be compatible with several ground plane sizes including that of a USB dongle and a cell phone. The module can operate as a standalone Bluetooth sensor node with the addition of a transducer, a small external microprocessor to run application software, a 32 kHz crystal and a DC power source.

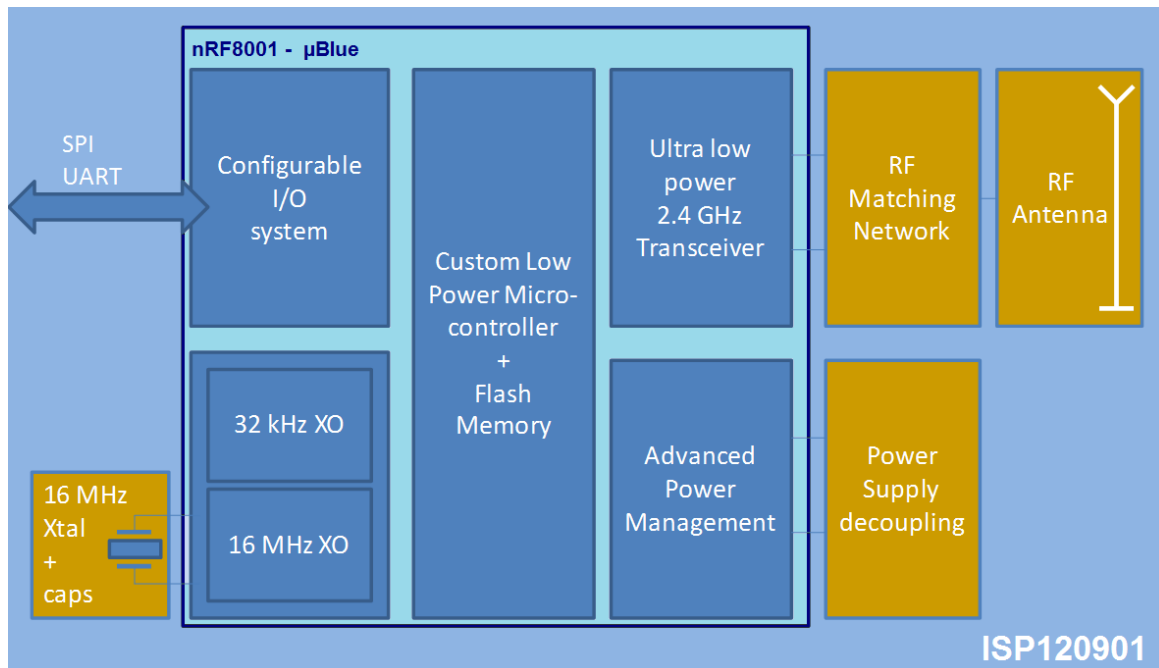

2. Specifications

The specifications of the module follow those of the nRF8001. The following high level parameters are given for the module.

2.1. Absolute Maximum Ratings

Parameter	Min	Typ	Max	Unit
Supply Voltage respect to ground - VCC	-0.3		3.6	V
IO Pin Voltage	-0.3		VCC + 0.3	V
Storage Temperature	-40		+125	°C
Moisture Sensitivity Level			5	-
ESD Human Body Model			2	Class

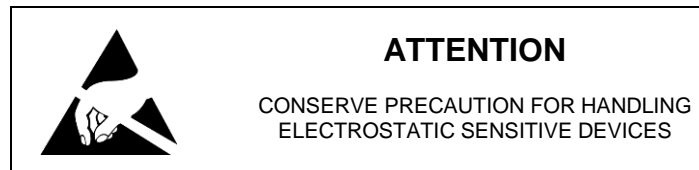

2.2. Operating Conditions

Parameter	Min	Typ	Max	Unit
Operating Supply Voltage	1.9	3.0	3.6	V
Operating Supply Voltage, DCDC converter setup	2.3	3.0	3.6	V
Extended Industrial Operating Temperature Range	-40	+25	+85	°C

2.3. Power Consumption

Parameter	Min	Typ	Max	Unit
Peak current, Receiver active		14.6		mA
Peak current, Transmitter active 0 dBm Output Power		12.7		mA
Current drain, Connection-less state, no RAM retention		0.5		µA
Current drain, Between connection events		2.0		µA

2.4. Clock Sources

Parameter	Min	Typ	Max	Unit
Internal High Frequency Clock for RF Stability: 16 MHz Crystal Frequency Tolerance ⁽¹⁾			+/- 40	ppm
RF Frequency tolerance: For BLE operation Channels 0 to 39			+/- 40	ppm

2.5. Radio Specifications

Parameter	Min	Typ	Max	Unit
Frequency Range	2402		2480	Mhz
Channel 0 to 39 Spacing		2		Mhz
Output Power Channels 0 to 39		-0.9		dBm
Rx sensitivity Level for BER <0,1% ideal Tx	-87			dBm
Antenna Gain		1.2		dBi
EIRP		0.3		dBm
Range Open field @1m height		70		m

✚ Typical Antenna Return Loss

Module mounted on a USB dongle ground plane

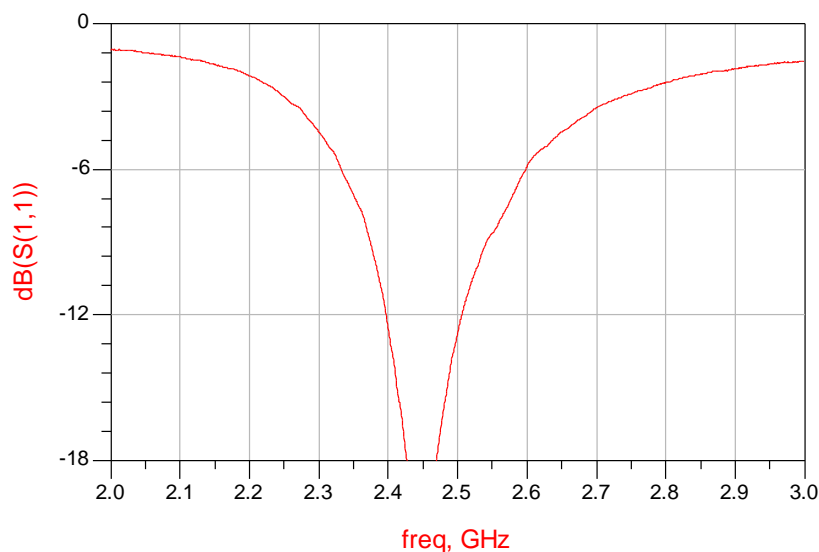

Radiation Pattern in 3 planes

Module mounted on a USB dongle ground plane
Gain measurement in dBi @ 2.45 GHz

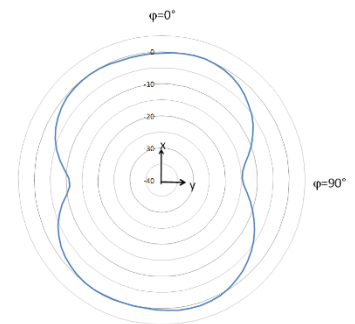
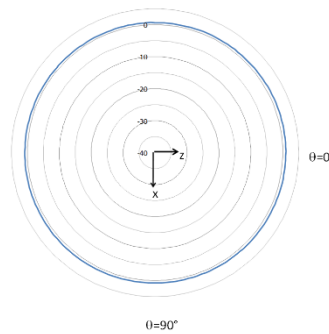
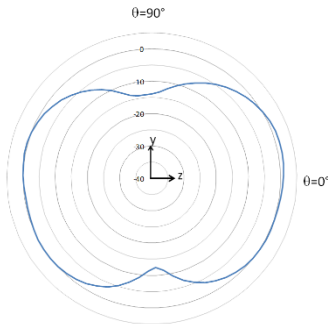
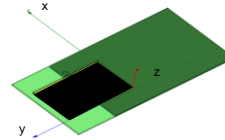

Ground Plane Effect Simulation

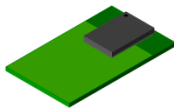

USB dongle
ground plane
(size : 18 x 30 mm²)

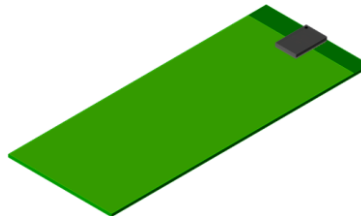

Cell phone config 1
ground plane
(size : 40 x 100 mm²)

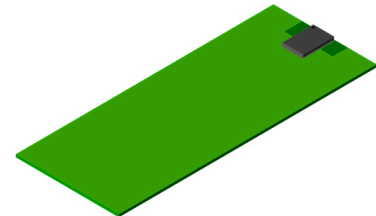

Cell phone config 1 with
side ground plane
(size : 40 x 100 mm²)

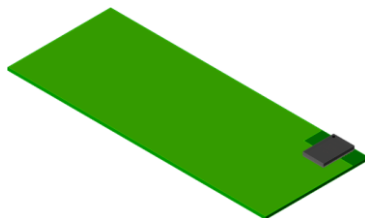

Cell phone config 2 with
side ground plane
(size : 40 x 100 mm²)

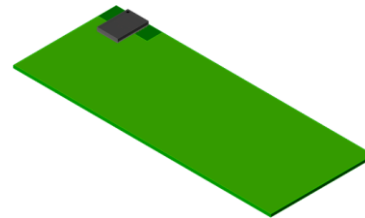

Cell phone config 3 with
side ground plane
(size : 40 x 100 mm²)

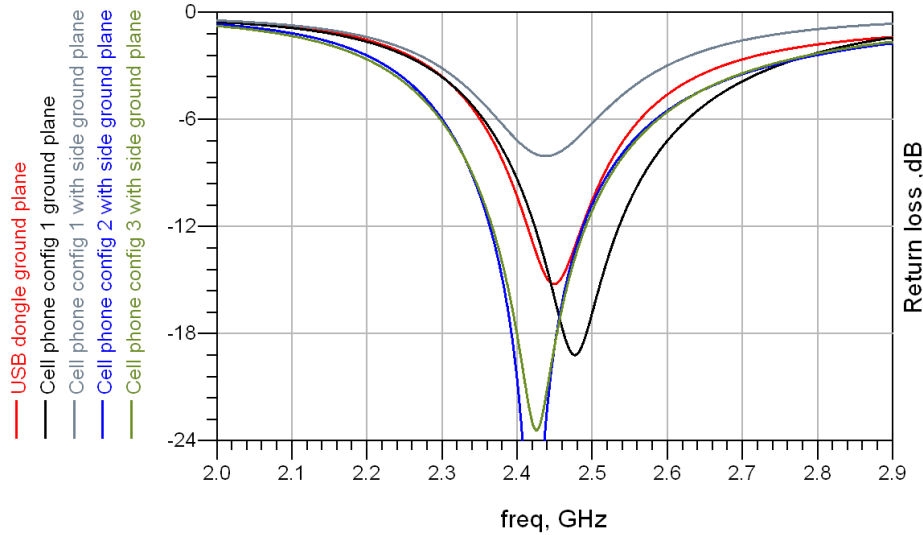

2.6. Electrical Schematic

Electrical schematic showing ISP091201 module connections

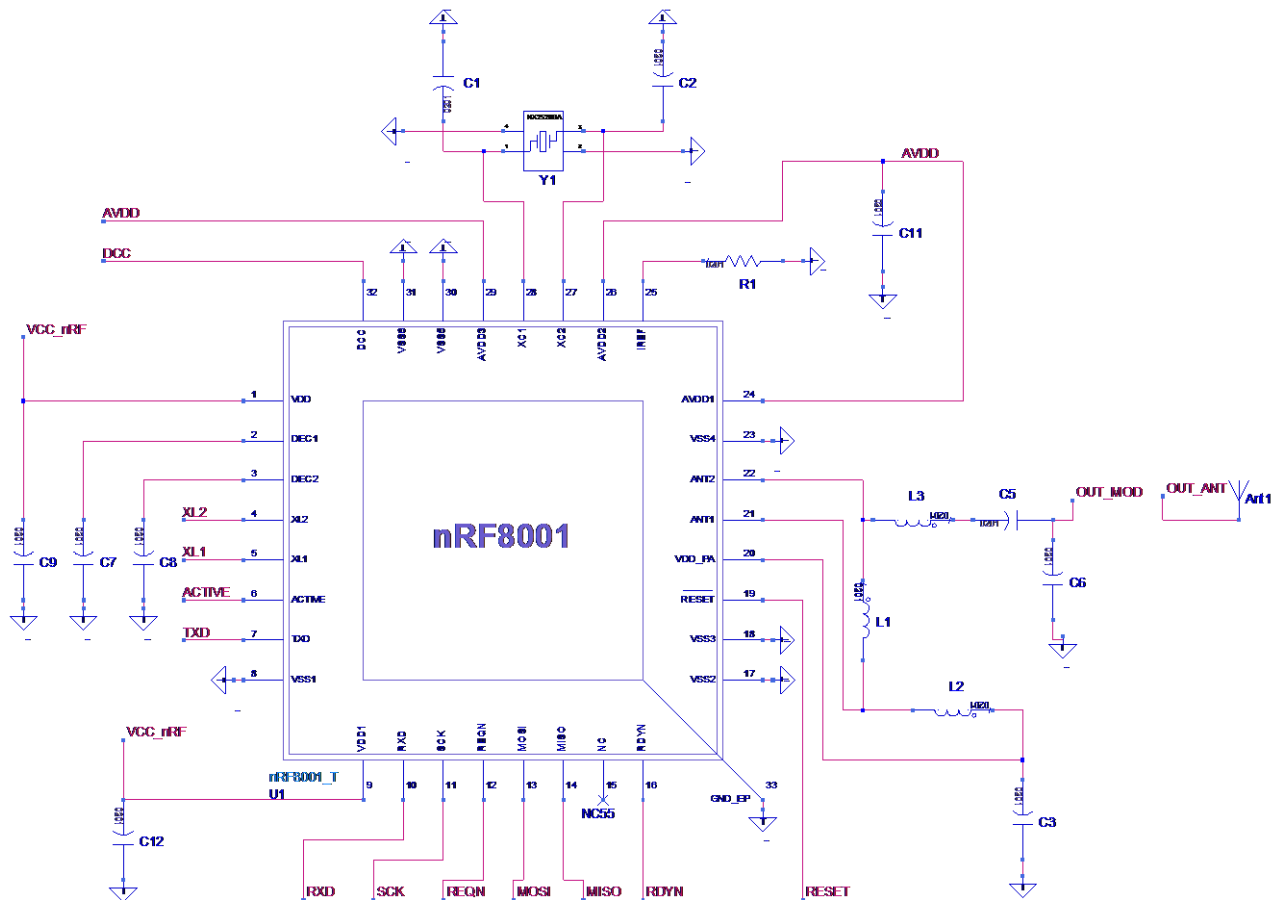

3. Pin Description

The module uses an LGA format with a single row of. The NC pads are to be connected to isolated metal pads on the application PCB for mechanical stability and reliability (drop test).

Pin	Name	Pin function	Description
1 – 5	NC	Not Connected	Isolated pad on application PCB for mechanical stability
6	OUT_ANT	Antenna In/Out	This pin is connected to the internal antenna. It should be connected to Pin 7 OUT_MOD for normal operation. During certification the pin may be connected to an RF connector for antenna measurement
7	OUT_MOD	Module In/Out	This pin is the RF I/O pin of the BLE module. It should be connected to Pin 6 OUT_ANT for normal operation. During certification the pin may be connected to an RF connector for module measurement using a Bluetooth test setup
8	GND	Ground	Should be connected to ground plane on application PCB
9	NC	Not Connected	Isolated pad on application PCB for mechanical stability
10	MOSI	Digital input	ACI Master Out Slave In
11	DCC	PWM driver	PWM driver for the external LC filter if the DC/DC converter is enabled. If the DC/DC converter is disabled this pin shall be not connected
12	AVDD	Power	Analog power supply (1.9 – 3.6V DC)
13	VCC_nRF	Power	Power supply (1.9 – 3.6V) Supplies the DC/DC converter and GPIOs. VDD in nRF8001 doc
14	GND	Ground	Should be connected to ground plane on application PCB
15	XL2	Analog output	Connect to external 32.768kHz crystal oscillator (if internal RC oscillator is enabled then leave not connected)
16	XL1	Analog output	Connect to external 32.768kHz crystal oscillator (if internal RC oscillator is enabled then leave not connected)
17	ACTIVE	Digital output	Device RF front end activity indicator
18	TXD	Digital output	UART (transmit) for Bluetooth low energy Direct Test Mode
19	SCK	Digital input	ACI clock input
20	RXD	Digital output	UART (receive) for Bluetooth low energy Direct Test Mode
21	REQN	Digital input	ACI request pin (handshaking, active low)
22	MISO	Digital output	ACI Master In Slave Out
23	GND	Ground	Should be connected to ground plane on application PCB
24	RDYN	Digital output	ACI device ready indication (handshaking)
25	RESET	Digital Input	Reset (Active Low)
26-36	NC	Not Connected	Isolated pad on PCB for mechanical stability

ISP091201 pin assignment

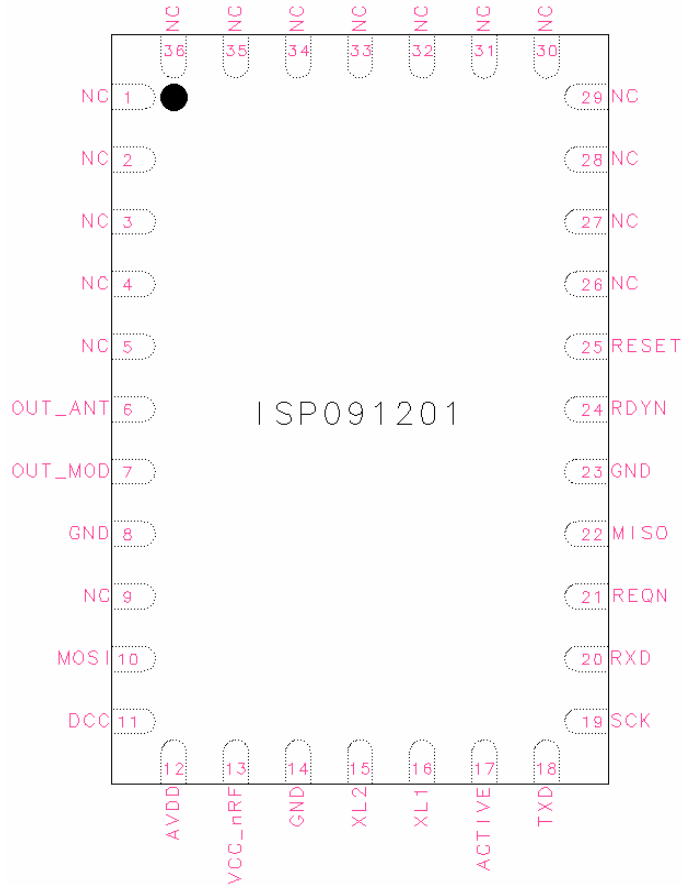

TOP VIEW

4. Mechanical Outlines

4.1. Mechanical Dimensions

Dimensional drawing for 8 x 12 x 1.5 mm, 36-Pad LGA Package

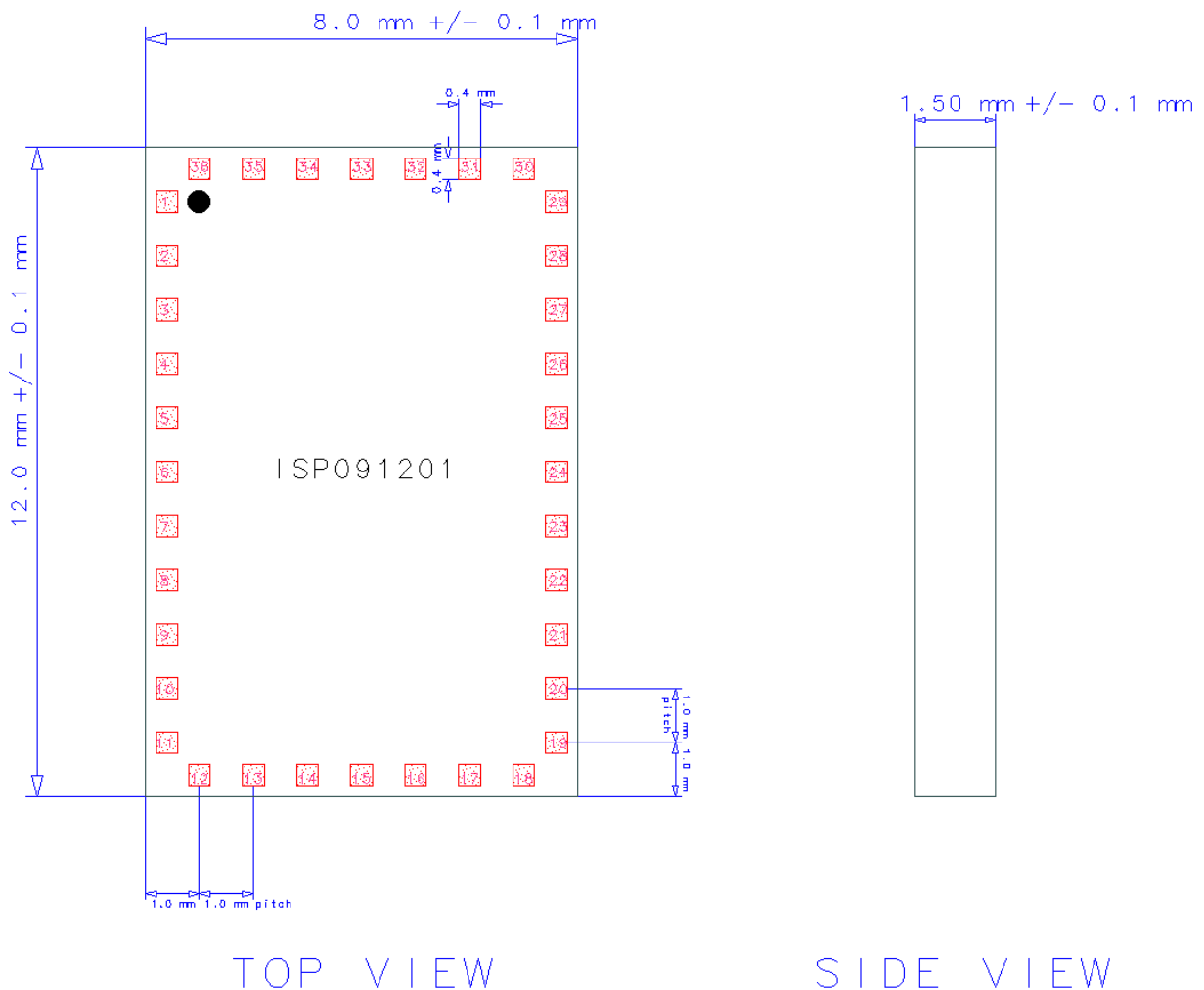

4.2. SMT Assembly Guidelines

Recommended PCB Land Pattern and Solder Mask layout.
Complete information is available on request.

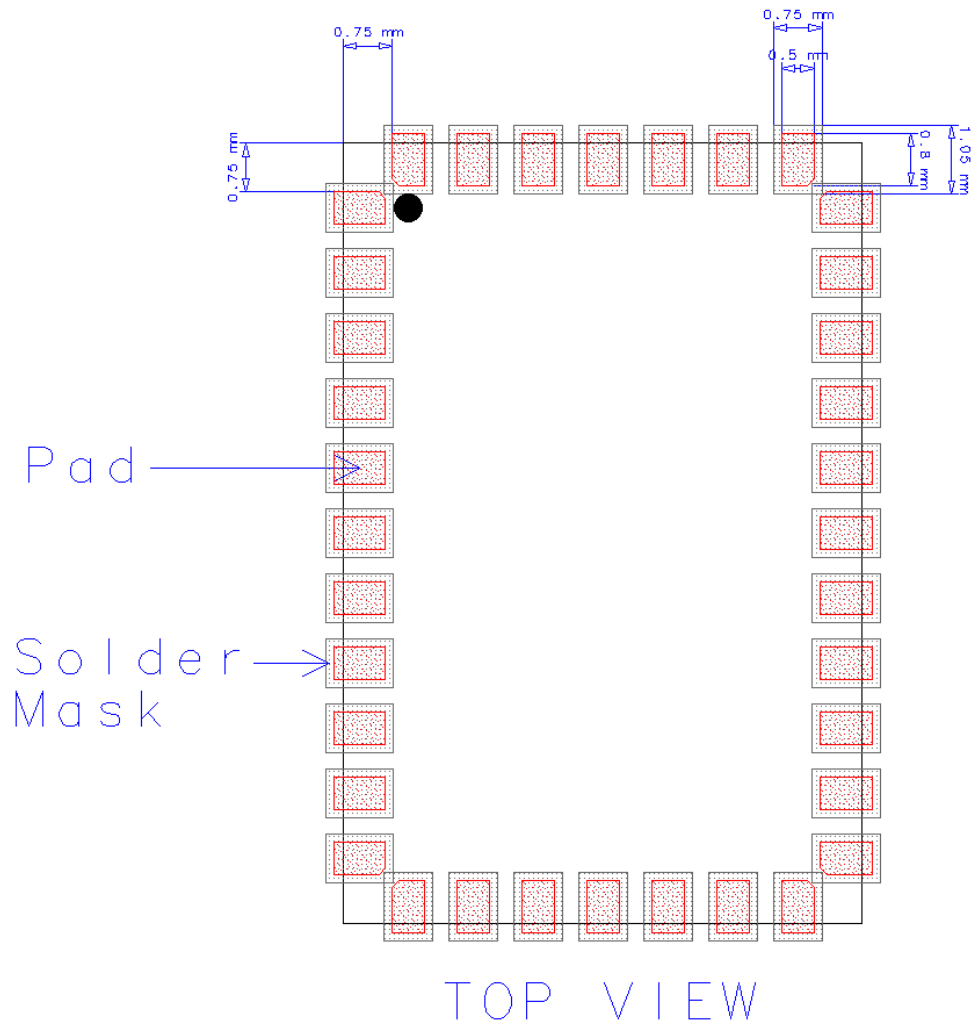

4.3. Antenna Keep-Out Zone

For optimal antenna performance, it is recommended to respect a metal exclusion zone to the edge of the board: no metal, no traces and no components on any application PCB layer except mechanical LGA pads.

Metal exclusion zone to edge of board (no metal on any layer except mechanical LGA pads)

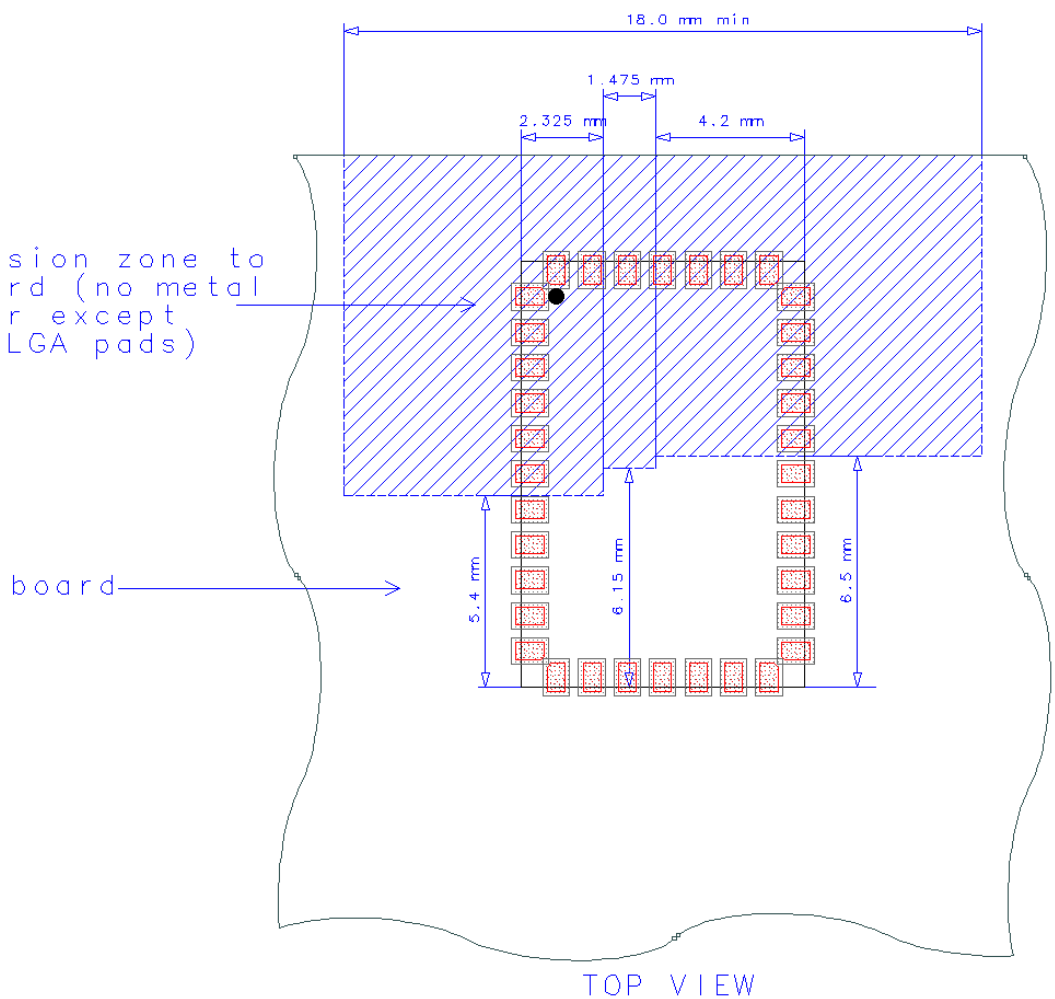

5. Product Development Tools

5.1. Interface

As ISP091201 is designed for operation in the peripheral role, it offers you an easy way to add Bluetooth low energy connectivity to your application. ISP091201 integrates a serial interface (ACI) for configuration and control from your microcontroller. In the following, the microcontroller is referred to as the application controller.

The Application Controller Interface (ACI) is the logical interface between ISP091201 and your application. ACI is a bidirectional serial interface that enables generic application controllers to set up and operate nRF8001 integrated in ISP091201.

5.2. Hardware

The following development kits are recommended for using and testing ISP091201 module:

- ✚ Nordic Semiconductor nRFgo Starter Kit (nRF6700), need to be purchased separately
- ✚ Nordic Semiconductor nRF80001 Development Kit (nRF8001-DK), need to be purchased separately
- ✚ Insight SiP Development Kit (ISP091201-DK), need to be purchased separately

Please refer to the documentation for more information:

http://www.insightsip.com/fichiers_insightsip/pdf/ble/ISP091201/isp_ble_DS091201_DK.pdf

http://www.insightsip.com/fichiers_insightsip/pdf/ble/ISP091201/isp_ble_AN120102.pdf

5.3. Development Tools and Software

The following development tools and software are recommended for using and testing ISP091201 module:

- ✚ ACI commands and events are defined in nRF8001 Data Sheet downloadable for free from www.nordicsemi.com.
- ✚ Nordic Semiconductor Software Development Kit for nRF8001 (nRF8001-SDK, downloadable from www.nordicsemi.com after purchasing nRF8001-DK): give access to software source code examples.
- ✚ Nordic Semiconductor nRFgo Studio (downloadable from www.nordicsemi.com after purchasing nRFgo Starter Kit nRF6700)
- ✚ Nordic Semiconductor Master Control Panel (downloadable from www.nordicsemi.com after purchasing nRF8001-DK)
- ✚ IDE compatible with your chosen microprocessor. As ISP091201 is designed for operation in the peripheral role, it offers you an easy way to add Bluetooth low energy connectivity to your application. ISP091201 integrates a serial interface (ACI) for configuration and control from your microcontroller. In the following, the microcontroller is referred to as the application controller.

6. Packaging & Ordering information

6.1. Marking

M	/N	:	I	S	P	0	9	1	2	0	1
T	T		Y	Y	W	W	R				

ISP091201	Part Number
TT	2 letters Module Type (see section 6.5)
YY	2 digits year number
WW	2 digits week number
R	1 letter Hardware revision

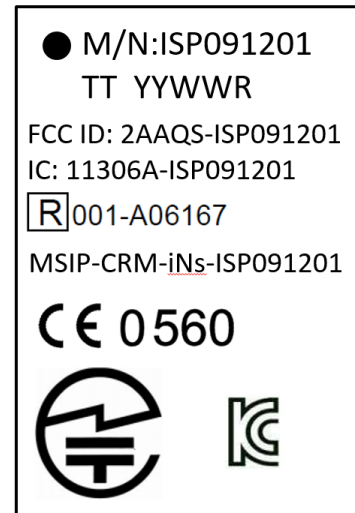

6.2. Prototype Packaging

For engineering samples and prototype quantities up to 99 units, deliveries are provided in thermoformed trays or cut tapes. Please order with “ST” code packaging suffix.

These parts must be baked prior to assembly (see section 7.2).



6.3. Jedec Trays

For higher quantities and volume production, ISP091201 are available in Jedec trays. They are delivered in sealed pack with desiccant pack and humidity sensors. These Jedec trays are also suitable for further baking. Please see section 7.2 for more information on moisture sensitivity. Please order with “JT” code packaging suffix.

Refer to tray sizes below. Complete information on Jedec trays is available on request.

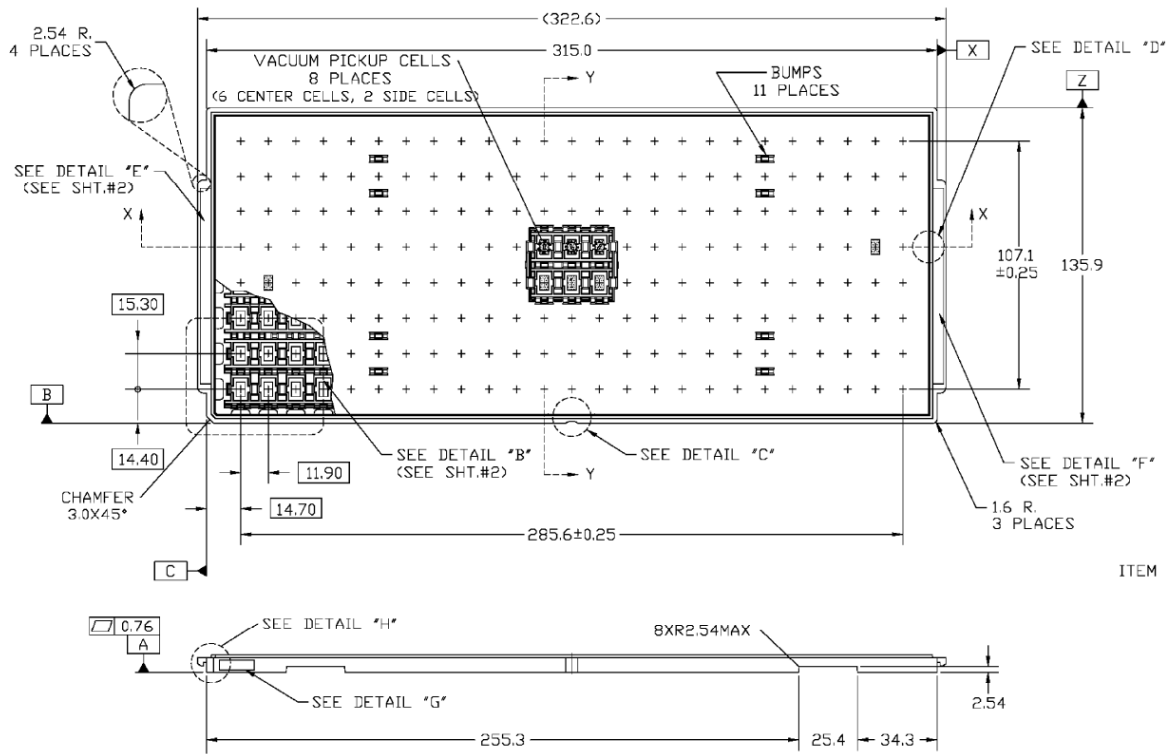

6.4. Tape and Reel

ISP091201 are also available in Tape & Reel. They are delivered in sealed pack with desiccant pack and humidity sensors. Reels are proposed in standard quantities of 500 units (180mm / 7" reel) or 2000 units (330mm / 13" reel) only. Please order with "RS" code packaging suffix for 500-unit reels and "R2" for 2000-unit reels.

Please refer to tape size below. Complete information is available on request.

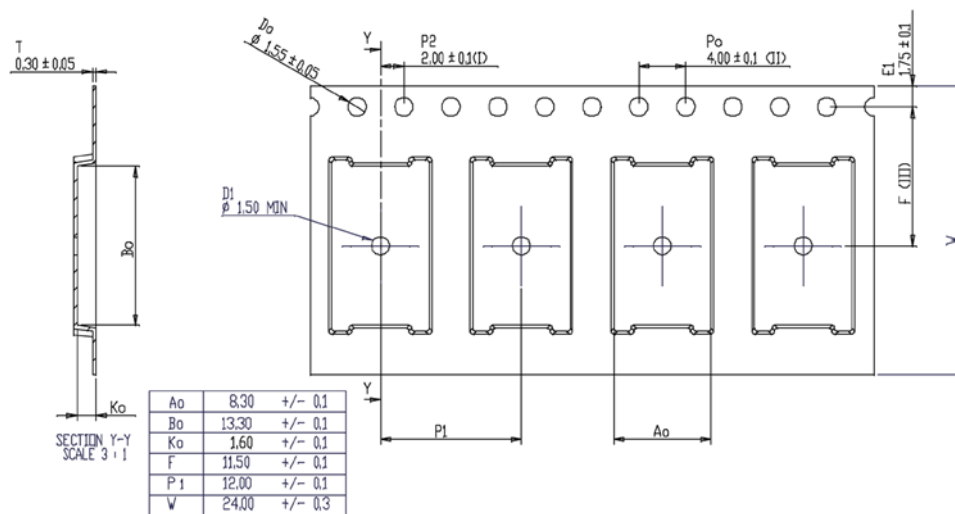

6.5. Ordering Information

I	S	P	0	9	1	2	0	1	-	T	T	-	Z	Z	
										▼	▼		▼	▼	
										▼	▼		▼	▼	
										▼	▼		▼	▼	
I	S	P	0	9	1	2	0	1							Part Number
									-	B					BLE protocol type
									-		N				No MCU
															Development kit ⁽¹⁾
															Test board ⁽¹⁾
															Unsealed Tray or Cut Tape
															Jedec Tray Packaging
															Reel of 500 units
															Reel of 2000 units

(1) Please see section 5.2 and refer to the following documentation for more information on development kit and test board:

http://www.insightsip.com/fichiers_insightsip/pdf/ble/ISP091201/isp_ble_DS091201_DK.pdf

http://www.insightsip.com/fichiers_insightsip/pdf/ble/ISP091201/isp_ble_AN120102.pdf

7. Storage & Soldering information

7.1. Storage and Handling

- ✚ Keep this product away from other high frequency devices which may interfere with operation such as other transmitters and devices generating high frequencies.
- ✚ Do not expose the module to the following conditions:
 - Corrosive gasses such as Cl₂, H₂S, NH₃, SO₂, or NO_x
 - Extreme humidity or salty air
 - Prolonged exposure to direct Sunlight
 - Temperatures beyond those specified for storage
- ✚ Do not apply mechanical stress
- ✚ Do not drop or shock the module
- ✚ Avoid static electricity, ESD and high voltage as these may damage the module

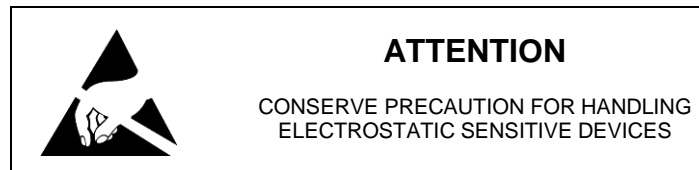

7.2. Moisture Sensitivity

All plastic packages absorb moisture. During typical solder reflow operations when SMDs are mounted onto a PCB, the entire PCB and device population are exposed to a rapid change in ambient temperature. Any absorbed moisture is quickly turned into superheated steam. This sudden change in vapor pressure can cause the package to swell. If the pressure exerted exceeds the flexural strength of the plastic mold compound, then it is possible to crack the package. Even if the package does not crack, interfacial delamination can occur.

Since the device package is sensitive to moisture absorption, it is recommended to bake the product before assembly. The baking process for dry packing is 24 hours at 125°C.

ISP091201 has been tested MSL-5 according to standards. After baking, modules can be exposed to ambient room conditions (approximately 30 °C/60%RH) during 48 hours before assembly on the PCB.



7.3. Soldering information

Recommendation for RoHS reflow process is according to Jedec J-STD-020 and 033 standard profiles.

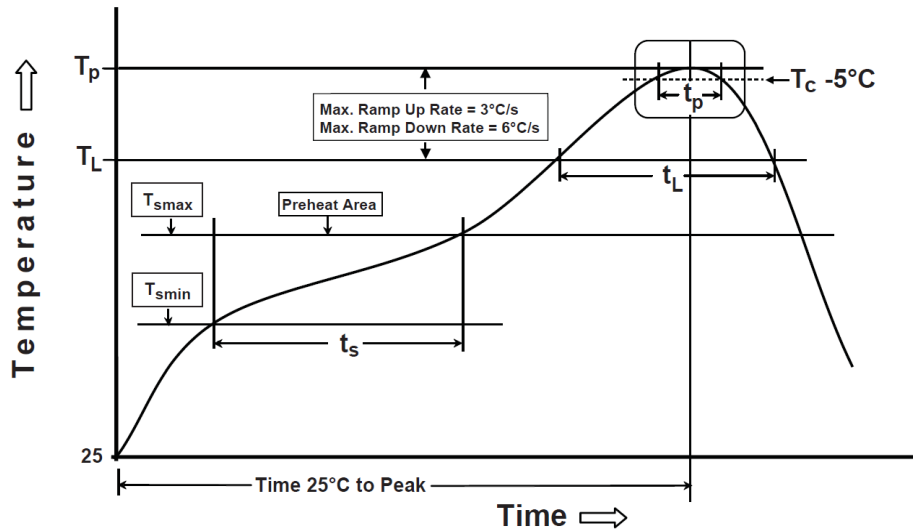

Preheat/Soak	
Temperature Min (T_{smin})	150 °C
Temperature Max (T_{smax})	200 °C
Time (t_s) from (T_{smin} to T_{smax})	60-120 sec
Ramp-up rate (T_L to T_p)	3 °C/sec max
Liquidous temperature (T_L)	217 °C
Time (t_L) maintained above T_L	60-150 sec

Peak package body temperature (T_p)	260°C (+0/-5°C)
Classification Temperature (T_C)	260 °C
Time (t_p) maintained above $T_C - 5^\circ C$	30 sec
Ramp-down rate (T_p to T_L)	6 °C/sec max
Time 25 °C to peak temperature	8 mn max

8. Quality & User information

8.1. Certifications

- ✚ FCC Limited Modular Certification 15.212 FCC #2AAQS-ISP091201
- ✚ CE: Complies with Directive 1999/5/EC statement N° 13214144/AA/00
- ✚ Canada: IC # 11306A-ISP091201
- ✚ TELEC certification N° 001 – A06167
- ✚ KCC Limited Modular Certification MSIP-CRM-iNs-ISP091201
- ✚ Bluetooth SIG certified #B017595
- ✚ RoHS compliant

8.2. USA - FCC Grant Conditions and User Information

ISP091201 is certified under FCC part 15.212 with “Limited Modular Approval”.

This approval is limited to hosts that use an additional metal shield, since certification has been carried out in this way. This ensures that the radio portion of the circuit is fully shielded on all sides with the exception of the antenna access. The module itself contains the lower ground plane so it is not necessary to have a continuous plane under the module in the host.

✚ Shielding

In order to respect FCC regulation, an additional metal shield must be implemented following the recommendation below. Note that shield installation is only related to FCC compliance. It has absolutely no influence on the module performance and the ISP091201 can operate according to the present specification with or without the shield.

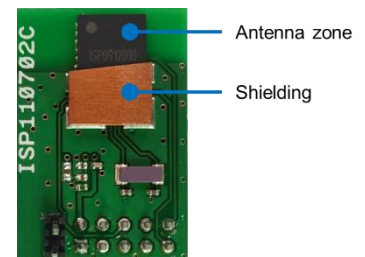

Shield installation land pattern:

Parameter	Description	Value in μm
a	Shield SM aperture	750
b	Shield metal trace width	500
	SM registration (a-b)/2	125
g	Module pad edge to shield trace edge	500
c		2000
d1		2300
d2		3400
e1		4525
e2		3525
f		2250

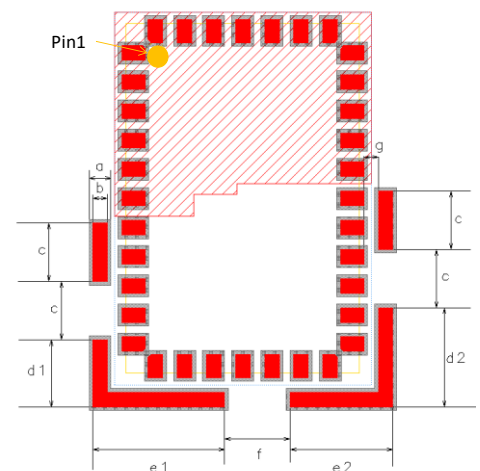

Mechanical drawing of the shield

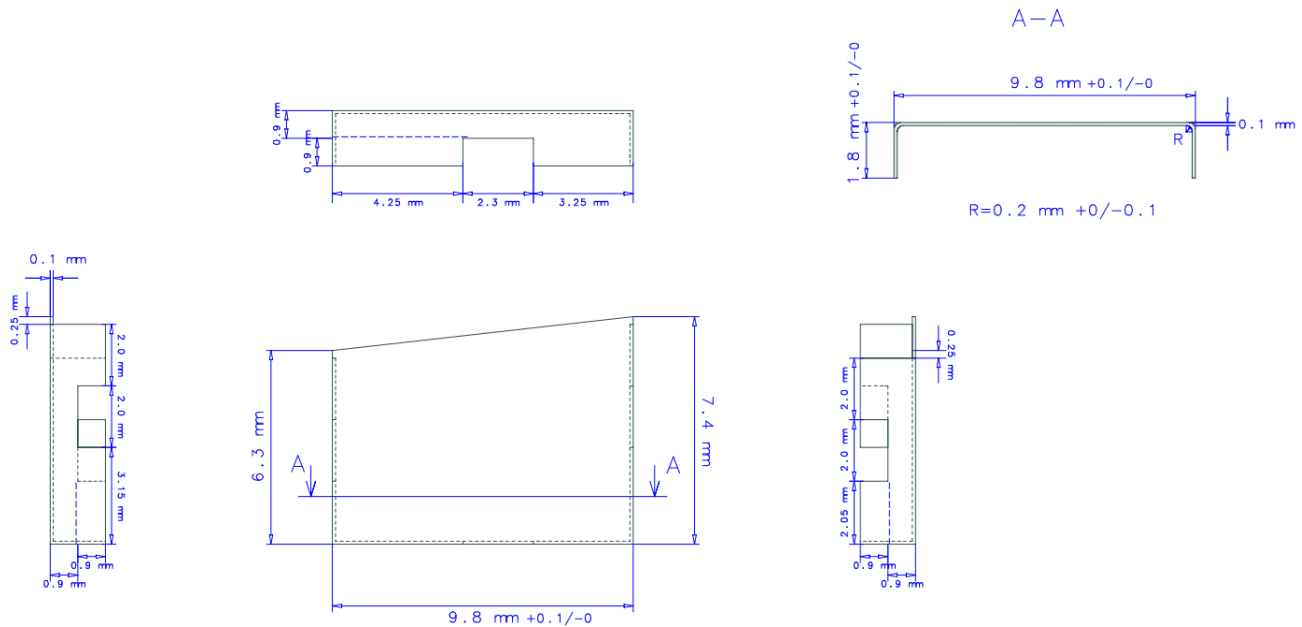

Marking

The ISP091201 is labeled with its own FCC identification number: FCC ID: 2AAQS-ISP091201.

Based on the Public Notice from FCC and as specified by the CFR47 part15.212 (a – VI), the host device should have a label which indicates that it contains our module. The label should use wording such as:

“Contains FCC ID: 2AAQS-ISP091201”.

Any similar wording that expresses the same meaning may be used.

The label of the host device should also include the below FCC Statement. When it is not possible, this information should be included in the User Manual of the host device:

*“This device complies with part 15 of the FCC rules. Operation is subject to the following two conditions.
(1) This device may not cause harmful interference
(2) This device must accept any interference received, including interference that may cause undesired operation.
Caution: Any Changes or modifications not expressly approved by the party responsible for compliance could void the user’s authority to operate the equipment.”*

8.3. Canada – User Information

This intends to inform how to specify the IC ID of our module “ISP091201” on the product. According to Canadian standards “RSS-210” and “RSS-Gen”, the host device should have a label which indicates that it contains our module. The label should use wording such as:

“Contains IC: 11306A-ISP091201”.

Any similar wording that expresses the same meaning may be used.

The label of the host device should also include the below IC Statement. When it is not possible, this information should be included in the User Manual of the host device:

“This device complies with Industry Canada licence-exempt RSS standard(s). Operation is subject to the following two conditions: (1) this device may not cause interference, and (2) this device must accept any interference, including interference that may cause undesired operation of the device.”

Le présent appareil est conforme aux CNR d'Industrie Canada applicables aux appareils radio exempts de licence. L'exploitation est autorisée aux deux conditions suivantes : (1) l'appareil ne doit pas produire de brouillage, et (2) l'utilisateur de l'appareil doit accepter tout brouillage radioélectrique subi, même si le brouillage est susceptible d'en compromettre le fonctionnement.”

8.4. Korea - KCC Grant Conditions and User Information

ISP091201 is certified under KCC with “Limited Modular Approval”. This approval is limited to hosts that use an additional metal shield, since certification has been carried out in this way. This ensures that the radio portion of the circuit is fully shielded on all sides with the exception of the antenna access. The module itself contains the lower ground plane so it is not necessary to have a continuous plane under the module in the host.

Shielding

For KCC certification, a shield must be installed as described in section 8.2.

Marking

The ISP091201 is labeled with its own KCC identification number:

KCC ID: MSIP-CRM-iNs-ISP091201. In addition, the shield must be marked with KCC logo and KCC ID: MSIP-CRM-iNs-ISP091201. Refer to above picture.



In order to comply with KCC, the host device should have a label which indicates that it contains our module. The label should use wording such as:

“Contains KCC ID: MSIP-CRM-iNs-ISP091201”.

The User Manual of the host device should also include the below KCC Statement:

이 기기는 업무용(A급) 전자파적합기기로서 판매자 또는 사용자는 이 점을 주의하시기 바라며,
가정 외의 지역에서 사용하는 것을 목적으로 합니다.
이 기기는 가정용(B급) 전자파적합기기로서 주로 가정에서 사용하는 것을 목적으로 하며,
모든 지역에서 사용할 수 있습니다.

8.5. Discontinuity

Normally a product will continue to be manufactured as long as all of the following are true:

- The manufacturing method is still available.
- There are no replacement products.
- There is demand for it in the market.

In case of obsolescence, Insight SiP will follow Jedec Standard JSD-48. A Product Discontinuation Notice (PDN) will be sent to all distributors and made available on our website. After this, the procedure goes as follows:

- Last Order Date will be 6 months after the PDN was published.
- Last Shipment Date will be 6 months after Last Order Date, i.e. 12 months after PDN.

8.6. Disclaimer

Insight SiP's products are designed and manufactured for general consumer applications, so testing and use of the product shall be conducted at customer's own risk and responsibility. Please conduct validation and verification and sufficient reliability evaluation of the products in actual condition of mounting and operating environment before commercial shipment of the equipment. Please also pay attention (i) to apply soldering method that don't deteriorate reliability, (ii) to minimize any mechanical vibration, shock, exposure to any static electricity, (iii) not to overstress the product during and after the soldering process.

The products are not designed for use in any application which requires especially high reliability where malfunction of these products can reasonably be expected to result in personal injury or damage to the third party's life, body or property, including and not limited to (i) aircraft equipment, (ii) aerospace equipment, (iii) undersea equipment, (iv) power plant control equipment, (v) medical equipment, (vi) transportation equipment, (vii) traffic signal equipment, (viii) disaster prevention / crime prevention equipment.

The only warranty that Insight SiP provides regarding the products is its conformance to specifications provided in datasheets. Insight SiP hereby disclaims all other warranties regarding the products, express or implied, including without limitation any warranty of fitness for a particular purpose, that they are defect-free, or against infringement of intellectual property rights. Insight SiP customers agree to indemnify and defend Insight SiP against all claims, damages, costs and expenses that may be incurred, including without any limitation, attorney fees and costs, due to the use of products.

X-ON Electronics

Largest Supplier of Electrical and Electronic Components

Click to view similar products for [Bluetooth Modules \(802.15.1\) category:](#)

Click to view products by [Insight SiP manufacturer:](#)

Other Similar products are found below :

[A2541R24A10GM](#) [BCM20737S](#) [BM64SPKA1MC1-0001AA](#) [CYW20732S](#) [968EMB0019](#) [WT32I-A-AI61C](#) [NRF51822-QFAA-R7-G0](#)
[BT680F](#) [BM83SM1-00AA](#) [DAT12](#) [BGM11S12F256GA-BG2](#) [BGM111A256V21R](#) [BGM210LA22JNF2](#) [MGM210LA22JNF2](#) [CYBT-](#)
[333047-02](#) [CYBT-333032-02](#) [RN4020-V/RMBEC133](#) [RN41-I/RM630](#) [1327](#) [RN42HID-I/RM](#) [RN4678-V/RM100](#) [ENW-89829C3KF](#)
[BLE113-A-V1](#) [BLE112-A-V1](#) [451-00001](#) [RN42HID-IRM](#) [RN41HCI-IRM](#) [BL600-SA-32](#) [EYSHCNZWZ](#) [EYSHJNZWZ](#) [BT820-02](#)
[CYBLE-212006-01](#) [ENW89837AUKF](#) [ENW89837AWKF](#) [ENW-89847A3KF](#) [RN4871-I/RM128](#) [451-00002](#) [BM23SPKA1NB9-0B02AA](#)
[BM71BLES1FC2-0B02AA](#) [450-0119R](#) [BT830-SA-01](#) [CYW20737S](#) [BT830-ST-01](#) [CYBLE-212020-01](#) [EYSGJNAWY-WX](#) [RN4870-](#)
[I/RM130](#) [CYBLE-224116-01](#) [CYBLE-202007-01](#) [BM63SPKA1MGA-0001AC](#) [BM70BLES1FC2-0B03AA](#)