

ISP2053

Dual-core Bluetooth 5.2 BLE Module with Mesh, NFC, Thread and Zigbee

This ultra-small LGA module, 8 x 8 x 1 mm, is based on the nRF5340 Chip. Its powerful Dual-core Cortex™ M33 CPUs, flash and RAM memory combined with an optimized antenna offers the perfect solution for High-end Bluetooth connectivity. Long range, high temperature and multiple digital and analog interfaces give optimum flexibility for sensor integration, audio and complex IoT processing.

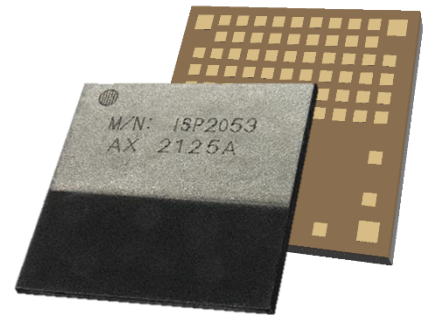

Key Features

- Bluetooth Low Energy 5.2
LE Audio, Direction Finding and Long Range
- BT Mesh, Thread, Zigbee, 802.15.4, ANT
- NFC
- Fully integrated RF Matching and Antenna
- Integrated 32 MHz & 32 kHz Clocks
- DC/DC converter with loading circuit
- Based on Nordic Semiconductor nRF53
- Application Processor ARM Cortex M33
1 MB Flash + 512 KB RAM and 8 KB Cache
- Network Processor ARM Cortex M33
256 KB Flash + 64 KB RAM and 2 KB Cache
- Security ARM TrustZone & CryptoCell 312
- Configurable 46 GPIOs including 8 ADCs
- Digital interfaces
USB, QSPI, SPI, UART, I²S, PDM, PWM
- Power supply 1.7 to 5.5V
- Very small size 8.0 x 8.0 x 1.0 mm
- Extended Temperature -40 to +105 °C

Applications

- LE Audio
- Professional lighting
- Industrial
- Advanced wearables
- Medical
- Smart home
- Asset tracking and RTLS



Pending Certifications

- Bluetooth SIG
- CE
- FCC, IC
- TELEC, KCC
- RoHS and Reach compliant
- Conflict Mineral Declaration

Revision History

Revision	Date	Ref	Change Description
R0	11/02/2021	jf pg	Preliminary release
R1	31/05/2021	jf pg	Change pinout
R2	24/09/2021	jf pg	Minor typo error correction
R3	03/11/2021	jf pg	Document review

Contents

1. Block Diagram	4
2. Specifications	6
2.1. Important Notice	6
2.2. Absolute Maximum Ratings.....	6
2.3. Operating Conditions.....	6
2.4. Power Consumption	7
2.5. Clock Sources	7
2.6. Radio Specifications.....	8
2.7. Range Measurement.....	8
2.8. Antenna Performance	8
2.9. Electrical Schematic	11
3. Pin Description	12
4. Mechanical Outlines.....	15
4.1. Mechanical Dimensions	15
4.2. SMT Assembly Guidelines	17
4.3. Antenna Performance	17
5. Product Development Tools	18
5.1. Hardware.....	18
5.2. Firmware	18
5.3. Development Tools	19
6. Packaging & Ordering information	20
6.1. Marking	20
6.2. Prototype Packaging	20
6.3. Jedec Trays.....	20
6.4. Tape and Reel.....	21
6.5. Ordering Information	22
7. Storage & Soldering information	23
7.1. Storage and Handling.....	23
7.2. Moisture Sensitivity	23
7.3. Soldering information	24
8. Quality & User information.....	25
8.1. Certifications.....	25
8.2. EC – CE Certification	25
8.3. USA – User information.....	25
8.4. Canada – User information	26
8.5. RF Exposure Information	26
8.6. Informations concernant l'exposition aux fréquences radio (RF)	26
8.7. Discontinuity.....	26
8.8. Disclaimer.....	27

1. Block Diagram

Based on nRF5340 Nordic Semiconductor wireless SoC with two Arm® Cortex®-M33 processors and advanced feature set, the ISP2053 module is ideally suited for LE Audio, professional lighting, advanced wearables, industrial, medical, and other complex IoT applications.

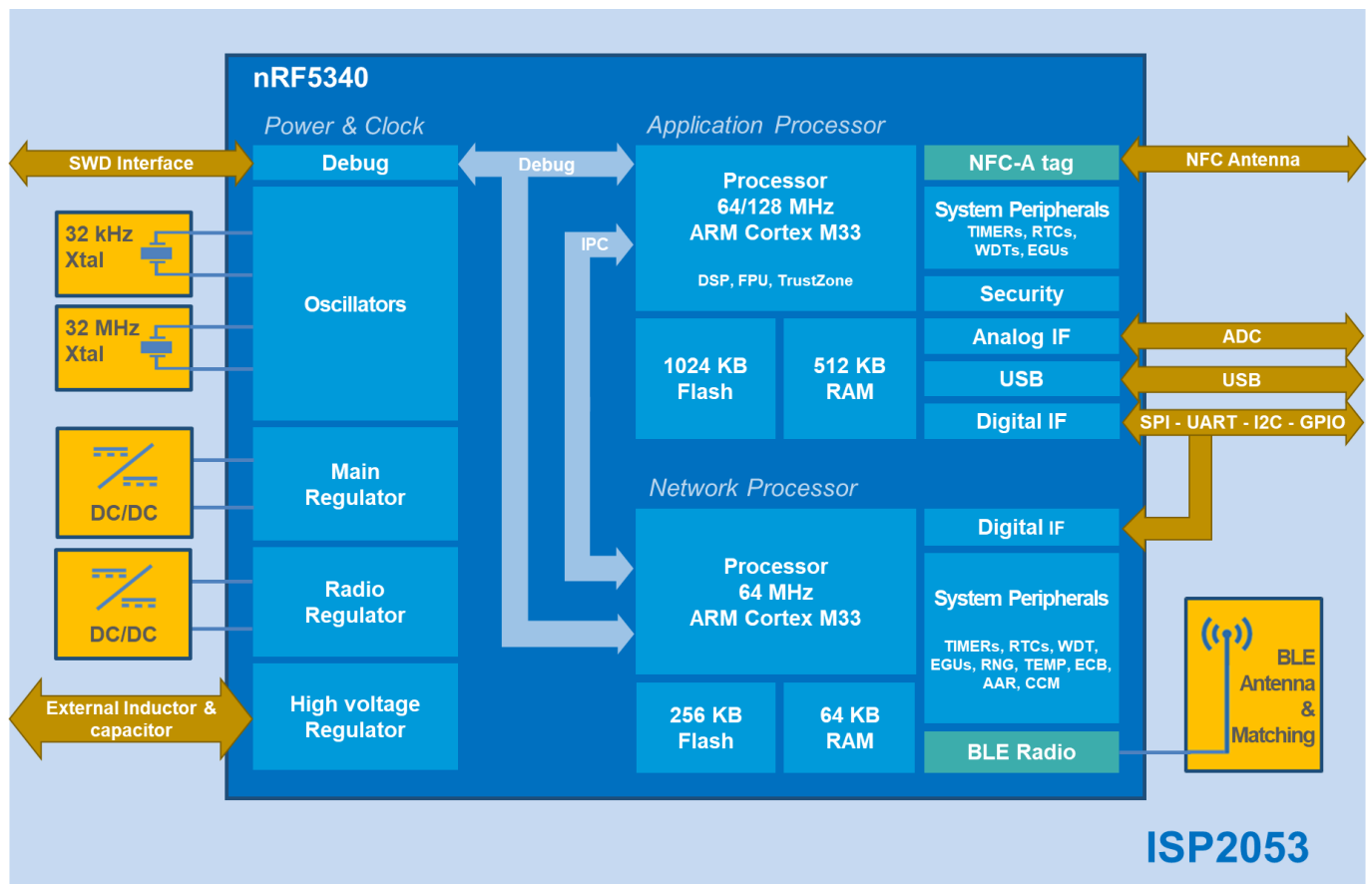

The application processor has 1 MB Flash, 512 KB RAM, a floating-point unit (FPU), an 8 KB 2-way associative cache and DSP instruction capabilities. The network processor is optimized for low power and offers 256 KB Flash and 64 KB RAM. In term of security, the Arm TrustZone provides trusted execution, the Arm CryptoCell-312 provides hardware-accelerated cryptography together with a root-of-trust and secure key storage management.

Ultra-low power consumption and advanced power management enables battery lifetimes up to several years on a coin cell battery. Despite its exceedingly small size 8 x 8 x 1 mm, the module integrates decoupling capacitors, 32 MHz and 32.768 kHz crystals, load capacitors, DC-DC converters, RF matching circuit and antenna in addition to the wireless SoC. Combined with numerous Digital and Analog IOs, System Peripherals, high-speed SPI, QSPI, USB, up to 105 °C operating temperature, the ISP2053 is the most advanced fully certified 2.4 GHz low energy module available on the market.

The ISP2053 supports a large choice of wireless protocols:

- Bluetooth Low Energy Central, Peripheral, Observer and Broadcaster roles.
- Angle-of-arrival (AoA) and angle-of-departure (AoD) roles.
- LE Audio, high-throughput 2 Mbps, Advertising Extensions and Long Range.
- Mesh protocols like Bluetooth mesh, Thread and Zigbee that can be run concurrently with Bluetooth LE.
- NFC, ANT, 802.15.4 and 2.4 GHz proprietary protocols.

The ISP2053 software platform is fully compatible with the Nordic Semiconductor nRF Connect SDK, which is offering a complete solution that integrates the Zephyr RTOS, protocol stacks, application samples and hardware drivers.

The ISP2053 development kit provides a complete hardware solution for prototyping, testing and programming with the maximum flexibility.

2. Specifications

2.1. Important Notice

The electrical specifications of the module are directly related to the Nordic Semiconductor specifications for the nRF5340 chipset. Bellow information is only a summary of the main parameters. For more detailed information, especially about current consumption, please refer to the up-to-date specification of the chipset available on Nordic Semi website.

2.2. Absolute Maximum Ratings

Parameter	Min	Typ	Max	Unit
Main Supply Voltage respect to ground – VDD_nRF	-0.3		3.9	V
High mode Supply Voltage respect to ground – VDDH_nRF	-0.3		5.8	V
USB Supply Voltage respect to ground – VBUS	-0.3		5.8	V
IO Pin Voltage	-0.3		3.9	V
RF Input Level			10	dBm
NFC Antenna pin current			80	mA
Storage Temperature	-40		+125	°C
Moisture Sensitivity Level			3	-
ESD Human Body Model			2000	V
ESD Charged Device Model			500	V
Flash Endurance			10000	cycles

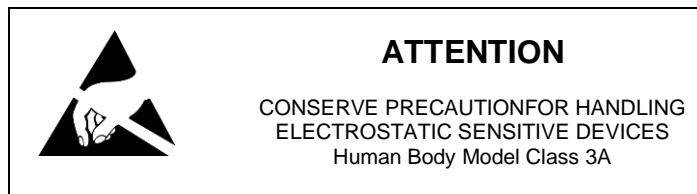

2.3. Operating Conditions

Parameter	Min	Typ	Max	Unit
VDD_nRF Supply Voltage, independent of DCDC enable	1.7	3.0	3.6	V
VDDH_nRF Supply Voltage, independent of DCDC enable	2.5	3.7	5.5	V
VBUS Supply Voltage	4.35	5.0	5.5	V
Extended Industrial Operating Temperature Range	-40	+25	+105	°C

2.4. Power Consumption

Unless specified VDD=VDDH=3V (normal mode), DCDCs enabled

Parameter	Min	Typ	Max	Unit
Peak Current, Transmitter +3 dBm		5.3		mA
Peak Current, Transmitter 0 dBm		4.1		mA
Peak Current, Receiver 1 Mbps		3.7		mA
Sleep current, System OFF, wake on reset		2.4		μA
Sleep current, System OFF, no application RAM, wake on reset		1.0		μA
Sleep current, System OFF, no application RAM, wake on reset, VDDH=5V		1.1		μA
Sleep current, System ON, wake on any event		1.3		μA
Sleep current, System ON, wake on RTC		1.5		μA
Application CPU current, 64MHz		3.6		mA
Application CPU current, 128MHz		8		mA
Network CPU current		2.4		mA

2.5. Clock Sources

Parameter	Min	Typ	Max	Unit
Internal High Frequency Clock for RF Stability: 32 MHz Crystal Frequency Tolerance ⁽¹⁾			+/- 40	ppm
Internal Low Frequency Clock for BLE Synchronization: 32.768 kHz Crystal Frequency Tolerance ⁽²⁾			+/- 40	ppm
Internal Low Frequency Clock for BLE Synchronization: RC Oscillator ⁽³⁾			+/- 250	ppm
RF Frequency Tolerance for BLE Operation			+/- 40	ppm

(1) including initial tolerance, drift, aging, and frequency pulling and temperature

(2) including initial tolerance, drift, aging, and frequency pulling

(3) Frequency tolerance after calibration

2.6. Radio Specifications

Parameter	Min	Typ	Max	Unit
Frequency Range	2360		2500	Mhz
Maximum Output Power			+3	dBm
Rx Sensitivity Level, BLE1 Mbps		-95		dBm
Rx Sensitivity Level, BLE Long Range 125 kbps		-104		dBm
Antenna Gain		0.6		dBi
EIRP	-19.4		8.6	dBm
Data Rate	125		2000	kbps

2.7. Range Measurement

Range measurement between ISP2053-AX test board (configured as Central) and ISP2053-AX test board (configured as Peripheral).

Parameter	Min	Typ	Max	Unit
Range Open field @1m height (0 dBm, 1 Mbps)		150		m
Range Open field @1m height (0 dBm, 125 Kbps)		175		m
Range Open field @1m height (8 dBm, 1 Mbps)		230		m
Range Open field @1m height (8 dBm, 125 Kbps)		450		m

2.8. Antenna Performance

Typical Antenna Return Loss

Module mounted on a USB dongle ground plane

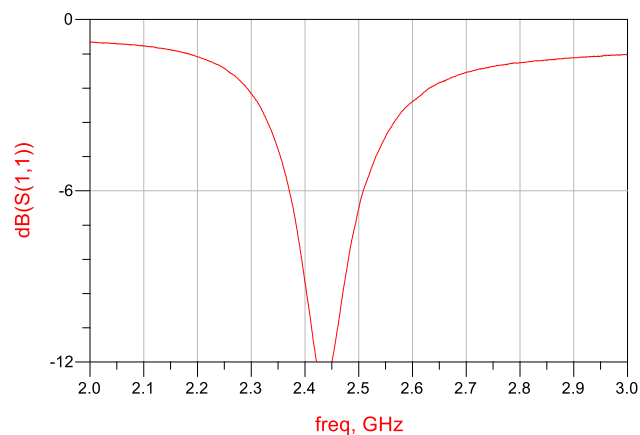

Radiation Pattern in 3 planes

Module mounted on a USB dongle ground plane

Gain measurement in dBi @ 2.45 GHz.

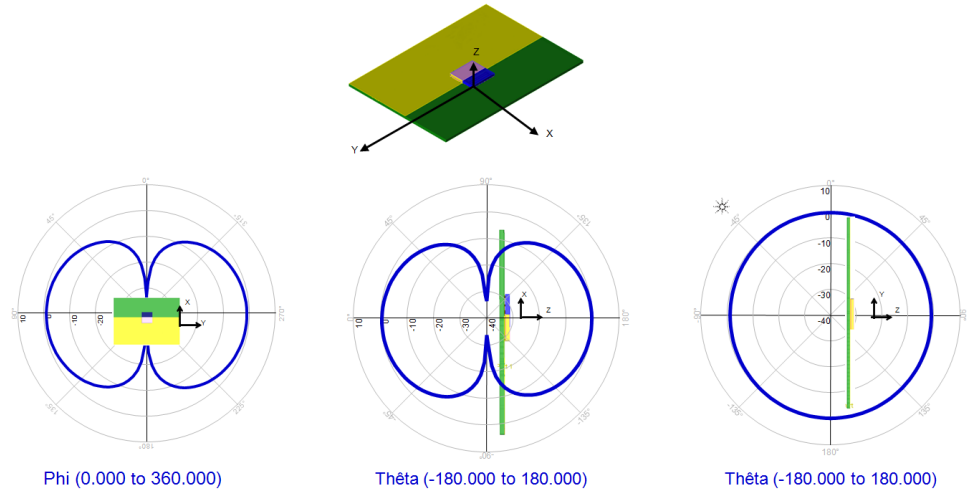

Ground Plane Effect Simulation

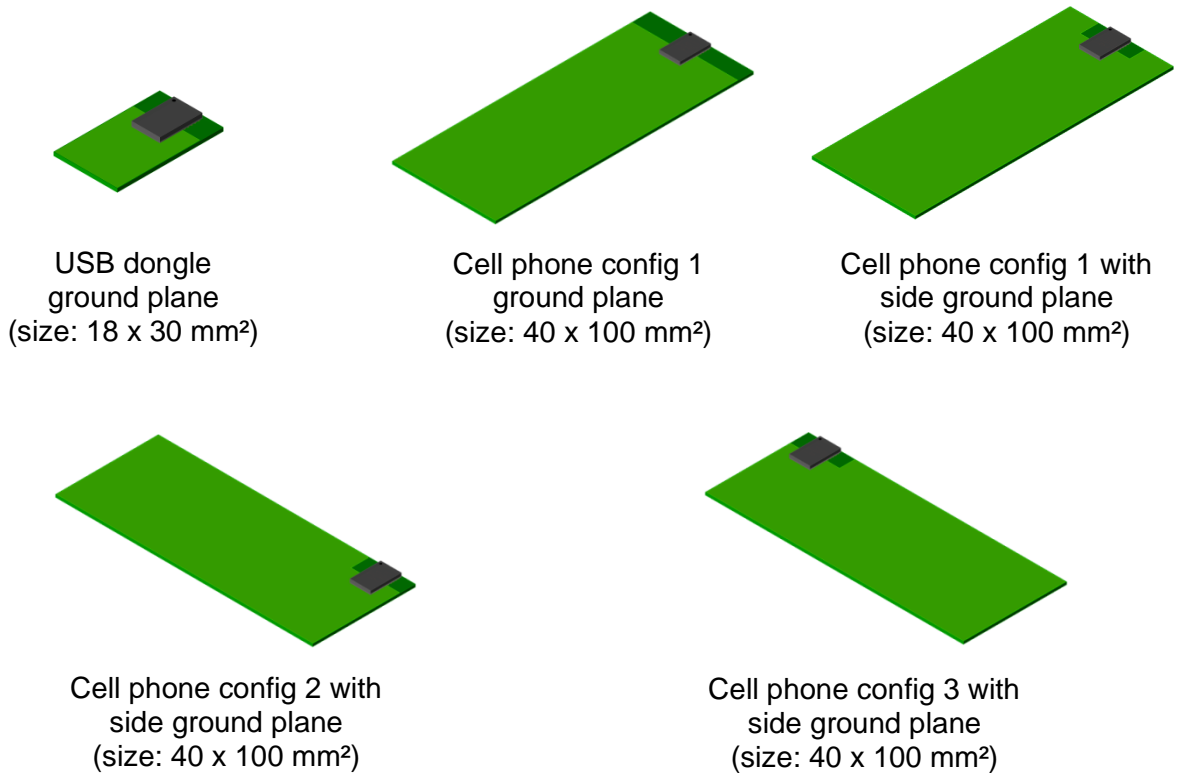

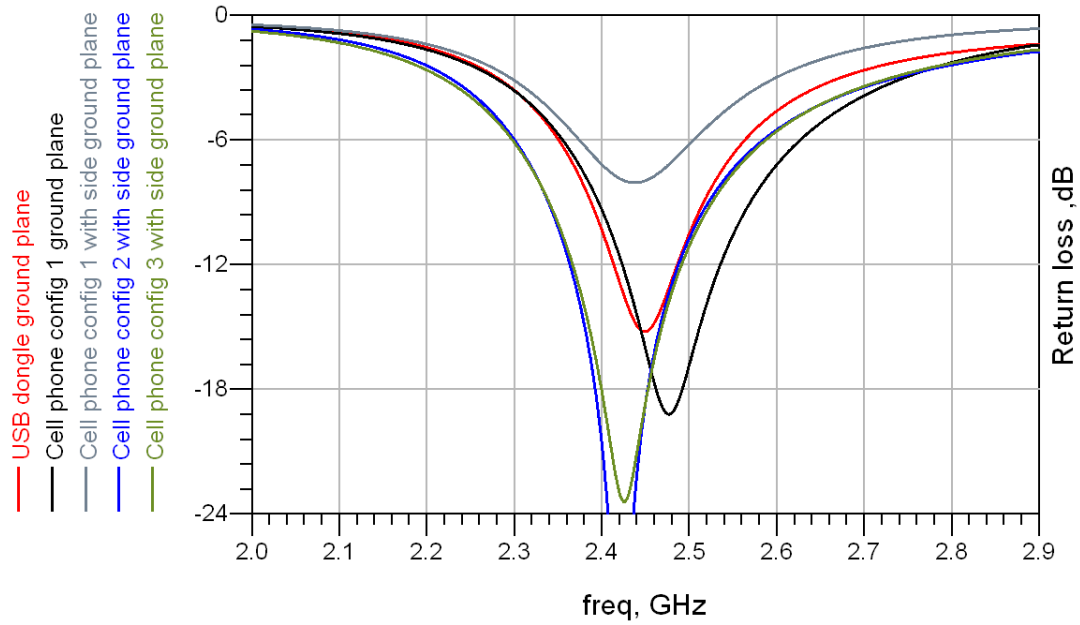

2.9. Electrical Schematic

Electrical schematic showing ISP2053 module connections

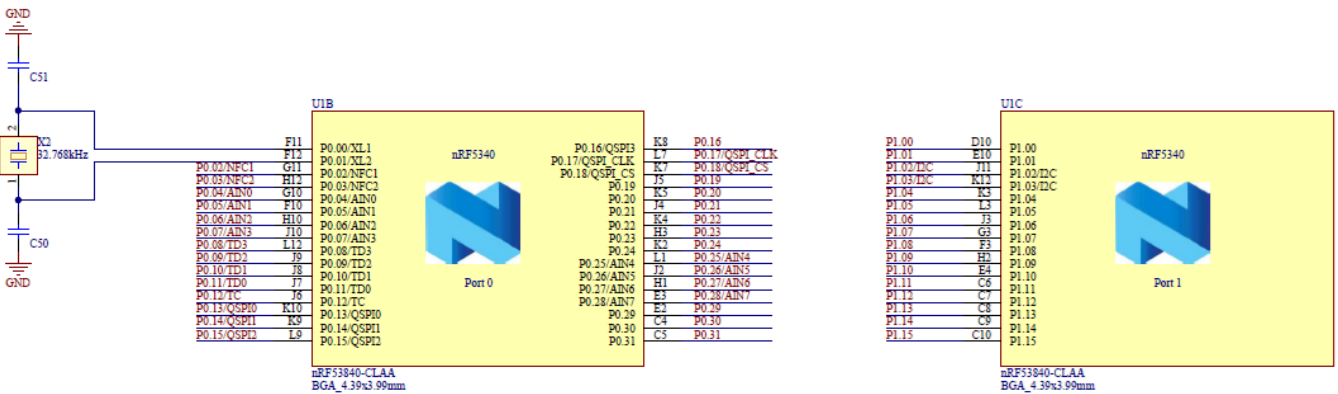
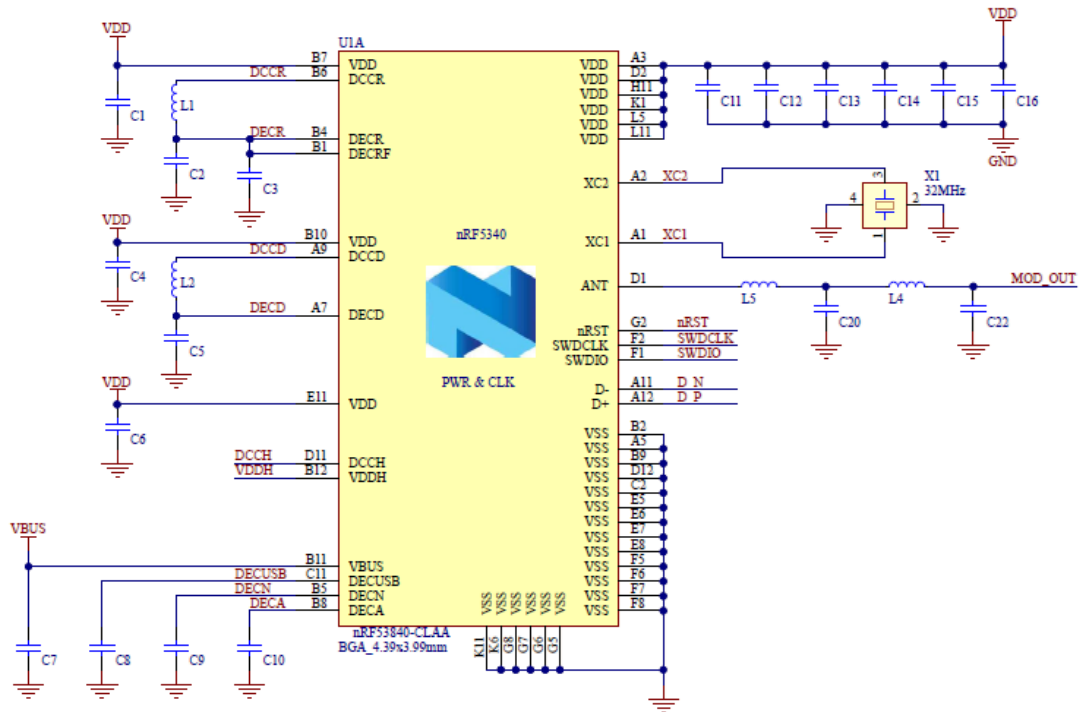

3. Pin Description

The module uses an LGA format with a grid of pads on a 0.65 mm pitch according to QFN Jedec standard. The NC pads are to be connected to isolated metal pads on the application PCB for mechanical stability and reliability (drop test).

Pin	Name	Pin function	Description
A1	VSS	Ground	Should be connected to ground plane on application PCB
A2	VBUS	USB Power	5V input for USB 3.3V regulator
A3	P1.03/I2C	Digital I/O TWI 1 Mbps	General purpose I/O pin High Speed TWI
A4	D+	USB Data	USB D+
A5	D-	USB Data	USB D-
A6	VDDH	Power	High voltage power supply (1.7 – 3.6V)
A7	DCCH	Power	High voltage DC/DC converter output
A8	P0.02/NFC1	Digital I/O NFC	General purpose I/O pin NFC antenna connection
A9	P0.03/NFC2	Digital I/O NFC	General purpose I/O pin NFC antenna connection
A10	P0.10/TD1	Digital I/O Trace Data	General purpose I/O pin Trace port output
A11	VSS	Ground	Should be connected to ground plane on application PCB
B2	P1.15	Digital I/O	General purpose I/O pin
B3	P0.06/AIN2	Digital I/O Analog Input	General purpose I/O pin SAADC/COMP/LPCOMP input
B4	P0.04/AIN0	Digital I/O Analog Input	General purpose I/O pin SAADC/COMP/LPCOMP input
B5	P1.01	Digital I/O	General purpose I/O pin
B6	P0.07/AIN3	Digital I/O Analog Input	General purpose I/O pin SAADC/COMP/LPCOMP input
B7	P1.00	Digital I/O	General purpose I/O pin
B8	P0.05/AIN1	Digital I/O Analog Input	General purpose I/O pin SAADC/COMP/LPCOMP input
B9	P0.08/TD3	Digital I/O Trace Data	General purpose I/O pin Trace port output
B10	P1.02/I2C	Digital I/O TWI 1 Mbps	General purpose I/O pin High Speed TWI
C1	VDD	Power	Power supply (1.7 – 3.6V)
C2	P0.13/QSPI0	Digital I/O Quad SPI	General purpose I/O pin Quad SPI
C3	P0.19	Digital I/O	General purpose I/O pin
C4	P0.15/QSPI2	Digital I/O Quad SPI	General purpose I/O pin Quad SPI
C5	P0.14/QSPI1	Digital I/O Quad SPI	General purpose I/O pin Quad SPI
C6	P0.16	Digital I/O	General purpose I/O pin
C7	P0.09/TD2	Digital I/O Trace Data	General purpose I/O pin Trace port output

Pin	Name	Pin function	Description
C8	P0.11/TD0	Digital I/O Trace Data	General purpose I/O pin Trace port output
C9	P0.17/QSPI_CLK	Digital I/O Quad SPI	General purpose I/O pin Quad SPI
C10	P1.05	Digital I/O	General purpose I/O pin
C11	SWDIO	Digital I/O	Serial Wire Debug I/O for debug and programming
D1	P1.13	Digital I/O	General purpose I/O pin
D2	P0.12/TC	Digital I/O Trace Clock	General purpose I/O pin Trace clock
D3	P0.21	Digital I/O	General purpose I/O pin
D4	P0.18/QSPI_CS	Digital I/O Quad SPI	General purpose I/O pin Quad SPI
D5	P0.22	Digital I/O	General purpose I/O pin
D6	P0.20	Digital I/O	General purpose I/O pin
D7	P1.08	Digital I/O	General purpose I/O pin
D8	P1.09	Digital I/O	General purpose I/O pin
D9	P1.04	Digital I/O	General purpose I/O pin
D10	P0.24	Digital I/O	General purpose I/O pin
D11	SWDCLK	Digital Input	Serial Wire Debug clock input for debug and programming
E1	P1.14	Digital I/O	General purpose I/O pin
E2	P0.30	Digital I/O	General purpose I/O pin
E3	P0.31	Digital I/O	General purpose I/O pin
E4	P1.12	Digital I/O	General purpose I/O pin
E5	P1.11	Digital I/O	General purpose I/O pin
E6	P0.28/AIN7	Digital I/O Analog Input	General purpose I/O pin SAADC/COMP/LPCOMP input
E7	VSS	Ground	Should be connected to ground plane on application PCB
E8	P0.29	Digital I/O	General purpose I/O pin
E9	P0.27/AIN6	Digital I/O Analog Input	General purpose I/O pin SAADC/COMP/LPCOMP input
E10	P0.26/AIN5	Digital I/O Analog Input	General purpose I/O pin SAADC/COMP/LPCOMP input
E11	nRST	Reset	Reset pin
F1	VSS	Ground	Should be connected to ground plane on application PCB
F2	P1.06	Digital I/O	General purpose I/O pin
F3	P0.23	Digital I/O	General purpose I/O pin
F4	P1.07	Digital I/O	General purpose I/O pin
F5	P1.10	Digital I/O	General purpose I/O pin
F6	VSS	Ground	Should be connected to ground plane on application PCB
F7	OUT_ANT	Antenna I/O	This pin is connected to the internal antenna. It should be connected to Pin F8 OUT_MOD for normal operation
F8	OUT_MOD	Antenna I/O	This pin is the RF I/O pin of the BLE module. It should be connected to Pin F7 OUT_ANT for normal operation
F9	VSS	Ground	Should be connected to ground plane on application PCB
F10	P0.25/AIN4	Digital I/O Analog Input	General purpose I/O pin SAADC/COMP/LPCOMP input
F11	VSS	Ground	Should be connected to ground plane on application PCB
H* K* L*	NC	Not Connected	Isolated pad on application PCB for mechanical stability

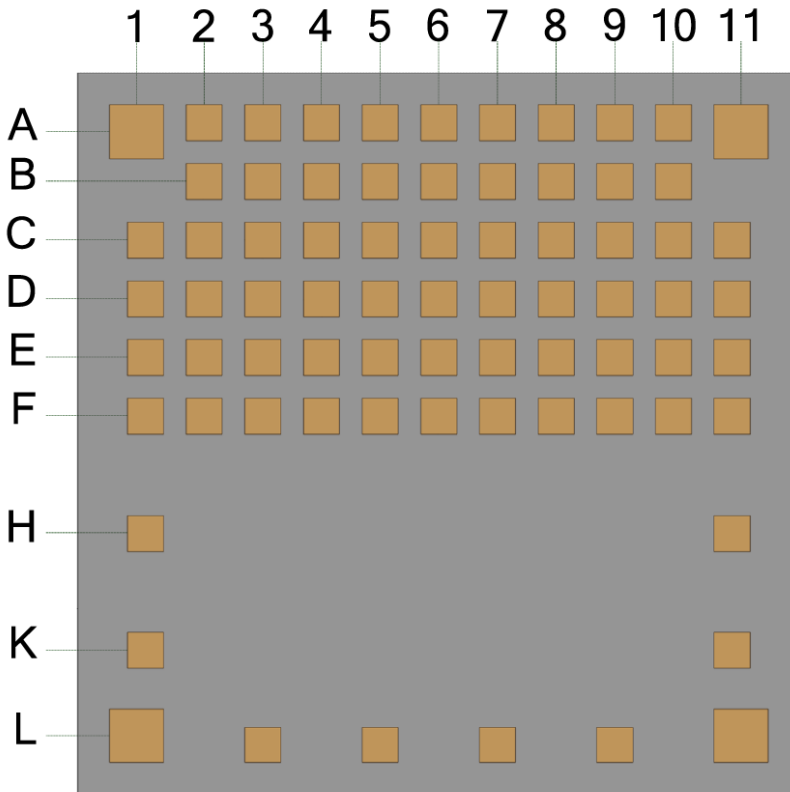

ISP2053
pad placement and pin assignment
for the LGA QFN package

TOP VIEW

4. Mechanical Outlines

4.1. Mechanical Dimensions

Package dimensions

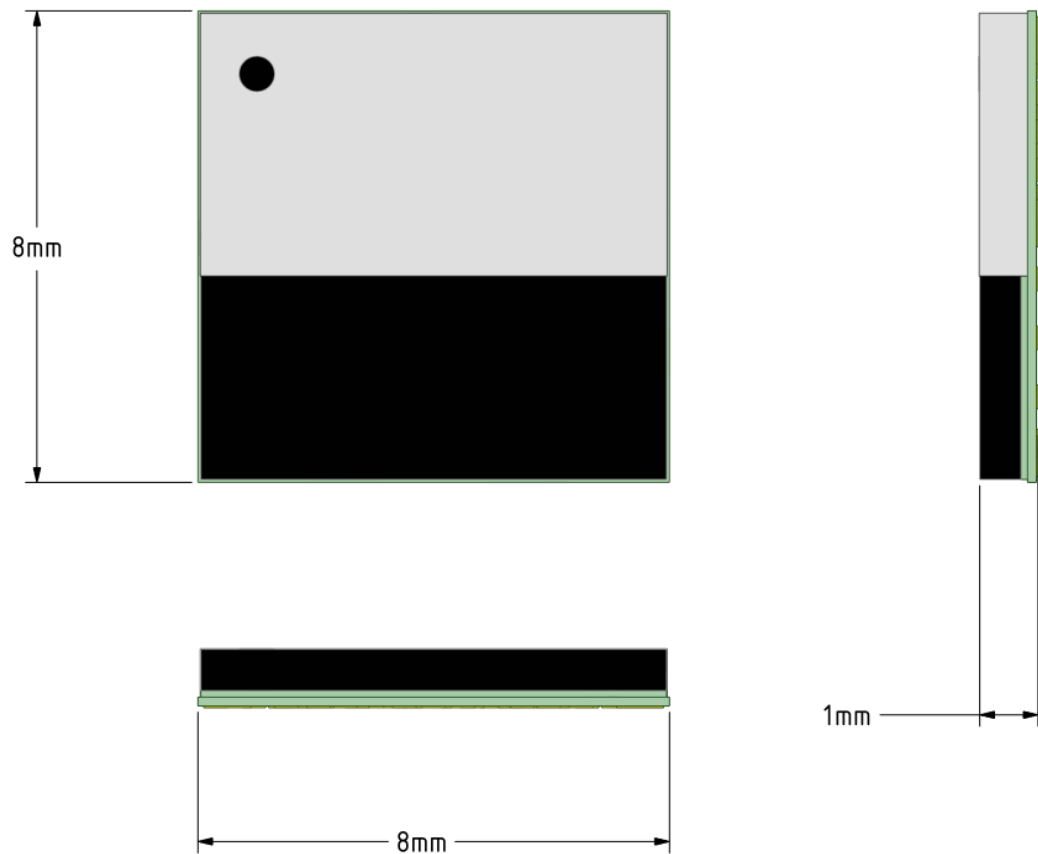

Dimensional drawing for 74-Pad LGA Package

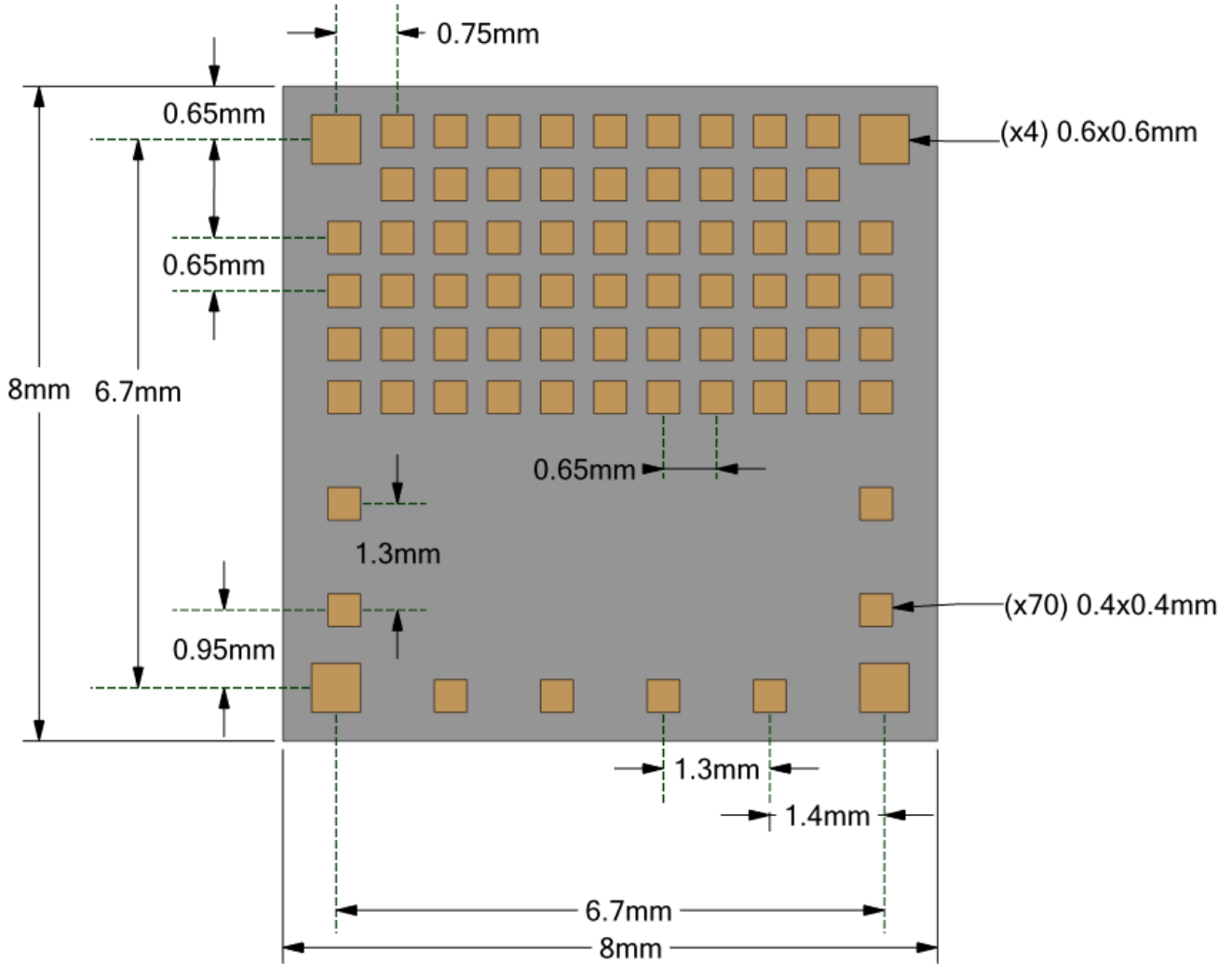

4.2. SMT Assembly Guidelines

For PCB Land Patterns and Solder Mask layout, Insight SiP recommends using the same dimensions as module pads.

For implementations in which most or all of the inner pads are used Insight SiP recommends the use of capped vias placed in the center of each pad.

For standard PCB types (no micro vias - all vias are top to bottom): we recommend to use nominal 0.4mm catch pads with 0.2mm vias. The vias should be plugged and capped to avoid solder wicking.

For HDI PCB types having micro vias on a layer by layer basis: we recommend to use 0.25mm catch pads and 0.1mm copper filled laser vias. Ideally the via is centered in the pad.

For reduced pinout implementations we recommend using external pads only. The use of a small number of internal pads can be accommodated by placing normal vias in the center of the device. In this case only the required pads should be Solder Mask opened and the vias tented with solder mask to prevent short circuits.

In general, we recommend NSMD solder mask with 50µm SM extension.

4.3. Antenna Performance

The internal antenna performance is optimized for an FR4 PCB of 1 mm thickness.

The module should be placed 1 mm from the PCB edge. And it is recommended to respect a metal exclusion zone to the edge of the board: no metal, no traces and no components on any application PCB layer except mechanical LGA pads.

When the module is placed on a large PCB dimension, 5mm lateral keep out zone is recommended. But when the PCB size is smaller, it is possible to place the module in either corner and reduce the lateral keep out zone as described below.

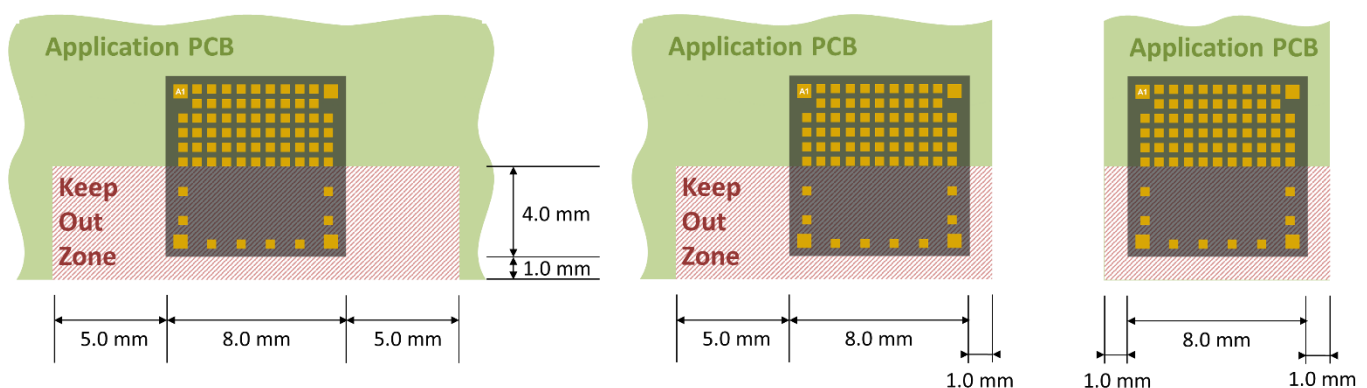

5. Product Development Tools

5.1. Hardware

In order to assist clients in developing their Bluetooth Smart solutions based on the ISP2053, Insight SiP offers a Development Kit containing:

- One Interface Board with integrated J-Link OB JTAG/SWD Emulator
- NFC antenna
- One Test Board
- Cables

Using this development kit, product developers can start from a working solution to develop their own products. Time to market is saved by avoiding commencing from a blank sheet of paper. In addition, there may be some applications that use the hardware as is.

Please refer to the documentation for more information:

http://www.insightsip.com/fichiers_insightsip/pdf/ble/ISP2053/isp_ble_DS2053_DK.pdf

5.2. Firmware

ISP2053 supports Bluetooth Low Energy protocol stacks. It also provides extensive software support for ANT, ZIGBEE and THREAD applications as well as 2.4 GHz protocol stacks, including Gazell. All are available as downloads at www.nordicsemi.com.

nRF Connect SDK is the development environment for nRF53 solutions. The SDK is running on the Zephyr operating system.

The SDK includes two implementations of the Bluetooth LE Controller:

✚ **Softdevice Controller:** Developed by Nordic Semiconductor, this controller supports features from the Bluetooth 5.2 specification.

List of supported features:

https://developer.nordicsemi.com/nRF_Connect_SDK/doc/latest/nrfxlib/softdevice_controller/README.html#softdevice-controller

✚ **Zephyr BLE Controller:** Open source developed by the Zephyr community, this controller support most of BLE features.

List of supported features:

https://developer.nordicsemi.com/nRF_Connect_SDK/doc/latest/zephyr/guides/bluetooth/overview.html#bluetooth-overview

More information about the nRF Connect SDK at:

https://developer.nordicsemi.com/nRF_Connect_SDK/doc/latest/nrf/index.html.

5.3. Development Tools

The following development tools and software are recommended for using and testing ISP2053 module:

- ✚ Nordic Semiconductor nRF Connect for Desktop:
Collection of application enabling programming, testing and debugging of Nordic Semi based products.
Downloadable at <https://www.nordicsemi.com/Software-and-tools/Development-Tools/nRF-Connect-for-desktop>.
- ✚ Segger Embedded Studio:
IDE for arm processors.
Downloadable from <https://www.segger.com/products/development-tools/embedded-studio>.
- ✚ Segger J-Link Lite:
Downloadable from <https://www.segger.com/downloads/jlink>.
- ✚ nRF Connect SDK:
nRF Connect SDK can be downloaded using nRF Connect for Desktop. It contains example of source code applications (C language).

6. Packaging & Ordering information

6.1. Marking

M	/N	:	I	S	P	2	0	5	3
T	T		Y	Y	W	W	R		

ISP2053	Part Number
TT	2 letters Module Type (see section 6.5)
YY	2 digits year number
WW	2 digits week number
R	1 letter Hardware revision

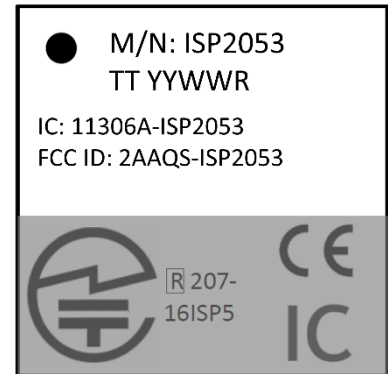

6.2. Prototype Packaging

For engineering samples and prototype quantities up to 99 units, deliveries are provided in thermoformed trays or cut tapes.

They are delivered in sealed pack with desiccant pack and humidity sensors. Please see section 7.2 for more information on moisture sensitivity.

Please order with "ST" code packaging suffix.



6.3. Jedec Trays

For pre-production volumes, ISP2053 are available in Jedec trays. They are delivered in sealed pack with desiccant pack and humidity sensors. These Jedec trays are also suitable for further baking at 125°C. Please see section 7.2 for more information on moisture sensitivity. Please order with "JT" code packaging suffix.

Refer to tray sizes below. Complete information on Jedec trays is available on request.

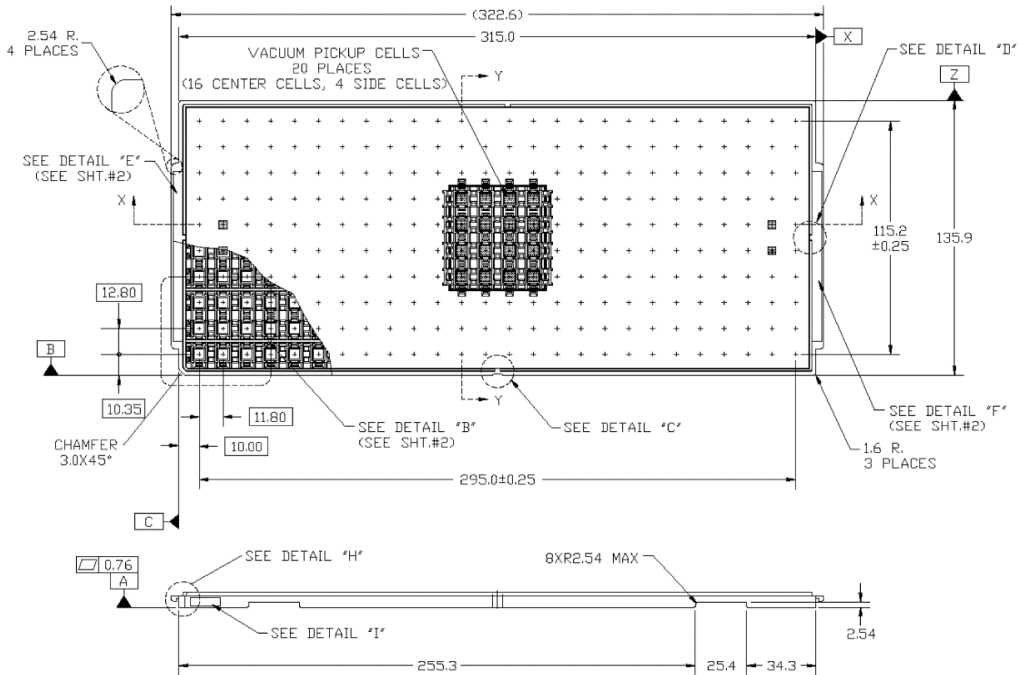

Top view position of modules within the tray.



6.4. Tape and Reel

ISP2053 are also available in Tape & Reel. They are delivered in sealed pack with desiccant pack and humidity sensors. Reels are proposed in standard quantities of 500 units (180mm / 7" reel) or 2000 units (330mm / 13" reel) only. Please order with "RS" code packaging suffix for 500-unit reels and "R2" for 2000-unit reels.

This packaging is not suitable for high temperature baking. Should it be necessary to recover MSL level, low temperature baking at 40°C as per Jedec-J-STD-033 is recommended.

Top view position of modules within the reel.

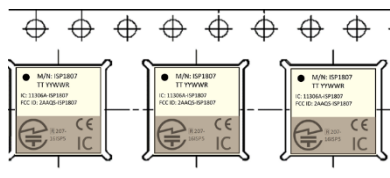

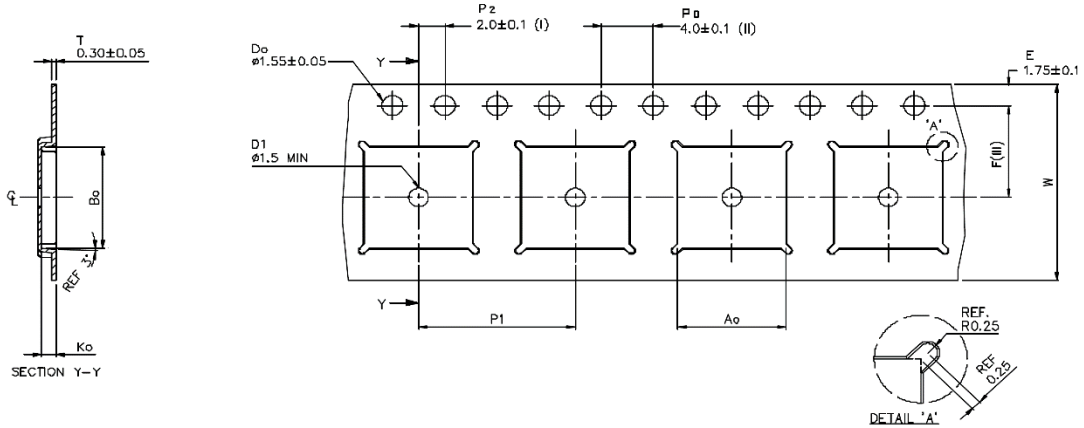

Ao	8.30	+/-0.1
Bo	8.30	+/-0.1
Ko	1.10	+/-0.1
F	7.50	+/-0.1
P1	12.00	+/-0.1
W	16.00	+/-0.3

- (I) Measured from centreline of sprocket hole to centreline of pocket.
 - (II) Cumulative tolerance of 10 sprocket holes is ± 0.20.
 - (III) Measured from centreline of sprocket hole to centreline of pocket.
 - (IV) Other material available.
- ALL DIMENSIONS IN MILLIMETRES UNLESS OTHERWISE STATED.

6.5. Ordering Information

I	S	P	2	0	5	3	-	T	T	-	Z	Z
I	S	P	2	0	5	3	-	A	X	-	E	B
I	S	P	2	0	5	3	-	A	X	-	T	B
I	S	P	2	0	5	3	-	A	X	-	S	T
I	S	P	2	0	5	3	-	A	X	-	J	T
I	S	P	2	0	5	3	-	A	X	-	R	S
I	S	P	2	0	5	3	-	A	X	-	R	2

Part Number
Long range version
Evaluation Board ⁽¹⁾
Test board ⁽¹⁾
Standard Tray or Cut Tape
Jedec Tray Packaging
Reel of 500 units
Reel of 2000 units

(1) Please see section 5.1 and refer to the following documentation for more information on development kit and test board:

http://www.insightsip.com/fichiers_insightsip/pdf/ble/ISP2053/isp_ble_DS2053_DK.pdf

7. Storage & Soldering information

7.1. Storage and Handling

- ✚ Keep this product away from other high frequency devices which may interfere with operation such as other transmitters and devices generating high frequencies.
- ✚ Do not expose the module to the following conditions:
 - Corrosive gasses such as Cl₂, H₂S, NH₃, SO₂, or NO_x
 - Extreme humidity or salty air
 - Prolonged exposure to direct Sunlight
 - Temperatures beyond those specified for storage
- ✚ Do not apply mechanical stress
- ✚ Do not drop or shock the module
- ✚ Avoid static electricity, ESD and high voltage as these may damage the module

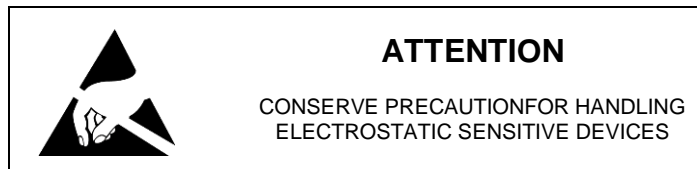

7.2. Moisture Sensitivity

All plastic packages absorb moisture. During typical solder reflow operations when SMDs are mounted onto a PCB, the entire PCB and device population are exposed to a rapid change in ambient temperature. Any absorbed moisture is quickly turned into superheated steam. This in vapor pressure can cause the package to swell. If the pressure exerted exceeds the flexural strength of the plastic mold compound, then it is possible to crack the package. Even if the package does not crack, interfacial delamination can occur.

ISP2053 has been tested MSL-3 according to standards. The products are delivered in dry pack with humidity sensor. When removing the trays or reels from the dry pack, the humidity sensor must be checked. Modules can then be exposed to ambient room conditions (approximately 30 °C/60%RH) during 168 hours before assembly on the PCB.

After this period of time, it is mandatory to bake the product before assembly according to Jedec J-STD-033. The baking process is 24 hours at 125°C for Jedec trays. For all other delivery formats, the baking process is 40°C for 8 days.



7.3. Soldering information

Recommendation for RoHS reflow process is according to Jedec J-STD-020 and 033 standard profiles.

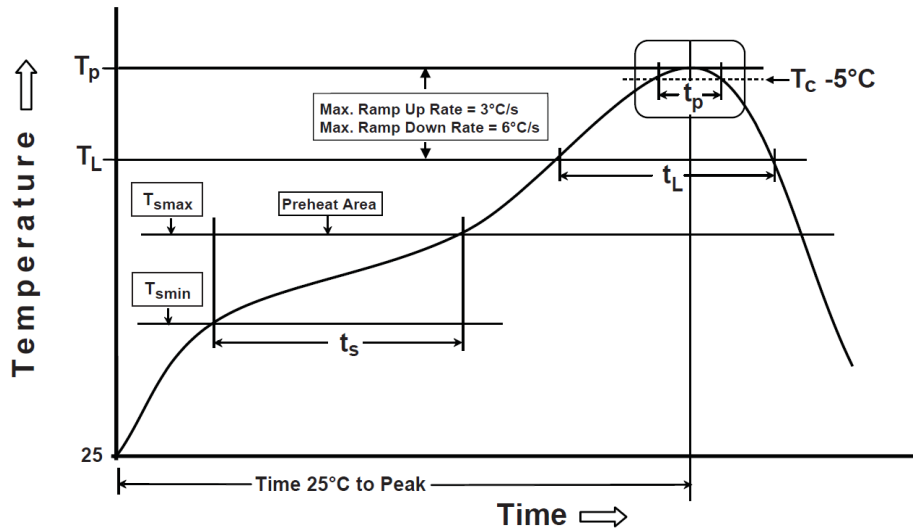

Preheat/Soak	
Temperature Min (T_{smin})	150 °C
Temperature Max (T_{smax})	200 °C
Time (t_s) from (T_{smin} to T_{smax})	60-120 sec
Ramp-up rate (T_L to T_p)	3 °C/sec max
Liquidous temperature (T_L)	217 °C
Time (t_L) maintained above T_L	60-150 sec

Peak package body temperature (T_p)	260°C (+0/-5°C)
Classification Temperature (T_c)	260 °C
Time (t_p) maintained above $T_c - 5$ °C	30 sec
Ramp-down rate (T_p to T_L)	6 °C/sec max
Time 25 °C to peak temperature	8 mn max

8. Quality & User information

8.1. Certifications

All below certificates can be downloaded on the website:

- + Bluetooth SIG Declaration : pending
- + CE Certified, DoC Insight SiP pending
- + TELEC Certified, pending
- + KCC Certification n° R-C-iNs-ISP2053 pending
- + FCC Certification n° 2AAQS-ISP2053 pending
- + IC Certification n° 11306A-ISP2053 pending
- + RoHS3 and Reach compliant, Ref TR191101 and TR200301
- + Conflict Mineral Declaration available, Ref TR180701

To support customers in their application certification, Insight SiP can provide test reports on request.

8.2. EC – CE Certification

This device can be operated in at least one Member State without infringing applicable requirements on the use of radio spectrum.

8.3. USA – User information

This intends to inform how to specify the FCC ID of our module “ISP2053” on the product. Based on the Public Notice from FCC, the host device should have a label which indicates that it contains our module. The label should use below example wording or any similar wording that expresses the same meaning:

“Contains FCC ID: 2AAQS-ISP2053”

The label of the host device should also include the below FCC Statement. When it is not possible, this information should be included in the User Manual of the host device:

*“This device complies with part 15 of the FCC rules. Operation is subject to the following two conditions.
(1) This device may not cause harmful interference
(2) This device must accept any interference received, including interference that may cause undesired operation.
Caution: Any Changes or modifications not expressly approved by the party responsible for compliance could void the user’s authority to operate the equipment.”*

8.4. Canada – User information

This intends to inform how to specify the IC ID of our module “ISP2053” on the product. According to Canadian standards “RSS-210” and “RSS-Gen”, the host device should have a label which indicates that it contains our module. The label should use below example wording or any similar wording that expresses the same meaning:

“Contains IC: 11306A-ISP2053”

The label of the host device should also include the below IC Statement. When it is not possible, this information should be included in the User Manual of the host device:

“This device complies with Industry Canada license-exempt RSS standard(s). Operation is subject to the following two conditions: (1) this device may not cause interference, and (2) this device must accept any interference, including interference that may cause undesired operation of the device.”

Le présent appareil est conforme aux CNR d'Industrie Canada applicables aux appareils radio exempts de licence. L'exploitation est autorisée aux deux conditions suivantes : (1) l'appareil ne doit pas produire de brouillage, et (2) l'utilisateur de l'appareil doit accepter tout brouillage radioélectrique subi, même si le brouillage est susceptible d'en compromettre le fonctionnement.”

8.5. RF Exposure Information

This equipment complies with FCC/IC radiation exposure limits set forth for an uncontrolled environment and meets the FCC radio frequency (RF) Exposure Guidelines in Supplement C to OET65 and RSS-102 of the IC radio frequency (RF) Exposure rules. This equipment has very low levels of RF energy that it deemed to comply without maximum permissive exposure evaluation (MPE).

8.6. Informations concernant l'exposition aux fréquences radio (RF)

La puissance de sortie émise par l'appareil de sans-fil est inférieure à la limite d'exposition aux fréquences radio d'Industry Canada (IC). Ce module a également été évalué et démontré conforme aux limites d'exposition aux RF d'IC dans des conditions d'exposition à des appareils mobiles et/ou portables.

8.7. Discontinuity

Normally a product will continue to be manufactured as long as all of the following are true:

- The manufacturing method is still available.
- There are no replacement products.
- There is demand for it in the market.

In case of obsolescence, Insight SiP will follow Jedec Standard JSD-48. A Product Discontinuation Notice (PDN) will be sent to all distributors and made available on our website. After this, the procedure goes as follows:

- Last Order Date will be 6 months after the PDN was published.
- Last Shipment Date will be 6 months after Last Order Date, i.e. 12 months after PDN.

8.8. Disclaimer

Insight SiP's products are designed and manufactured for general consumer applications, so testing and use of the product shall be conducted at customer's own risk and responsibility. Please conduct validation and verification and sufficient reliability evaluation of the products in actual condition of mounting and operating environment before commercial shipment of the equipment. Please also pay attention (i) to apply soldering method that don't deteriorate reliability, (ii) to minimize any mechanical vibration, shock, exposure to any static electricity, (iii) not to overstress the product during and after the soldering process.

The products are not designed for use in any application which requires especially high reliability where malfunction of these products can reasonably be expected to result in personal injury or damage to the third party's life, body or property, including and not limited to (i) aircraft equipment, (ii) aerospace equipment, (iii) undersea equipment, (iv) power plant control equipment, (v) medical equipment, (vi) transportation equipment, (vii) traffic signal equipment, (viii) disaster prevention / crime prevention equipment.

The only warranty that Insight SiP provides regarding the products is its conformance to specifications provided in datasheets. Insight SiP hereby disclaims all other warranties regarding the products, express or implied, including without limitation any warranty of fitness for a particular purpose, that they are defect-free, or against infringement of intellectual property rights. Insight SiP customers agree to indemnify and defend Insight SiP against all claims, damages, costs and expenses that may be incurred, including without any limitation, attorney fees and costs, due to the use of products.

X-ON Electronics

Largest Supplier of Electrical and Electronic Components

Click to view similar products for [Bluetooth Modules - 802.15.1 category](#):

Click to view products by [Insight SiP manufacturer](#):

Other Similar products are found below :

[A2541R24A10GM](#) [CYBLE-212023-10](#) [BM78SPP05MC2-0002AA](#) [CYW20732S](#) [968EMB0019](#) [E73-2G4M08S1CX](#) [TB-03F-AT_Mesh](#)
[SPB228-D-1](#) [88980124](#) [NINA-B222-03B](#) [1327](#) [RN42HID-I/RM](#) [ENW-89829C3KF](#) [BLE113-A-V1](#) [SPBTLE-RFTR](#) [BM70BLE01FC2-](#)
[0B03AA](#) [ACN52832](#) [A2541E24A10GM](#) [450-0168R](#) [MOTG-BLUETOOTH](#) [ABBTM-2.4GHz-52-T](#) [ABBTM-2.4GHz-T](#) [ABBTM-2.4GHz-](#)
[T2](#) [ACN52840](#) [4076](#) [4077](#) [AFERO-BL24-01](#) [BLED112](#) [BM62SPKS1MC2-0001AA](#) [BM78SPPS5MC2-0002AA](#) [PX0880/1](#) [DAT12](#) [DG100](#)
[IOT EDGE GATEWAY](#) [ENW49D01A1KF](#) [ENW89857A1KF](#) [BT680F](#) [PBA31309V1.00 S LK64](#) [ATSAMB11-MR510CA](#)
[BM20SPKA1NBC-0001AA](#) [BM20SPKS1NBC-0001AA](#) [BM23SPKS1NB9-0B02AA](#) [BM70BLE01FC2-0B04AA](#) [BM77SPP03MC2-0007AA](#)
[BM77SPP03MC2-0008AA](#) [BM78SPPS5NC2-0002AA](#) [BM83SM1-00TA](#) [DM164146](#) [RN42NU-IRM](#) [RN42U-I/RM](#) [RN42XVP-I/RM](#)