

inspired LED **Mini Tiger Cub™ Screw Terminal**

Inspired LED's patented solderless **Tiger Paw Connectors** are the perfect solution for in-field LED customization and system design. These innovative accessories pair easily with Inspired LED flex strips to allow for a quick, convenient installation, making the perfect low-voltage lighting system for a snap!

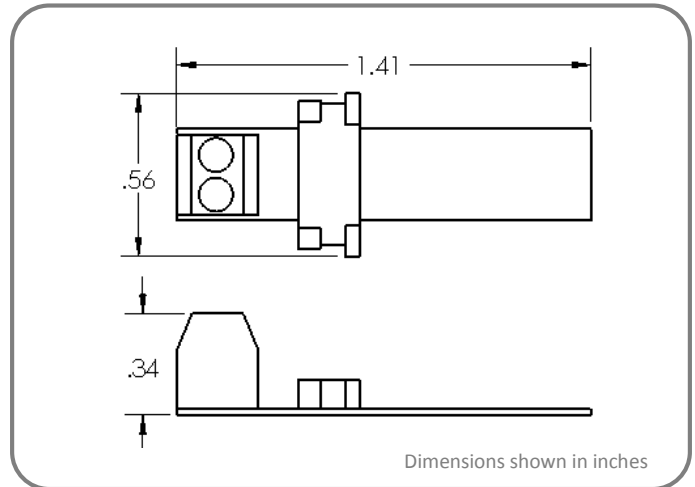
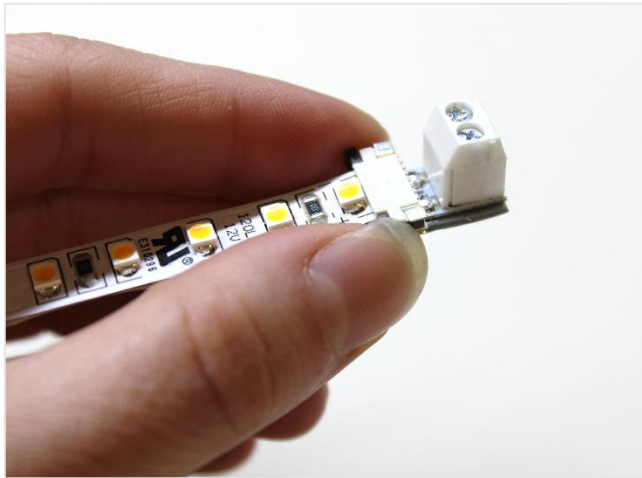

Product Specifications:

- Solderless termination of 8mm LED flex strips to 18-22 AWG wire
- Max Load- 5 AMPs
- Industry proven locking system meets shock and vibration requirements for IEC 60068-2-27
- U.S. Patent No. 8,714,772

Instructions:

1 Use scissors to cut LED strip to length along the copper solder pads, located over 3 LEDs

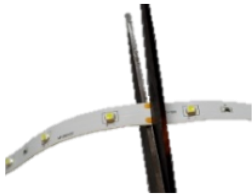

2 Take hold of black sliding latch and pull outward to open

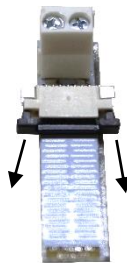

3 Peel back adhesive lining on LED strip

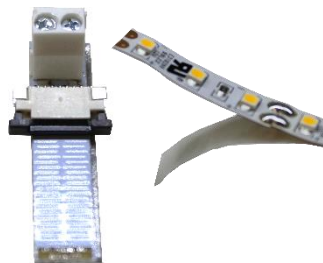

4 Taking note of (+) polarity of LEDs, insert flex strip into gap above the black sliding latch and beige top piece



5 Make sure LED strip is centered and fully inserted before sliding black latch firmly closed and pressing on adhesive



6 Use small screw driver to loosen screws on the top of connector piece



7 Strip cable back ¼" to expose (+) and (-) wire, (if using Inspired LED cable, white writing indicates positive polarity)

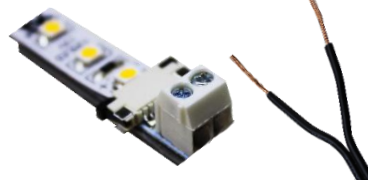

8 Insert wire (matching polarity) tighten screws and connect to class 2 power source to verify connections, then install LED flex strips as needed

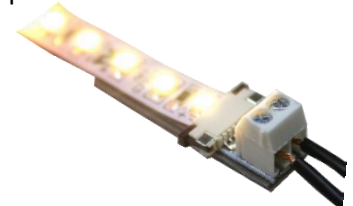

Troubleshooting: If LEDs are flickering, double check connection to be sure flex is fully inserted and secured, if no lights turn on check to be sure polarities are properly matched

X-ON Electronics

Largest Supplier of Electrical and Electronic Components

Click to view similar products for [Lighting Connectors](#) category:

Click to view products by [Inspired LED](#) manufacturer:

Other Similar products are found below :

[293300-7](#) [293660-5](#) [CNX_H03_NTP](#) [30-9767-BU](#) [3605](#) [3-21030-1](#) [ZCH-110-RGB-I](#) [503471-0290](#) [ZCH-110-RGB-J](#) [217-0716-200](#)
[1954563-1](#) [1-293657-2](#) [2834036-1](#) [2834037-1](#) [1-2213222-4](#) [2-2213222-4](#) [2213222-4](#) [2834122-3](#) [2834122-5](#) [2834135-2](#) [FLA-R4142-30](#)
[FLA-R4162-30](#) [FLA-R2142-30](#) [FLA-R2162-30](#) [FLA-R2161-30](#) [FLA-R0161-30](#) [FLA-R0141-30](#) [FLA-R0142-30](#) [FLA-R0162-30](#) [FLA-C00-](#)
[00](#) [DGA00010553](#) [CNXV04NTP](#) [104128-0610](#) [503485-0000 \(Cut Strip\)](#) [503485-0000 \(Loose Piece\)](#) [503485-0000 \(MINI Reel\)](#) [1-2834074-2](#)
[1-2834074-3](#) [1357-AC PLUG W2C \(CHINA\)](#) [1357-AC PLUG W2 \(USA\)](#) [104266-0110](#) [CNXV02NTP](#) [2106212-1](#) [2-2834074-2](#) [104266-](#)
[0210](#) [293470-1](#) [293651-2](#) [293651-4](#) [1-2834006-2](#) [293651-1](#)