

Intel® RealSense™ Depth Camera SR300 Series Product Family

Datasheet

Intel® RealSense™ Depth Camera SR305, Intel® RealSense™ Depth Module SR300

Revision 002

June 2019



Intel products described herein. You agree to grant Intel a non-exclusive, royalty-free license to any patent claim thereafter drafted which includes subject matter disclosed herein.

No license (express or implied, by estoppel or otherwise) to any intellectual property rights is granted by this document.

Intel technologies' features and benefits depend on system configuration and may require enabled hardware, software or service activation. Performance varies depending on system configuration. No computer system can be absolutely secure. Check with your system manufacturer or retailer or learn more at intel.com.

Intel technologies may require enabled hardware, specific software, or services activation. Check with your system manufacturer or retailer.

The products described may contain design defects or errors known as errata which may cause the product to deviate from published specifications. Current characterized errata are available on request.

Intel disclaims all express and implied warranties, including without limitation, the implied warranties of merchantability, fitness for a particular purpose, and non-infringement, as well as any warranty arising from course of performance, course of dealing, or usage in trade.

All information provided here is subject to change without notice. Contact your Intel representative to obtain the latest Intel product specifications and roadmaps.

Copies of documents which have an order number and are referenced in this document may be obtained by calling 1-800-548-4725 or visit www.intel.com/design/literature.htm.

Intel and the Intel logo, Intel® Core™, Intel® Atom™, trademarks of Intel Corporation in the U.S. and/or other countries.

*Other names and brands may be claimed as the property of others.

© 2019 Intel Corporation. All rights reserved.

Contents

1	Description and Features	8
2	Introduction	9
	2.1 Purpose and Scope of this Document.....	9
	2.2 Terminology	9
	2.3 Coded Light Depth Technology Overview	9
	2.4 Camera System Block Diagram.....	10
	2.5 Intel® RealSense™ Depth Module SR300	11
	2.6 Intel® RealSense™ Depth Camera SR305.....	12
3	Component Specification	13
	3.1 Depth Camera System Components	13
	3.2 Host Platform	13
	3.3 Clock.....	13
	3.4 Flash Memory	13
	3.5 Depth Module.....	13
	3.5.1 Infrared Imager.....	15
	3.5.2 Infrared Projector	15
	3.5.3 Color Sensor	16
	3.5.4 Depth Module Connector	16
	3.5.5 Depth Module Label	17
	3.5.6 Stiffener	18
	3.5.7 Other Stereo Depth Module Components	18
	3.5.8 Mechanical Dimensions.....	18
	3.5.9 Depth Module Power Sequence.....	18
	3.5.10 Depth Module Storage and Operating Conditions	19
	3.6 Intel® RealSense™ Depth Camera SR305.....	20
	3.6.1 Camera Mechanical Dimensions.....	21
	3.6.2 Intel® RealSense™ Depth Camera SR305 Thermals	21
	3.6.3 Intel® RealSense™ Depth Camera SR305 Storage and Operating Conditions	21
	3.6.4 Intel® RealSense™ Depth Camera SR305 Product Identifier and Material Code.....	22
	3.6.5 Camera Lens Cleaning Procedure.....	22
4	Functional Specification	23
	4.1 Vendor Identification (VID) and Device Identification (DID).....	23
	4.2 Camera Video Stream Formats	23
	4.3 Data Streams	24
	4.3.1 Fast VGA Depth Mode	25
	4.3.2 Frame Latency	25
	4.3.3 Temporal Synchronization.....	25
	4.4 Depth Field of View (FOV)	26
	4.5 Measured Power	26
	4.6 Depth Start Point (Ground Zero Reference)	26
	4.7 Depth Camera Functions.....	27
	4.8 Color Camera Functions	28
5	Firmware	30

5.1	Update	30
5.1.1	Update Limits	30
5.2	Recovery	30
6	Software.....	31
6.1	Intel® RealSense™ Software Development Kit 2.0.....	31
7	System Integration	32
7.1	System Level Block Diagram	32
7.2	SR300 System Integration	32
7.2.1	SR300 Motherboard Connection.....	32
7.2.2	USB 3 Receptacle	33
7.2.3	USB 3 High Speed Cable Assembly	34
7.2.4	Transmit to Receive Crossover	34
7.2.5	Motherboard Receptacle	35
7.2.6	Power Requirements	36
7.3	Thermals	36
7.4	Module Mounting Guidance	37
7.4.1	Thermal Interface Material (TIM) Mount	37
7.5	Passive Heat Spreader.....	37
7.6	Attachment and Alignment.....	37
7.7	Through-Holes, Cover Design and Material Guidance	38
7.7.1	Cover Material Transmission	39
7.8	Gaskets	40
7.8.1	Dust Protection	40
7.8.2	Acoustics	40
7.9	Grounding.....	40
7.10	Firmware Recovery	41
7.11	Infrared Projector Interference	41
7.12	Handling Conditions	42
8	Regulatory Compliance.....	43
8.1	System Laser Compliance	43
8.1.1	Certification Statement.....	43
8.1.2	Explanatory Label	43
8.1.3	Cautionary Statements.....	43
8.1.4	Manufacturer’s Information	44
8.1.5	US FDA Accession Number.....	44
8.1.6	NRTL Statement	44
8.2	Ecology Compliance	45
8.2.1	China RoHS Declaration.....	45
8.2.2	EU RoHS Declaration.....	46
8.2.3	Waste Electrical and Electronic Equipment	46
8.3	USB Certification Compliance	46
9	Mechanical Drawings.....	47
10	Appendix A – SR300 Schematic Checklist	49
11	Appendix B – SR300 Cable Drawings.....	51
12	Appendix C - SR300 USB Adapter	52
12.1	Design Reference.....	53

Figures

Figure 2-1. Depth Video Data Flow.....	10
Figure 2-2. Depth Camera System Block Diagram.....	10
Figure 3-1. Depth Module (Intel® RealSense™ Depth Module SR300) Front View	14
Figure 3-2. Depth Module (Intel® RealSense™ Depth Module SR300) Rear View	14
Figure 3-3. Depth Module Power Sequence	18
Figure 3-4. Intel® RealSense™ Depth Camera SR305	20
Figure 4-1. Depth Module Depth Start Point Reference	26
Figure 4-2. Depth Camera Depth Start Point Reference	27
Figure 7-1. System Block Diagram.....	32
Figure 7-2. SR300 Motherboard Connection (Illustration).....	33
Figure 7-3. Receptacle Ground Bar Motherboard Connections	35
Figure 7-4. Thermocouple Test Locations	36
Figure 7-5: Passive Heat Spreader	37
Figure 7-6: Attachment Area and Alignment Pins	38
Figure 7-7: Through-Hole Design Considerations	38
Figure 7-8: No Ground or Electrical Contact	41
Figure 7-9. Firmware Recovery Sequence	41
Figure 7-10: Interference	42
Figure 9-1. Intel® RealSense™ Depth Module SR300.....	47
Figure 9-2. Intel® RealSense™ Depth Camera SR305	48
Figure 11-1: Cable Mechanical Drawing	51
Figure 12-1: SR300 Adapter 3D.....	52
Figure 12-2: SR300 Adapter 2D.....	53
Figure 12-3: SR305 USB Interposer Schematics	54

Tables

Table 2-1. Depth Module Product SKU Descriptions	11
Table 2-2. Depth Camera Product SKU Descriptions	12
Table 3-1. Component Descriptions.....	13
Table 3-2. Depth Module	14
Table 3-3. Depth Module Properties	15
Table 3-4. Infrared Imager Properties	15
Table 3-5. Infrared Projector Parameters	16
Table 3-6. Color Sensor Properties.....	16
Table 3-7. Module 10-pin Receptacle Details	16
Table 3-8. Depth Module Product Labeling	17
Table 3-9. Depth Module Label Fields	17
Table 3-10. Intel® RealSense™ Depth Module SR300 Product Identifier Code and Product Material Code	17
Table 3-11. Other Stereo Depth Module Components	18
Table 3-12. Intel® RealSense™ Depth Module SR300 Mechanical Dimensions.....	18
Table 3-13. Depth Module Storage and Operating Conditions	19
Table 3-14. Depth Camera SKU properties	20
Table 3-15. Intel® RealSense™ Depth Camera SR305 Mechanical Dimensions	21
Table 3-16. Max Skin Temperature	21
Table 3-17. Storage and Operating Conditions.....	21
Table 3-18. Product Identifier and Material Code	22

Table 4-1. Vendor ID and Device ID Table	23
Table 4-2: Depth and Infrared Data Formats.....	23
Table 4-3: Depth and Infrared Video Stream Configurations.....	23
Table 4-4. Image Formats	24
Table 4-5: Fast VGA Depth Mode	25
Table 4-6: Frame Latency	25
Table 4-7: Temporal Synchronization	25
Table 4-8. Depth Field of View.....	26
Table 4-9. Power- Ubuntu 16.04.....	26
Table 4-10. Power – Windows 10 (RS4).....	26
Table 4-11. Depth Module Depth Start Point	27
Table 4-12. Depth Cameras Depth Start Point	27
Table 4-13: Depth Properties	28
Table 4-14: Depth Property Values	28
Table 4-15: Standard Color Properties.....	28
Table 4-16: Standard Color Property Values.....	29
Table 7-1. USB 3 Receptacle Characteristics.....	33
Table 7-2. USB 3 Receptacle Pin Out	33
Table 7-3. USB 3 Plug Characteristics.....	34
Table 7-4. Cable Assembly Specification	34
Table 7-5. Cable Assembly Interconnect Properties	35
Table 7-6. Motherboard Receptacle Properties	35
Table 7-7. SR300 Power Requirements	36
Table 7-8. Power and TDP at Max Operating Mode	36
Table 7-9. Case Temperature Limits (Still Air)	36
Table 7-10: Component Transmission	39
Table 7-11. Electrostatic Discharge Caution	42
Table 10-1: Motherboard Connector Signals.....	49
Table 10-2: USB_RX Motherboard Signals.....	49
Table 10-3: USB_TX Motherboard Signals.....	49
Table 10-4: Power Signals	50
Table 11-1: Cable Ordering Logistics.....	51
Table 12-1: Mechanical Dimensions	52
Table 12-2: USB Interposer Designator Description.....	53

Revision History

Document Number	Revision Number	Description	Revision Date
334531	001	Initial release	May 2016
	002	Intel® RealSense™ Depth Camera SR305	May 2019

§ §

1 Description and Features

<u>Description</u>	<u>Features</u>
<p>The Intel® RealSense™ Depth Module SR300 and Intel® RealSense™ Depth Camera SR305 are short range, coded light 3D imaging system.</p> <p>The SR300 and SR305 models are optimized for best depth at 0.2-1.5m. As with other structured and coded light depth cameras, it functions best indoors or in a controlled lighting situation. It can also function well at lower light levels down to 0 Lux, since infrared light is being projected onto the scene from the camera.</p> <p>The small size of the SR300 subassembly provides system integrators flexibility to design into a wide range of products. And the SR305 camera device allows for an external attachment to a wide range of systems.</p> <p>The Intel® RealSense™ Depth Camera SR300 series is supported with cross-platform and open source Intel® RealSense™ SDK 2.0.</p> <p>Applications for the SR305 and SR300 include: face analytics and tracking, scanning and mapping, scene segmentation, hand and finger tracking and augmented reality.</p>	<ul style="list-style-type: none"> • Intel® RealSense™ Vision Processor • Up to 60FPS Depth at 640x480 (VGA) • Up to 200FPS Infrared at 640x480 (VGA) • Global shutter Color sensor up to 30FPS at 1920x1080 (FHD) • Depth range from 0.2 to 1.5m⁽¹⁾ • Infrared (IR) Laser Projector System • Green Activity LED⁽²⁾ • Infrared (IR) Laser Projector System (Class 1) <p>⁽¹⁾ Software may optimize within this range. ⁽²⁾ Green Activity LED available on SR300 module only</p> <p><u>Minimum System Requirements</u></p> <p>USB 3 Ubuntu*16.xx/Windows*10</p>



2 Introduction

2.1 Purpose and Scope of this Document

This document captures the specifications for the Intel® RealSense™ Depth Camera SR300 series family of products.

2.2 Terminology

Term	Description
Depth	Depth video streams are like color video streams except each pixel has a value representing the distance away from the camera instead of color information
FOV	Field Of View (FOV) describes the angular extent of a given scene that is imaged by a camera. A camera's FOV can be measured horizontally, vertically, or diagonally
Host System	Computer or SOC connected to depth camera
IR Projector	This refers to the source of infrared (IR) light used for illuminating a scene, object, or person to collect depth data.
Imagers	Depth camera system uses a pair of cameras referred as imagers to calculate depth. They are identical cameras configured with identical settings.
Image Signal Processor (ISP)	Image processing functions to enhance color image quality
SKU	Stock Keeping Unit (SKU) is a unique identifier for distinct products. It is often used in the scope of naming different versions of a device
TBD	To Be Determined. In the context of this document, information will be available in a later revision.

2.3 Coded Light Depth Technology Overview

The Intel® RealSense™ Depth Camera SR300 series depth camera uses multiple components to generate a depth image. To generate a depth frame, the IR projector illuminates the scene with a set of predefined, increasing spatial frequency coded IR vertical bar patterns. These patterns are warped by the scene, reflected back and captured by the IR camera. The IR camera pixel values are then processed by the vision processor to generate a depth frame. Subsequent depth frames create a video stream that is transmitted to the host system.

Figure 2-1. Depth Video Data Flow

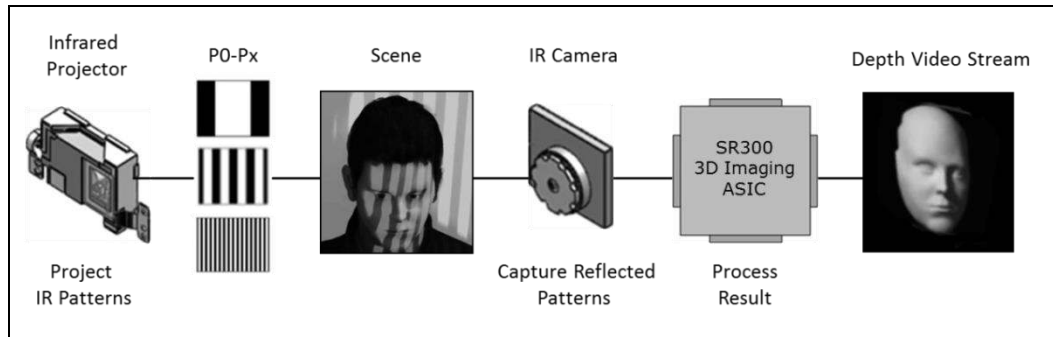

2.4 Camera System Block Diagram

The IR projector and IR camera operate in tandem using coded light patterns to produce a 2D array of monochromatic pixel values. These values are processed by the vision processor to generate depth and/or infrared video frames which are transmitted to the host via USB3.

The color camera consists of a chromatic sensor and an image signal processor which captures and processes chromatic pixel values. These values generate color video frames which are transmitted to the vision processor and then transmitted to the host via USB3. The color camera can function independently from the infrared camera or function synchronously to create color + infrared + depth video frames.

Figure 2-2. Depth Camera System Block Diagram

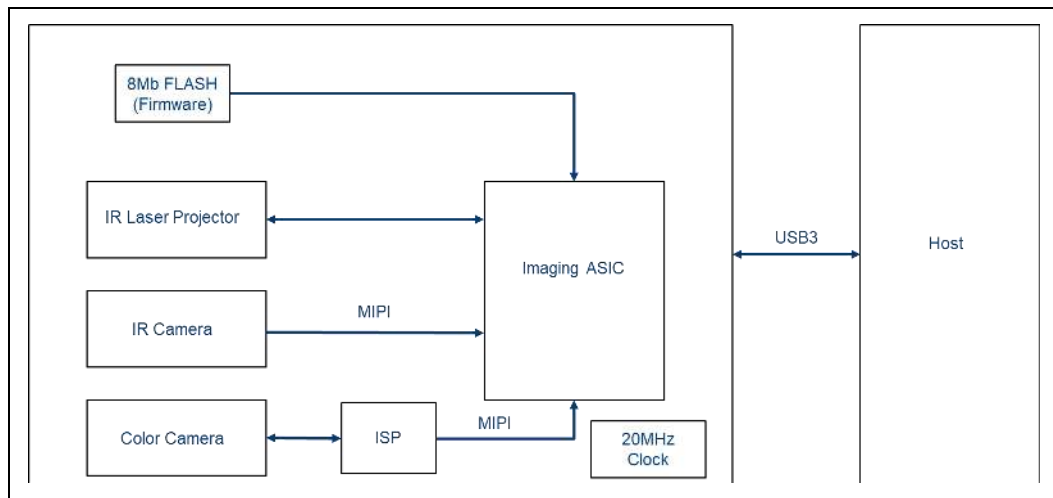

2.5 Intel® RealSense™ Depth Module SR300

Table below describes main components that make up the different depth module SKUs

Table 2-1. Depth Module Product SKU Descriptions

Component	Subcomponent	SR300
Intel® RealSense™ Vision Processor	-	✓
Intel® RealSense™ Depth Module	IR Imager	✓
	IR Projector	✓
	Color Imager	✓

2.6 Intel® RealSense™ Depth Camera SR305

Table below describes main components that make up the different camera SKUs:

Table 2-2. Depth Camera Product SKU Descriptions

Component	Subcomponent	Intel® RealSense™ Depth Camera SR305
Intel® RealSense™ Vision Processor	-	✓
Intel® RealSense™ Depth Module SR300	IR Imager	✓
	IR Projector	✓
	Color Imager	✓

§ §

3 Component Specification

3.1 Depth Camera System Components

Table 3-1. Component Descriptions

Component	Description
Host	Host platform that receives Depth and other data streams from SR300 device
Clock	20MHz clock source for vision processor
Flash Memory	8Mb Flash memory for firmware storage
Depth Module	Camera module with vision processor, IR imager, Color imager, IR projector enclosed in a stiffener
Power Delivery	Circuitry on board to deliver and manage power to Depth Module
Depth Connector and Interposer	10 pin connector on Depth module for connection with host platform or interposer with USB3 connection

3.2 Host Platform

The host platform interface to depth module is either direct connection to 10 pin connector which are USB3 signals or interposer card to provide an external USB3 connection. To ensure the best of quality of service, the depth module must be connected to a dedicated USB 3 root port within the host system.

3.3 Clock

The vision processor requires a single 20 MHz clock oscillator.

3.4 Flash Memory

The depth module requires 8Mbit Flash Memory for its firmware storage.

3.5 Depth Module

The depth module components are described in Table 3-10. The depth printed circuit board and components are encapsulated in a common metal stiffener.

Table 3-2. Depth Module

Component	Description
Vision Processor	USB3 only, primary interface to subassembly components
IR Imager	640x480 (VGA) monochromatic infrared sensor
Infrared (IR) Projector	Class 1 laser compliant coded light infrared projector system
Color Sensor	1920x1080 (FHD) chromatic sensor with discrete ISP
Depth Module Connector	10 pin connector
Activity LED	530nm green LED, illuminates when transmitting video over USB3
Cable Receptacle	10pin connector to system cable assembly
Alignment Holes	Round and oval holes to secure placement via system alignment pins
Stiffener	Reinforcement housing to keep imagers aligned
Label	Manufacture and product identifier information
Other Components	Laser Driver, EEPROM, Voltage Regulators, etc.

Figure 3-1. Depth Module (Intel® RealSense™ Depth Module SR300) Front View

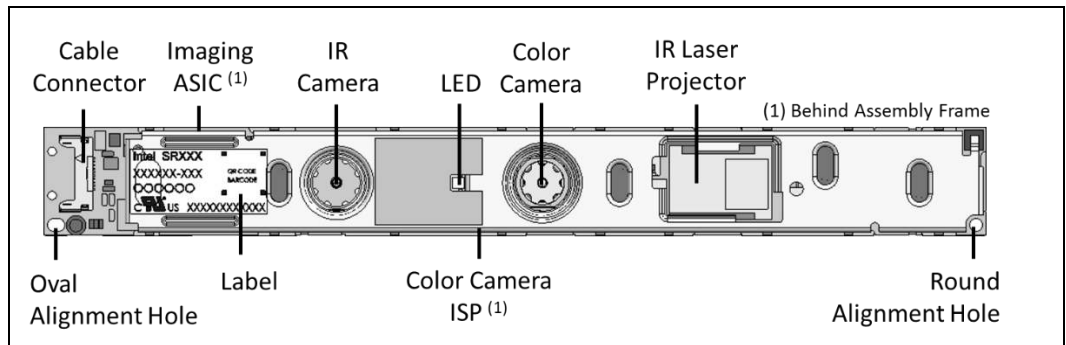

Figure 3-2. Depth Module (Intel® RealSense™ Depth Module SR300) Rear View

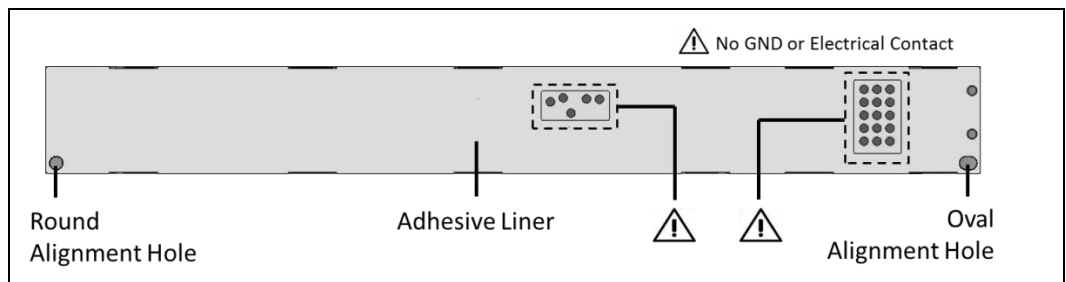

Table 3-3. Depth Module Properties

Stereo Module	Intel® RealSense™ Depth Module SR300
Depth FOV (degrees)	H:69±3 / V:54±2
IR Projector FOV	H:72.5±2 / V:60±4
IR Sensor FOV	H:73±4/ V:59±2 / D:90±4.5
Color Sensor FOV	H:68±2/ V:41.5±2 / D:75±4
Module Dimensions (mm)	X=110±0.2mm Y=12.6±0.1mm Z=4.1mm

NOTE:

- H – Horizontal FOV, V – Vertical FOV, D – Diagonal FOV, X – Length, Y – Breadth, Z – Thickness

3.5.1 Infrared Imager

Table 3-4. Infrared Imager Properties

Parameter	Camera Sensor Properties
Active Pixels	640 × 480
Sensor Aspect Ratio	4:3
Format	1/6"
F Number	1.9
Focal Length	1.67mm
Filter Type	IR Band Pass
Focus	Fixed
Shutter Type	Global Shutter
Signal Interface	MIPI CSI-2, 4X Lanes
Horizontal Field of View	73°±4
Vertical Field of View	59°±2
Diagonal Field of View	90°±4.5

3.5.2 Infrared Projector

The infrared projector meets class 1 laser safety under normal operation. The power delivery and laser safety circuits are on the depth module.

Table 3-5. Infrared Projector Parameters

Parameter	Properties
Projector	Infrared
Laser Controller	PWM
Laser Wavelength	860nm Nominal
Laser Compliance	Class 1, IEC 60825-1:2014 Ed 3
Horizontal Field of Projection	72.5°±2
Vertical Field of Projection	60°±4
Inclination	5°±2° Yaw Tilt (Towards IR Imager)

3.5.3 Color Sensor

Table 3-6. Color Sensor Properties

Parameter	Camera Sensor Properties
Color Image Signal Processor	Discrete
Active Pixels	1920 X 1080
Sensor Aspect Ratio	16:9
Format	1/6"
F Number	2.0
Focal Length	1.88mm
Filter Type	IR Cut Filter
Focus	Fixed
Shutter Type	Rolling Shutter
Signal Interface	MIPI CSI-2, 2X Lanes
Horizontal Field of View	68°±2
Vertical Field of View	41.5°±2
Diagonal Field of View	75°±4
Inclination	±1° Yaw/Pitch Tilt

3.5.4 Depth Module Connector

The depth module connector provides signal and power interface to the depth module.

Table 3-7. Module 10-pin Receptacle Details

Parameter	Description	Diagram
Number of Contacts	10	

Parameter	Description	Diagram
Part Number	20347-310E-12R	
Manufacturer Website	www.i-pex.com	

3.5.5 Depth Module Label

Table 3-8. Depth Module Product Labeling

<p>For illustration purpose only, subject to change</p>	<table border="1"> <thead> <tr> <th></th> <th>Dimension</th> <th>Value</th> <th>Unit</th> </tr> </thead> <tbody> <tr> <td>A</td> <td>Label Width</td> <td>7.0</td> <td>mm</td> </tr> <tr> <td>B</td> <td>Label Height</td> <td>7.0</td> <td>mm</td> </tr> <tr> <td>C</td> <td>Scan Code Width</td> <td>3.5</td> <td>mm</td> </tr> <tr> <td>D</td> <td>Scan Code Height</td> <td>3.5</td> <td>mm</td> </tr> </tbody> </table>		Dimension	Value	Unit	A	Label Width	7.0	mm	B	Label Height	7.0	mm	C	Scan Code Width	3.5	mm	D	Scan Code Height	3.5	mm
		Dimension	Value	Unit																	
A	Label Width	7.0	mm																		
B	Label Height	7.0	mm																		
C	Scan Code Width	3.5	mm																		
D	Scan Code Height	3.5	mm																		
<p style="text-align: center;">Scan Code Format XXXXXXXXXXXXOOOOOXXXXXXXX-XXX</p>																					

Table 3-9. Depth Module Label Fields

Group	Field	Description	Type
Company	Intel	Manufacturer	Static
Model Number	SR300	Camera Model Number	Static
Product Assembly Number	XXXXXX	Product Identifier Code	Static
	-XXX	Manufacture Configuration Code	Dynamic
	OOOOOO	Product Material Code	Static
Serial Number	XXXXXXXXXXXX	Manufacture Unit Code	Dynamic

Table 3-10. Intel® RealSense™ Depth Module SR300 Product Identifier Code and Product Material Code

Production	Product Identifier Code- Manufacture Configuration Code	Product Material Code
Intel® RealSense™ Depth Module SR300	H89061	943228

3.5.6 Stiffener

The stiffener maintains the precise alignment of the camera sensors and assists in subassembly rigidity. The stiffener consists of a bottom and a top plate. The stiffener is of stainless steel grade AISI 304.

3.5.7 Other Stereo Depth Module Components

Table 3-11. Other Stereo Depth Module Components

Component	Description
EEPROM	The module implements memory for storing the calibration data.
Alignment Holes	Secure placement and mounting to system/chassis/heat sink

3.5.8 Mechanical Dimensions

Table 3-12. Intel® RealSense™ Depth Module SR300 Mechanical Dimensions

Dimension	Min	Nominal	Max	Unit
Width	109.8	110	110.2	mm
Height	12.5	12.6	12.7	mm
Depth	3.8	4.1	4.4	mm
Flatness Tolerance	-	0.15	-	mm
Weight	-	8	-	gr

3.5.9 Depth Module Power Sequence

Figure 3-3. Depth Module Power Sequence

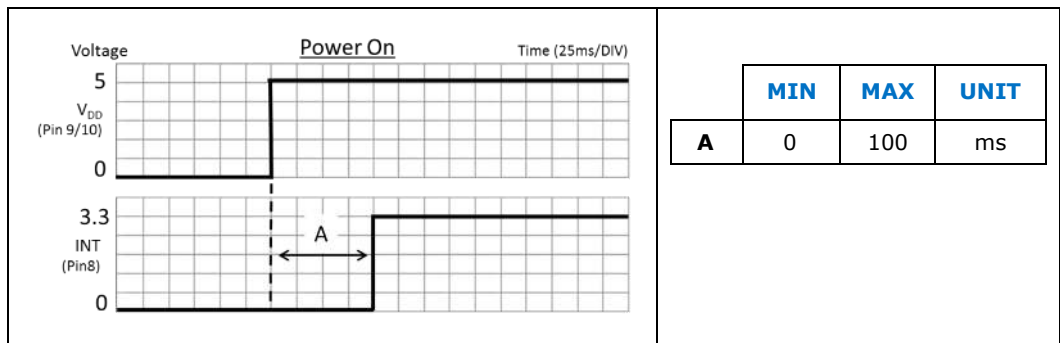

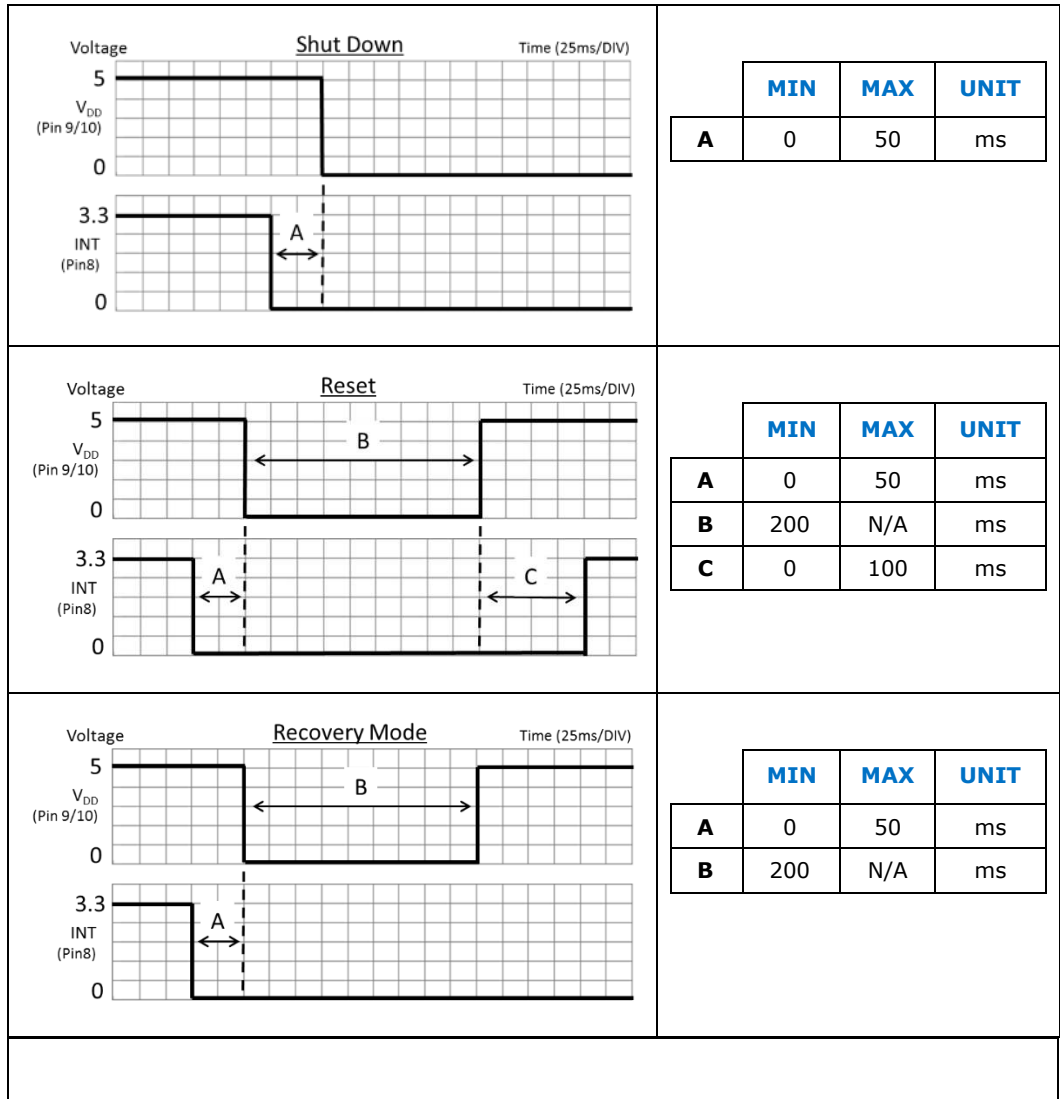

3.5.10 Depth Module Storage and Operating Conditions

Table 3-13. Depth Module Storage and Operating Conditions

Condition	Description	Min	Max	Unit
Storage (Ambient), Not Operating	Temperature (Sustained, Controlled) ⁽¹⁾	0	40	°C
	Temperature (Short Exposure) ⁽²⁾	-30	65	°C
	Humidity	Temperature/ RH: 30°C / 90%		
Case Temperature ⁽³⁾⁽⁴⁾⁽⁵⁾	Temperature	0	35	°C

NOTE:

- (1) Controlled conditions should be used for long term storage of product.
- (2) Short exposure represents temporary max limits acceptable for transportation conditions.
- (3) Case temperature limits must be met for all operating temperatures.
- (4) Case temperature is specified for the overall depth module
- (5) Case temperature 0° minimum and lower temperatures is non-condensing

3.6 Intel® RealSense™ Depth Camera SR305

Figure 3-4. Intel® RealSense™ Depth Camera SR305



Table 3-14. Depth Camera SKU properties

Cameras	Intel® RealSense™ Depth Camera SR305
Depth module	Intel® RealSense™ Depth Module SR300
Depth FOV (degrees)	H:69±3 / V:54±2
IR Projector FOV	H:72.5±2 / V:60±4
IR Sensor FOV	H:73±4/ V:59±2 / D:90±4.5
Color Sensor FOV	H:68±2/ V:41.5±2 / D:75±4

NOTE: H – Horizontal FOV, V – Vertical FOV, D – Diagonal FOV, X – Length, Y – Breadth, Z – Thickness

3.6.1 Camera Mechanical Dimensions

Table 3-15. Intel® RealSense™ Depth Camera SR305 Mechanical Dimensions

Dimension	Min	Nominal	Max	Unit
Width		140		mm
Height		26.1		mm
Depth		12		mm
Weight		70		gr

NOTE: Weight value only includes camera without accessory. Tripod bracket and tripod adds more weight to the camera.

3.6.2 Intel® RealSense™ Depth Camera SR305 Thermals

Table 3-16. Max Skin Temperature

Cameras	Max Skin Temperature (25 degree C Ambient in Open Environment)
SR305	45°C

3.6.3 Intel® RealSense™ Depth Camera SR305 Storage and Operating Conditions

Table 3-17. Storage and Operating Conditions

Condition	Description	Min	Max	Unit
Storage (Still Air), Not Operating	Temperature (Sustained, Controlled) ⁽¹⁾	0	40	°C
	Temperature (Short Exposure) ⁽²⁾	-30	65	°C
	Humidity	Temperature / RH: 30°C / 90%		
Operating (Still Air)	Temperature	0	35	°C

NOTE:

(1) Controlled conditions should be used for long term storage of product.

(2) Short exposure represents temporary max limits acceptable for transportation conditions.

3.6.4 Intel® RealSense™ Depth Camera SR305 Product Identifier and Material Code

Table 3-18. Product Identifier and Material Code

Production	Product Identifier Code- Manufacture Configuration Code	Product Material Code
Intel® RealSense™ Depth Camera SR305		999GTF

3.6.5 Camera Lens Cleaning Procedure

1. Do not use any chemical or water on the camera lens
2. Remove dust and dirt as much as possible from the lens with a lens blower brush.
3. Wipe with soft cloth or eyeglass lens wiper.

§§

4 Functional Specification

4.1 Vendor Identification (VID) and Device Identification (DID)

Table 4-1. Vendor ID and Device ID Table

Depth Module/Depth Camera	Vendor ID	Device ID
Intel® RealSense™ Depth Module SR300	8086	0x0AA5
Intel® RealSense™ Depth Camera SR305	8086	0x0B48

4.2 Camera Video Stream Formats

Table 4-2: Depth and Infrared Data Formats

FORMAT	KEY	TYPE	DESCRIPTION
Depth ⁽¹⁾	Z	16b UINT	Depth format equating to the 1/8mm sub-pixel distance from the device subassembly planar surface to the object.
Depth ⁽¹⁾	Z	32b FLOAT	Depth format equating to the absolute distance (mm) from the device subassembly planar surface to the object.
Infrared	I	10b UINT	IR format which equates to illuminating scene with a fully illuminated I1 pattern.
Texture ⁽²⁾	U,V	32b FLOAT	Surface map calculated by client software to project depth video pixel values onto the color video pixels.
Vertices ⁽²⁾	X,Y	32b FLOAT	Surface map calculated by client software to un-project each depth video pixel value into world coordinate space.
Confidence ⁽²⁾	C	4b UINT	Provides a per pixel confidence value, 0xF equals high confidence and 0x0 represents low confidence.
(1) The effective range of the camera is up to 1.5m, but the 16b UINT depth format is interpolated over an 8m range (or 1/8mm sub-pixel resolution). (2) The device uses client software to process the UV and XY surface maps as well as the Z FLOAT and C UINT formats. The UV and XY maps are calculated based on the calibration coefficients stored on the SR300. Confidence is sent as 4 bits within a single byte.			

All video stream formats are transmitted as 16b aligned formats from the camera.

Table 4-3: Depth and Infrared Video Stream Configurations

FORMAT	DEPTH	INFRARED	TEXTURE	VERTICES	CONFIDENCE
Z	16b/32b				
I		16b			

FORMAT	DEPTH	INFRARED	TEXTURE	VERTICES	CONFIDENCE
ZI	16b/32b	16b			
ZC	16b/32b				8b(C)
ZUV	16b/32b		32b+32b		
ZIUV ⁽¹⁾	16b/32b	16b	32b+32b		
ZXY	16b/32b			32b+32b	
ZIXY ⁽¹⁾	16b/32b	16b		32b+32b	
ZIUVXY ⁽¹⁾	16b/32b	16b	32b+32b	32b+32b	

(1) For these modes, the the Infrared data can be replaced with Confidence map data. Infrared and Confidence cannot be transmitted simultaneously for a given configuration.

4.3 Data Streams

Depth imaging system provides depth data to a host system. The imaging system has the ability to provide color and infrared streams also.

Table 4-4. Image Formats

Format	Resolution	Frame Rate (FPS)	Comment
Z	640x480 (VGA)	10,30,60	Depth
	640x480 (Fast VGA) ⁽¹⁾		
IR [I1]	640x480	30,60,120,200	Luminance
YUY2	1920x1080	10,30	Color Stream from RGB camera
	1280x720	10,30,60	
	960x540	10,30,60	
	848x480	10,30,60	
	640x480	10,30,60	
	640x360	10,30,60	
	424x240	10,30,60	
	320x240	10,30,60	
320x180	10,30,60		

NOTE:

All frame rates are expressed as nominal. Effective frame rates can vary depending on the exposure settings of the camera. Camera settings that increase the exposure time can decrease the effective frame rate.

(1) Fast VGA is enabled automatically based on exposure setting. This format will provide interpolated HVGA.

4.3.1 Fast VGA Depth Mode

Fast VGA mode is an interpolated HVGA format which is enabled when the exposure time is set below or equal to 8ms ($MvR \leq 8$). This mode is optimized for high motion scenes and will not degrade the effective frame rate from the camera.

Table 4-5: Fast VGA Depth Mode

DEPTH MODE	OUTPUT	MvR VALUE	EXPOSURE TIME	UNIT
Fast VGA	Interpolated HVGA	≤ 8	≤ 8	ms
VGA	VGA	> 8	> 8	ms

4.3.2 Frame Latency

The internal latency of the depth and/or infrared video stream can be up to one output frame compared to the color video stream when both cameras are streaming. The internal latency of the color video stream can be up to one output frame for only QVGA formats.

Table 4-6: Frame Latency

COLOR	DEPTH	INFRARED	FORMAT	LATENCY	UNIT
•	•		All	1	frame
•		•	All	1	frame
•			QVGA	1	frame
•			Non-QVGA	0	frame

4.3.3 Temporal Synchronization

The SR300 client software can temporally synchronize the depth video frames with the color and video frames when both streams are set to the same frame rate or vary by an integer ratio. If infrared video is requested simultaneously with depth video, the SR300 hardware will temporally synchronized the two streams.

Table 4-7: Temporal Synchronization

COLOR	DEPTH	INFRARED	VARIABLE FPS	TIMESTAMP DELTA	UNIT
•	•		YES	≤ 1	ms
	•	•	NO	0	ms

The effective frame rates for color and depth synced video streams can decrease for continuous mismatches in timestamps greater than 1 millisecond. It is recommended that color auto-exposure be disabled when synchronization is enabled.

4.4 Depth Field of View (FOV)

Table 4-8. Depth Field of View

Format	SR300/SR305
Horizontal FOV (deg)	69±3
Vertical FOV (deg)	54±2

4.5 Measured Power

Table 4-9. Power- Ubuntu 16.04

Model	Idle (W)	Normal Power (W) <i>Typical Usage Configuration</i>	Maximum Power (W) <i>Worst Case Configuration</i>
SR300/SR305	0.02	1.8	2.3

Table 4-10. Power – Windows 10 (RS4)

Model	Idle (W)	Normal Power (W) <i>Typical Usage Configuration</i>	Maximum Power (W) <i>Worst Case Configuration</i>
SR300/SR305	0.02	1.8	2.3

4.6 Depth Start Point (Ground Zero Reference)

The depth start point or the ground zero reference can be described as the starting point or plane where depth = 0. For depth modules (SR300), this point is referenced from front of lens. For depth cameras (SR305), this point is referenced from front of camera cover glass

Figure 4-1. Depth Module Depth Start Point Reference

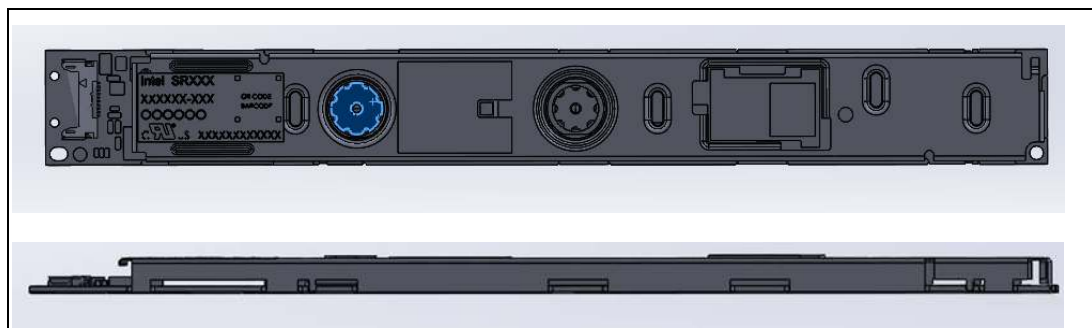

Table 4-11. Depth Module Depth Start Point

Depth Module	Front of Lens (Z')	Back of Module (Z'')
SR300	0.9mm	3.0mm

NOTES:

If depth measurement reference is front of lens, then |Z'| should be added to measured value to determine Ground Truth. If depth measurement reference is back of module, then |Z''| should be subtracted to determine Ground Truth.

Figure 4-2. Depth Camera Depth Start Point Reference

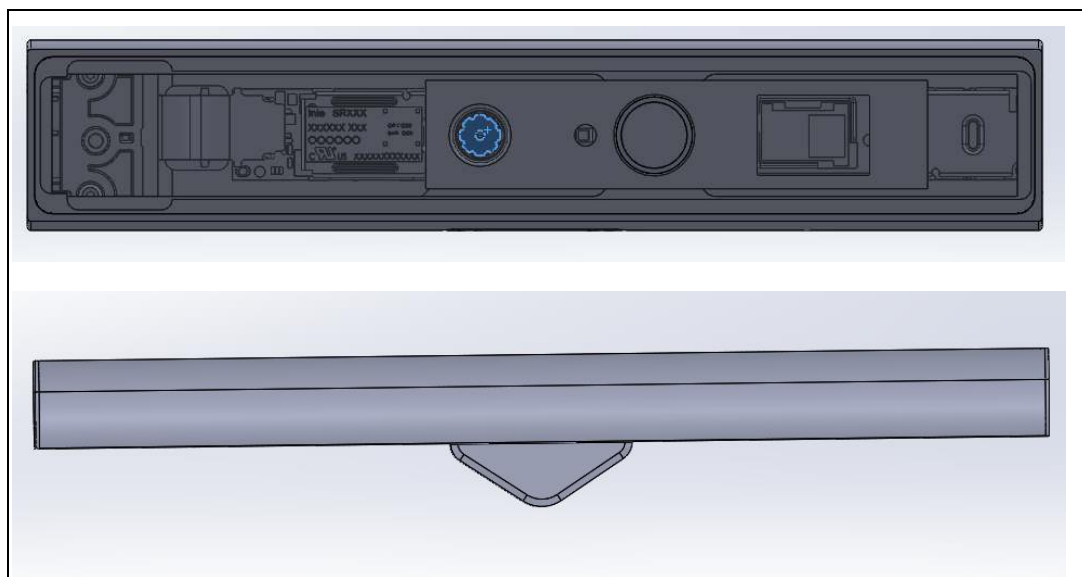

Table 4-12. Depth Cameras Depth Start Point

Depth Camera	Camera Front Cover (Z')	Camera Back (Z'')
SR305	3.4mm	7.6mm

NOTES:

If depth measurement reference is front cover glass, then |Z'| should be added to measured value to determine Ground Truth. If depth measurement reference is back of camera, then |Z''| should be subtracted to determine Ground Truth.

4.7 Depth Camera Functions

Camera exposes the following Depth image settings.

Table 4-13: Depth Properties

PROPERTY	DESCRIPTION	AUTO
DEPTH_PROJECTOR_POWER	Set the power output level of the projector.	•
DEPTH_ACCURACY	Set the number of patterns projected per frame.	
DEPTH_FILTER_OPTION	Set the filter to apply to each depth frame.	
DEPTH_MOTION_RANGE	Set the exposure time for each pattern.	•
DEPTH_CONFIDENCE	Set the threshold between valid and invalid values.	
DEPTH_PRESET	Set depth setting preset based on specific usage.	

Table 4-14: Depth Property Values

PROPERTY	VALUE RANGE	DEFAULT
DEPTH_PROJECTOR_POWER	0 - 16 (see projector settings)	16
DEPTH_ACCURACY ⁽¹⁾	1 (max) - 3 (min)	1
DEPTH_FILTER_OPTION	0 - 7 (see filter settings)	5
DEPTH_MOTION_RANGE ⁽²⁾	0 (motion) - 220 (range)	9
DEPTH_CONFIDENCE	0 (min) - 15 (max)	3
DEPTH_PRESET ⁽³⁾	0 - 9 (see preset settings)	N/A

(1) Accuracy values of 2 and 3 will produce the same result as both settings generate same number of patterns.

(2) When accuracy is set to 1 (max), each increase in MvR increments total depth frame exposure by approximately 1.0ms.

(3) No preset is enabled by default, start up is based on the default settings of the individual depth properties.

4.8 Color Camera Functions

Table 4-15: Standard Color Properties

PROPERTY	DESCRIPTION	AUTO
COLOR_EXPOSURE	Manual setting when auto exposure is disabled.	•
COLOR_BRIGHTNESS	Sets brightness when auto-exposure is enabled.	
COLOR_CONTRAST	Sets contrast based on the brightness of the scene.	
COLOR_SATURATION	Sets saturation adjustment applied to the frame.	
COLOR_HUE	Sets hue adjustment applied to the frame.	
COLOR_GAMMA	Sets gamma correction applied to the frame.	
COLOR_WHITE_BALANCE	Manual setting when auto white balance is disabled.	•
COLOR_SHARPNESS	Sets sharpening adjustment applied to the frame.	
COLOR_BACK_LIGHT_COMP	Sets weight amount based on scene brightness.	

COLOR_GAIN	Sets gain level when auto-exposure is disabled.	
------------	---	--

Table 4-16: Standard Color Property Values

PROPERTY	RANGE	DEFAULT
COLOR_EXPOSURE	-8 (min) – 0 (max)	AUTO
COLOR_BRIGHTNESS	0 (min) – 255 (max)	0
COLOR_CONTRAST	-0 (min) – 100 (max)	50
COLOR_SATURATION	0 (min) – 100 (max)	64
COLOR_HUE	-180 (min) – 180 (max)	0
COLOR_GAMMA	100 (min) – 500 (max)	300
COLOR_WHITE_BALANCE	2800 (min) – 6500 (max)	AUTO
COLOR_SHARPNESS	0 (min) – 100 (max)	50
COLOR_BACK_LIGHT_COMP	0 (min) – 4 (max)	0
COLOR_GAIN	0 (min) – 128 (max)	64

§§

5 Firmware

The firmware contains the operation instructions. Upon runtime, vision processor loads the firmware and programs the component registers. If the vision processor is configured for update or recovery, the unlocked R/W region of the firmware can be changed.

5.1 Update

During a firmware update, the firmware utility will issue a device firmware update command to the vision processor. The vision processor will then reset into firmware update mode. The firmware utility uses a single binary file to maintain the firmware image. The firmware utility compares the firmware version installed on the camera to the firmware version file to be updated. Based on the comparison, the firmware utility will downgrade, upgrade, or skip if the versions match.

5.1.1 Update Limits

The firmware update engine does not allow infinite update cycles between older and current versions of firmware. The engine will establish a baseline version of firmware based on the latest firmware version installed. The engine will allow a return to a previous version or baseline version of firmware up to 20 times. After the 20th update, the engine will only allow an update to a firmware revision higher than the baseline version.

5.2 Recovery

A read only boot sector is built into firmware which enables basic operation regardless of the integrity of the operation instructions region. This ensures the imaging system can function in the case of firmware not be written properly. When a firmware recovery is required, the firmware utility will communicate with the recovery driver to set the DFU pin low and reset the imaging system in recovery mode.

The firmware recovery sequence will be triggered by the firmware client utility. This client utility will communicate through ACPI _DSM to trigger the controllable interrupt (GPIO) at the appropriate times. The firmware recovery requires an ACPI _DSM interface to control the interrupt GPIO in configuring to firmware recovery state. The _DSM methods and BIOS use the Write to GPIO functions to set the controllable interrupt.

§ §

6 Software

6.1 Intel® RealSense™ Software Development Kit 2.0

Intel® RealSense™ SDK 2.0 is a cross-platform library for working with Intel® RealSense™ Depth Camera SR300 Series. It is open source and available on <https://github.com/IntelRealSense/librealsense>

The SDK at a minimum includes:

- **Intel® RealSense™ Viewer** - This application can be used view, record and playback depth streams, set camera configurations and other controls.
- **Depth Quality Tool** - This application can be used to test depth quality, including: distance to plane accuracy, Z accuracy, standard deviation of the Z accuracy and fill rate.
- **Debug Tools** - These command line tools gather data and generate logs to assist in debug of camera.
- **Code Examples** - Examples to demonstrate the use of SDK to include D400 Series camera code snippets into applications.
- **Wrappers** -Software wrappers supporting common programming languages and environments such as ROS, Python, Matlab, node.js, LabVIEW, OpenCV, PCL, .NET and more



7 System Integration

The small size of the SR300 provides system integrators flexibility to design into a wide range of products.

7.1 System Level Block Diagram

Figure 7-1. System Block Diagram

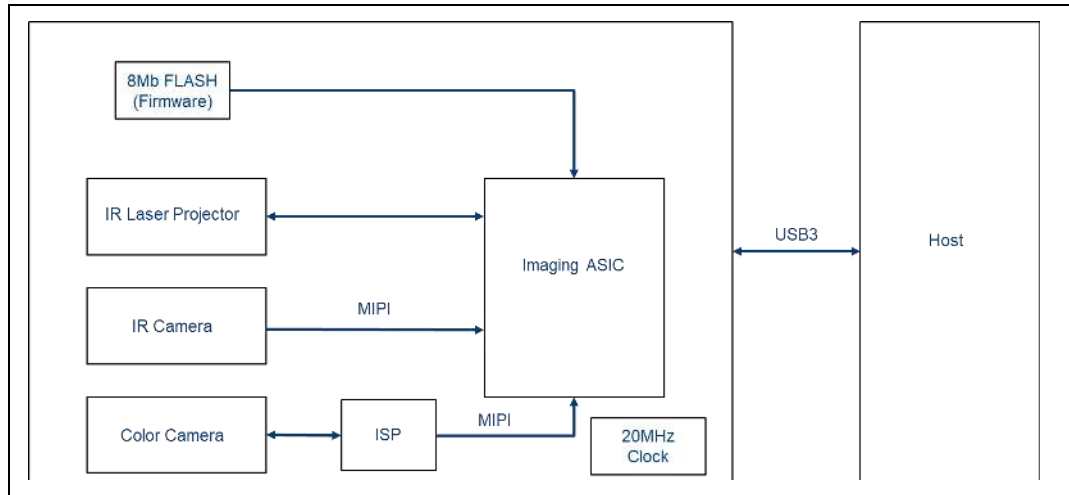

7.2 SR300 System Integration

7.2.1 SR300 Motherboard Connection

The motherboard connected method for the SR300 means that the module receptacle is connected to the host platform, requiring a receptacle on the motherboard that carries USB 3 signals.

Figure 7-2. SR300 Motherboard Connection (Illustration)

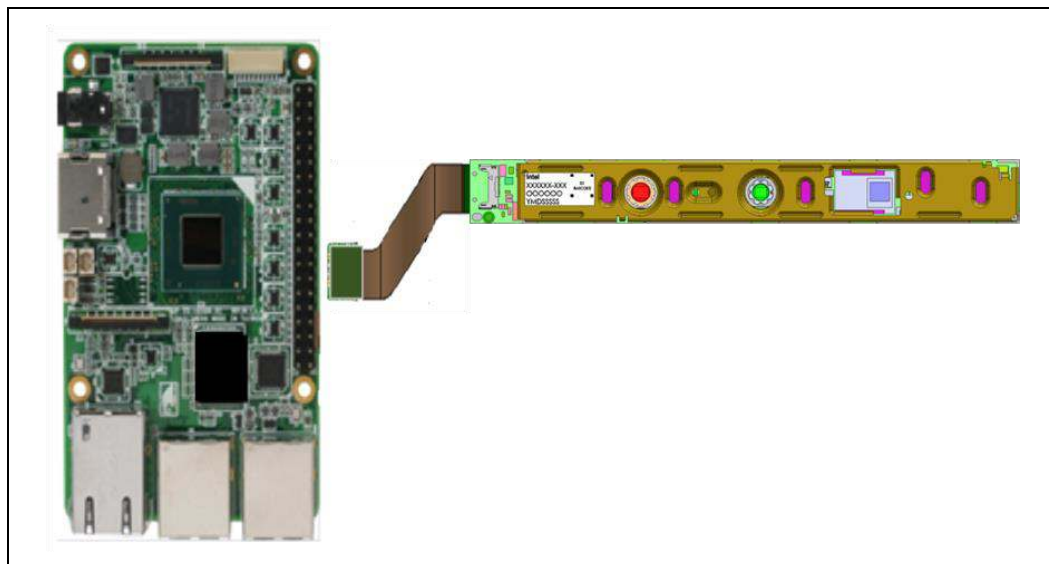

7.2.2 USB 3 Receptacle

Table 7-1. USB 3 Receptacle Characteristics

PROPERTY	DESCRIPTION	DIAGRAM
Shell Finish	Tin (Sn)	
Lock	Yes	
Ground Bar	Yes	
Alignment Boss	No	
Part Number	IPEX 20347-310E-12R	

Table 7-2. USB 3 Receptacle Pin Out

POSITION	NAME	TYPE	DESCRIPTION
1	GND	-	Ground
2	USB3_SS _{TX-}	OUT	USB 3.1 Gen 1 Transmitter Negative
3	USB3_SS _{TX+}	OUT	USB 3.1 Gen 1 Transmitter Positive
4	GND	-	Ground
5	USB3_SS _{RX-}	IN	USB 3.1 Gen 1 Receiver Negative
6	USB3_SS _{RX+}	IN	USB 3.1 Gen 1 Receiver Positive
7	GND	-	Ground
8	DFU/INT	IN	Device Firmware Update
9	5V	-	Supply Voltage, Connect to 5V

POSITION	NAME	TYPE	DESCRIPTION
10	5V	-	Supply Voltage, Connect to 5V

7.2.3 USB 3 High Speed Cable Assembly

The high speed cable assembly is developed and procured by the system integrator. The cable assembly design is specific to the system definition and must meet cable assembly design specification.

Table 7-3. USB 3 Plug Characteristics

PROPERTY	DESCRIPTION	DIAGRAM
Shell Finish	Tin (Sn)	
Friction Lock	Yes	
Ground Bar	Yes	
Plug Part Number	IPEX 2047-0103	
Housing Part Number	IPEX 20346-010T-31	

The cable should not be connected/disconnected from the SR300 more than 10 times.

Table 7-4. Cable Assembly Specification

PROPERTY	DESCRIPTION
Cable Length	508mm ± 10mm (~20 inches)
Controlled Impedance	50Ω ± 10%
Max Insertion Loss	7.5dB at 2.5Ghz
Cable Shielding	Each plug connected to the receptacle shield and GND bar.
Minimum Gauge	40 AWG for micro-coax, 36 AWG for wire.

Deviation from these properties is allowed, but the compatibility with the SR300 receptacle must be maintained. Longer cable lengths is allowed, but signal integrity should be evaluated by the system integrator.

7.2.4 Transmit to Receive Crossover

The host USB 3 transmit signals must be connected to the SR300 USB 3 receive signals. The host USB 3 receive signals must be connected to the SR300 USB 3 transmit signals. It is recommended not to cross over the signals in the cable to allow cable wiring to be flat and as thin as possible.

Table 7-5. Cable Assembly Interconnect Properties

POS	SR300	SYSTEM	AWG	INTERCONNECT DESCRIPTION
1	GND	GND	40	50Ω micro-coax, shield soldered to GND bar.
2	USB3_TXN	USB3_RXN	40	50Ω micro-coax, shield soldered to GND bar.
3	USB3_TXP	USB3_RXP	40	50Ω micro-coax, shield soldered to GND bar.
4	GND	GND	40	50Ω micro-coax, shield soldered to GND bar.
5	USB3_RXN	USB3_TXN	40	50Ω micro-coax, shield soldered to GND bar.
6	USB3_RXP	USB3_TXP	40	50Ω micro-coax, shield soldered to GND bar.
7	GND	GND	36	UL 10064 Wire (Rated at least 0.3A.)
8	INT	INT	36	UL 10064 Wire
9	VDD	5V	36	UL 10064 Wire (Rated at least 0.3A.)
10	VDD	5V	36	UL 10064 Wire (Rated at least 0.3A.)

7.2.5 Motherboard Receptacle

Table 7-6. Motherboard Receptacle Properties

PIN	WIRE DESCRIPTION
Differential Impedance	75 to 105Ω (USB3 Signals)
Rise Time	50ps (20% - 80%)
Max Cross Talk	-34dB up to 2.5GHz.
Current Rating	0.3A ± 5%
Shielding	Metal shielding, connected to GND plane.
Grounding	Two ground bar connections in addition to the connector GND.

Figure 7-3. Receptacle Ground Bar Motherboard Connections

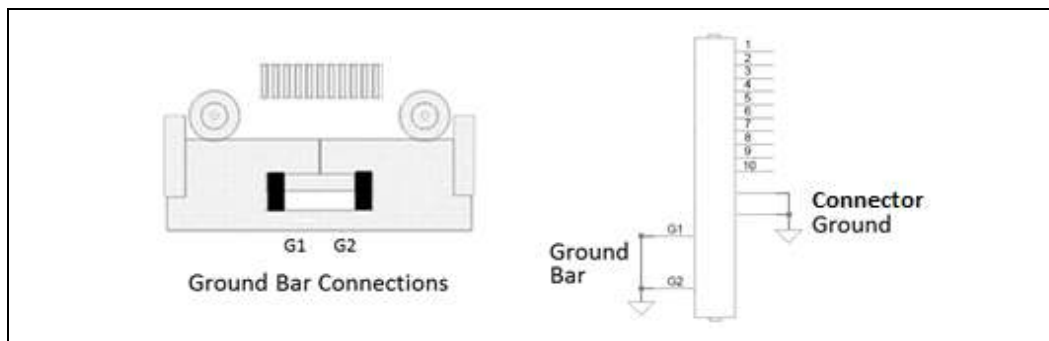

7.2.6 Power Requirements

The SR300 is powered by 5V from host motherboard through USB 3 receptacle pins 9 and 10

Table 7-7. SR300 Power Requirements

Parameter		Min	Nom	Max	Unit
VCC	Supply Voltage	+/-5%	5		V
ICC	Supply Current	N/A	600 ⁽¹⁾	N/A	mA

(1) The SR300 power resource should be capable of supplying at least 2.5W through a 5V nominal power source. The SR300 implements two 5V pins with a rated current of 0.3A for each pin.

7.3 Thermals

The system thermal design must ensure the component case temperature is not exceeded.

Table 7-8. Power and TDP at Max Operating Mode

Component	Power ⁽¹⁾	TDP ⁽²⁾	Unit
All Components	2300	2200	mW

(1) The values were measured with an ambient light of 200 Lux and with a white screen 20 cm in front of the camera filling the cameras FOV.
 (2) The IR projector and activity LED TDP is lower than power due to a percentage of energy dissipated as photonic emissions rather than heat.

Figure 7-4. Thermocouple Test Locations

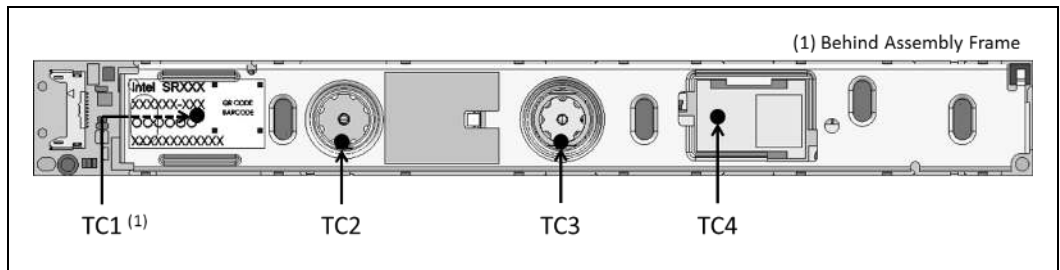

Table 7-9. Case Temperature Limits (Still Air)

LOCATION	COMPONENT	CASE TEMPERATURE LIMIT (T _{CASE})			UNIT
		MIN	TYPICAL ⁽¹⁾	MAX, 35°C T _A	
TC1	Vision Processor	0	N/A	85	°C
TC2	Infrared Camera	0	50	60 ⁽²⁾	°C
TC3	Color Camera	0	50	60 ⁽²⁾	°C

TC4	Infrared Projector	0	50	60 ⁽²⁾	°C
<p>(1) Typical represents the recommended TCcase temperature limit for standard runtime scenarios at 25°C TA (temperature ambient).</p> <p>(2) 60°C for the camera and projector components is worst case and must not be designed for typical operation. The camera sensor noise above the max temperature will exceed acceptable limits for image quality.</p>					

7.4 Module Mounting Guidance

7.4.1 Thermal Interface Material (TIM) Mount

It is recommended that either the 3M 8805 or 3M 9882 thermal-only conductive adhesive strip be used to attach the module to the system chassis. To maximize heat transfer, the TIM area should be maximized as much as possible to cover the area of the SR300 adhesive liner.

7.5 Passive Heat Spreader

To minimize the need or size for an internal passive heat spreader, it is recommended that a metal chassis material with a thermal conductance greater than 20 [W/mK] and an effective thermal resistance of less than 8 [K/W] be used. If a plastic chassis material is used, this will generally require a passive heat spreader solution.

Figure 7-5: Passive Heat Spreader

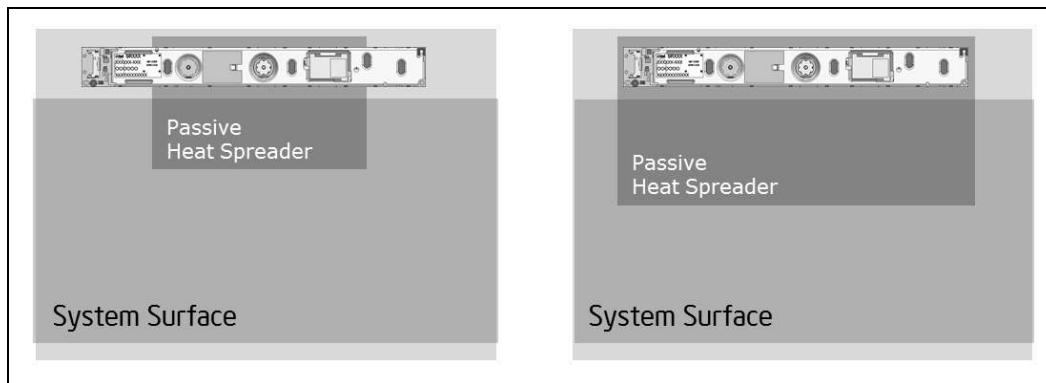

7.6 Attachment and Alignment

The SR300 aligns to the system chassis by two $1.4 \pm 0.05\text{mm}$ alignment pins separated by $107.4 \pm 0.1\text{mm}$. The SR300 consists of two corresponding alignment holes to ensure the subassembly cannot rotate after being assembled into the system.

Figure 7-6: Attachment Area and Alignment Pins

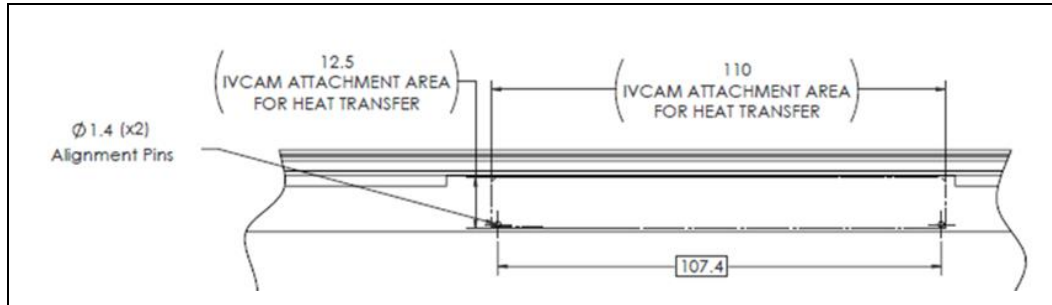



One alignment hole is a $1.5 \pm 0.05\text{mm}$ round for securing placement and one hole is a $1.5 \pm 0.05\text{mm}$ oval for accommodating manufacturing tolerances.

7.7 Through-Holes, Cover Design and Material Guidance

The system design through-holes should be designed to accommodate the maximum component field of view tolerances. The sensor field of view specifications are defined for the cameras and should be used for the through-hole evaluation.

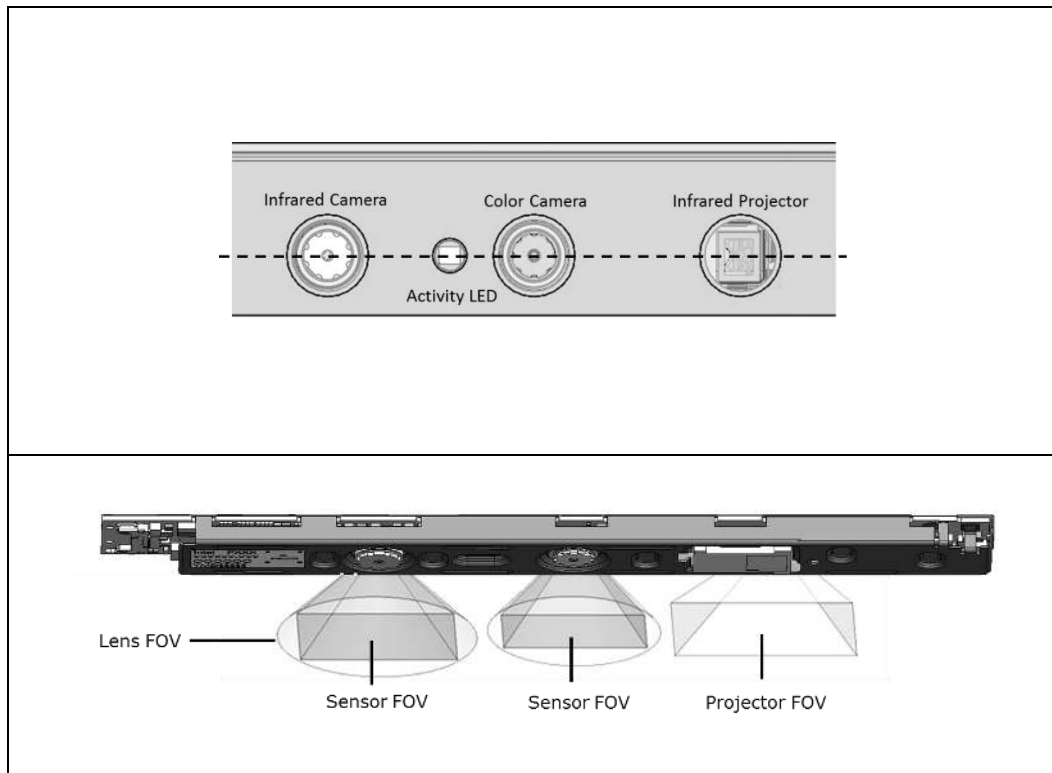
Figure 7-7: Through-Hole Design Considerations



 A system CAD evaluation should be completed with the SR300 CAD to validate that the dimensions of the system through-holes are sized to not intersect the sensor and projector FOV parts.

7.7.1 Cover Material Transmission

The SR300 components must be covered to minimize dust and humidity. The cover material stack-up used must provide acceptable transmission based on the component wavelengths, intended usage, and expected image quality for the system.

Table 7-10: Component Transmission

Specification	Recommendation	Notes
Materials	Acrylic	IR Projector & IR Imager – Clarex NIR-75N RGB Imager – Clarex PMMA Clear
Flatness	0.05mm	Minimize Distortion
Distance From Highest Point on Module to Cover	2.5mm	
Thickness of Cover	1mm	
Coatings	AR inside and AS outside	Avoid Reflections – IR Projector & IR Imager Coating tuned for min reflection at 850nm Avoid Scratches
Transmission Wavelength Range	IR Pass Filter <ul style="list-style-type: none"> - 820 to 870nm @ 97% transmission rate – AOI 0° - 820 to 870 @ 95% transmission rate – AOI 10° - 45° RGB – Visible Pass Filter <ul style="list-style-type: none"> - 400 to 650nm @ 97% transmission rate – AOI 0° - 400 to 650nm @ 95% transmission rate – AOI 10° - 45° 	
Cover Tilt Tolerance	± 0.5°	

 Transparent layers covering the laser projector and infrared sensor must have a uniform thickness and no perceivable curving or bending to minimize the distortion of the transmitted and reflected patterns.

7.8 Gaskets

Gaskets are recommended for providing optical isolation and dust protection. However, gaskets can impede FOV and place unwanted stress on the module or the individual sensor lens.

7.8.1 Dust Protection

Dust particles can accumulate over the camera lenses which can be visually unappealing and degrade image quality.

7.8.2 Acoustics

System elements in contact with the SR300 can cause acoustics generated by the SR300 to be transferred and amplified. To minimize this effect, the following considerations are recommended.

- The only chassis contact with the module is the adhesive liner to the adhesive TIM and SR300 alignment holes to the chassis alignment pins.
- Any chassis element around the module (metal/plastic), or any gaskets from the glass/bezel should be spaced at least 50-300um from the module.
- Avoid any hard connection between the camera module assembly frame and the chassis (plastic frame/glass).
- Maintain a minimum air-gap of 50-300um.



Acoustic measurements should be taken with SR300 integrated into the system. Measurements are not intended to be taken with respect to standalone module.

7.9 Grounding

Testing should be performed to quantify the level of grounding required. It is recommended that there be at least two ground contact points to the system.

- It is not recommended that the adhesive liner be used as primary grounding to avoid accidentally grounding the test points.
- The assembly frame can be used as the primary ground contact point to the system.
- Openings at the system for each of the SR300 components should be as small as possible.

Figure 7-8: No Ground or Electrical Contact

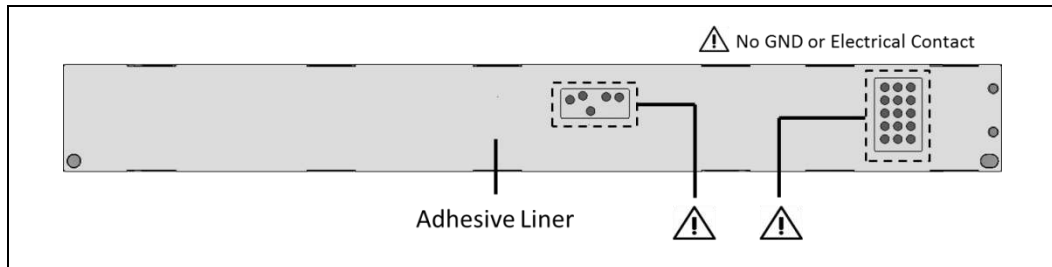

 Placement and assembly of any EMI gaskets on the assembly frame must not cause SR300 camera component occlusions. Grounding material must not make contact with any non-GND subassembly components, pads, or signals.

7.10 Firmware Recovery

To support firmware recovery, a 3.3V controllable interrupt must be connected to the DFU (Device Firmware Update) pin

Figure 7-9. Firmware Recovery Sequence

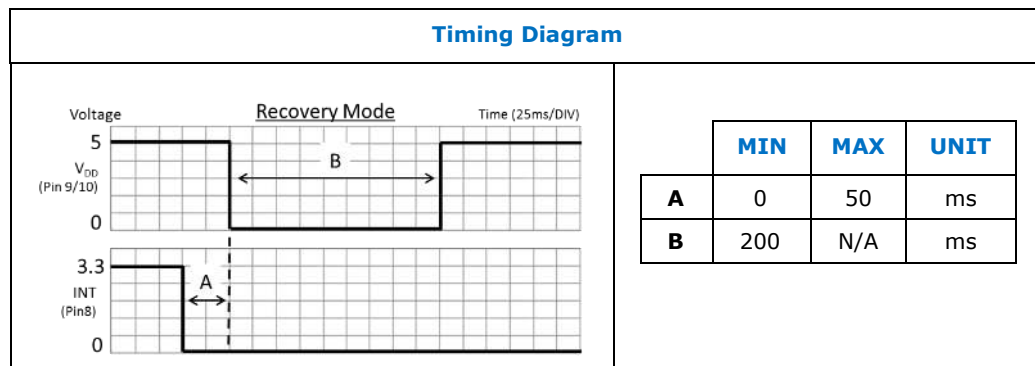

7.11 Infrared Projector Interference

Interference can occur if SR300/SR305 is capturing infrared patterns projected from multiple infrared projectors simultaneously. Low interference assumes a user is in front of each SR300/SR305 and comfortably spaced apart.

Figure 7-10: Interference

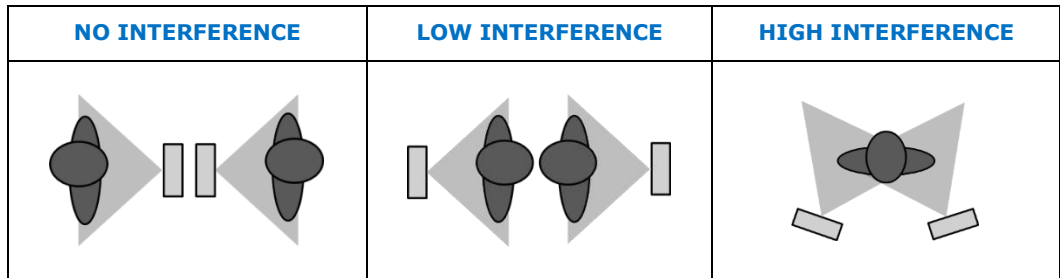

7.12 Handling Conditions

Table 7-11. Electrostatic Discharge Caution

	<p>To provide a consistent ESD protection level during SR300 system assembly and rework, it is recommended that the JEDEC JESD625-A requirements standard be incorporated into the ESD environment controls.</p>
---	--

§ §

8 Regulatory Compliance

8.1 System Laser Compliance

The Intel® RealSense™ Depth Camera SR300 series certification is transferable to the system. However, the following statements and labels must be included in the user manual of the end product.

8.1.1 Certification Statement

This product is classified as a Class 1 Laser Product under the EN/IEC 60825-1, Edition 3 (2014) internationally and IEC60825-1, Edition 2 (2007) in the US.

This product complies with US FDA performance standards under 21 CFR 1040.10 for laser products except for deviations pursuant to Laser Notice No. 50 dated June 24, 2007.

8.1.2 Explanatory Label

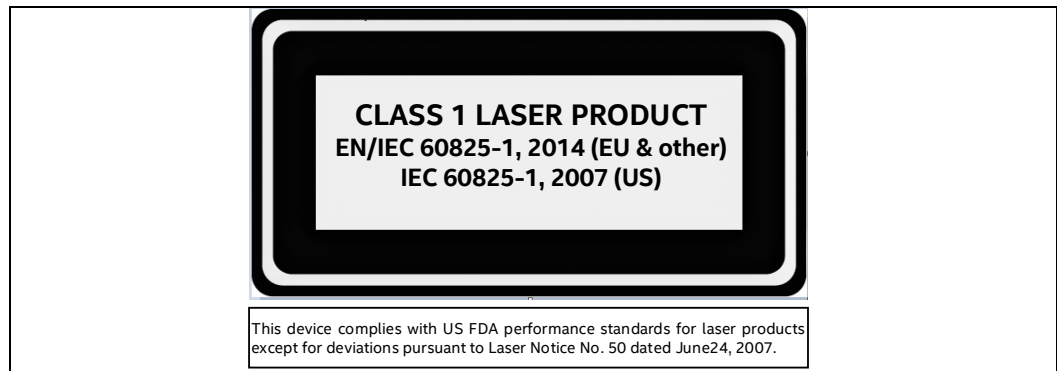

8.1.3 Cautionary Statements

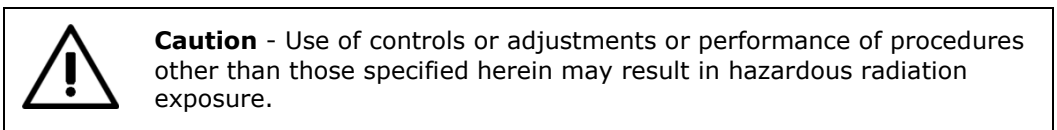
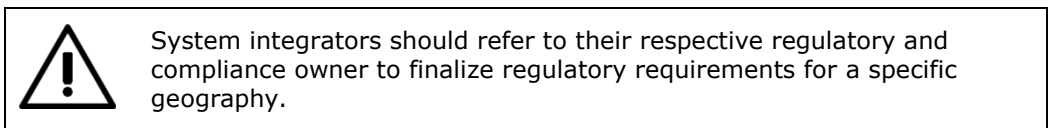



- Do not power on the product if any external damage was observed.
- There are no service/maintenance, modification, or disassembly procedures for SR300 series and infrared projector. The system integrator must either notify Intel or return modules before any failure analysis is performed.
- Do not attempt to open any portion of this laser product.
- Invisible laser radiation when opened. Avoid direct exposure to beam.
- There are no user serviceable parts with this laser product.
- Modification or service of the SR300 series, specifically the infrared projector, may cause the emissions to exceed Class 1.
- Do not try to update camera firmware that is not officially released for specific camera module SKU and revision.

8.1.4 Manufacturer’s Information

Manufactured by Intel Corporation
Attn: Corp. Quality
2200 Mission College Blvd., Santa Clara, CA 95054

EU Single Place of Contact:
Att. Corp Quality
Intel Deutschland GmbH
Am Campeon 10-12
Neubiberg, 85579 – Germany

8.1.5 US FDA Accession Number

U.S. FDA accession number is **1420377**.

This accession number should be entered into Box B.1 of the Food and Drug Administration (FDA) 2877 Declaration for Imported Electronic Products Subject to Radiation Control standards.

8.1.6 NRTL Statement

For the US and Canada market, this product has been tested and certified by UL and found to be compliant with all applicable requirements of the specifications below.

UL 60950-1 2nd Edition, CAN/CSA C22.2 No. 60950-1-07, Information Technology Equipment – Safety – Part 1: General Requirements

UL is a Nationally Recognized Testing Laboratory (NRTL), recognized by US Occupational Safety and Health Administration (OSHA) as qualified to perform safety testing and certifications covered within its scope of recognition.



www.ul.com/database

NWGQ2.E139761

NWGQ8.E139761

8.2 Ecology Compliance

8.2.1 China RoHS Declaration

China RoHS Declaration

产品中有毒有害物质的名称及含量Hazardous
Substances Table

部件名称 Component Name	有毒有害物质或元素 Hazardous Substance					
	铅 Pb	汞 Hg	镉 Cd	六价铬 Cr (VI)	多溴联苯 PBB	多溴二苯醚 PBDE
相机 Camera	X	○	○	○	○	○
印刷电路板组件 Printed Board Assemblies	X	○	○	○	○	○
电缆 Cable	○	○	○	○	○	○
<p>○：表示该有毒有害物质在该部件所有均质材料中的含量均在 GB/T 26572 标准规定的限量要求以下。 ○：Indicates that this hazardous substance contained in all homogeneous materials of such component is within the limits specified in GB/T 26572.</p> <p>×：表示该有毒有害物质至少在该部件的某一均质材料中的含量超出 GB/T 26572 标准规定的限量要求。 ×：Indicates that the content of such hazardous substance in at least a homogeneous material of such component exceeds the limits specified in GB/T 26572.</p> <p>对销售之日的所售产品, 本表显示我公司供应链的电子信息产品可能包含这些物质。注意：在所售产品中可能会也可能不会含有所有所列的部件。 This table shows where these substances may be found in the supply chain of our electronic information products, as of the date of sale of the enclosed product. Note that some of the component types listed above may or may not be a part of the enclosed product.</p>						

除非另外特别的标注, 此标志为针对所涉及产品的环保使用期限标志. 某些可更换的零部件可能会有一个不同的环保使用期限 (例如 电池单元模块).



用于产品在产品手册中所规定的条件下工作.

The Environment-Friendly Use Period (EFUP) for all enclosed products and their parts are per the symbol shown here, unless otherwise marked. Certain field-replaceable parts may have a different EFUP (for example, battery modules) number. The Environment-Friendly Use Period is valid only when the product is operated under the conditions defined in the product manual.

8.2.2 EU RoHS Declaration

This device is EU RoHS 2 (Directive 2011/65/EU) compliant and low halogen (PCB). For additional details please download the [SR300 Material Declaration Data Sheet](#).

8.2.3 Waste Electrical and Electronic Equipment



“In the EU, this symbol means that this product must not be disposed of with household waste. It is your responsibility to bring it to a designated collection point for the recycling of waste electrical and electronic equipment. For more information, contact the local waste collection center or your point of purchase of this product.”

8.3 USB Certification Compliance

The Intel(R) RealSense(TM) Depth Camera SR300 series, has passed the USB-IF Test Procedure for USB 3.1 Gen 1 products.



<http://www.usb.org/kcompliance/view/>
TID: 310000184



9 Mechanical Drawings

Figure 9-1. Intel® RealSense™ Depth Module SR300

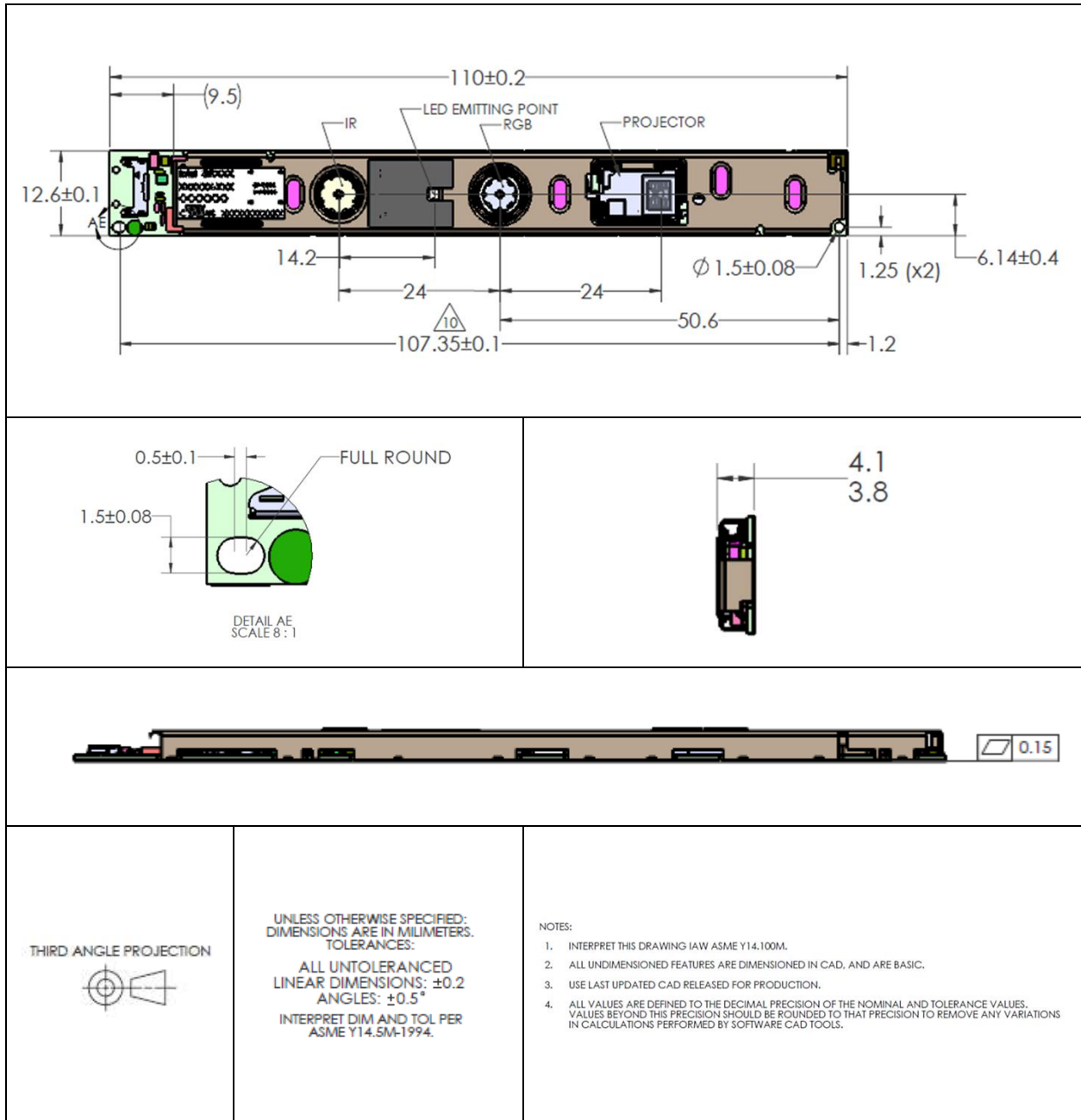
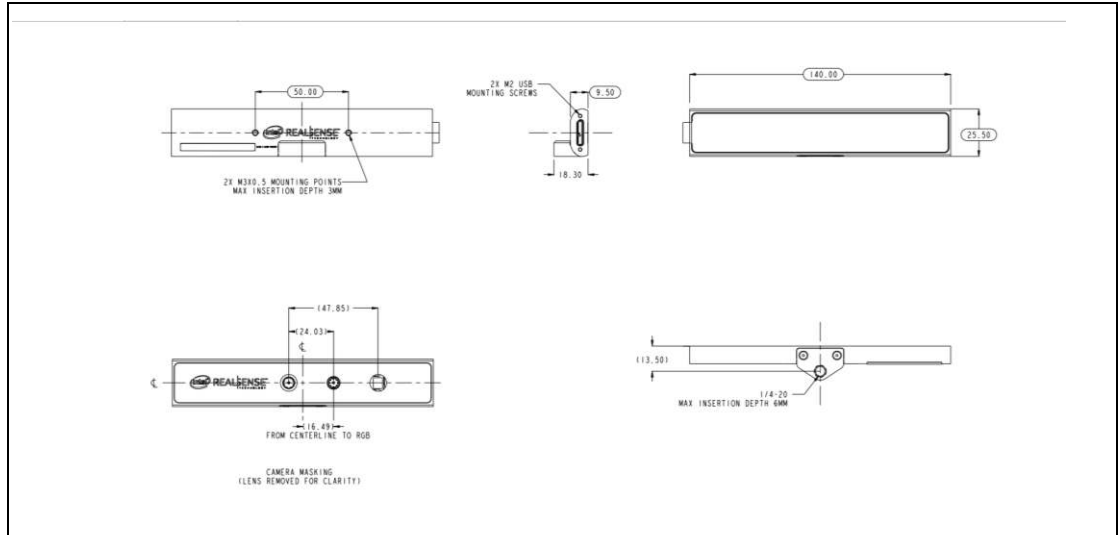

Figure 9-2. Intel® RealSense™ Depth Camera SR305



SS

10 Appendix A – SR300 Schematic Checklist

The following checklist should be compared to the motherboard design.

Table 10-1: Motherboard Connector Signals

CONNECTOR	MOTHERBOARD	REQUIRED	√
Pin 1	Routed to GND	Y	
Pin 2	Routed to USB3_RXN	Y	
Pin 3	Routed to USB3_RXP	Y	
Pin 4	Routed to GND	Y	
Pin 5	Routed to USB3_TXN	Y	
Pin 6	Routed to USB3_TXP	Y	
Pin 7	Routed to GND	Y	
Pin 8	Routed to RECOVERY 3.3V GPIO	Y	
Pin 9	Routed to 5V Supply	Y	
Pin 10	Routed to 5V Supply	Y	
Connector	Routed to GND	Y	
Connector	Routed to GND	Y	
Ground Bar	Routed to GND	Y	
Ground Bar	Routed to GND	Y	

Table 10-2: USB_RX Motherboard Signals

SIGNAL	MOTHERBOARD	REQUIRED	√
Pin 2	ESD protection diode connected to GND.	Optional	
Pin 3	ESD protection diode connected to GND.	Optional	

Table 10-3: USB_TX Motherboard Signals

SIGNAL	MOTHERBOARD	REQUIRED	√
Pin 5	Inline 80ohm choke placed close to connector.	Y	
Pin 5	Inline 0.1uF AC capacitor placed close to the connector.	Y	
Pin 5	ESD protection diode connected to GND.	Optional	
Pin 6	Inline 80ohm choke placed closed to connector.	Y	
Pin 6	Inline 0.1uF AC capacitor placed close to the connector.	Y	
Pin 6	ESD protection diode connected to GND.	Optional	

Table 10-4: Power Signals

SIGNAL	MOTHERBOARD	REQUIRED	✓
Pin 9/10	Series components rated for at least 1A.	Y	
Pin 9/10	Independent 5V controllable FET	Y	
Pin 9/10	Routed 5V FET control GPIO	Y	

§ §

11 Appendix B – SR300 Cable Drawings

The interconnect cable can be used to connect the SR300 to the motherboard receptacle or to the receptacle on the USB adapter card.

Table 11-1: Cable Ordering Logistics

VENDOR	PART NUMBER	LENGTH	REVISION	SALES CONTACT
Amphenol	H26311-001	100mm	AX1	Bruce Motavaf AGIS - Sales Engineer Amphenol bruce.motavaf@amphenol-gis.com 408.799.6060
Amphenol	H26312-001	150mm	AX1	
Amphenol	H26313-001	300mm	AX1	
Amphenol	H26314-001	500mm	AX1	

Figure 11-1: Cable Mechanical Drawing

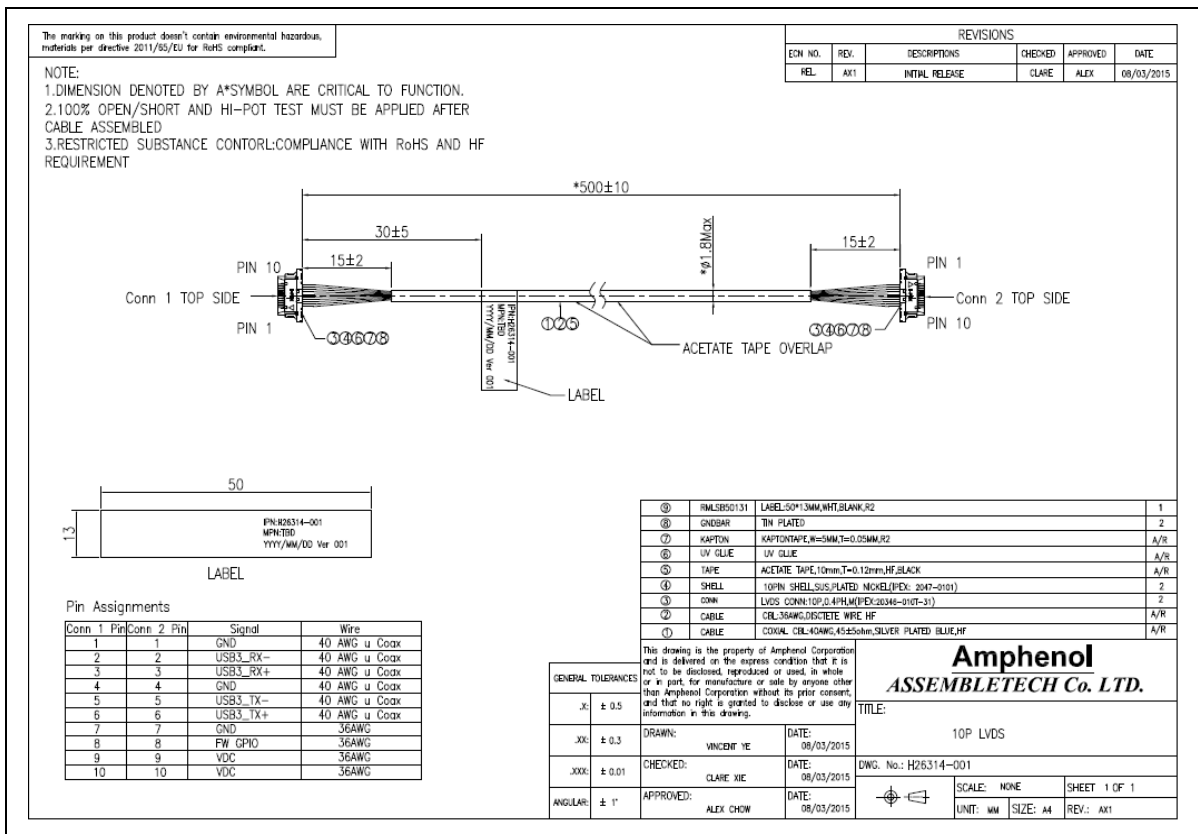

§ §

12 Appendix C - SR300 USB Adapter

The SR300 is designed to be integrated into a client system as a subassembly component through an internal interconnecting cable. If a system configuration requires the SR300 to be connected through a standard USB connection, an adapter is required to convert the SR300 receptacle connection to a standard USB plug.

Figure 12-1: SR300 Adapter 3D

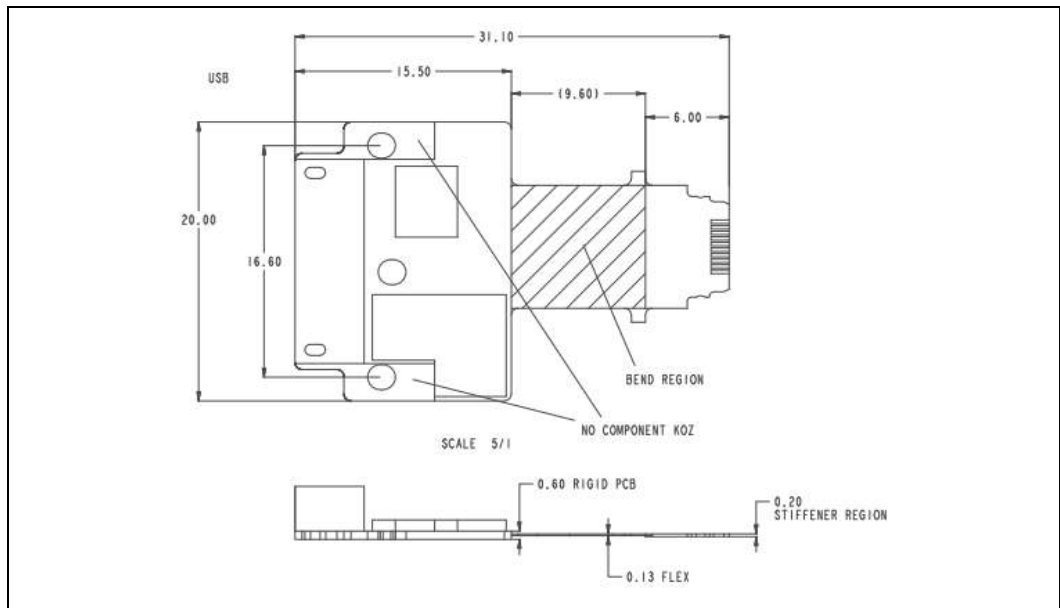



Table 12-1: Mechanical Dimensions

DIMENSION	NOMINAL	UNIT
Width	32.1 ⁽¹⁾	mm
Height	20 ⁽²⁾	mm
Depth	5.3 ⁽³⁾	mm

(1) Measured from USB micro-B receptacle edge to PCB tail edge.
 (2) Measured from PCB edge to PCB edge (parallel to USB).
 (3) Measured from PCB bottom to top of USB (tallest component).

Intel provides an adapter design schematic for reference purposes only. This adapter board design converts the SR300 receptacle connection to a standard USB3 micro-B receptacle on a single subassembly. A 10 pin cable with an SR300 plug on either end is required to connect the SR300 to this adapter board. A standard USB3 micro-B to USB3 type-A cable is required to connect the adapter board to a standard USB3 external port.

 The USB test adapter design is for reference purposes only. Intel disclaims all express and implied warranties, including without limitation, the implied warranties of merchantability, fitness for a particular purpose, and non-infringement, as well as any warranty arising from course of performance, course of dealing, or usage in trade.

12.1 Design Reference

Figure 12-2: SR300 Adapter 2D

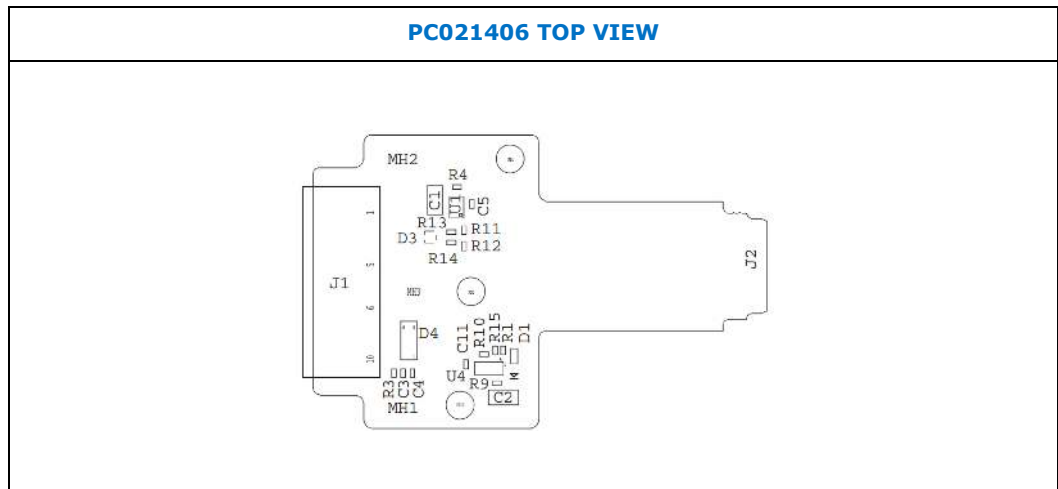
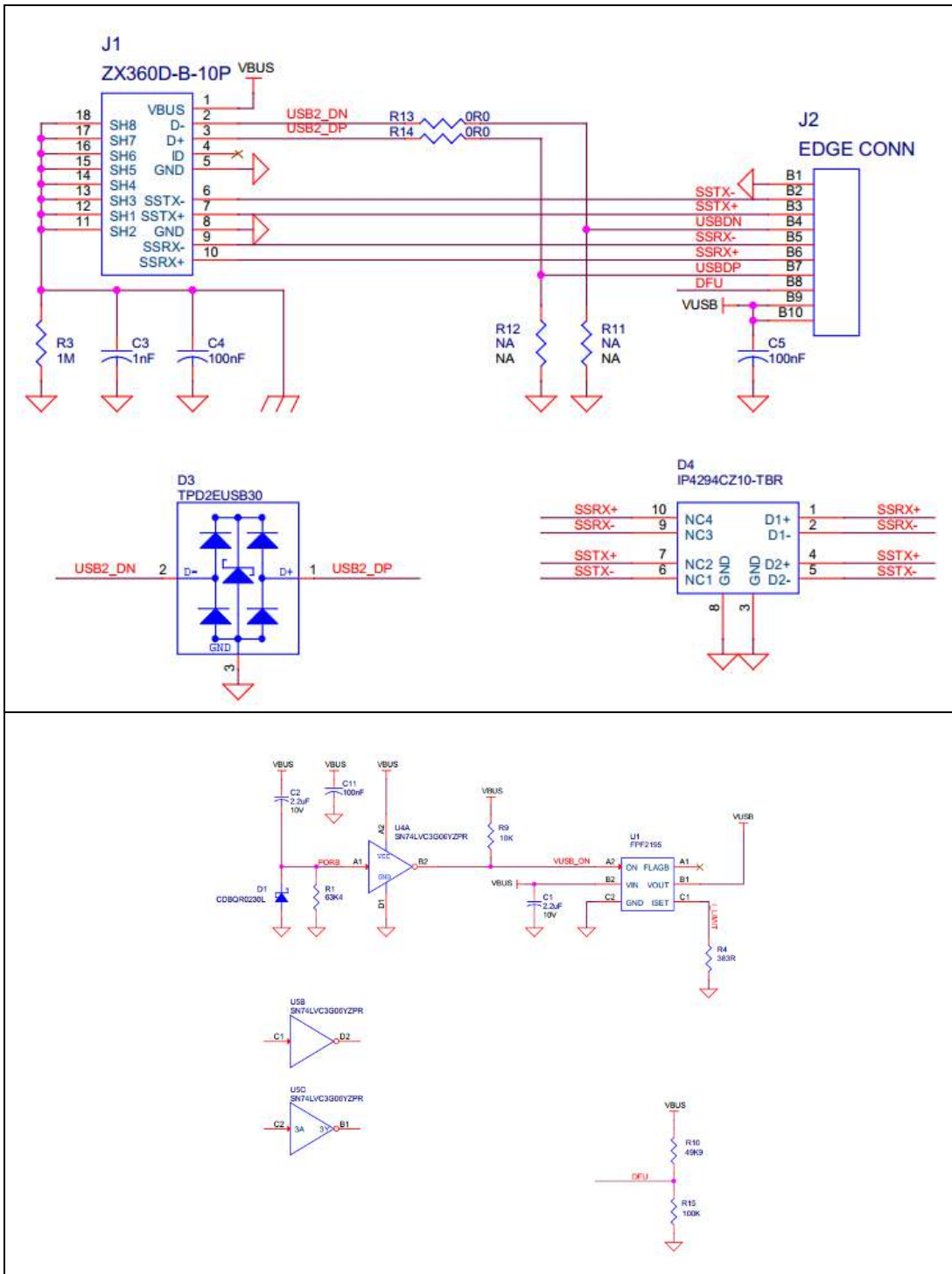

Table 12-2: USB Interposer Designator Description

DESIGNATOR	DESCRIPTION
J1	Receptacle for USB3 micro-B cable connection
J2	Tab for SR300 connector
D4	ESD Diode Pack

Figure 12-3: SR300 USB Interposer Schematics



X-ON Electronics

Largest Supplier of Electrical and Electronic Components

Click to view similar products for [Sockets & Adapters](#) category:

Click to view products by [Intel](#) manufacturer:

Other Similar products are found below :

[6508-0-00-01-00-00-33-0](#) [AC164348](#) [1262](#) [22827](#) [AC164353](#) [TDGL015](#) [SA247](#) [SM64TQ-ACTEL-1](#) [70-0036](#) [8.06.03](#) [DS91230+](#) [SMPA-ISP-ACTEL-3-KIT](#) [16017](#) [LFVDBGF](#) [KIT 70601-3](#) [SM132CQ-ACTEL](#) [R0E000010ACB20](#) [IPC0181](#) [IPC0175](#) [IPC0165](#) [AC164397](#) [conga-Thin MITX/eDP to DP Adapter](#) [SLG46621V-SKT](#) [SLG46722V-SKT](#) [ML-ADP-EVN](#) [TOOLSTICK990MPP](#) [110-83-320-41-605101](#) [110-83-632-41-605101](#) [110-83-640-41-605101](#) [110-83-628-41-605101](#) [116-83-306-41-001101](#) [PA0003](#) [PA0007](#) [PA0009](#) [PA0035](#) [PA0085](#) [PA0096](#) [IPC0079](#) [ATARD-DBGADPT](#) [80-000286](#) [ATSTK600-RC88](#) [ATSTK600-SC06](#) [ATSTK600-RC78](#) [SPC560PADPT64S](#) [AC164345](#) [AC164342](#) [AC164038](#) [14-351000-11-RC](#) [966927-1](#) [116-87-308-41-003101](#)