

Intel[®] Xeon[®] and Intel[®] Core[™] Processors For Communications Infrastructure

Datasheet - Volume 1 of 2

Supporting:

Intel[®] Xeon[®] Processor E3-1125C

Intel[®] Xeon[®] Processor E3-1105C

Intel[®] Core[™] i3 Processor 2115C

Intel[®] Pentium[®] Processor B915C

Intel[®] Celeron[®] Processor 725C

Document #324803 - 2nd Generation Intel[®] Core[™] Processor Family Mobile Datasheet - Volume 2 completes the documentation set and contains additional product information.

May 2012



INFORMATION IN THIS DOCUMENT IS PROVIDED IN CONNECTION WITH INTEL PRODUCTS. NO LICENSE, EXPRESS OR IMPLIED, BY ESTOPPEL OR OTHERWISE, TO ANY INTELLECTUAL PROPERTY RIGHTS IS GRANTED BY THIS DOCUMENT. EXCEPT AS PROVIDED IN INTEL'S TERMS AND CONDITIONS OF SALE FOR SUCH PRODUCTS, INTEL ASSUMES NO LIABILITY WHATSOEVER AND INTEL DISCLAIMS ANY EXPRESS OR IMPLIED WARRANTY, RELATING TO SALE AND/OR USE OF INTEL PRODUCTS INCLUDING LIABILITY OR WARRANTIES RELATING TO FITNESS FOR A PARTICULAR PURPOSE, MERCHANTABILITY, OR INFRINGEMENT OF ANY PATENT, COPYRIGHT OR OTHER INTELLECTUAL PROPERTY RIGHT.

A "Mission Critical Application" is any application in which failure of the Intel Product could result, directly or indirectly, in personal injury or death. SHOULD YOU PURCHASE OR USE INTEL'S PRODUCTS FOR ANY SUCH MISSION CRITICAL APPLICATION, YOU SHALL INDEMNIFY AND HOLD INTEL AND ITS SUBSIDIARIES, SUBCONTRACTORS AND AFFILIATES, AND THE DIRECTORS, OFFICERS, AND EMPLOYEES OF EACH, HARMLESS AGAINST ALL CLAIMS COSTS, DAMAGES, AND EXPENSES AND REASONABLE ATTORNEYS' FEES ARISING OUT OF, DIRECTLY OR INDIRECTLY, ANY CLAIM OF PRODUCT LIABILITY, PERSONAL INJURY, OR DEATH ARISING IN ANY WAY OUT OF SUCH MISSION CRITICAL APPLICATION, WHETHER OR NOT INTEL OR ITS SUBCONTRACTOR WAS NEGLIGENT IN THE DESIGN, MANUFACTURE, OR WARNING OF THE INTEL PRODUCT OR ANY OF ITS PARTS.

Intel may make changes to specifications and product descriptions at any time, without notice. Designers must not rely on the absence or characteristics of any features or instructions marked "reserved" or "undefined." Intel reserves these for future definition and shall have no responsibility whatsoever for conflicts or incompatibilities arising from future changes to them. The information here is subject to change without notice. Do not finalize a design with this information.

The products described in this document may contain design defects or errors known as errata which may cause the product to deviate from published specifications. Current characterized errata are available on request.

Contact your local Intel sales office or your distributor to obtain the latest specifications and before placing your product order.

Copies of documents which have an order number and are referenced in this document, or other Intel literature, may be obtained by calling 1-800-548-4725, or go to: http://www.intel.com/#/en_US_01

Intel processor numbers are not a measure of performance. Processor numbers differentiate features within each processor family, not across different processor families. Go to: <http://www.intel.com/products/processor%5Fnumber/>

BunnyPeople, Celeron, Celeron Inside, Centrino, Centrino Inside, Cilk, Core Inside, i960, Intel, the Intel logo, Intel AppUp, Intel Atom, Intel Atom Inside, Intel Core, Intel Inside, Intel Insider, the Intel Inside logo, Intel NetBurst, Intel NetMerge, Intel NetStructure, Intel SingleDriver, Intel SpeedStep, Intel Sponsors of Tomorrow., the Intel Sponsors of Tomorrow. logo, Intel StrataFlash, Intel vPro, Intel XScale, InTru, the InTru logo, the InTru Inside logo, InTru soundmark, Itanium, Itanium Inside, MCS, MMX, Moblin, Pentium, Pentium Inside, Puma, skool, the skool logo, Sound Mark, The Creators Project, The Journey Inside, Thunderbolt, vPro Inside, VTune, Xeon, and Xeon Inside are trademarks of Intel Corporation in the U.S. and/or other countries.

*Other names and brands may be claimed as the property of others.

Copyright © 2012, Intel Corporation. All rights reserved.



Revision History

Date	Revision	Description
May 2012	001	Initial release



Contents

- 1.0 Introduction** 11
 - 1.1 Purpose / Scope / Audience..... 11
 - 1.2 Related Documents 11
 - 1.3 Terminology..... 13
- 2.0 Product Overview** 15
 - 2.1 Product Features 17
 - 2.2 Processor Details 17
 - 2.3 Supported Technologies..... 17
 - 2.4 Interface Features 17
 - 2.4.1 System Memory Support 17
 - 2.4.2 PCI Express*..... 18
 - 2.4.3 Direct Media Interface (DMI) 20
 - 2.4.4 Platform Environment Control Interface (PECI) 20
 - 2.5 Power Management Support..... 21
 - 2.5.1 Processor Core 21
 - 2.5.2 System 21
 - 2.5.3 Memory Controller 21
 - 2.5.4 PCI Express*..... 21
 - 2.5.5 DMI 21
 - 2.6 Thermal Management Support..... 21
 - 2.7 Package 21
 - 2.8 Testability..... 21
- 3.0 Interfaces** 23
 - 3.1 System Memory Interface 23
 - 3.1.1 System Memory Configurations Supported 23
 - 3.1.2 System Memory Timing Support 26
 - 3.1.3 System Memory Organization Modes 27
 - 3.1.4 Rules for Populating Memory Slots 28
 - 3.1.5 Technology Enhancements of Intel® Fast Memory Access (Intel® FMA) 28
 - 3.1.6 Data Scrambling..... 29
 - 3.1.7 DRAM Clock Generation 29
 - 3.2 PCI Express* Interface 29
 - 3.2.1 PCI Express* Architecture..... 30
 - 3.2.2 PCI Express* Configuration Mechanism..... 32
 - 3.2.3 PCI Express* Port Bifurcation 32
 - 3.2.4 PCI Express* Lanes Connection 34
 - 3.2.5 Configuring PCIe* Lanes..... 35
 - 3.2.6 Lane Reversal on PCIe* Interface..... 36
 - 3.3 Direct Media Interface 36
 - 3.3.1 DMI Error Flow 36
 - 3.3.2 Processor/PCH Compatibility Assumptions 36
 - 3.3.3 DMI Link Down..... 36
 - 3.4 Platform Environment Control Interface (PECI) 37
 - 3.5 Interface Clocking..... 37
 - 3.5.1 Internal Clocking Requirements 37
- 4.0 Technologies** 39
 - 4.1 Intel® Virtualization Technology 39
 - 4.1.1 Intel® VT-x Objectives 39
 - 4.1.2 Intel® VT-x Features..... 39
 - 4.1.3 Intel® VT-d Objectives 40



4.1.4	Intel® VT-d Features	40
4.1.5	Intel® VT-d Features Not Supported	41
4.2	Intel® Hyper-Threading Technology	41
4.3	Intel® Advanced Vector Extensions (Intel® AVX)	41
4.4	Intel® Advanced Encryption Standard New Instructions (Intel® AES-NI)	42
4.4.1	PCLMULQDQ Instruction	42
4.5	Intel® 64 Architecture x2APIC	42
5.0	Processor SKUs	45
5.1	Overview	45
5.1.1	SKU Features	45
6.0	Power Management	47
6.1	ACPI States Supported	48
6.1.1	System States	48
6.1.2	Processor Core/Package Idle States	48
6.1.3	Integrated Memory Controller States	48
6.1.4	PCIe* Link States	49
6.1.5	DMI States	49
6.1.6	Interface State Combinations	49
6.2	Processor Core Power Management	49
6.2.1	Enhanced Intel SpeedStep® Technology	50
6.2.2	Low-Power Idle States	50
6.2.3	Requesting Low-Power Idle States	51
6.2.4	Core C-states	52
6.2.5	Package C-States	53
6.3	IMC Power Management	57
6.3.1	Disabling Unused System Memory Outputs	57
6.3.2	DRAM Power Management and Initialization	57
6.4	PCIe* Power Management	59
6.5	DMI Power Management	59
6.6	Thermal Power Management	59
7.0	Thermal Management	61
7.1	Thermal Design Power (TDP) and Junction Temperature (TJ)	61
7.2	Thermal and Power Specifications	61
7.3	Thermal Management Features	63
7.3.1	Processor Package Thermal Features	63
7.3.2	Processor Core Specific Thermal Features	68
7.3.3	Memory Controller Specific Thermal Features	68
7.3.4	Platform Environment Control Interface (PECI)	69
8.0	Signal Description	71
8.1	System Memory Interface	71
8.2	Memory Reference and Compensation	74
8.3	Reset and Miscellaneous Signals	74
8.4	PCI Express* Based Interface Signals	75
8.5	DMI	75
8.6	PLL Signals	76
8.7	TAP Signals	76
8.8	Error and Thermal Protection	77
8.9	Power Sequencing	78
8.10	Processor Power and Ground Signals	78
8.11	Sense Pins	79
8.12	Future Compatibility	79
8.13	Processor Internal Pull Up/Pull Down	79



- 9.0 **Electrical Specifications** 81
 - 9.1 Power and Ground Pins..... 81
 - 9.2 Decoupling Guidelines 81
 - 9.2.1 Voltage Rail Decoupling 81
 - 9.3 Processor Clocking (BCLK, BCLK#) 82
 - 9.3.1 PLL Power Supply 82
 - 9.4 Serial Voltage Identification (SVID) 82
 - 9.5 System Agent (SA) Vcc VID 89
 - 9.6 Reserved or Unused Signals 90
 - 9.7 Signal Groups 90
 - 9.8 Test Access Port (TAP) Connection 92
 - 9.9 Storage Conditions Specifications 92
 - 9.10 DC Specifications 93
 - 9.10.1 Voltage and Current Specifications 94
 - 9.10.2 Platform Environmental Control Interface DC Specifications 99
 - 9.11 AC Specifications 101
 - 9.11.1 DDR3 AC Specifications 103
 - 9.11.2 PCI Express* AC Specification 107
 - 9.11.3 Miscellaneous AC Specifications 108
 - 9.11.4 TAP Signal Group AC Specifications 108
 - 9.11.5 SVID Signal Group AC Specifications 109
 - 9.12 Processor AC Timing Waveforms 109
 - 9.13 Signal Quality..... 114
 - 9.13.1 Input Reference Clock Signal Quality Specifications 115
 - 9.13.2 DDR3 Signal Quality Specifications 115
 - 9.13.3 I/O Signal Quality Specifications 115
 - 9.14 Overshoot/Undershoot Guidelines 115
 - 9.14.1 VCC Overshoot Specification 115
 - 9.14.2 Overshoot/Undershoot Magnitude 116
 - 9.14.3 Overshoot/Undershoot Pulse Duration 116
- 10.0 **Processor Ball and Package Information** 119
 - 10.1 Processor Ball Assignments 119
 - 10.2 Package Mechanical Information 146
- 11.0 **Processor Configuration Registers** 151
 - 11.1 ERRSTS - Error Status 152
 - 11.2 ERRCMD - Error Command..... 153
 - 11.3 SMICMD - SMI Command..... 154
 - 11.4 SCICMD - SCI Command 155
 - 11.5 ECCERRLOG0_C0 - ECC Error Log 0 155
 - 11.6 ECCERRLOG1_C0 - ECC Error Log 1 156
 - 11.7 ECCERRLOG0_C1 - ECC Error Log 0 157
 - 11.8 ECCERRLOG1_C1 - ECC Error Log 1 158
 - 11.9 MAD_DIMM_CH0 - Address Decode Channel 0 158
 - 11.10 MAD_DIMM_CH1 - Address Decode Channel 1 160
 - 11.11 Error Detection and Correction 161

Figures

- 2-1 Crystal Forest Platform Example Block Diagram 16
- 3-1 Intel® Flex Memory Technology Operation..... 28
- 3-2 PCI Express* Layering Diagram 30
- 3-3 Packet Flow through the Layers 31
- 3-4 PCI Express* Related Register Structures..... 32



3-5	PCI Express* PCI Port Bifurcation	33
3-6	PCIe* Typical Operation 16 Lanes Mapping	34
6-1	Power States	47
6-2	Idle Power Management Breakdown of the Processor Cores	50
6-3	Thread and Core C-State Entry and Exit	51
6-4	Package C-State Entry and Exit	55
7-1	Frequency and Voltage Ordering	64
9-1	Example of PECL Host-Client Connection	100
9-2	Input Device Hysteresis	101
9-3	Differential Clock – Differential Measurements	110
9-4	Differential Clock – Single Ended Measurements	111
9-5	DDR3 Command / Control and Clock Timing Waveform	111
9-6	DDR3 Receiver Eye Mask	112
9-7	DDR3 Clock to DQS Skew Timing Waveform	112
9-8	PCI Express* Receiver Eye Margins	113
9-9	TAP Valid Delay Timing Waveform	113
9-10	Test Reset (TRST#), Async Input, and PROCHOT# Timing Waveform	114
9-11	THERMTRIP# Power Down Sequence	114
9-12	VCC Overshoot Example Waveform	116
9-13	Maximum Acceptable Overshoot/Undershoot Waveform	117
10-1	Ball Map (Bottom View, Upper Left Side)	142
10-2	Ball Map (Bottom View, Upper Right Side)	143
10-3	Ball Map (Bottom View, Lower Left Side)	144
10-4	Ball Map (Bottom View, Lower Right Side)	145
10-5	Processor 4-Core Die Mechanical Package	147
10-6	Processor 2-Core Die / 1-Core Die Mechanical Package	148

Tables

1-1	Processor Documents	11
1-2	Cave Creek PCH Documents	12
1-3	Public Specifications	12
1-4	Terminology	13
3-1	Supported UDIMM Module Configurations ^{1, 2}	24
3-2	Supported SO-DIMM Module Configurations ^{1, 2}	25
3-3	Supported Memory Down Configurations 1	26
3-4	DDR3 System Memory Timing Support	27
3-5	Hardware Straps for PCIe* Controller Enabling (Port 1 Only)	35
3-6	Hardware Straps for Normal/Reversed Operation of PCIe* Lanes	36
3-7	Reference Clock	37
5-1	Base Features by SKU	45
6-1	System States	48
6-2	Processor Core/Package State Support	48
6-3	Integrated Memory Controller States	48
6-4	PCIe* Link States	49
6-5	DMI States	49
6-6	G, S and C State Combinations	49
6-7	Coordination of Thread Power States at the Core Level	51
6-8	P_LVLx to MWAIT Conversion	52
6-9	Coordination of Core Power States at the Package Level	54
7-1	TDP Specifications	62
7-2	Junction Temperature Specification	62
8-1	Signal Description Buffer Types	71
8-2	Memory Channel A	71
8-3	Memory Channel B	72

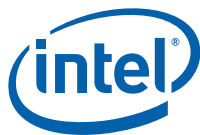

8-4	Memory Reference and Compensation	74
8-5	Reset and Miscellaneous Signals	74
8-6	PCI Express* Interface Signals	75
8-7	DMI - Processor to PCH Serial Interface	75
8-8	PLL Signals	76
8-9	TAP Signals.....	76
8-10	Error and Thermal Protection.....	77
8-11	Power Sequencing	78
8-12	Processor Power Signals	78
8-13	Sense Pins.....	79
8-14	Future Compatibility.....	79
8-15	Processor Internal Pull Up/Pull Down	79
9-1	IMVP7 Voltage Identification Definition	82
9-2	VCCSA_VID Configuration.....	89
9-3	Signal Groups	90
9-4	Storage Condition Ratings.....	93
9-5	Processor Core (VCC) DC Voltage and Current Specifications	94
9-6	Processor Uncore (VCCIO) Supply DC Voltage and Current Specifications	96
9-7	Memory Controller (VDDQ) Supply DC Voltage and Current Specifications	96
9-8	System Agent (VCCSA) Supply DC Voltage and Current Specifications	96
9-9	Processor PLL (VCCPLL) Supply DC Voltage and Current Specifications.....	97
9-10	DDR3 Signal Group DC Specifications	97
9-11	Control Sideband and TAP Signal Group DC Specifications	98
9-12	PCI Express* DC Specifications.....	99
9-13	PECI DC Electrical Limits.....	100
9-14	Differential Clocks (SSC on)	102
9-15	Differential Clocks (SSC off)	102
9-16	Processor Clock Jitter Specifications (cycle-cycle).....	102
9-17	System Reference Clock DC and AC Specifications.....	102
9-18	DDR3 Electrical Characteristics and AC Timings at 1066 MT/s, VDDQ = 1.5 V ±0.075 V.....	104
9-19	DDR3 Electrical Characteristics and AC Timings at 1333 MT/s, VDDQ = 1.5 V ±0.075 V.....	105
9-20	DDR3 Electrical Characteristics and AC Timings at 1600 MT/s, VDDQ = 1.5 V ±0.075 V.....	106
9-21	PCI Express* AC Specification	107
9-22	Miscellaneous AC Specifications	108
9-23	TAP Signal Group AC Specifications	108
9-24	SVID Signal Group AC Specifications	109
9-25	VCC Overshoot Specifications.....	115
9-26	Processor Overshoot/Undershoot Specifications	116
10-1	Alphabetical Ball Listing	120
10-2	Alphabetical Signal Listing.....	131
11-1	Register Terminology	151
11-2	Register Terminology Attribute Modifier	152
11-3	Error Status Register.....	152
11-4	Error Command Registers	154
11-5	SMI Command Registers.....	154
11-6	SCI Command Registers	155
11-7	Channel 0 ECC Error Log 0.....	156
11-8	Channel 0 ECC Error Log 1	157
11-9	Channel 1 ECC Error Log 0.....	157
11-10	Channel 1 ECC Error Log 1	158
11-11	Address Decode Channel 0.....	159
11-12	Address Decode Channel 1	160



11-13 Error Syndrome - ERRSYND 161

§ §





1.0 Introduction

1.1 Purpose / Scope / Audience

This document is to be used by Intel customers in place of the *2nd Generation Intel® Core™ Processor Family Mobile Datasheet - Volume 1 document #324803*.

This document contains the following processor information:

- DC and AC electrical specifications
- Differential signaling specifications
- Pinout and signal definitions
- Interface functional descriptions
- Additional product feature information
- Configuration registers pertinent to the implementation and operation of the processor on its respective platform.

For register details, see the latest version of the *2nd Generation Intel® Core™ Processor Family Mobile Datasheet – Volume 2*.

1.2 Related Documents

See the following documents for additional information.

Table 1-1. Processor Documents

Document	Document Number/ Location
<i>2nd Generation Intel® Core™ Processor Family Mobile Datasheet - Volume 2 of 2</i>	324803; http://www.intel.com/content/dam/doc/datasheet/2nd-gen-core-family-mobile-vol-2-datasheet.pdf
<i>Intel® Xeon® and Intel® Core™ Processors For Communications Infrastructure Thermal/Mechanical Design Guide</i>	327397; http://download.intel.com/embedded/processors/thermalguide/327397.pdf
<i>Intel® Xeon® and Intel® Core™ Processors For Communications Infrastructure Specification Update</i>	327335; http://download.intel.com/embedded/processor/specupdate/327335.pdf



Table 1-2. Public Specifications

Document	Document Number/ Location
<i>Advanced Configuration and Power Interface Specification 3.0</i>	http://www.acpi.info/
<i>PCI Local Bus Specification 3.0</i>	http://www.pcisig.com/specifications
<i>PCI Express Base Specification, Rev. 2.0</i>	http://www.pcisig.com
<i>DDR3 SDRAM Specification</i>	http://www.jedec.org
<i>DisplayPort Specification</i>	http://www.vesa.org
Intel® 64 and IA-32 Architectures Software Developer's Manuals: <ul style="list-style-type: none">• <i>Volume 1: Basic Architecture</i>• <i>Volume 2A: Instruction Set Reference, A-M</i>• <i>Volume 2B: Instruction Set Reference, N-Z</i>• <i>Volume 3A: System Programming Guide</i>• <i>Volume 3B: System Programming Guide</i>	http://www.intel.com/products/processor/manuals/index.htm <ul style="list-style-type: none">• 253665• 253666• 253667• 253668• 253669
<i>Intel® 64 and IA-32 Architectures Software Developer's Manual Documentation Changes</i>	http://www.intel.com/content/www/us/en/architecture-and-technology/64-ia-32-architectures-software-developers-manual.html
<i>Intel® Virtualization Technology Specification for Directed I/O Architecture Specification</i>	http://download.intel.com/technology/computing/vptech/Intel(r)_VT_for_Direct_IO.pdf



1.3 Terminology

Table 1-3. Terminology (Sheet 1 of 2)

Term	Description
DDR3	Third-generation Double Data Rate SDRAM memory technology
DMA	Direct Memory Access
DMI	Direct Media Interface
DTS	Digital Thermal Sensor
ECC	Error Correction Code
Enhanced Intel SpeedStep® Technology	Technology that provides power management capabilities to laptops.
Execute Disable Bit	The Execute Disable bit allows memory to be marked as executable or non-executable, when combined with a supporting operating system. If code attempts to run in non-executable memory the processor raises an error to the operating system. This feature can prevent some classes of viruses or worms that exploit buffer overrun vulnerabilities and can thus help improve the overall security of the system. See the <i>Intel® 64 and IA-32 Architectures Software Developer's Manuals</i> for more detailed information.
HFM	High Frequency Mode
IMC	Integrated Memory Controller
Intel® 64 Technology	64-bit memory extensions to the IA-32 architecture
Intel® TXT	Intel® Trusted Execution Technology is a versatile set of hardware extensions to Intel® processors and chipsets that enhance the digital office platform with security capabilities such as measured launch and protected execution. Intel® Trusted Execution Technology provides hardware-based mechanisms that help protect against software-based attacks and protects the confidentiality and integrity of data stored or created on the client PC.
Intel® VT-d	Intel® Virtualization Technology (Intel® VT) for Directed I/O. Intel® VT-d is a hardware assist, under system software (Virtual Machine Manager or OS) control, for enabling I/O device virtualization. Intel VT-d also brings robust security by providing protection from errant DMAs by using DMA remapping, a key feature of Intel VT-d.
Intel® Virtualization Technology	Processor virtualization which when used in conjunction with Virtual Machine Monitor software enables multiple, robust independent software environments inside a single platform.
IOV	I/O Virtualization
LFM	Low Frequency Mode
NCTF	Non-Critical to Function. NCTF locations are typically redundant ground or non-critical reserved, so the loss of the solder joint continuity at end of life conditions will not affect the overall product functionality.
Nehalem	Intel's 45-nm processor design, follow-on to the 45-nm Penryn design.
ODT	On-Die termination
PCH	Platform Controller Hub. The new, 2009 chipset with centralized platform capabilities including the main I/O interfaces along with power management, manageability, security and storage features.
PCLMULQDQ	Single Instruction Multiple Data (SIMD) instruction that computes the 128-bit carry-less multiplication of two, 64-bit operands without generating and propagating carries.
PECI	Platform Environment Control Interface.
Processor	The 64-bit, single-core or multi-core component (package).
Processor Core	The term "processor core" refers to Si die itself which can contain multiple execution cores. Each execution core has an instruction cache, data cache, and 256-KB L2 cache. All execution cores share the L3 cache.



Table 1-3. Terminology (Sheet 2 of 2)

Term	Description
PCU	Power Control Unit
Rank	A unit of DRAM corresponding four to eight devices in parallel, ignoring ECC. These devices are usually, but not always, mounted on a single side of a DIMM.
SCI	System Control Interrupt. Used in ACPI protocol.
Storage Conditions	A non-operational state. The processor may be installed in a platform, in a tray, or loose. Processors may be sealed in packaging or exposed to free air. Under these conditions, processor landings should not be connected to any supply voltages, have any I/Os biased or receive any clocks. Upon exposure to "free air" (i.e., unsealed packaging or a device removed from packaging material) the processor must be handled in accordance with moisture sensitivity labeling (MSL) as indicated on the packaging material.
SVID	Serial Voltage Identification
System Agent	Consists of all the uncore functions within the processor other than the cores and cache. This includes the integrated memory controller, PCIe controller, PCU, etc.
TDP	Thermal Design Power.
TDC	Thermal Design Current is the maximum current that the VR must be thermally capable of sustaining indefinitely in the worst-case thermal environment defined for the platform.
TPM	Trusted Platform Module
V _{CC}	Processor core power supply.
V _{SS}	Processor ground.
V _{TT}	L3 shared cache, memory controller, and processor I/O power rail.
V _{DDQ}	DDR3 power rail.
V _{CCSA}	System Agent (memory controller, DMI and PCIe controllers) power supply
V _{CCIO}	High Frequency I/O logic power supply
V _{CCPLL}	PLL power supply
x1	Refers to a Link or Port with one Physical Lane.
x4	Refers to a Link or Port with four Physical Lanes.
x8	Refers to a Link or Port with eight Physical Lanes.
x16	Refers to a Link or Port with sixteen Physical Lanes.

§ §



2.0 Product Overview

The *Intel® Xeon® and Intel® Core™ Processors for Communications Infrastructure* is a repackaging of the 2nd Generation Intel® Core™ Mobile Processor family. This document addresses pairing the Intel® Xeon®, Intel® Core™, Intel® Pentium®, and Intel® Celeron® processors with an Intel® Platform Controller Hub (known as the PCH), which is referred to as the Crystal Forest Platform. This platform was developed to provide flexible design options, powerful processor performance, and acceleration services that include Intel® QuickAssist Technology. [Figure 2-1](#) shows a block diagram of the Crystal Forest Platform.

Note: The Intel® Xeon®, Intel® Core™, Intel® Pentium®, and Intel® Celeron® processors for this platform are referred to in this document as “the processor”. See [Chapter 5.0](#) for a list of processor SKUs.

The processor is offered in either a Quad Core, Dual Core or Single Core 1284-ball FC-BGA (Flip Chip Ball Grid Array) package. All of the processor offerings are fully pin-compatible and provided in the same 37.5 x 37.5 mm FCBGA package size with a ball pitch of 1.016 mm. The processor is a 64-bit, multi-core processor built on 32-nanometer process technology. It supports DDR3 with Error Correction Code (ECC) and up to 20 PCI Express* lanes. The processor is based on the Intel® micro-architecture, formerly code named Sandy Bridge, and is designed for a two-chip platform.

Included in the processor is an integrated memory controller (IMC) and integrated I/O (PCI Express* and DMI) on a single silicon die. This single die solution is known as a monolithic processor. The integration of the memory and PCI Express* controllers into the processor silicon will benefit I/O intensive applications in the communications segments.

Note: The Intel® Xeon®, Intel® Core™, Intel® Pentium®, and Intel® Celeron® processors for this platform do not include the Integrated Display Engine or the Graphics Processor Unit (GPU). Disregard references to graphics and Intel® Turbo Boost in the *2nd Generation Intel® Core™ Processor Family Mobile Datasheet – Volume 2*.

Figure 2-1. Crystal Forest Platform Example Block Diagram

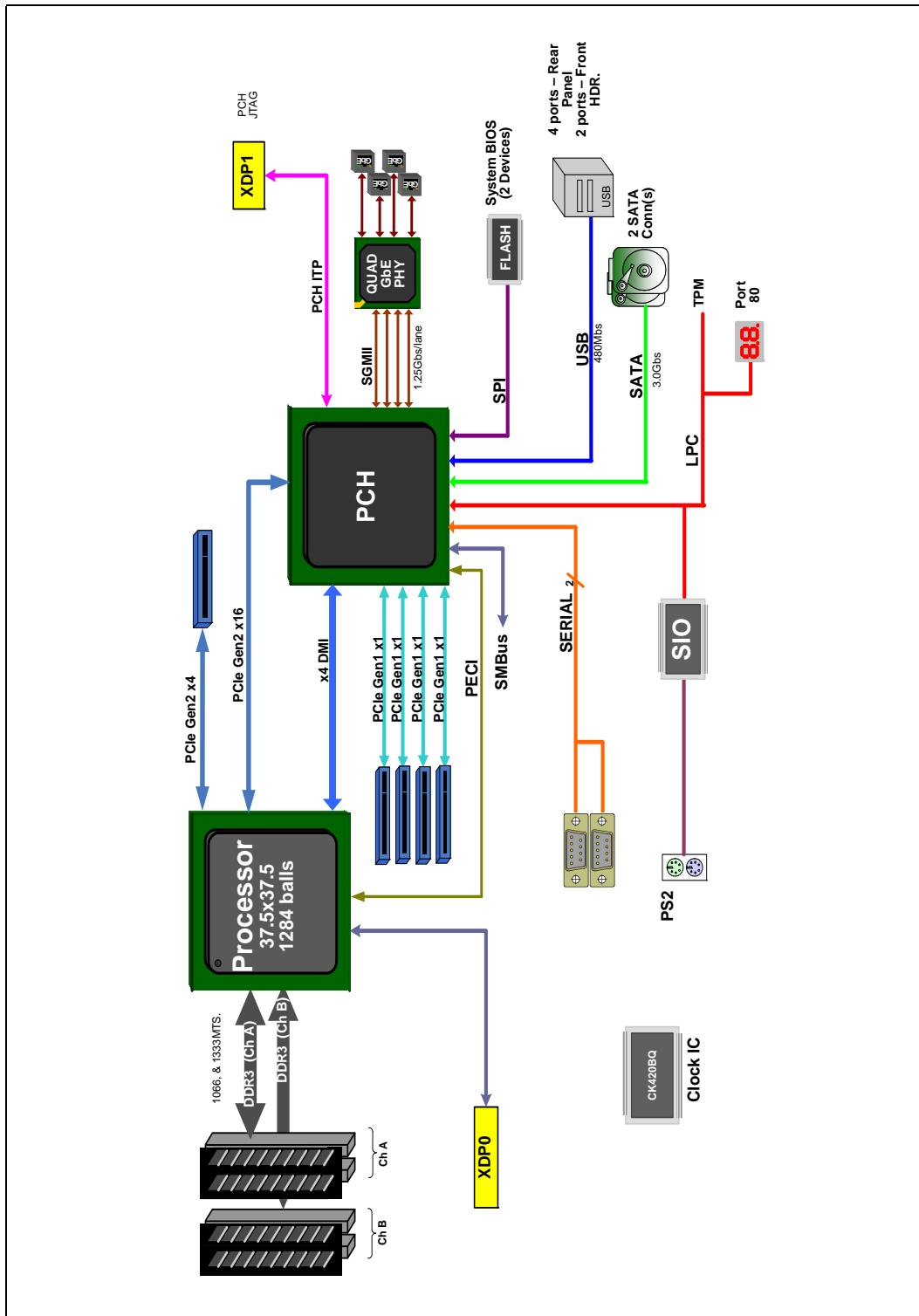



2.1 Product Features

2.2 Processor Details

- Four, two or single execution cores (4C, 2C or 1C respectively)
- 32-KB data first-level cache (L1) for each core, parity protected
- 32-KB instruction first-level cache (L1) for each core, ECC protected
- 256-KB shared instruction/data second-level cache (L2) for each core, ECC protected
- Up to 8-MB shared instruction/data third-level cache (L3) across all cores, ECC protected

2.3 Supported Technologies

- Intel® Virtualization Technology for Directed I/O (Intel® VT-d)
- Intel® Virtualization Technology (Intel® VT-x)
- Intel® Streaming SIMD Extensions 4.1 (Intel® SSE4.1)
- Intel® Streaming SIMD Extensions 4.2 (Intel® SSE4.2)
- Intel® Hyper-Threading Technology
- Intel® 64 Architecture
- Execute Disable Bit
- Intel® Advanced Vector Extensions (Intel® AVX)
- Advanced Encryption Standard New Instructions (AES-NI)
- PCLMULQDQ Instruction

2.4 Interface Features

2.4.1 System Memory Support

- One or two channels of DDR3 memory with a maximum of two UDIMMs or two SO-DIMMs per channel
- ECC Memory Down topology of up to eighteen x8 SDRAM Devices per channel
- Non-ECC Memory Down topology of up to eight x16 DDR3 SDRAM Devices per channel
- Single- and dual-channel memory organization modes
- Memory capacity supported from 512 MB up to 32 GB
- Using 4-Gb device technologies, the largest total memory capacity possible is 32 GB, assuming Dual Channel Mode with four x8, double-sided, dual ranked unbuffered DIMM memory configuration
- 1-Gb, 2-Gb and 4-Gb DDR3 DRAM technologies are supported for x8 and x16 devices
 - Using 4Gb device technology, the largest memory capacity possible is 16 GB, assuming dual-channel mode with two x8, dual-ranked, un-buffered, DIMM memory configuration.
- Data burst length of eight for all memory organization modes
- Memory DDR3 data transfer rates of 1066 MT/s, 1333 MT/s and 1600 MT/s



- 72-bit wide channels, 64-bit data + 8-bit ECC
- 64-bit wide channels, without ECC option
- DDR3 I/O Voltage of 1.5 V
- Supports ECC and non-ECC, unbuffered DDR3 DIMMs
 - Mixing of ECC and Non-ECC DIMMS is not supported
- Theoretical maximum memory bandwidth of:
 - 17.1 GB/s in dual-channel mode assuming DDR3 1066 MT/s
 - 21.3 GB/s in dual-channel mode assuming DDR3 1333 MT/s
 - 25.6 GB/s in dual-channel mode assuming DDR3 1600 MT/s
- Up to 64 simultaneous open pages, 32 per channel (assuming 8 ranks of 8 bank devices)
- Memory organizations:
 - Single-channel modes
 - Dual-channel modes - Intel® Flex Memory Technology:
Dual-channel symmetric (Interleaved)
- Command launch modes of 1n/2n
- On-Die Termination (ODT)
- Intel® Fast Memory Access (Intel® FMA):
 - Just-in-Time Command Scheduling
 - Command Overlap
 - Out-of-Order Scheduling

2.4.2 PCI Express*

The PCI Express* port(s) are fully-compliant to the *PCI Express Base Specification*, Rev. 2.0.

The following configurations are supported:

Configuration 1

- One 16-lane PCI Express* port intended to connect Processor Root Port to PCH End Point
- One 4-lane PCI Express* port intended for I/O
- Four single-lane PCI Express* ports intended for I/O via the PCH

Configuration 2

- One 8-lane PCI Express* port intended to connect Processor Root Port to PCH End Point
- One 8-lane PCI Express* port intended for I/O
- One 4-lane PCI Express* port intended for I/O
- Four single-lane PCI Express* ports intended for I/O via the PCH

Configuration 3

- One 4-lane PCI Express* port intended to connect Processor Root Port to PCH End Point
- Three 4-lane PCI Express* port intended for I/O



- Four single-lane PCI Express* ports intended for I/O via the PCH
- PCI Express* 1 x16 port is mapped to PCI Device 1.
 - One 16-lane/Two 8-lane/One 8-lane and Two 4-lane PCI Express* port
- PCI Express* 1 x4 port is mapped to PCI Device 6.
- The port may negotiate down to narrower widths.
 - Support for x16/x8/x4/x1 widths for a single PCI Express* mode.
- 2.5 GT/s and 5.0 GT/s PCI Express* frequencies are supported.
- Gen1 Raw bit-rate on the data pins of 2.5 Gb/s, resulting in a real bandwidth per pair of 250 MB/s given the 8b/10b encoding used to transmit data across this interface. This also does not account for packet overhead and link maintenance.
- Maximum theoretical bandwidth on interface of 4 GB/s in each direction simultaneously, for an aggregate of 8 GB/s when x16 Gen 1.
- Gen2 Raw bit-rate on the data pins of 5.0 Gb/s, resulting in a real bandwidth per pair of 500 MB/s given the 8b/10b encoding used to transmit data across this interface. This also does not account for packet overhead and link maintenance.
- Maximum theoretical bandwidth on interface of 8 GB/s in each direction simultaneously, for an aggregate of 8 GB/s when x16 Gen 2.
- Hierarchical PCI-compliant configuration mechanism for downstream devices.
- Traditional PCI style traffic (asynchronous snooped, PCI ordering).
- PCI Express* extended configuration space. The first 256 bytes of configuration space aliases directly to the PCI Compatibility configuration space. The remaining portion of the fixed 4-KB block of memory-mapped space above that (starting at 100h) is known as extended configuration space.
- PCI Express* Enhanced Access Mechanism. Accessing the device configuration space in a flat memory mapped fashion.
- Automatic discovery, negotiation, and training of link out of reset.
- Traditional AGP style traffic (asynchronous non-snooped, PCI-X Relaxed ordering).
- Peer segment destination posted write traffic (no peer-to-peer read traffic) in Virtual Channel 0:
 - DMI -> PCI Express* Port 1
 - DMI -> PCI Express* Port 2
 - PCI Express* Port 1 -> DMI
 - PCI Express* Port 2 -> DMI
- 64-bit downstream address format, but the processor never generates an address above 64 GB (Bits 63:36 will always be zeros).
- 64-bit upstream address format, but the processor responds to upstream read transactions to addresses above 64 GB (addresses where any of Bits 63:36 are nonzero) with an Unsupported Request response. Upstream write transactions to addresses above 64 GB will be dropped.
- Re-issues configuration cycles that have been previously completed with the Configuration Retry status.
- PCI Express* reference clock is 100-MHz differential clock.
- Power Management Event (PME) functions.
- Dynamic width capability
- Message Signaled Interrupt (MSI and MSI-X) messages.
- Polarity inversion.



- Static lane numbering reversal
 - Does not support dynamic lane reversal, as defined (optional) by the *PCI Express Base Specification, Rev. 2.0*.
- Supports Half Swing “low-power/low-voltage” mode.

Note: The processor does not support PCI Express* Hot-Plug.

2.4.3 Direct Media Interface (DMI)

- DMI 2.0 support.
- Four lanes in each direction.
- 2.5 GT/s and 5.0 GT/s DMI interface to PCH
- Gen1 Raw bit-rate on the data pins of 2.5 GT/s, resulting in a real bandwidth per pair of 250 MB/s given the 8b/10b encoding used to transmit data across this interface. Does not account for packet overhead and link maintenance.
- Gen2 Raw bit-rate on the data pins of 5.0 GT/s, resulting in a real bandwidth per pair of 500 MB/s given the 8b/10b encoding used to transmit data across this interface. Does not account for packet overhead and link maintenance.
- Maximum theoretical bandwidth on interface of 2 GB/s in each direction simultaneously, for an aggregate of 4 GB/s when DMI x4.
- Shares 100-MHz PCI Express* reference clock.
- 64-bit downstream address format, but the processor never generates an address above 64 GB (Bits 63:36 will always be zeros).
- 64-bit upstream address format, but the processor responds to upstream read transactions to addresses above 64 GB (addresses where any of Bits 63:36 are nonzero) with an Unsupported Request response. Upstream write transactions to addresses above 64 GB will be dropped.
- Supports the following traffic types to or from the PCH:
 - DMI -> DRAM
 - DMI -> processor core (Virtual Legacy Wires (VLWs), Resetwarn, or MSIs only)
 - Processor core -> DMI
- APIC and MSI interrupt messaging support:
 - Message Signaled Interrupt (MSI and MSI-X) messages
- Downstream SMI, SCI and SERR error indication.
- Legacy support for ISA regime protocol (PHOLD/PHOLDA) required for parallel port DMA, floppy drive, and LPC bus masters.
- DC coupling – no capacitors between the processor and the PCH.
- Polarity inversion.
- PCH end-to-end lane reversal across the link.
- Supports Half Swing “low-power/low-voltage”.

2.4.4 Platform Environment Control Interface (PECI)

The PECI is a one-wire interface that provides a communication channel between a PECI client (the processor) and a PECI master. The processors support the PECI 3.0 Specification.



2.5 Power Management Support

2.5.1 Processor Core

- Full support of ACPI C-states as implemented by the following processor C-states: C0, C1, C1E, C3, C6, C7
- Enhanced Intel SpeedStep® Technology

2.5.2 System

Full support of the ACPI S-states as implemented by the following system S-states: S0, S3, S4, S5

2.5.3 Memory Controller

- Conditional self-refresh (Intel® Rapid Memory Power Management (Intel® RMPM))
- Dynamic power-down

2.5.4 PCI Express*

- L0s and L1 ASPM power management capability

2.5.5 DMI

- L0s and L1 ASPM power management capability

2.6 Thermal Management Support

- Digital Thermal Sensor
- Intel® Adaptive Thermal Monitor
- THERMTRIP# and PROCHOT# support
- On-Demand Mode
- Memory Thermal Throttling
- External Thermal Sensor (TS-on-DIMM and TS-on-Board)
- Fan speed control with DTS

2.7 Package

- The processor is available in one package size:
 - A 37.5 x 37.5 mm 1284-ball FCBGA package (BGA1284)
 - 1.016 mm ball pitch

2.8 Testability

The processor includes boundary-scan for board and system level testability.







3.0 Interfaces

This chapter describes the interfaces supported by the processor.

3.1 System Memory Interface

3.1.1 System Memory Configurations Supported

The Integrated Memory Controller (IMC) of the processor supports DDR3 protocols with two independent, 72-bit wide channels. These two memory channels are capable of running speeds up to 1600MT/s. Each channel consists of 64 data and 8 ECC bits. In the dual-channel configuration, it supports DIMMs on both channels, or DIMMs on one channel and memory down configuration on the other channel, or memory down configuration on both channels. The processor supports up to two DIMMs per channel.

Note: Very Low Profile (VLP) UDIMMs are supported wherever UDIMMs are supported. However, VLP UDIMMs have not been fully validated.

Note: Mixing of ECC and Non-ECC DIMMs is not supported.



3.1.1.1 UDIMM Configurations

This section describes the UDIMM modules supported.

The following DDR3 Data Transfer Rates are supported:

- 1066 MT/s (PC3-8500), 1333 MT/s (PC3-10600), and 1600 MT/s (PC3-12800)
- DDR3 UDIMM Modules:
 - Raw Card A - Single Sided x8 unbuffered non-ECC
 - Raw Card B - Double Sided x8 unbuffered non-ECC
 - Raw Card C - Single Sided x16 unbuffered non-ECC
 - Raw Card D - Single Sided x8 unbuffered ECC
 - Raw Card E - Double Sided x8 unbuffered ECC
- DDR3 DRAM Device Technology

Standard 1-Gb, 2-Gb, and 4-Gb technologies and addressing are supported for x16 and x8 devices. There is no support for memory modules with different technologies or capacities on opposite sides of the same memory module. If one side of a memory module is populated, the other side is either identical or empty.

Table 3-1. Supported UDIMM Module Configurations^{1, 2}

Raw Card Version	DIMM Capacity	DRAM Device Technology	DRAM Organization	# of DRAM Devices	# of Physical Device Ranks	# of Row/Col Address Bits	# of Banks Inside DRAM	Page Size
Unbuffered/Non-ECC Supported DIMM Module Configurations								
A	1 GB	1 Gb	128 M X 8	8	2	14/10	8	8 K
	2 GB	2 Gb	128 M X 16	16	2	14/10	8	16 K
B	2 GB	1 Gb	128 M X 8	16	2	14/10	8	8 K
	4 GB	2 Gb	256 M X 8	16	2	15/10	8	8 K
	8 GB	4Gb	512 M X 8	16	2	16/10	8	8 K
C	512 MB	1 Gb	64 M X 16	4	1	13/10	8	16 K
	1 GB	2 Gb	128 M X 16	4	1	14/10	8	16 K
Unbuffered/ECC Supported DIMM Module Configurations								
D	1 GB	1 Gb ³	128 M X 8	9	1	14/10	8	8 K
	2 GB	2 Gb ³	256 M X 8	9	1	15/10	8	8 K
E	2 GB	1 Gb	128 M X 8	18	2	14/10	8	8 K
	4 GB	2 Gb	256 M X 8	18	2	15/10	8	8 K
	8 GB	4 Gb	512 M X 8	18	2	16/10	8	8 K

Notes:

1. DIMM module support is based on availability and is subject to change.
2. Interface does not support DDR3L nor DDR3U DIMMs.
3. Supported but not fully validated.



3.1.1.2 SO-DIMM Configurations

The processor supports SO-DIMM and ECC SO-DIMM designs. Table 3-2 details the SO-DIMM modules that are supported. However, these have not been fully validated.

Table 3-2. Supported SO-DIMM Module Configurations^{1, 2}

Raw Card Version	DIMM Capacity	DRAM Device Technology	DRAM Organization	# of DRAM Devices	# of Physical Device Ranks	# of Row/Col Address Bits	# of Banks Inside DRAM	Page Size
Unbuffered/Non-ECC Supported SO-DIMM Module Configurations								
A	1 GB	1 Gb ^{3,4}	64 M X 16	8	2	13/10	8	8 K
	2 GB	2 Gb ^{3,4}	128 M X 16	8	2	14/10	8	8 K
B	1 GB	1 Gb ^{3,4}	128 M X 8	8	1	14/10	8	8 K
	2GB	2 Gb ^{3,4}	256 M X 8	8	1	15/10	8	8 K
C	512 MB	1 Gb ^{3,4}	64 M X 16	4	1	13/10	8	8 K
	1 GB	2 Gb ^{3,4}	128 M X 16	4	1	14/10	8	8 K
F	2 GB	1 Gb ^{3,4}	128 M X 8	16	2	14/10	8	8 K
	4 GB	2 Gb ^{3,4}	256 M X 8	16	2	15/10	8	8 K
	8 GB	4 Gb ^{3,4}	512 M X 8	16	2	16/10	8	8 K
Unbuffered/ECC Supported SO-DIMM Module Configurations								
D	1 GB	1 Gb ³	128 M X 8	9	1	14/10	8	8 K
	2 GB	2 Gb ³	256 M X 8	9	1	15/10	8	8 K
E	2 GB	1 Gb ³	128 M X 8	18	2	14/10	8	8 K
	4 GB	2 Gb ³	256 M X 8	18	2	15/10	8	8 K
	8 GB	4 Gb ³	512 M X 8	18	2	16/10	8	8 K

Notes:

1. DIMM module support is based on availability and is subject to change.
2. Interface does not support DDR3L nor DDR3U SO-DIMMs.
3. Supported, but not fully validated on Intel® Xeon® and Intel® Core™ Processors **for Communications Infrastructure**.
4. Fully Validated on 2nd Generation Intel® Core™ Processor Family **Mobile** processors.



3.1.1.3 Memory Down Configurations

The processor supports the following Memory Down configurations.

Table 3-3. Supported Memory Down Configurations ¹

Raw Card Equivalent	Memory Capacity	DRAM Device Technology	DRAM Organization	# of DRAM Devices	# of Physical Device Ranks	# of Row/Col Address Bits	# of Banks Inside DRAM	Page Size
Unbuffered/Non-ECC Supported Memory Down Configurations								
A	1 GB	1 Gb ²	64 M X 16	8	2	13/10	8	8 K
	2 GB	2 Gb ²	128 M X 16	8	2	14/10	8	8 K
B	1 GB	1 Gb ²	128 M X 8	8	1	14/10	8	8 K
	2GB	2 Gb ²	256 M X 8	8	1	15/10	8	8 K
C	512 MB	1 Gb ²	64 M X 16	4	1	13/10	8	8 K
	1 GB	2 Gb ²	128 M X 16	4	1	14/10	8	8 K
F	2 GB	1 Gb ²	128 M X 8	16	2	14/10	8	8 K
	4 GB	2 Gb ²	256 M X 8	16	2	15/10	8	8 K
	8 GB	4 Gb ²	512 M X 8	16	2	16/10	8	8 K
Unbuffered/ECC Supported Memory Down Configurations								
D	1 GB	1 Gb ²	128 M X 8	9	1	14/10	8	8 K
	2 GB	2 Gb ²	256 M X 8	9	1	15/10	8	8 K
E	2 GB	1 Gb ²	128 M X 8	18	2	14/10	8	8 K
	4 GB	2 Gb ²	256 M X 8	18	2	15/10	8	8 K
	8 GB	4 Gb ²	512 M X 8	18	2	16/10	8	8 K

Notes:

1. Interface does not support memory devices running at DDR3L (1.35 V) or DDR3U (1.25 V) Voltage Levels.
2. Supported, but not fully validated.

3.1.2 System Memory Timing Support

The processor supports the following DDR3 Speed Bin, CAS Write Latency (CWL), and command signal mode timings on the main memory interface:

- tCL = CAS Latency
- tRCD = Activate Command to READ or WRITE Command delay
- tRP = PRECHARGE Command Period
- CWL = CAS Write Latency
- Command Signal modes = 1n indicates a new command may be issued every clock and 2n indicates a new command may be issued every 2 clocks. Command launch mode programming depends on the transfer rate and memory configuration.



Table 3-4. DDR3 System Memory Timing Support

Processor SKUs	DIMMs Per Channel	Transfer Rate (MT/s)	tCL (tCK)	tRCD (tCK)	tRP (tCK)	CWL (tCK)	CMD Mode
4-Core SKUs	1 DPC 2 DPC	1066	7	7	7	6	1n/2n
	1 DPC 2 DPC	1333	9	9	9	7	1n/2n
	1 DPC only	1600	11	11	11	8	1n/2n
2-Core SKUs	1 DPC 2 DPC	1066	7	7	7	6	1n/2n
			8	8	8	6	1n/2n
	1 DPC 2 DPC	1333	9	9	9	7	1n/2n
1-Core SKUs	1 DPC only	1066	7	7	7	6	1n/2n
			8	8	8	6	1n/2n

Note: System memory timing support is based on availability and is subject to change.

3.1.3 System Memory Organization Modes

The processor supports two memory organization modes, single-channel and dual-channel. Depending upon how the DIMM Modules are populated in each memory channel, a number of different configurations can exist.

3.1.3.1 Single-Channel Mode

In this mode, all memory cycles are directed to a single-channel. Single-channel mode is used when either Channel A or Channel B DIMM connectors are populated in any order, but not both.

3.1.3.2 Dual-Channel Mode - Intel® Flex Memory Technology Mode

The processor supports Intel® Flex Memory Technology Mode. Memory is divided into a symmetric and an asymmetric zone. The symmetric zone starts at the lowest address in each channel and is contiguous until the asymmetric zone begins or until the top address of the channel with the smaller capacity is reached. In this mode, the system runs with one zone of dual-channel mode and one zone of single-channel mode, simultaneously, across the whole memory array.

Note: Channels A and B can be mapped for physical channels 0 and 1 respectively or vice versa; however, channel A size must be greater or equal to channel B size.

Figure 3-1. Intel® Flex Memory Technology Operation

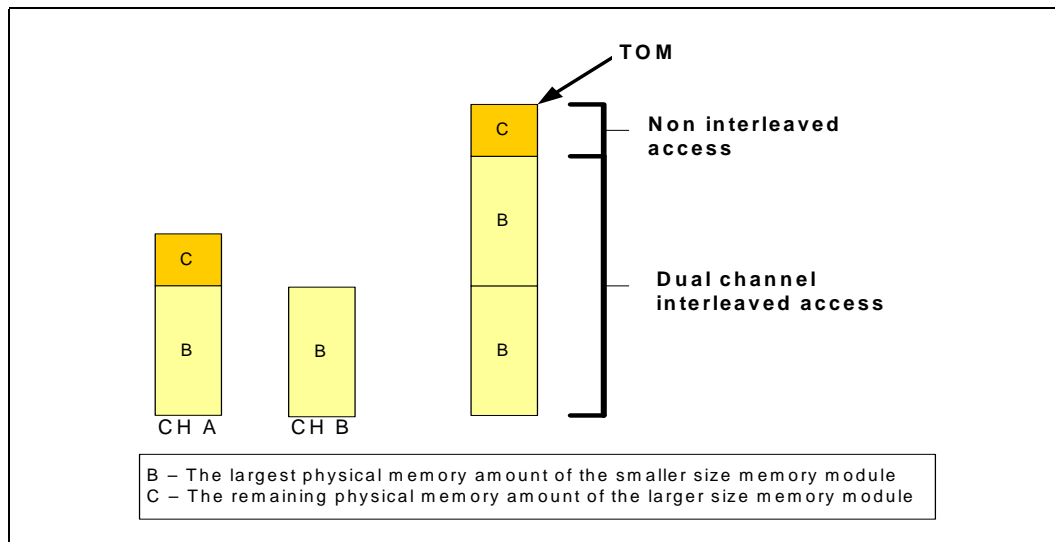

3.1.3.2.1 Dual-Channel Symmetric Mode

Dual-Channel Symmetric mode, also known as interleaved mode, provides maximum performance on real world applications. Addresses are ping-ponged between the channels after each cache line (64-byte boundary). If there are two requests, and the second request is to an address on the opposite channel from the first, that request can be sent before data from the first request has returned. If two consecutive cache lines are requested, both may be retrieved simultaneously, since they are ensured to be on opposite channels. Use Dual-Channel Symmetric mode when both Channel A and Channel B DIMM connectors are populated in any order, with the total amount of memory in each channel being the same.

When both channels are populated with the same memory capacity and the boundary between the dual channel zone and the single channel zone is the top of memory, IMC operates completely in Dual-Channel Symmetric mode.

Note: The DRAM device technology and width may vary from one channel to the other.

3.1.4 Rules for Populating Memory Slots

In all modes, the frequency of system memory is the lowest frequency of all memory modules placed in the system, as determined through the SPD registers on the memory modules. The system memory controller supports one or two DIMM connectors per channel. The usage of DIMM modules with different latencies is allowed. For dual-channel modes both channels must have a DIMM connector populated and for single-channel mode only a single-channel can have an DIMM connector populated.

3.1.5 Technology Enhancements of Intel® Fast Memory Access (Intel® FMA)

The following sections describe the Just-in-Time Scheduling, Command Overlap, and Out-of-Order Scheduling Intel FMA technology enhancements.



3.1.5.1 Just-in-Time Command Scheduling

The memory controller has an advanced command scheduler where all pending requests are examined simultaneously to determine the most efficient request to be issued next. The most efficient request is picked from all pending requests and issued to system memory Just-in-Time to make optimal use of Command Overlapping. Thus, instead of having all memory access requests go individually through an arbitration mechanism forcing requests to be executed one at a time, they can be started without interfering with the current request allowing for concurrent issuing of requests. This allows for optimized bandwidth and reduced latency while maintaining appropriate command spacing to meet system memory protocol.

3.1.5.2 Command Overlap

Command Overlap allows the insertion of the DRAM commands between the Activate, Precharge, and Read/Write commands normally used, as long as the inserted commands do not affect the currently executing command. Multiple commands can be issued in an overlapping manner, increasing the efficiency of system memory protocol.

3.1.5.3 Out-of-Order Scheduling

While leveraging the Just-in-Time Scheduling and Command Overlap enhancements, the IMC continuously monitors pending requests to system memory for the best use of bandwidth and reduction of latency. If there are multiple requests to the same open page, these requests would be launched in a back to back manner to make optimum use of the open memory page. This ability to reorder requests on the fly allows the IMC to further reduce latency and increase bandwidth efficiency.

3.1.5.4 Memory Type Range Registers (MTRRs) Enhancement

In this processor there are additional 2 MTRRs (total 10 MTRRs). These additional MTRRs are specially important in supporting larger system memory beyond 4GB.

3.1.6 Data Scrambling

The memory controller incorporates a DDR3 Data Scrambling feature to minimize the impact of excessive di/dt on the platform DDR3 VRs due to successive 1's and 0's on the data bus. Past experience has demonstrated that traffic on the data bus is not random and can have energy concentrated at specific spectral harmonics creating high di/dt which is generally limited by data patterns that excite resonance between the package inductance and on die capacitances. As a result the memory controller uses a data scrambling feature to create pseudo-random patterns on the DDR3 data bus to reduce the impact of any excessive di/dt.

3.1.7 DRAM Clock Generation

Every supported DIMM has two differential clock pairs. There are total of four clock pairs driven directly by the processor to two DIMMs.

3.2 PCI Express* Interface

This section describes the PCI Express* interface capabilities of the processor. See the PCI Express Base Specification for details of PCI Express*.

The processor has a total of 20 PCI Express* lanes. These lanes are fully compliant with PCI Express Base Specification Revision 2.0. This section will discuss how these 20 PCI Express* lanes can be utilized in various configurations on the platform.

The processor has four PCI Express* controllers that can be independently configured to either Gen 1 or Gen 2, allowing operation at both 2.5 GT/s (Giga-Transfers per second) and 5.0 GT/s data rates. These four PCIe* devices operate simultaneously which are configurable in the following combinations:

- 1 x16 PCI Express* Port with 1 x4 PCI Express Port
- 2 x8 PCI Express* Ports with 1 x4 PCI Express* Port
- 1 x8 PCI Express* Ports with 3 x4 PCI Express* Ports

The 1 Core SKU (see Table 5-1, “Base Features by SKU”) only supports 16 PCI Express* Ports, and a maximum of three PCIe* devices. These three PCIe* devices operate simultaneously which are configurable in the following combinations:

- 1 x16 PCI Express* Port
- 2 x8 PCI Express* Ports
- 1 x8 PCI Express* Port with 2 x4 PCI Express* Ports
- 3 x4 PCI Express* Ports

3.2.1 PCI Express* Architecture

Compatibility with the PCI addressing model is maintained to ensure that all existing applications and drivers operate unchanged.

The PCI Express* configuration uses standard mechanisms as defined in the PCI Plug-and-Play specification. The initial recovered clock speed of 1.25 GHz results in 2.5 Gb/s/direction which provides a 250 MB/s communications channel in each direction (500 MB/s total). That is nearly twice the data rate of classic PCI. The fact that 8b/10b encoding is used accounts for the 250 MB/s where quick calculations would imply 300 MB/s. The external ports support Gen2 speed as well. At 5.0 GT/s, Gen 2 operation results in double the bandwidth per lane as compared to Gen 1 operation. When operating with two PCIe* controllers, each controller can be operating at either 2.5 GT/s or 5.0 GT/s.

The PCI Express* architecture is specified in three layers: Transaction Layer, Data Link Layer, and Physical Layer. The partitioning in the component is not necessarily along these same boundaries. See Figure 3-2 for the PCI Express* Layering Diagram.

Figure 3-2. PCI Express* Layering Diagram

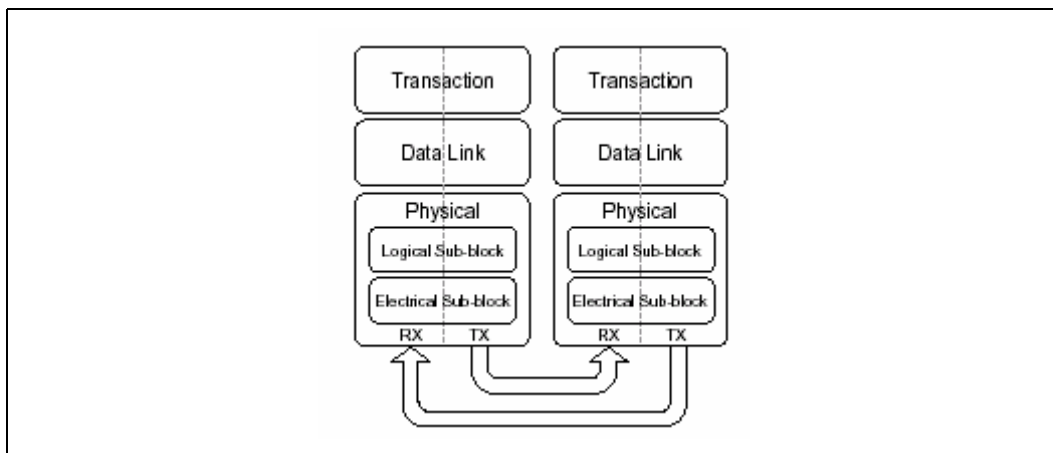



PCI Express* uses packets to communicate information between components. Packets are formed in the Transaction and Data Link Layers to carry the information from the transmitting component to the receiving component. As the transmitted packets flow through the other layers, they are extended with additional information necessary to handle packets at those layers. At the receiving side, the reverse process occurs and packets get transformed from their Physical Layer representation to the Data Link Layer representation and finally (for Transaction Layer Packets) to the form that can be processed by the Transaction Layer of the receiving device.

Figure 3-3. Packet Flow through the Layers

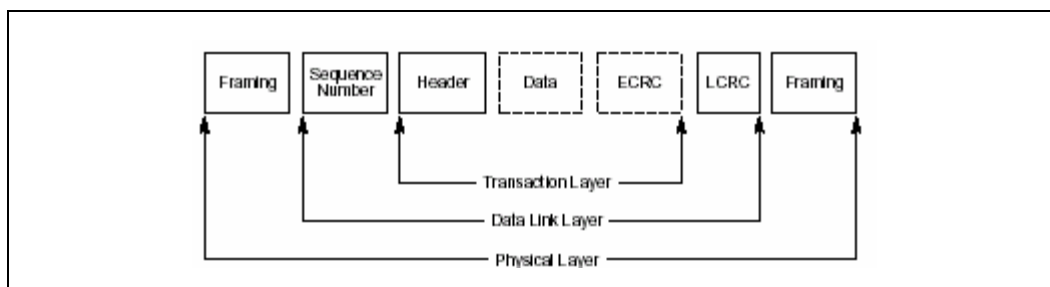

3.2.1.1 Transaction Layer

The upper layer of the PCI Express* architecture is the Transaction Layer. The Transaction Layer's primary responsibility is the assembly and disassembly of Transaction Layer Packets (TLPs). TLPs are used to communicate transactions, such as read and write, as well as certain types of events. The Transaction Layer also manages flow control of TLPs.

3.2.1.2 Data Link Layer

The middle layer in the PCI Express* stack, the Data Link Layer, serves as an intermediate stage between the Transaction Layer and the Physical Layer. Responsibilities of Data Link Layer include link management, error detection, and error correction.

The transmission side of the Data Link Layer accepts TLPs assembled by the Transaction Layer, calculates and applies data protection code and TLP sequence number, and submits them to Physical Layer for transmission across the Link. The receiving Data Link Layer is responsible for checking the integrity of received TLPs and for submitting them to the Transaction Layer for further processing. On detection of TLP error(s), this layer is responsible for requesting retransmission of TLPs until information is correctly received, or the Link is determined to have failed. The Data Link Layer also generates and consumes packets which are used for Link management functions.

3.2.1.3 Physical Layer

The Physical Layer includes all circuitry for interface operation, including driver and input buffers, parallel-to-serial and serial-to-parallel conversion, PLL(s), and impedance matching circuitry. It also includes logical functions related to interface initialization and maintenance. The Physical Layer exchanges data with the Data Link Layer in an implementation-specific format, and is responsible for converting this to an appropriate serialized format and transmitting it across the PCI Express* Link at a frequency and width compatible with the remote device.

3.2.2 PCI Express* Configuration Mechanism

All of the PCI Express* controllers are mapped through a PCI-to-PCI bridge structure.

The controllers for the 16 lanes (Port 1) are mapped to the root port of Device 1:

- The x16 controller is mapped to Function 0
- The x8 controller is mapped to Function 1
- The x4 controller is mapped to Function 2

The additional x4 controller for lanes (Port 2) is mapped to Device 6 Function 0. Port 2 is not available on 1 Core SKUs. (see Table 5-1, “Base Features by SKU”)

3 of the 4 controllers create Port 1 and can automatically operate on lower lane width modes allowing up to 3 simultaneous operating devices on these 16 lanes. Bifurcation details are described in Section 3.2.3, “PCI Express* Port Bifurcation”, and the hardware straps required to enable the x16, x8 and the x4 controllers are described in Section 3.2.4, “PCI Express* Lanes Connection”.

The fourth controller is a single dedicated controller, which creates the x4 Port 2 that enumerates on Device 6. Port 2 can be configured to operate in 1x4, 1x2 or 1x1 mode, but there are no hardware straps.

Note: The controllers in Port 1 cannot be used to function with the controller in Port 2. Therefore, the x16 lanes of Port 1 must not be combined with the x4 lanes of Port 2.

Figure 3-4. PCI Express* Related Register Structures

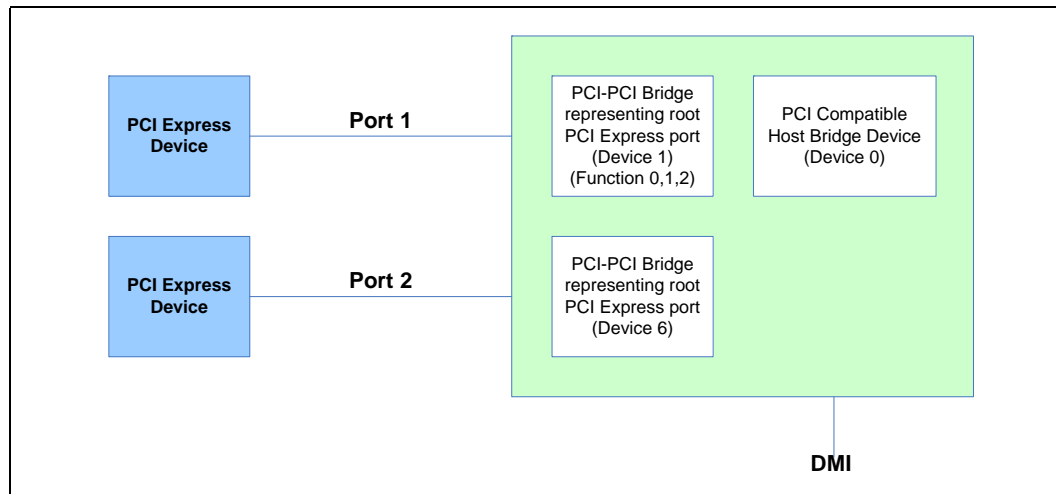

3.2.3 PCI Express* Port Bifurcation

Only the 3 controllers on Port 1 can be bifurcated. When bifurcated, the wires which had previously been assigned to lanes [15:8] of the single x16 primary port are reassigned to lanes [7:0] of the x8 secondary controller (Function 1). This assignment applies whether the lane numbering is reversed or not. Further bifurcation of Port 1 is possible through the third controller (Function 2) to create two x4 PCI Express*.

When Port 1 is not bifurcated, Function 1 and Function 2 are hidden from the discovery mechanism used in PCI enumeration.

The controls for Port 2 and the associated virtual PCI-to-PCI bridge can be found in PCI Device 6, which provides an additional x4 Port.



Figure 3-5. PCI Express* PCI Port Bifurcation

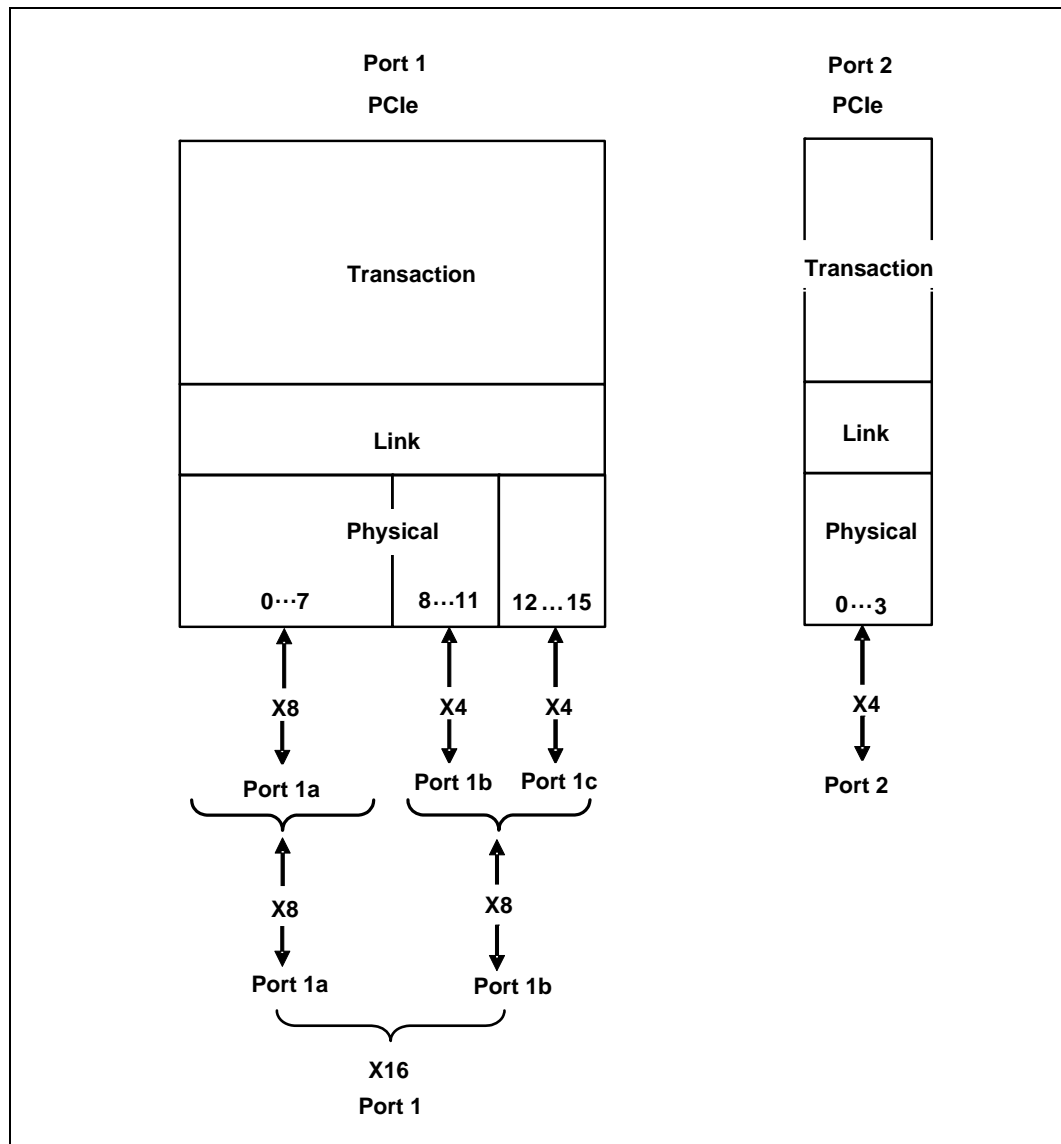

3.2.4 PCI Express* Lanes Connection

Figure 3-6 demonstrates the PCIe* lanes mapping.

Figure 3-6. PCIe* Typical Operation 16 Lanes Mapping

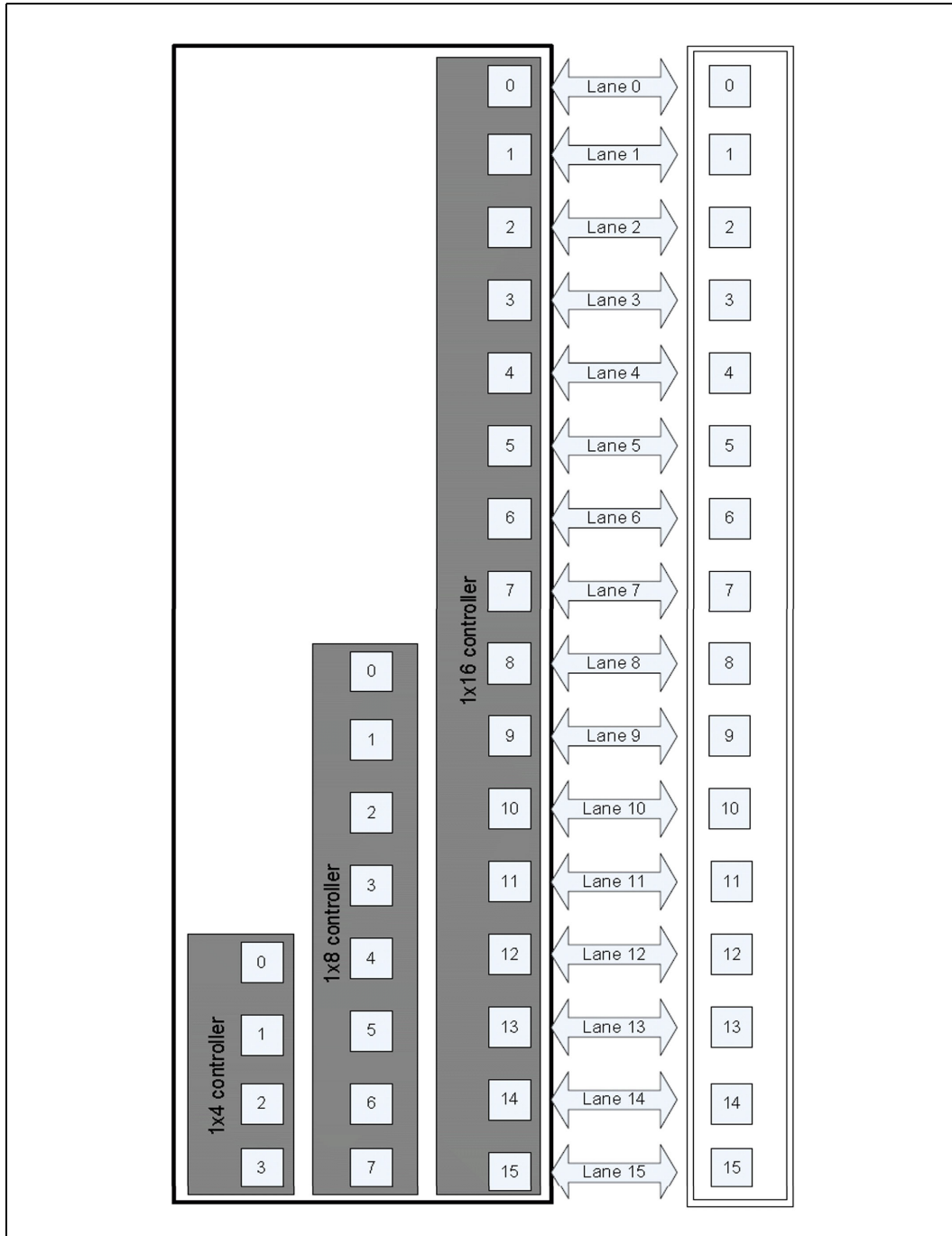



3.2.5 Configuring PCIe* Lanes

Note: The controllers in Port 1 cannot be used to function with the controller in Port 2. Therefore, the x16 lanes of Port 1 must not be combined with the x4 lanes of Port 2.

The following details apply to the 3 controllers in Port 1, as Port 2 cannot be bifurcated.

The configuration of the PCIe* bus is statically determined by the pre-boot software prior to initialization. The pre-boot software determines the configuration by looking at the two configuration pins, CFG[6:5], that determine whether the additional 2 controllers of the 16 lanes need to be enabled or not. These strap values are read upon power up and the pre-boot software enables the appropriate number of controllers in use as follows:

Table 3-5. Hardware Straps for PCIe* Controller Enabling (Port 1 Only)

CFG [6:5]	Mode
00	1x8 +2x4
01	Reserved
10	2x8
11 (default)	1x16

No strapping is required to enable the additional four lanes (lanes [16-19]) in any of the permissible modes as it has a single dedicated controller.

The CFG[6:5] inputs have a default value of [1:1] if they are not terminated on the board. By default, a single x16 controller is enabled. When a logic 0 is required on the strap, it is recommended that they be pulled down to ground with a 1 K Ohm resistor

Note: If the x16 controller is enabled by the hardware strapping and a x8 device is plugged in, the controller automatically operates in the x8 mode. The same is true for any controller that is connected to a device operating at narrower lane widths.

Hot plug is not supported on these PCIe* interfaces. If a device is not present at power up, it is not detected when it is plugged in after power up. Also, the strap values are read upon power up and the pre-boot software enables the appropriate controller based on the value read on CFG[6:5]. Hence, if a device of lower lane width than the width of the controller that is enabled is plugged in before power up, then it is automatically detected. But if a device with higher lane width is plugged in, the device is not detected. The same is true for the number of controllers enabled. If a single controller is enabled at power up, then a single device of any width equal to or lower than the width of the controller is detected.

For example, if upon power up, the value on CFG [6:5] is [1:1], then the 1x16 controller is enabled. A single device of width x16 will be detected upon power up. But if two devices of any lower width are plugged in; only the device connected to Device 1, Function 0 will be detected.

3.2.6 Lane Reversal on PCIe* Interface

The PCI Express* lanes can be reversed for ease of design and layout. Lane reversal is done statically, which means that the BIOS needs to configure the reversal before the relevant root port is enabled. For the x16 configuration, only one reversal option is supported allowing either a straight or a rotated CPU on the motherboard. No other combination of partial slot reversal is permitted. The reversal on x8 and x4 configurations are applied in a similar fashion.

The normal or reversed configuration is determined by the configuration pins CFG[2] for PCI express lanes on Port 1 and CFG[3] for lanes on Port 2. A value of '1' on these inputs would indicate normal operation and a '0' would indicate reversed mode of operation, as shown in Table 2.

Table 3-6. Hardware Straps for Normal/Reversed Operation of PCIe* Lanes

PCI-e Lanes	Normal	Reversed
Port 1	CFG [2] =1	CFG [2] =0
Port 2	CFG [3] =1	CFG [3] =0

Note: Performance estimates on early silicon have shown that bandwidth in x16 mode for Gen 2 is approximately twice the bandwidth in x8 mode for read, write and read-write transaction.

3.3 Direct Media Interface

Direct Media Interface (DMI) connects the processor and the PCH. Next generation DMI2 is supported.

Note: Only DMI x4 configuration is supported.

3.3.1 DMI Error Flow

DMI can only generate SERR in response to errors, never SCI, SMI, MSI, PCI INT, or GPE. Any DMI related SERR activity is associated with Device 0.

3.3.2 DMI Link Down

The DMI link going down is a fatal, unrecoverable error. If the DMI data link goes to data link down, after the link was up, then the DMI link hangs the system by not allowing the link to retrain to prevent data corruption. This link behavior is controlled by the PCH.

Downstream transactions that had been successfully transmitted across the link prior to the link going down may be processed as normal. No completions from downstream, non-posted transactions are returned upstream over the DMI link after a link down event.

3.4 Platform Environment Control Interface (PECI)

The PECI is a one-wire interface that provides a communication channel between a PECI client (processor) and a PECI master. The processor implements a PECI interface to:



- Allow communication of processor thermal and other information to the PECI master.
- Read averaged Digital Thermal Sensor (DTS) values for fan speed control.

3.5 Interface Clocking

3.5.1 Internal Clocking Requirements

Table 3-7. Reference Clock

Reference Input Clock	Input Frequency	Associated PLL
BCLK/BCLK#	100 MHz	Processor/Memory/PCIe/DMI

§ §





4.0 Technologies

4.1 Intel® Virtualization Technology

Intel® Virtualization Technology (Intel® VT) makes a single system appear as multiple independent systems to software. This allows multiple, independent operating systems to run simultaneously on a single system. Intel® VT comprises technology components to support virtualization of platforms based on Intel architecture microprocessors and chipsets. Intel® Virtualization Technology (Intel® VT) for IA-32, Intel® 64 and Intel® Architecture (Intel® VT-x) added hardware support in the processor to improve the virtualization performance and robustness. Intel® Virtualization Technology for Directed I/O (Intel® VT-d) adds chipset hardware implementation to support and improve I/O virtualization performance and robustness.

Intel® VT-x specifications and functional descriptions are included in the Intel® 64 and IA-32 Architectures Software Developer's Manual, Volume 3B and is available at

<http://www.intel.com/products/processor/manuals/index.htm>

The Intel® VT-d spec and other VT documents can be referenced at

<http://www.intel.com/technology/platform-technology/virtualization/index.htm>

4.1.1 Intel® VT-x Objectives

Intel® VT-x provides hardware acceleration for virtualization of IA platforms. Virtual Machine Monitor (VMM) can use Intel® VT-x features to provide improved reliable virtualized platform. By using Intel® VT-x, a VMM is:

- **Robust:** VMMs no longer need to use paravirtualization or binary translation. This means that they will be able to run off-the-shelf OSs and applications without any special steps.
- **Enhanced:** Intel® VT enables VMMs to run 64-bit guest operating systems on IA x86 processors.
- **More reliable:** Due to the hardware support, VMMs can now be smaller, less complex, and more efficient. This improves reliability and availability and reduces the potential for software conflicts.
- **More secure:** The use of hardware transitions in the VMM strengthens the isolation of VMs and further prevents corruption of one VM from affecting others on the same system.

4.1.2 Intel® VT-x Features

The processor core supports the following Intel® VT-x features:

- Extended Page Tables (EPT)
 - EPT is hardware assisted page table virtualization
 - It eliminates VM exits from guest OS to the VMM for shadow page-table maintenance



- Virtual Processor IDs (VPID)
 - Ability to assign a VM ID to tag processor core hardware structures (e.g., TLBs)
 - This avoids flushes on VM transitions to give a lower-cost VM transition time and an overall reduction in virtualization overhead.
- Guest Preemption Timer
 - Mechanism for a VMM to preempt the execution of a guest OS after an amount of time specified by the VMM. The VMM sets a timer value before entering a guest
 - The feature aids VMM developers in flexibility and Quality of Service (QoS) guarantees
- Descriptor-Table Exiting
 - Descriptor-table exiting allows a VMM to protect a guest OS from internal (malicious software based) attack by preventing relocation of key system data structures like IDT (interrupt descriptor table), GDT (global descriptor table), LDT (local descriptor table), and TSS (task segment selector).
 - A VMM using this feature can intercept (by a VM exit) attempts to relocate these data structures and prevent them from being tampered by malicious software.

4.1.3 Intel® VT-d Objectives

The key Intel® VT-d objectives are domain-based isolation and hardware-based virtualization. A domain can be abstractly defined as an isolated environment in a platform to which a subset of host physical memory is allocated. Virtualization allows for the creation of one or more partitions on a single system. This could be multiple partitions in the same operating system, or there can be multiple operating system instances running on the same system, offering benefits like system consolidation, legacy migration, activity partitioning, or security.

4.1.4 Intel® VT-d Features

The processor supports the following Intel® VT-d features:

- Memory controller complies with Intel® VT-d 1.2 specification.
- Intel® VT-d DMA remap engines.
 - DMI (non-high def audio)
 - PCI Express*
- Support for root entry, context entry and default context
- 39-bit guest physical address and host physical address widths
- Support for 4K page sizes only
- Support for register-based fault recording only (for single entry only) and support for MSI interrupts for faults
- Support for both leaf and non-leaf caching
- Support for boot protection of default page table
- Support for non-caching of invalid page table entries
- Support for hardware based flushing of translated but pending writes and pending reads, on IOTLB invalidation
- Support for page-selective IOTLB invalidation



- MSI cycles (MemWr to address FEE_xxxxh) not translated
 - Translation faults result in cycle forwarding to VBIOS region (byte enables masked for writes). Returned data may be bogus for internal agents, PEG/DMI interfaces return unsupported request status
- Interrupt Remapping is supported
- Queued invalidation is supported.
- VT-d translation bypass address range is supported (Pass Through)
- Support for ARI (Alternative Requester ID - a PCI SIG ECR for increasing the function number count in a PCIe device) to support IOV devices.

4.1.5 Intel® VT-d Features Not Supported

The following features are not supported by the processor with Intel® VT-d:

- No support for PCISIG endpoint caching (ATS)
- No support for Intel® VT-d read prefetching/snarfing i.e. translations within a cacheline are not stored in an internal buffer for reuse for subsequent translations.
- No support for advance fault reporting
- No support for super pages
- No support for Intel® VT-d translation bypass address range (such usage models need to be resolved with VMM help in setting up the page tables correctly)

4.2 Intel® Hyper-Threading Technology

The processor supports Intel® Hyper-Threading Technology (Intel® HT Technology), which allows an execution core to function as two logical processors. While some execution resources such as caches, execution units, and buses are shared, each logical processor has its own architectural state with its own set of general-purpose registers and control registers. This feature must be enabled via the BIOS and requires operating system support.

Intel recommends enabling Hyper-Threading Technology with Microsoft Windows 7*, Microsoft Windows Vista*, Microsoft Windows* XP Professional/Windows* XP Home, and disabling Hyper-Threading Technology via the BIOS for all previous versions of Windows operating systems. For more information on Hyper-Threading Technology, see <http://www.intel.com/technology/platform-technology/hyper-threading/>.

4.3 Intel® Advanced Vector Extensions (Intel® AVX)

Intel® Advanced Vector Extensions (Intel® AVX) is the latest expansion of the Intel instruction set. It extends the Intel® Streaming SIMD Extensions (SSE) from 128-bit vectors into 256-bit vectors. Intel® AVX addresses the continued need for vector floating-point performance in mainstream scientific and engineering numerical applications, visual processing, recognition, data-mining/synthesis, gaming, physics, cryptography and other areas of applications. The enhancement in Intel® AVX allows for improved performance due to wider vectors, new extensible syntax, and rich functionality including the ability to better manage, rearrange, and sort data. For more information on Intel® AVX, see <http://www.intel.com/software/avx>.

4.4 Intel® Advanced Encryption Standard New Instructions (Intel® AES-NI)

The processor supports Advanced Encryption Standard New Instructions (Intel® AES-NI), which are a set of Single Instruction Multiple Data (SIMD) instructions that enable fast and secure data encryption and decryption based on the Advanced Encryption Standard (AES). Intel® AES-NI are valuable for a wide range of cryptographic applications, for example: applications that perform bulk encryption/decryption, authentication, random number generation, and authenticated encryption. AES is broadly accepted as the standard for both government and industry applications, and is widely deployed in various protocols.

Intel® AES-NI consists of six Intel® SSE instructions. Four instructions, namely AESENC, AESENCLAST, AESDEC, and AESDELAST facilitate high performance AES encryption and decryption. The other two, namely AESIMC and AESKEYGENASSIST, support the AES key expansion procedure. Together, these instructions provide a full hardware for support AES, offering security, high performance, and a great deal of flexibility.

4.4.1 PCLMULQDQ Instruction

The processor supports the carry-less multiplication instruction, PCLMULQDQ. PCLMULQDQ is a Single Instruction Multiple Data (SIMD) instruction that computes the 128-bit carry-less multiplication of two, 64-bit operands without generating and propagating carries. Carry-less multiplication is an essential processing component of several cryptographic systems and standards. Hence, accelerating carry-less multiplication can significantly contribute to achieving high speed secure computing and communication.

4.5 Intel® 64 Architecture x2APIC

The x2APIC architecture extends the xAPIC architecture which provides key mechanism for interrupt delivery. This extension is intended primarily to increase processor addressability.

Specifically, x2APIC:

- Retains all key elements of compatibility to the xAPIC architecture:
 - delivery modes
 - interrupt and processor priorities
 - interrupt sources
 - interrupt destination types
- Provides extensions to scale processor addressability for both the logical and physical destination modes.
- Adds new features to enhance performance of interrupt delivery.
- Reduces complexity of logical destination mode interrupt delivery on link based architectures.

The key enhancements provided by the x2APIC architecture over xAPIC are the following:

- Support for two modes of operation to provide backward compatibility and extensibility for future platform innovations.
 - In xAPIC compatibility mode, APIC registers are accessed through memory mapped interface to a 4K-Byte page, identical to the xAPIC architecture.



- In x2APIC mode, APIC registers are accessed through Model Specific Register (MSR) interfaces. In this mode, the x2APIC architecture provides significantly increased processor addressability and some enhancements on interrupt delivery.
- Increased range of processor addressability in x2APIC mode:
 - Physical xAPIC ID field increases from 8 bits to 32 bits, allowing for interrupt processor addressability up to 4G-1 processors in physical destination mode. A processor implementation of x2APIC architecture can support fewer than 32-bits in a software transparent fashion.
 - Logical xAPIC ID field increases from 8 bits to 32 bits. The 32-bit logical x2APIC ID is partitioned into two sub-fields: a 16-bit cluster ID and a 16-bit logical ID within the cluster. Consequently, $(2^{20} - 16)$ processors can be addressed in logical destination mode. Processor implementations can support fewer than 16 bits in the cluster ID sub-field and logical ID sub-field in a software agnostic fashion.
- More efficient MSR interface to access APIC registers.
 - To enhance inter-processor and self directed interrupt delivery as well as the ability to virtualize the local APIC, the APIC register set can be accessed only through MSR based interfaces in the x2APIC mode. The Memory Mapped IO (MMIO) interface used by xAPIC is not supported in the x2APIC mode.
- The semantics for accessing APIC registers have been revised to simplify the programming of frequently-used APIC registers by system software. Specifically the software semantics for using the Interrupt Command Register (ICR) and End Of Interrupt (EOI) registers have been modified to allow for more efficient delivery and dispatching of interrupts.

The x2APIC extensions are made available to system software by enabling the local x2APIC unit in the “x2APIC” mode. In order to benefit from x2APIC capabilities, a new Operating System and a new BIOS are both needed, with special support for the x2APIC mode.

The x2APIC architecture provides backward compatibility to the xAPIC architecture and forward extendibility for future Intel platform innovations.

Note: Intel x2APIC technology may not be available on all SKUs.

For more information see the Intel® 64 Architecture x2APIC specification at <http://www.intel.com/products/processor/manuals/>







5.0 Processor SKUs

5.1 Overview

This section details the features of the various SKUs of the *Intel® Xeon® and Intel® Core™ Processors for Communications Infrastructure*. The mix of SKUs are chosen to span cost, performance, temperature environment and power consumption.

5.1.1 SKU Features

Table 5-1 outlines the processor SKUs available.

Table 5-1. Base Features by SKU

<i>Intel® Xeon® and Intel® Core™ Processors for Communications Infrastructure</i>					
Product Name	Intel® Xeon® Processor E3-1125C	Intel® Xeon® Processor E3-1105C	Intel® Core™ i3 Processor 2115C	Intel® Pentium® Processor B915C	Intel® Celeron® Processor 725C
Target Core Speed (GHz)	2.0	1.0	2.0	1.5	1.3
Active Cores	4	4	2	2	1
TDP ¹ (Watts)	40	25	25	15	10
Die Type	4 Core	4 Core	2 Core	2 Core	2 Core
L3 Cache (MB)	8	6	3	3	1.5
Memory Channels	2	2	2	2	1
ECC Memory	Yes				
PCI-Express* (lanes)	20				16
PCI-Express* (root)	1x16 +1x4 or 2x8 +1x4 or 1x8 +3x4				1x16 or 2x8 or 1x8 +2x4
Junction Temperature	T _{J-Min} = 0°C, T _{J-MAX} = 100°C				
Intel® Virtualization Technology	Yes				
Intel® Hyper-Threading Technology	Yes				
Intel® Trusted Execution Technology	No				
Graphics	No				
Intel® Turbo Boost	No				

Note:

1. Thermal Design Power (TDP) is a system design target associated with the maximum component operating temperature specifications. TDP values are determined based on typical DC electrical specification and maximum component temperature for a realistic-case application running at maximum utilization.







6.0 Power Management

This chapter provides information on the following power management topics:

- ACPI States
- Processor Core
- Integrated Memory Controller (IMC)
- PCI Express*
- Direct Media Interface (DMI)

Figure 6-1. Power States

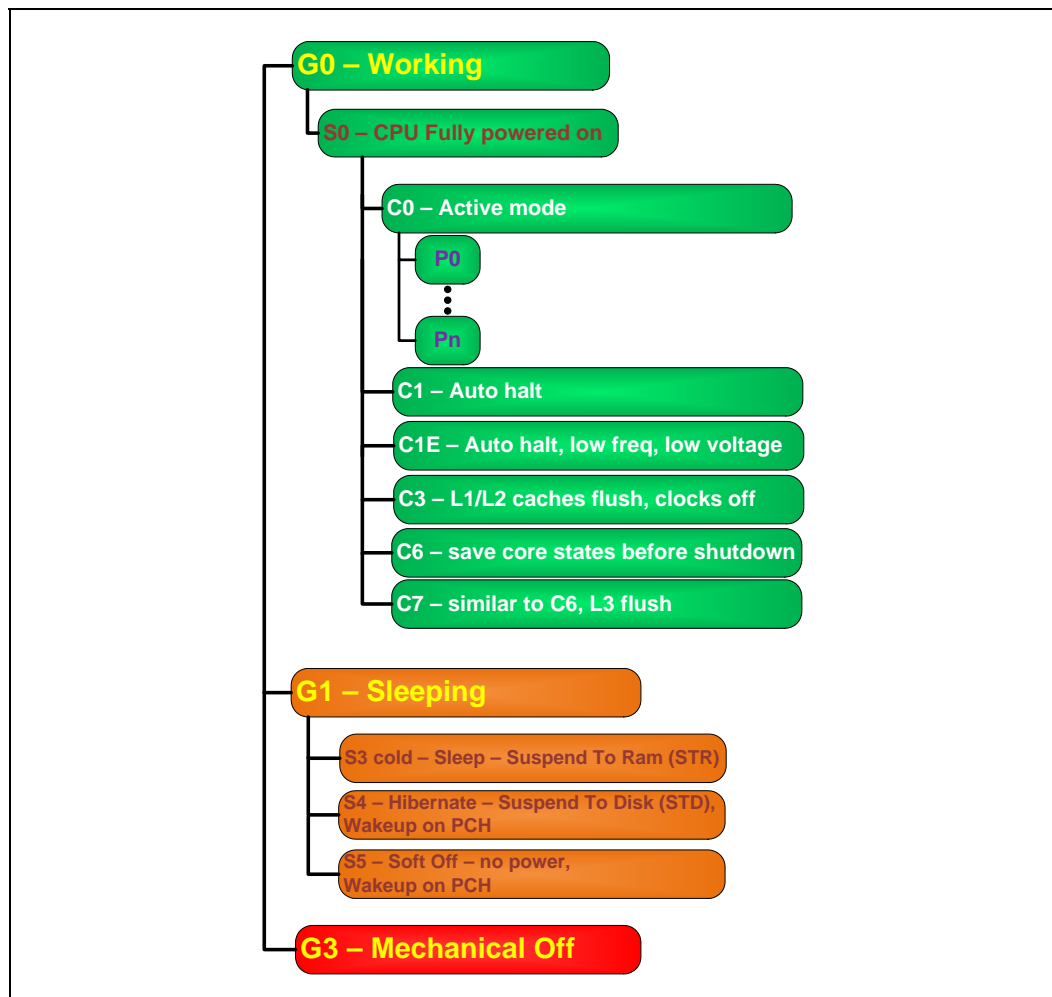



6.1 ACPI States Supported

The ACPI states supported by the processor are described in this section.

6.1.1 System States

Table 6-1. System States

State	Description
G0/S0	Full On
G1/S3-Cold	Suspend-to-RAM (STR). Context saved to memory (S3-Hot is not supported by the processor).
G1/S4	Suspend-to-Disk (STD). All power lost (except wakeup on PCH).
G2/S5	Soft off. All power lost (except wakeup on PCH). Total reboot.
G3	Mechanical off. All power (AC and battery) removed from system.

6.1.2 Processor Core/Package Idle States

Table 6-2. Processor Core/Package State Support

State	Description
C0	Active mode, processor executing code.
C1	AutoHALT state.
C1E	AutoHALT state with lowest frequency and voltage operating point.
C3	Execution cores in C3 flush their L1 instruction cache, L1 data cache, and L2 cache to the L3 shared cache. Clocks are shut off to each core.
C6	Execution cores in this state save their architectural state before removing core voltage.

6.1.3 Integrated Memory Controller States

Table 6-3. Integrated Memory Controller States

State	Description
Power up	CKE asserted. Active mode.
Pre-charge Power-down	CKE deasserted (not self-refresh) with all banks closed.
Active Power-down	CKE deasserted (not self-refresh) with minimum one bank active.
Self-Refresh	CKE deasserted using device self-refresh.



6.1.4 PCIe* Link States

Table 6-4. PCIe* Link States

State	Description
L0	Full on – Active transfer state.
L0s	First Active Power Management low power state – Low exit latency.
L1	Lowest Active Power Management - Longer exit latency.
L3	Lowest power state (power-off) – Longest exit latency.

6.1.5 DMI States

Table 6-5. DMI States

State	Description
L0	Full on – Active transfer state.
L0s	First Active Power Management low power state – Low exit latency.
L1	Lowest Active Power Management - Longer exit latency.
L3	Lowest power state (power-off) – Longest exit latency.

6.1.6 Interface State Combinations

Table 6-6. G, S and C State Combinations

Global (G) State	Sleep (S) State	Processor Core (C) State	Processor State	System Clocks	Description
G0	S0	C0	Full On	On	Full On
G0	S0	C1/C1E	Auto-Halt	On	Auto-Halt
G0	S0	C3	Deep Sleep	On	Deep Sleep
G0	S0	C6/C7	Deep Power-down	On	Deep Power Down
G1	S3	Power off		Off, except RTC	Suspend to RAM
G1	S4	Power off		Off, except RTC	Suspend to Disk
G2	S5	Power off		Off, except RTC	Soft Off
G3	NA	Power off		Power off	Hard off

6.2 Processor Core Power Management

While executing code, Enhanced Intel SpeedStep® Technology optimizes the processor's frequency and core voltage based on workload. Each frequency and voltage operating point is defined by ACPI as a P-state. When the processor is not executing code, it is idle. A low-power idle state is defined by ACPI as a C-state. In general, lower power C-states have longer entry and exit latencies.

6.2.1 Enhanced Intel SpeedStep® Technology

The following are the key features of Enhanced Intel SpeedStep Technology:

- Multiple frequency and voltage points for optimal performance and power efficiency. These operating points are known as P-states.
- Frequency selection is software controlled by writing to processor MSRs. The voltage is optimized based on the selected frequency and the number of active processor cores.
 - If the target frequency is higher than the current frequency, V_{CC} is ramped up in steps to an optimized voltage. This voltage is signaled by the SVID bus to the voltage regulator. Once the voltage is established, the PLL locks on to the target frequency.
 - If the target frequency is lower than the current frequency, the PLL locks to the target frequency, then transitions to a lower voltage by signaling the target voltage on the SVID bus.
 - All active processor cores share the same frequency and voltage. In a multi-core processor, the highest frequency P-state requested amongst all active cores is selected.
 - Software-requested transitions are accepted at any time. If a previous transition is in progress, the new transition is deferred until the previous transition is completed.
- The processor controls voltage ramp rates internally to ensure glitch-free transitions.
- Because there is low transition latency between P-states, a significant number of transitions per-second are possible.

6.2.2 Low-Power Idle States

When the processor is idle, low-power idle states (C-states) are used to save power. More power savings actions are taken for numerically higher C-states. However, higher C-states have longer exit and entry latencies. Resolution of C-states occur at the thread, processor core, and processor package level. Thread-level C-states are available if Intel Hyper-Threading Technology is enabled.

Note: Long term reliability cannot be assured unless all the Low Power Idle States are enabled.

Figure 6-2. Idle Power Management Breakdown of the Processor Cores

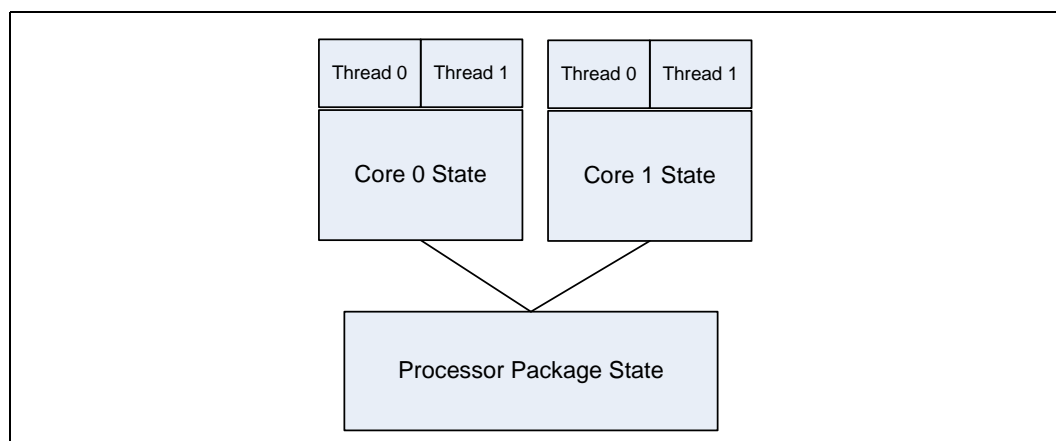



Entry and exit of the C-States at the thread and core level are shown in Figure 6-3.

Figure 6-3. Thread and Core C-State Entry and Exit

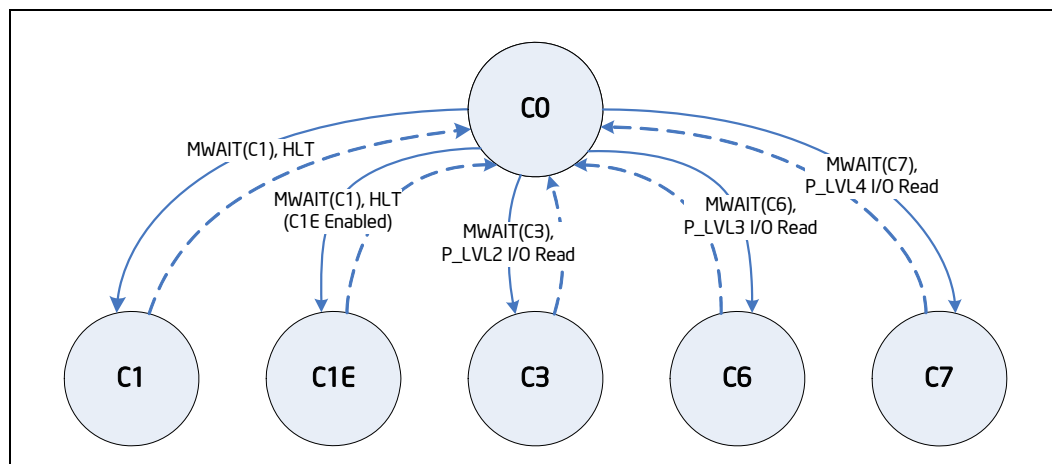

While individual threads can request low power C-states, power saving actions only take place once the core C-state is resolved. Core C-states are automatically resolved by the processor. For thread and core C-states, a transition to and from C0 is required before entering any other C-state.

Table 6-7. Coordination of Thread Power States at the Core Level

Processor Core C-State		Thread 1				
		C0	C1	C3	C6	C7
Thread 0	C0	C0	C0	C0	C0	C0
	C1	C0	C1 ¹	C1 ¹	C1 ¹	C1 ¹
	C3	C0	C1 ¹	C3	C3	C3
	C6	C0	C1 ¹	C3	C6	C6
	C7	C0	C1 ¹	C3	C6	C7

1. If enabled, the core C-state will be C1E if all actives cores have also resolved a core C1 state or higher.

6.2.3 Requesting Low-Power Idle States

The primary software interfaces for requesting low power idle states are through the MWAIT instruction with sub-state hints and the HLT instruction (for C1 and C1E). However, software may make C-state requests using the legacy method of I/O reads from the ACPI-defined processor clock control registers, referred to as P_LVLx. This method of requesting C-states provides legacy support for operating systems that initiate C-state transitions via I/O reads.

For legacy operating systems, P_LVLx I/O reads are converted within the processor to the equivalent MWAIT C-state request. Therefore, P_LVLx reads do not directly result in I/O reads to the system. The feature, known as I/O MWAIT redirection, must be enabled in the BIOS.

Note: The P_LVLx I/O Monitor address needs to be set up before using the P_LVLx I/O read interface. Each P_LVLx is mapped to the supported MWAIT(Cx) instruction as follows.



Table 6-8. P_LVLx to MWAIT Conversion

P_LVLx	MWAIT(Cx)	Notes
P_LVL2	MWAIT(C3)	The P_LVL2 base address is defined in the PMG_IO_CAPTURE MSR.
P_LVL3	MWAIT(C6)	C6. No sub-states allowed.
P_LVL4	MWAIT(C7)	C7. No sub-states allowed.
P_LVL5+	MWAIT(C7)	C7. No sub-states allowed.

The BIOS can write to the C-state range field of the PMG_IO_CAPTURE MSR to restrict the range of I/O addresses that are trapped and emulate MWAIT like functionality. Any P_LVLx reads outside of this range does not cause an I/O redirection to MWAIT(Cx) like request. They fall through like a normal I/O instruction.

Note: When P_LVLx I/O instructions are used, MWAIT substates cannot be defined. The MWAIT substate is always zero if I/O MWAIT redirection is used. By default, P_LVLx I/O redirections enable the MWAIT 'break on EFLAGS.IF' feature which triggers a wakeup on an interrupt even if interrupts are masked by EFLAGS.IF.

6.2.4 Core C-states

The following are general rules for all core C-states, unless specified otherwise:

- A core C-State is determined by the lowest numerical thread state (e.g., Thread 0 requests C1E while Thread 1 requests C3, resulting in a core C1E state). See [Table 6-6, "G, S and C State Combinations"](#).
- A core transitions to C0 state when:
 - An interrupt occurs
 - There is an access to the monitored address if the state was entered via an MWAIT instruction
- For core C1/C1E, and core C3, and core C6/C7, an interrupt directed toward a single thread wakes only that thread. However, since both threads are no longer at the same core C-state, the core resolves to C0.
- A system reset re-initializes all processor cores.

6.2.4.1 Core C0 State

The normal operating state of a core where code is being executed.

6.2.4.2 Core C1/C1E State

C1/C1E is a low power state entered when all threads within a core execute a HLT or MWAIT(C1/C1E) instruction.

A System Management Interrupt (SMI) handler returns execution to either Normal state or the C1/C1E state. See the Intel® 64 and IA-32 Architecture Software Developer's Manual, Volume 3A/3B: System Programmer's Guide for more information.

While a core is in C1/C1E state, it processes bus snoops and snoops from other threads. For more information on C1E, see [Section 6.2.5.2, "Package C1/C1E"](#).



6.2.4.3 Core C3 State

Individual threads of a core can enter the C3 state by initiating a P_LVL2 I/O read to the P_BLK or an MWAIT(C3) instruction. A core in C3 state flushes the contents of its L1 instruction cache, L1 data cache, and L2 cache to the shared L3 cache, while maintaining its architectural state. All core clocks are stopped at this point. Because the core's caches are flushed, the processor does not wake any core that is in the C3 state when either a snoop is detected or when another core accesses cacheable memory.

6.2.4.4 Core C6 State

Individual threads of a core can enter the C6 state by initiating a P_LVL3 I/O read or an MWAIT(C6) instruction. Before entering core C6, the core will save its architectural state to a dedicated SRAM. Once complete, a core will have its voltage reduced to zero volts. During exit, the core is powered on and its architectural state is restored.

6.2.4.5 Core C7 State

Individual threads of a core can enter the C7 state by initiating a P_LVL4 I/O read to the P_BLK or by an MWAIT(C7) instruction. The core C7 state exhibits the same behavior as the core C6 state unless the core is the last one in the package to enter the C7 state. If it is, that core is responsible for flushing L3 cache ways. The processor supports the C7s substate. When an MWAIT(C7) command is issued with a C7s sub-state hint, the entire L3 cache is flushed one step as opposed to flushing the L3 cache in multiple steps.

Note: Core C7 State support is available for Quad and Dual Core processors. Single Core processors do not support Core C7 State.

6.2.4.6 C-State Auto-Demotion

In general, deeper C-states such as C6 or C7 have long latencies and have higher energy entry/exit costs. The resulting performance and energy penalties become significant when the entry/exit frequency of a deeper C-state is high. Therefore incorrect or inefficient usage of deeper C-states have a negative impact on power. In order to increase residency and improve power in deeper C-states, the processor supports C-state auto-demotion.

There are two C-State auto-demotion options:

- C6/C7 to C3
- C7/C6/C3 To C1

The decision to demote a core from C6/C7 to C3 or C3/C6/C7 to C1 is based on each core's immediate residency history. Upon each core C6/C7 request, the core C-state is demoted to C3 or C1 until a sufficient amount of residency has been established. At that point, a core is allowed to go into C3/C6 or C7. Each option can be run concurrently or individually.

This feature is disabled by default. BIOS must enable it in the PMG_CST_CONFIG_CONTROL register. The auto-demotion policy is also configured by this register.

6.2.5 Package C-States

The processor supports C0, C1/C1E, C3, C6, and C7 power states. The following is a summary of the general rules for package C-state entry. These apply to all package C-states unless specified otherwise:



- A package C-state request is determined by the lowest numerical core C-state amongst all cores.
- A package C-state is automatically resolved by the processor depending on the core idle power states and the status of the platform components.
 - Each core can be at a lower idle power state than the package if the platform does not grant the processor permission to enter a requested package C-state.
 - The platform may allow additional power savings to be realized in the processor.
 - For package C-states, the processor is not required to enter C0 before entering any other C-state.

The processor exits a package C-state when a break event is detected. Depending on the type of break event, the processor does the following:

- If a core break event is received, the target core is activated and the break event message is forwarded to the target core.
 - If the break event is not masked, the target core enters the core C0 state and the processor enters package C0.
 - If the break event is masked, the processor attempts to re-enter its previous package state.
- If the break event was due to a memory access or snoop request.
 - But the platform did not request to keep the processor in a higher package C-state, the package returns to its previous C-state.
 - And the platform requests a higher power C-state, the memory access or snoop request is serviced and the package remains in the higher power C-state.

Table 6-9 shows package C-state resolution for a dual-core processor. Figure 6-4 summarizes package C-state transitions.

Table 6-9. Coordination of Core Power States at the Package Level

Package C-State		Core 1				
		C0	C1	C3	C6	C7
Core 0	C0	C0	C0	C0	C0	C0
	C1	C0	C1 ¹	C1 ¹	C1 ¹	C1 ¹
	C3	C0	C1 ¹	C3	C3	C3
	C6	C0	C1 ¹	C3	C6	C6
	C7	C0	C1 ¹	C3	C6	C7

Notes:

1. If enabled, the package C-state will be C1E if all active cores have also resolved a core C1 state or higher.



Figure 6-4. Package C-State Entry and Exit

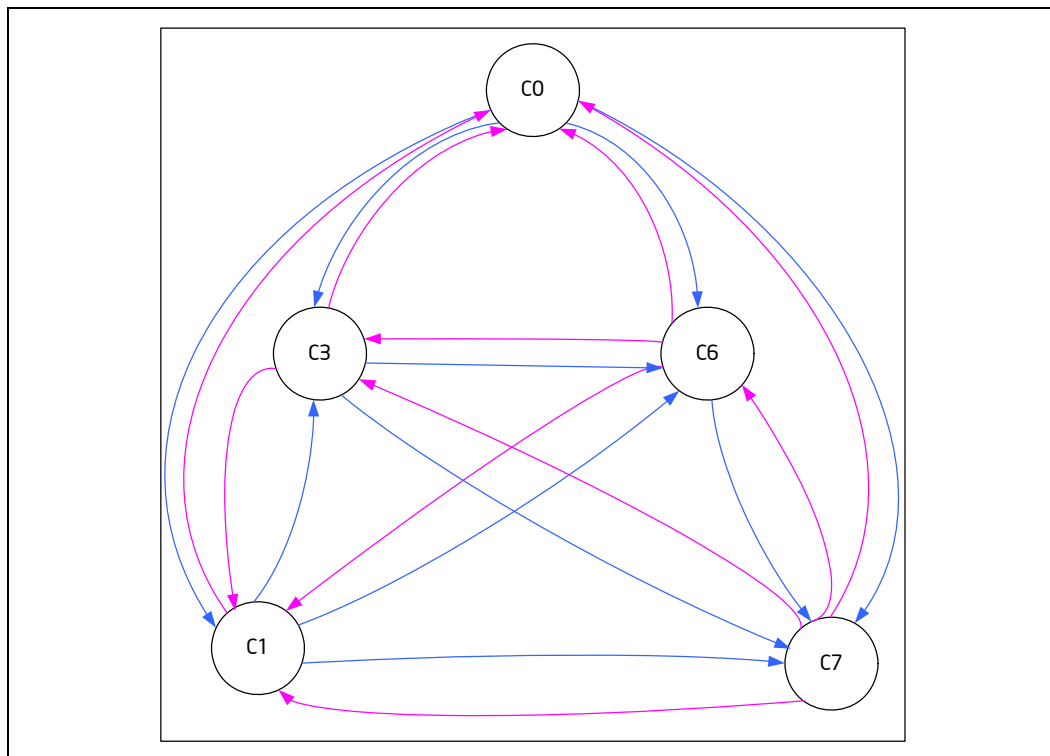

6.2.5.1 Package C0

The normal operating state for the processor. The processor remains in the normal state when at least one of its cores is in the C0 or C1 state or when the platform has not granted permission to the processor to go into a low power state. Individual cores may be in lower power idle states while the package is in C0.

6.2.5.2 Package C1/C1E

No additional power reduction actions are taken in the package C1 state. However, if the C1E sub-state is enabled, the processor automatically transitions to the lowest supported core clock frequency, followed by a reduction in voltage.

The package enters the C1 low power state when:

- At least one core is in the C1 state.
- The other cores are in a C1 or lower power state.

The package enters the C1E state when:

- All cores have directly requested C1E via MWAIT(C1) with a C1E sub-state hint.
- All cores are in a power state lower than C1/C1E but the package low power state is limited to C1/C1E via the PMG_CST_CONFIG_CONTROL MSR.
- All cores have requested C1 using HLT or MWAIT(C1) and C1E auto-promotion is enabled in IA32_MISC_ENABLES.

No notification to the system occurs upon entry to C1/C1E.



6.2.5.3 Package C3 State

A processor enters the package C3 low power state when:

- At least one core is in the C3 state.
- The other cores are in a C3 or lower power state, and the processor has been granted permission by the platform.
- The platform has not granted a request to a package C6/C7 state but has allowed a package C6 state.

In package C3-state, the L3 shared cache is snoopable.

6.2.5.4 Package C6 State

A processor enters the package C6 low power state when:

- At least one core is in the C6 state.
- The other cores are in a C6 or lower power state, and the processor has been granted permission by the platform.
- The platform has not granted a package C7 request but has allowed a C6 package state.

In package C6 state, all cores have saved their architectural state and have had their core voltages reduced to zero volts. The L3 shared cache is still powered and snoopable in this state. The processor remains in package C6 state as long as any part of the L3 cache is active.

6.2.5.5 Package C7 State

The processor enters the package C7 low power state when all cores are in the C7 state and the L3 cache is completely flushed. The last core to enter the C7 state begins to shrink the L3 cache by N-ways until the entire L3 cache has been emptied. This allows further power savings.

Core break events are handled the same way as in package C3 or C6. However, snoops are not sent to the processor in package C7 state because the platform, by granting the package C7 state, has acknowledged that the processor possesses no snoopable information. This allows the processor to remain in this low power state and maximize its power savings.

Upon exit of the package C7 state, the L3 cache is not immediately re-enabled. It re-enables once the processor has stayed out of the C6 or C7 for an preset amount of time. Power is saved since this prevents the L3 cache from being re-populated only to be immediately flushed again.

6.2.5.6 Dynamic L3 Cache Sizing

Upon entry into the package C7 state, the L3 cache is reduced by N-ways until it is completely flushed. The number of ways, N, is dynamically chosen per concurrent C7 entry. Similarly, upon exit, the L3 cache is gradually expanded based on internal heuristics.



6.3 IMC Power Management

The main memory is power managed during normal operation and in low-power ACPI Cx states.

6.3.1 Disabling Unused System Memory Outputs

Any system memory (SM) interface signal that goes to a memory module connector in which it is not connected to any actual memory devices (such as DIMM connector is unpopulated, or is single-sided) is tri-stated. The benefits of disabling unused SM signals are:

- Reduced power consumption.
- Reduced possible overshoot/undershoot signal quality issues seen by the processor I/O buffer receivers caused by reflections from potentially un-terminated transmission lines.

When a given rank is not populated, the corresponding chip select and CKE signals are not driven.

At reset, all rows must be assumed to be populated, until it can be proven that they are not populated. This is due to the fact that when CKE is tristated with an DIMM present, the DIMM is not guaranteed to maintain data integrity.

SCKE tristate should be enabled by BIOS where appropriate, since at reset all rows must be assumed to be populated.

6.3.2 DRAM Power Management and Initialization

The processor implements extensive support for power management on the SDRAM interface. There are four SDRAM operations associated with the Clock Enable (CKE) signals, which the SDRAM controller supports. The processor drives four CKE pins to perform these operations.

The CKE is one of the power-save means. When CKE is off the internal DDR clock is disabled and the DDR power is reduced. The power-saving differs according to the selected mode and the DDR type used. For more information, see the IDD table in the DDR specification.

The DDR specification defines 3 levels of power-down that differ in power-saving and in wakeup time:

1. Active power-down (APD): This mode is entered if there are open pages when deasserting CKE. In this mode the open pages are retained. Power-saving in this mode is the lowest. Power consumption of DDR is defined by IDD3P. Exiting this mode is defined by tXP – small number of cycles.
2. Precharged power-down (PPD): This mode is entered if all banks in DDR are precharged when de-asserting CKE. Power-saving in this mode is intermediate – better than APD, but less than DLL-off. Power consumption is defined by IDD2P1. Exiting this mode is defined by tXP. Difference from APD mode is that when waking-up all page-buffers are empty.
3. DLL-off: In this mode the data-in DLLs on DDR are off. Power-saving in this mode is the best among all power-modes. Power consumption is defined by IDD2P1. Exiting this mode is defined by tXP, but also tXPDLL (10 – 20 according to DDR type) cycles until first data transfer is allowed.

The processor supports 6 different types of power-down. These different modes are the power-down modes supported by DDR3 and combinations of these modes. The type of CKE power-down is defined by the configuration. The options are:



1. No power-down.
2. APD: The rank enters power-down as soon as idle-timer expires, no matter what is the bank status.
3. PPD: When idle timer expires the MC sends PRE-all to rank and then enters powerdown.
4. DLL-off: same as option (2) but DDR is configured to DLL-off.
5. APD, change to PPD (APD-PPD): Begins as option (1), and when all page-close timers of the rank are expired, it wakes the rank, issues PRE-all, and returns to PPD.
6. APD, change to DLL-off (APD_DLLoff) – Begins as option (1), and when all page-close timers of the rank are expired, it wakes the rank, issues PRE-all and returns to DLL-off power-down.

The CKE is determined per rank when it is inactive. Each rank has an idle-counter. The idle-counter starts counting as soon as the rank has no accesses, and if it expires, the rank may enter power-down while no new transactions to the rank arrive to queues. The idle-counter begins counting at the last incoming transaction arrival.

It is important to understand that since the power-down decision is per rank, the MC can find many opportunities to power-down ranks even while running memory intensive applications, and savings are significant (may be a few watts, according to the DDR specification). This is significant when each channel is populated with more ranks.

Selection of power modes should be according to power-performance or thermal tradeoffs of a given system:

- When trying to achieve maximum performance and power or thermal consideration is not an issue: use no power-down.
- In a system that tries to minimize power-consumption, try to use the deepest power-down mode possible – DLL-off or APD_DLLoff.
- In high-performance systems with dense packaging (that is, complex thermal design) the power-down mode should be considered in order to reduce the heating and avoid DDR throttling caused by the heating.

Control of the power-mode must be controlled through the BIOS – The BIOS selects no-powerdown by default. There are knobs to change the power-down selected mode.

Another control is the idle timer expiration count. This is set through PM_PDWN_config bits 7:0 (MCHBAR + 4CB0). As this timer is set to a shorter time, the MC will have more opportunities to put DDR in power-down. The minimum recommended value for this register is 15. There is no BIOS hook to set this register. Customers who choose to change the value of this register can do it by changing the BIOS. For experiments, this register can be modified in real time if BIOS did not lock the MC registers.

Note: In APD, APD-PPD, and APD_DLL-off, there is no point in setting the idle-counter in the same range as page-close idle timer.

Another option associated with CKE power-down is the S_DLL-off. When this option is enabled, the SBR I/O slave DLLs go off when all channel ranks are in power-down. (Do **not** confuse it with the DLL-off mode in which the DDR DLLs are off). This mode requires you to define the I/O slave DLL wakeup time.



6.3.2.1 Initialization Role of CKE

During power-up, CKE is the only input to the SDRAM that has its level is recognized (other than the DDR3 reset pin) once power is applied. It must be driven LOW by the DDR controller to make sure the SDRAM components float DQ and DQS during power-up. CKE signals remain LOW (while any reset is active) until the BIOS writes to a configuration register. Using this method, CKE is guaranteed to remain inactive for much longer than the specified 200 micro-seconds after power and clocks to SDRAM devices are stable.

6.3.2.2 Dynamic Power Down Operation

Dynamic power-down of memory is employed during normal operation. Based on idle conditions, a given memory rank may be powered down. The IMC implements aggressive CKE control to dynamically put the DRAM devices in a power down state. The processor core controller can be configured to put the devices in *active power-down* (CKE deassertion with open pages) or *precharge power-down* (CKE deassertion with all pages closed). Precharge power-down provides greater power savings but has a bigger performance impact, since all pages will first be closed before putting the devices in power-down mode.

If dynamic power-down is enabled, all ranks are powered up before doing a refresh cycle and all ranks are powered down at the end of refresh.

6.3.2.3 DRAM I/O Power Management

Unused signals should be disabled to save power and reduce electromagnetic interference. This includes all signals associated with an unused memory channel. Clocks can be controlled on a per DIMM basis. Exceptions are made for per DIMM control signals such as CS#, CKE, and ODT for unpopulated DIMM slots.

The I/O buffer for an unused signal should be tri-stated (output driver disabled), the input receiver (differential sense-amp) should be disabled, and any DLL circuitry related ONLY to unused signals should be disabled. The input path must be gated to prevent spurious results due to noise on the unused signals (typically handled automatically when input receiver is disabled).

6.4 PCIe* Power Management

- Active power management support using L0s, and L1 states.
- All inputs and outputs disabled in L2/L3 Ready state.

Note: PCIe* interface does not support Hot Plug.

Note: Power impact may be observed when PCIe* link disable power management state is used.

6.5 DMI Power Management

Active power management support using L0s/L1 state.

6.6 Thermal Power Management

See [Section 7.0, "Thermal Management"](#) on page 61 for all thermal power management-related features.







7.0 Thermal Management

The thermal solution provides both the component-level and the system-level thermal management. To allow for the optimal operation and long-term reliability of Intel processor-based systems, the system/processor thermal solution should be designed so that the processor:

- Remains below the maximum junction temperature (T_{J-MAX}) specification at the maximum Thermal Design Power (TDP).
- Conforms to system constraints, such as system acoustics, system skin-temperatures, and exhaust-temperature requirements.

Caution: Thermal specifications given in this chapter are on the component and package level and apply specifically to the processor. Operating the processor outside the specified limits may result in permanent damage to the processor and potentially other components in the system.

7.1 Thermal Design Power (TDP) and Junction Temperature (T_J)

The processor TDP is the maximum sustained power that should be used for design of the processor thermal solution. TDP represents an expected maximum sustained power from realistic applications. TDP may be exceeded for short periods of time or if running a “power virus” workload.

The processor integrates multiple CPU on a single die. This may result in differences in the power distribution across the die and must be considered when designing the thermal solution. See the *2nd Generation Intel® Core™ Processor For Communications Infrastructure Thermal/Mechanical Design Guide* for more details.

7.2 Thermal and Power Specifications

The following notes apply to [Table 7-1](#) and [Table 7-2](#).

Note	Definition
1	The TDPs given are not the maximum power the processor can generate. Analysis indicates that real applications are unlikely to cause the processor to consume the theoretical maximum power dissipation for sustained periods of time.
2	The thermal solution needs to ensure that the processor temperature does not exceed the maximum junction temperature (T _{J,max}) limit, as measured by the DTS and the critical temperature bit.
3	The processor junction temperature is monitored by Digital Temperature Sensors (DTS). For DTS accuracy, see Section 7.3.1.2.1 .
4	Digital Thermal Sensor (DTS) based fan speed control is required to achieve optimal thermal performance. Intel recommends full cooling capability well before the DTS reading reaches T _{J,Max} . An example of this would be T _{J,Max} - 10°C.
5	At T _J of T _{J,max}



Table 7-1. TDP Specifications

Product Number	State	CPU Core Frequency	Thermal Design Power	Units	Notes
Intel® Xeon® Processor E3-1125C	HFM	up to 2.0 GHz	40	W	1,5
	LFM	800 MHz	22		
Intel® Xeon® Processor E3-1105C	HFM	up to 1.0 GHz	25	W	1,5
	LFM	800 MHz	22		
Intel® Core™ i3 Processor 2115C	HFM	up to 2.0 GHz	25	W	1,5
	LFM	800 MHz	13		
Intel® Pentium® Processor B915C	HFM	up to 1.5 GHz	15	W	1,5
	LFM	800 MHz	13		
Intel® Celeron® Processor 725C	HFM	up to 1.3 GHz	10	W	1,5
	LFM	800 MHz	10		

Table 7-2. Junction Temperature Specification

Product Number	Symbol	Min	Default	Max	Units	Notes
Intel® Xeon® Processor E3-1125C, Intel® Xeon® Processor E3-1105C, Intel® Core™ i3 Processor 2115C, Intel® Pentium® Processor B915C, Intel® Celeron® Processor 725C	T _J	0	-	100	C	2,3,4



7.3 Thermal Management Features

This section covers thermal management features for the processor.

7.3.1 Processor Package Thermal Features

This section covers thermal management features for the entire processor complex (including the processor core and integrated memory controller hub) and is referred to as processor package or package.

Occasionally the package operates in conditions that exceed its maximum allowable operating temperature. This can be due to internal overheating or due to overheating in the entire system. In order to protect itself and the system from thermal failure, the package is capable of reducing its power consumption and thereby its temperature to attempt to remain within normal operating limits via the Adaptive Thermal Monitor.

The Adaptive Thermal Monitor can be activated when any package temperature, monitored by a digital thermal sensor (DTS), meets or exceeds its maximum junction temperature specification (T_{J-MAX}) and asserts PROCHOT#. The thermal control circuit (TCC) can be activated prior to T_{J-MAX} by use of the TCC activation offset. The assertion of PROCHOT# activates the Thermal Control Circuit (TCC), and causes the processor core to reduce frequency and voltage adaptively. The TCC remains active as long as any package temperature exceeds its specified limit. Therefore, the Adaptive Thermal Monitor continues to reduce the package frequency and voltage until the TCC is deactivated. If properly configured, when an external device asserts PROCHOT# the thermal control circuit (TCC) causes the processor core to reduce frequency and voltage adaptively.

Note: Adaptive Thermal Monitor is always enabled.

7.3.1.1 Adaptive Thermal Monitor

The purpose of the Adaptive Thermal Monitor is to reduce processor core power consumption and temperature until it operates at or below its maximum operating temperature (according for TCC activation offset). Processor core power reduction is achieved by:

- Adjusting the operating frequency (via the core ratio multiplier) and input voltage (via the SVID bus).
- Modulating (starting and stopping) the internal processor core clocks (duty cycle).

The temperature at which the Adaptive Thermal Monitor activates the Thermal Control Circuit is factory calibrated and is not user configurable. The default value is software visible in the TEMPERATURE_TARGET (0x1A2) MSR, Bits 23:16. The Adaptive Thermal Monitor does not require any additional hardware, software drivers, or interrupt handling routines.

Note: The Adaptive Thermal Monitor is not intended as a mechanism to maintain processor TDP. The system design should provide a thermal solution that can maintain TDP within its intended usage range.

7.3.1.1.1 Frequency/Voltage Control

Upon TCC activation, the processor core attempts to dynamically reduce processor core power by lowering the frequency and voltage operating point. The operating points are automatically calculated by the processor core itself and do not require the BIOS to program them as with previous generations of Intel processors. The processor core scales the operating points so that:

- The voltage is optimized according to the temperature, the core bus ratio, and number of cores in deep C-states.
- The core power and temperature are reduced while minimizing performance degradation.

A small amount of hysteresis has been included to prevent an excessive amount of operating point transitions when the processor temperature is near its maximum operating temperature. Once the temperature has dropped below the maximum operating temperature, the operating frequency and voltage transition back to the normal system operating point. This is illustrated in Figure 7-1.

Figure 7-1. Frequency and Voltage Ordering

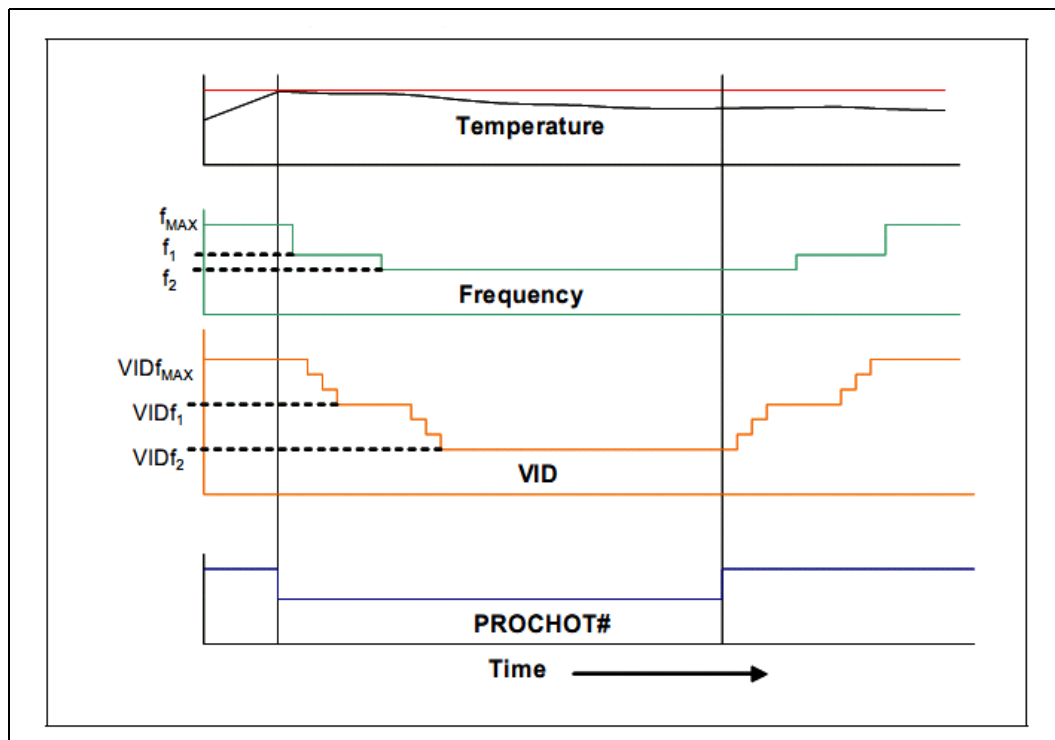

Once a target frequency/bus ratio is resolved, the processor core transitions to the new target automatically.

- On an upward operating point transition, the voltage transition precedes the frequency transition.
- On a downward transition, the frequency transition precedes the voltage transition.

When transitioning to a target core operating voltage, a new SVID code to the voltage regulator is issued. The voltage regulator must support dynamic SVID steps to support this method.

During the voltage change:

- It is necessary to transition through multiple SVID steps to reach the target operating voltage.
- Each step is 5 mV for Intel MVP-7.0 compliant VRs.
- The processor continues to execute instructions. However, the processor halts instruction execution for frequency transitions.



If a processor load-based Enhanced Intel SpeedStep Technology/P-state transition (through MSR write) is initiated while the Adaptive Thermal Monitor is active, there are two possible outcomes:

- If the P-state target frequency is higher than the processor core optimized target frequency, the p-state transition is deferred until the thermal event has been completed.
- If the P-state target frequency is lower than the processor core optimized target frequency, the processor transitions to the P-state operating point.

7.3.1.1.2 Clock Modulation

If the frequency/voltage changes are unable to end an Adaptive Thermal Monitor event, the Adaptive Thermal Monitor utilizes clock modulation. Clock modulation is done by alternately turning the clocks off and on at a duty cycle (ratio between clock "on" time and total time) specific to the processor. The duty cycle is factory configured to 25% on and 75% off and cannot be modified. The period of the duty cycle is configured to 32 microseconds when the TCC is active. Cycle times are independent of processor frequency. A small amount of hysteresis has been included to prevent excessive clock modulation when the processor temperature is near its maximum operating temperature. Once the temperature has dropped below the maximum operating temperature, and the hysteresis timer has expired, the TCC goes inactive and clock modulation ceases. Clock modulation is automatically engaged as part of the TCC activation when the frequency/voltage targets are at their minimum settings. Processor performance decreases by the same amount as the duty cycle when clock modulation is active. Snooping and interrupt processing are performed in the normal manner while the TCC is active.

7.3.1.2 Digital Thermal Sensor

Each processor execution core has an on-die Digital Thermal Sensor (DTS) which detects the core's instantaneous temperature. The DTS is the preferred method of monitoring processor die temperature because

- It is located near the hottest portions of the die.
- It can accurately track the die temperature and ensure that the Adaptive Thermal Monitor is not excessively activated.

Temperature values from the DTS can be retrieved through

- A software interface via processor Model Specific Register (MSR).
- A processor hardware interface as described in [Section 7.3.4, "Platform Environment Control Interface \(PECI\)"](#).

Note:

When temperature is retrieved by processor MSR, it is the instantaneous temperature of the given core. When temperature is retrieved via PECI, it is the average of the highest DTS temperature in the package over a 256 ms time window. Intel recommends using the PECI reported temperature for platform thermal control that benefits from averaging, such as fan speed control. The average DTS temperature may not be a good indicator of package Adaptive Thermal Monitor activation or rapid increases in temperature that triggers the Out of Specification status bit within the PACKAGE_THERM_STATUS MSR 01B1h and IA32_THERM_STATUS MSR 19Ch.

Code execution is halted in C1-C7. Therefore temperature cannot be read via the processor MSR without bringing a core back into C0. However, temperature can still be monitored through PECI in lower C-states except for C7.



Unlike traditional thermal devices, the DTS outputs a temperature relative to the maximum supported operating temperature of the processor (T_{J-MAX}), regardless of TCC activation offset. It is the responsibility of software to convert the relative temperature to an absolute temperature. The absolute reference temperature is readable in the TEMPERATURE_TARGET MSR 1A2h. The temperature returned by the DTS is an implied negative integer indicating the relative offset from T_{J-MAX}. The DTS does not report temperatures greater than T_{J-MAX}.

The DTS-relative temperature readout directly impacts the Adaptive Thermal Monitor trigger point. When a package DTS indicates that it has reached the TCC activation (a reading of 0x0, except when the TCC activation offset is changed), the TCC activates and indicates an Adaptive Thermal Monitor event. A TCC activation lowers the IA core frequency, voltage or both.

Changes to the temperature can be detected via two programmable thresholds located in the processor thermal MSRs. These thresholds have the capability of generating interrupts via the core's local APIC. See the Intel® 64 and IA-32 Architectures Software Developer's Manuals for specific register and programming details.

7.3.1.2.1 Digital Thermal Sensor Accuracy (Taccuracy)

The error associated with DTS measurement does not exceed $\pm 5^{\circ}\text{C}$ at T_{J-MAX}. The DTS measurement within the entire operating range meets a $\pm 5^{\circ}\text{C}$ accuracy.

7.3.1.3 PROCHOT# Signal

PROCHOT# (processor hot) is asserted when the processor core temperature has reached its maximum operating temperature (T_{J-MAX}). See Figure 7-1 for a timing diagram of the PROCHOT# signal assertion relative to the Adaptive Thermal Response. Only a single PROCHOT# pin exists at a package level. When any core arrives at the TCC activation point, the PROCHOT# signal is asserted. PROCHOT# assertion policies are independent of Adaptive Thermal Monitor enabling.

Note: Bus snooping and interrupt latching are active while the TCC is active.

7.3.1.3.1 Bi-Directional PROCHOT#

By default, the PROCHOT# signal is defined as an output only. However, the signal may be configured as bi-directional. When configured as a bi-directional signal, PROCHOT# can be used for thermally protecting other platform components should they overheat as well. When PROCHOT# is driven by an external device:

- The package immediately transitions to the minimum operation points (voltage and frequency) supported by the processor cores. This is contrary to the internally-generated Adaptive Thermal Monitor response.
- Clock modulation is not activated.

The TCC remains active until the system deasserts PROCHOT#. The processor can be configured to generate an interrupt upon assertion and deassertion of the PROCHOT# signal.

Note: Toggling PROCHOT# more than once in 1.5ms period results in constant Pn state of the processor.

7.3.1.3.2 Voltage Regulator Protection

PROCHOT# may be used for thermal protection of voltage regulators (VR). System designers can create a circuit to monitor the VR temperature and activate the TCC when the temperature limit of the VR is reached. By asserting PROCHOT# (pulled-low) and activating the TCC, the VR cools down as a result of reduced processor power



consumption. Bi-directional PROCHOT# can allow VR thermal designs to target thermal design current (I_{CCTDC}) instead of maximum current. Systems should still provide proper cooling for the VR and rely on bi-directional PROCHOT# only as a backup in case of system cooling failure. Overall, the system thermal design should allow the power delivery circuitry to operate within its temperature specification even while the processor is operating at its TDP.

7.3.1.3.3 Thermal Solution Design and PROCHOT# Behavior

With a properly designed and characterized thermal solution, it is anticipated that PROCHOT# is only asserted for very short periods of time when running the most power intensive applications. The processor performance impact due to these brief periods of TCC activation is expected to be so minor that it would be immeasurable.

However, an under-designed thermal solution that is not able to prevent excessive assertion of PROCHOT# in the anticipated ambient environment may:

- Cause a noticeable performance loss.
- Result in prolonged operation at or above the specified maximum junction temperature and affect the long-term reliability of the processor.
- May be incapable of cooling the processor even when the TCC is active continuously (in extreme situations).

See the *2nd Generation Intel® Core™ Processor For Communications Infrastructure Thermal/Mechanical Design Guide* for information on implementing the bi-directional PROCHOT# feature and designing a compliant thermal solution.

7.3.1.3.4 Low-Power States and PROCHOT# Behavior

If the processor enters a low-power package idle state such as C3 or C6/C7 with PROCHOT# asserted, PROCHOT# remains asserted until:

- The processor exits the low-power state
- The processor junction temperature drops below the thermal trip point.

For the package C7 state, PROCHOT# may deassert for the duration of C7 state residency even if the processor enters the idle state operating at the TCC activation temperature. The PECL interface is fully operational during all C-states and it is expected that the platform continues to manage processor ("package") core thermals even during idle states by regularly polling for thermal data over PECL.

7.3.1.3.5 THERMTRIP# Signal

Regardless of enabling the automatic or on-demand modes, in the event of a catastrophic cooling failure, the package automatically shuts down when the silicon has reached an elevated temperature that risks physical damage to the product. At this point the THERMTRIP# signal is active.

7.3.1.3.6 Critical Temperature Detection

Critical Temperature detection is performed by monitoring the package temperature. This feature is intended for graceful shutdown before the THERMTRIP# is activated, however, the processor execution is not guaranteed between critical temperature and THERMTRIP#. If the package's Adaptive Thermal Monitor is triggered and the temperature remains high, a critical temperature status and sticky bit are latched in the PACKAGE_THERM_STATUS MSR 1B1h and also generates a thermal interrupt if enabled. For more details on the interrupt mechanism, see the Intel® 64 and IA-32 Architectures Software Developer's Manuals.



7.3.2 Processor Core Specific Thermal Features

7.3.2.1 On-Demand Mode

The processor provides an auxiliary mechanism that allows system software to force the processor to reduce its power consumption via clock modulation. This mechanism is referred to as “On-Demand” mode and is distinct from Adaptive Thermal Monitor and bi-directional PROCHOT#. Processor platforms must not rely on software usage of this mechanism to limit the processor temperature. On-Demand Mode can be done via processor MSR or chipset I/O emulation.

On-Demand Mode may be used in conjunction with the Adaptive Thermal Monitor. However, if the system software tries to enable On-Demand mode at the same time the TCC is engaged, the factory configured duty cycle of the TCC overrides the duty cycle selected by the On-Demand mode. If the I/O based and MSR-based On-Demand modes are in conflict, the duty cycle selected by the I/O emulation-based On-Demand mode takes precedence over the MSR-based On-Demand Mode.

7.3.2.1.1 MSR Based On-Demand Mode

If Bit 4 of the IA32_CLOCK_MODULATION MSR is set to a 1, the processor immediately reduces its power consumption via modulation of the internal core clock, independent of the processor temperature. The duty cycle of the clock modulation is programmable via Bits 3:1 of the same IA32_CLOCK_MODULATION MSR. In this mode, the duty cycle can be programmed in either 12.5% or 6.25% increments (discoverable via CPU ID). Thermal throttling using this method modulates each processor core's clock independently.

7.3.2.1.2 I/O Emulation-Based On-Demand Mode

I/O emulation-based clock modulation provides legacy support for operating system software that initiates clock modulation through I/O writes to ACPI defined processor clock control registers on the chipset (PROC_CNT). Thermal throttling using this method modulates all processor cores simultaneously.

7.3.3 Memory Controller Specific Thermal Features

The memory controller provides the ability to initiate memory throttling based upon memory temperature. The memory temperature can be provided to the memory controller via PECCI or can be estimated by the memory controller based upon memory activity. The temperature trigger points are programmable by memory mapped IO registers.

7.3.3.1 Programmable Trip Points

This memory controller provides programmable critical, hot and warm trip points. Crossing a critical trip point forces a system shutdown. Crossing a hot or warm trip point initiates throttling. The amount of memory throttle at each trip point is programmable.

7.3.4 Platform Environment Control Interface (PECCI)

The Platform Environment Control Interface (PECCI) is a one-wire interface that provides a communication channel between Intel processor and chipset components to external monitoring devices. The processor implements a PECCI interface to allow communication of processor thermal information to other devices on the platform. The processor provides a digital thermal sensor (DTS) for fan speed control. The DTS is calibrated at the factory to provide a digital representation of relative processor temperature. Averaged DTS values are read via the PECCI interface.



The PECL physical layer is a self-clocked one-wire bus that begins each bit with a driven, rising edge from an idle level near zero volts. The duration of the signal driven high depends on whether the bit value is a Logic 0 or Logic 1. PECL also includes variable data transfer rate established with every message. The single wire interface provides low board routing overhead for the multiple load connections in the congested routing area near the processor and chipset components. Bus speed, error checking, and low protocol overhead provides adequate link bandwidth and reliability to transfer critical device operating conditions and configuration information.

7.3.4.1 Fan Speed Control with Digital Thermal Sensor

Digital Thermal Sensor based fan speed control (T_{FAN}) is a recommended feature to achieve optimal thermal performance. At the T_{FAN} temperature, Intel recommends full cooling capability well before the DTS reading reaches T_{J-MAX} . An example of this would be $T_{FAN} = T_{J, Max} - 10^{\circ}C$.

§ §





8.0 Signal Description

This chapter describes the processor signals. They are arranged in functional groups according to their associated interface or category. The following notations are used to describe the signal type:

Notations	Signal Type
I	Input Pin
O	Output Pin
I/O	Bi-directional Input/Output Pin

The signal description also includes the type of buffer used for the particular signal.

Table 8-1. Signal Description Buffer Types

Signal	Description
PCI Express*	PCI Express* interface signals. These signals are compatible with PCI Express* 2.0 Signalling Environment AC Specifications and are AC coupled. The buffers are not 3.3-V tolerant. See the PCIe* specification.
DMI	Direct Media Interface signals. These signals are compatible with PCI Express* 2.0 Signaling Environment AC Specifications, but are DC coupled. The buffers are not 3.3-V tolerant.
CMOS	CMOS buffers. 1.1-V tolerant
DDR3	DDR3 buffers: 1.5-V tolerant
A	Analog reference or output. May be used as a threshold voltage or for buffer compensation
Ref	Voltage reference signal
Asynchronous ¹	Signal has no timing relationship with any reference clock.

Notes:

1. Qualifier for a buffer type.

8.1 System Memory Interface

Table 8-2. Memory Channel A (Sheet 1 of 2)

Signal Name	Description	Direction/Buffer Type
SA_BS[2:0]	Bank Select: These signals define which banks are selected within each SDRAM rank.	O DDR3
SA_WE#	Write Enable Control Signal: Used with SA_RAS# and SA_CAS# (along with SA_CS#) to define the SDRAM Commands.	O DDR3
SA_RAS#	RAS Control Signal: Used with SA_CAS# and SA_WE# (along with SA_CS#) to define the SRAM Commands.	O DDR3



Table 8-2. Memory Channel A (Sheet 2 of 2)

Signal Name	Description	Direction/Buffer Type
SA_CAS#	CAS Control Signal: Used with SA_RAS# and SA_WE# (along with SA_CS#) to define the SRAM Commands.	O DDR3
SA_DQS[7:0] SA_DQS#[7:0]	Data Strobes: SA_DQS[7:0] and its complement signal group make up a differential strobe pair. The data is captured at the crossing point of SA_DQS[7:0] and its SA_DQS#[7:0] during read and write transactions.	I/O DDR3
SA_DQS[8] SA_DQS#[8]	Data Strobes: SA_DQS[8] is the data strobe for the ECC check data bits SA_DQ[71:64]. SA_DQS#[8] is the complement strobe for the ECC check data bits SA_DQ[71:64]. The data is captured at the crossing point of SA_DQS[8:0] and its SA_DQS#[8:0] during read and write transactions. Note: Not required for non-ECC mode	I/O DDR3
SA_DQ[63:0]	Data Bus: Channel A data signal interface to the SDRAM data bus.	I/O DDR3
SA_ECC_CB[7:0]	ECC Data Lines: Data Lines for ECC Check Byte for Channel A. Note: Not required for non-ECC mode	I/O DDR3
SA_MA[15:0]	Memory Address: These signals are used to provide the multiplexed row and column address to the SDRAM.	O DDR3
SA_CK[3:0] SA_CK#[3:0]	SDRAM Differential Clock: Channel A SDRAM Differential clock signal pair. The crossing of the positive edge of SA_CK and the negative edge of its complement SA_CK# are used to sample the command and control signals on the SDRAM.	O DDR3
SA_CKE[3:0]	Clock Enable: (1 per rank) Used to: - Initialize the SDRAMs during power-up. - Power-down SDRAM ranks. - Place all SDRAM ranks into and out of self-refresh during STR.	O DDR3
SA_CS#[3:0]	Chip Select: (1 per rank) Used to select particular SDRAM components during the active state. There is one Chip Select for each SDRAM rank.	O DDR3
SA_ODT[3:0]	On Die Termination: Active Termination Control.	O DDR3

Table 8-3. Memory Channel B (Sheet 1 of 2)

Signal Name	Description	Direction/Buffer Type
SB_BS[2:0]	Bank Select: These signals define which banks are selected within each SDRAM rank.	O DDR3
SB_WE#	Write Enable Control Signal: Used with SB_RAS# and SB_CAS# (along with SB_CS#) to define the SDRAM Commands.	O DDR3
SB_RAS#	RAS Control Signal: Used with SB_CAS# and SB_WE# (along with SB_CS#) to define the SRAM Commands.	O DDR3



Table 8-3. Memory Channel B (Sheet 2 of 2)

Signal Name	Description	Direction/Buffer Type
SB_CAS#	CAS Control Signal: Used with SB_RAS# and SB_WE# (along with SB_CS#) to define the SRAM Commands.	O DDR3
SB_DQS[7:0] SB_DQS#[7:0]	Data Strobes: SB_DQS[7:0] and its complement signal group make up a differential strobe pair. The data is captured at the crossing point of SB_DQS[7:0] and its SB_DQS#[7:0] during read and write transactions.	I/O DDR3
SB_DQS[8] SB_DQS#[8]	Data Strobes: SB_DQS[8] is the data strobe for the ECC check data bits SB_DQ[71:64]. SB_DQS#[8] is the complement strobe for the ECC check data bits SB_DQ[71:64]. The data is captured at the crossing point of SB_DQS[8:0] and its SB_DQS#[8:0] during read and write transactions. Note: Not required for non-ECC mode	I/O DDR3
SB_DQ[63:0]	Data Bus: Channel B data signal interface to the SDRAM data bus.	I/O DDR3
SB_ECC_CB[7:0]	ECC Data Lines: Data Lines for ECC Check Byte for Channel B. Note: Not required for non-ECC mode	I/O DDR3
SB_MA[15:0]	Memory Address: These signals are used to provide the multiplexed row and column address to the SDRAM.	O DDR3
SB_CK[3:0] SB_CK#[3:0]	SDRAM Differential Clock: Channel B SDRAM Differential clock signal pair. The crossing of the positive edge of SB_CK and the negative edge of its complement SB_CK# are used to sample the command and control signals on the SDRAM.	O DDR3
SB_CKE[3:0]	Clock Enable: (1 per rank) Used to: - Initialize the SDRAMs during power-up. - Power-down SDRAM ranks. - Place all SDRAM ranks into and out of self-refresh during STR.	O DDR3
SB_CS#[3:0]	Chip Select: (1 per rank) Used to select particular SDRAM components during the active state. There is one Chip Select for each SDRAM rank.	O DDR3
SB_ODT[3:0]	On Die Termination: Active Termination Control.	O DDR3



8.2 Memory Reference and Compensation

Table 8-4. Memory Reference and Compensation

Signal Name	Description	Direction/Buffer Type
SM_RCOMP[2:0]	System Memory Impedance Compensation: SM_RCOMP[0] Pull Down to VSS via 140 Ω \pm 1% SM_RCOMP[1] Pull Down to VSS via 25.5 Ω \pm 1% SM_RCOMP[2] Pull Down to VSS via 200 Ω \pm 1%	I/Analog
SM_VREF	DDR3 Reference Voltage: This provides reference voltage to the DDR3 interface and is defined as VDDQ/2	I/Analog

8.3 Reset and Miscellaneous Signals

Table 8-5. Reset and Miscellaneous Signals (Sheet 1 of 2)

Signal Name	Description	Direction/Buffer Type
CFG[17:0]	<p>Configuration Signals: The CFG signals have a default value of '1' if not terminated on the board. See the appropriate <i>Platform Design Guide</i> for pull-down recommendations when a logic low is desired.</p> <ul style="list-style-type: none"> • CFG[1:0]: Reserved configuration ball. A test point may be placed on the board for this ball. • CFG[2]: PCI Express* Static x16 Lane (Port1) Numbering Reversal. <ul style="list-style-type: none"> — 1 = Normal operation (default) — 0 = Lane numbers reversed • CFG[3]: PCI Express* Static x4 Lane (Port2) Numbering Reversal. <ul style="list-style-type: none"> — 1 = Normal operation (default) — 0 = Lane numbers reversed • CFG[4]: Reserved configuration ball. A test point may be placed on the board for this ball. • CFG[6:5]: PCI Express* Bifurcation: <ul style="list-style-type: none"> — 00 = 1 x8, 2 x4 PCI Express* — 01 = reserved — 10 = 2 x8 PCI Express* — 11 = 1 x16 PCI Express* <p>CFG[17:7]: Reserved configuration balls. A test point may be placed on the board for these balls. Note: These strap values are read upon power up and the pre-boot software enables the appropriate number of controllers and lane orientation. See Section 3.2.5, "Configuring PCIe* Lanes" and Section 3.2.6, "Lane Reversal on PCIe* Interface" for further details.</p>	I CMOS
PM_SYNC	Power Management Sync: A sideband signal to communicate power management status from the platform to the processor.	I CMOS
RESET#	Platform Reset pin driven by the PCH	I CMOS



Table 8-5. Reset and Miscellaneous Signals (Sheet 2 of 2)

Signal Name	Description	Direction/Buffer Type
SM_DRAMRST#	DDR3 DRAM Reset: Reset signal from processor to DRAM devices. One common to all channels.	O CMOS
RSVD_[21:1],RSVD_[32:23], RSVD_[43:34],RSVD_[57:45]	RESERVED: All signals in this group are RSVD pins which must be left unconnected.	No Connect
RSVD_22, RSVD_33, RSVD_44	Terminated RESERVED: These pins must be shorted together and tied to VCCP through 24.9 Ω \pm 1% resistor.	I CMOS

8.4 PCI Express* Based Interface Signals

Table 8-6. PCI Express* Interface Signals

Signal Name	Description	Direction/Buffer Type
PCIE_ICOMPI PCIE_ICOMPO PCIE_RCOMPO	PCI Express* Compensation. These pins must be shorted together and tied to VCCIO through 24.9 Ω \pm 1% resistor.	I/Analog
PCIE1_RX[15:0] PCIE1_RX#[15:0]	PCI Express* Receive Differential Pair.	I/PCI Express*
PCIE1_TX[15:0] PCIE1_TX#[15:0]	PCI Express* Transmit Differential Pair.	O/PCI Express*
PCIE2_RX[3:0] PCIE2_RX#[3:0]	PCI Express* Receive Differential Pair. x4 Port	I/PCI Express*
PCIE2_TX[3:0] PCIE2_TX#[3:0]	PCI Express* Transmit Differential Pair. x4 Port	O/PCI Express*

8.5 DMI

Table 8-7. DMI - Processor to PCH Serial Interface

Signal Name	Description	Direction/Buffer Type
DMI_RX[3:0] DMI_RX#[3:0]	DMI Input from PCH: Direct Media Interface receive differential pair.	I DMI
DMI_TX[3:0] DMI_TX#[3:0]	DMI Output to PCH: Direct Media Interface transmit differential pair.	O DMI



8.6 PLL Signals

Table 8-8. PLL Signals

Signal Name	Description	Direction/Buffer Type
BCLK BCLK#	Differential bus clock input to the processor and PCI Express*.	I Diff Clk

8.7 TAP Signals

Table 8-9. TAP Signals

Signal Name	Description	Direction/Buffer Type
BPM#[7:0]	Breakpoint and Performance Monitor Signals: Outputs from the processor that indicate the status of breakpoints and programmable counters used for monitoring processor performance.	I/O CMOS
PRDY#	PRDY# is a processor output used by debug tools to determine processor debug readiness.	O Asynchronous CMOS
PREQ#	PREQ# is used by debug tools to request debug operation of the processor.	I Asynchronous CMOS
TCK	TCK (Test Clock): Provides the clock input for the processor Test Bus (also known as the Test Access Port). TCK must be driven low or allowed to float during power on Reset.	I CMOS
TDI	TDI (Test Data In): Transfers serial test data into the processor. TDI provides the serial input needed for JTAG specification support.	I CMOS
TDO	TDO (Test Data Out) transfers serial test data out of the processor. TDO provides the serial output needed for JTAG specification support.	O Open Drain
TMS	TMS (Test Mode Select): A JTAG specification support signal used by debug tools.	I CMOS
TRST#	TRST# (Test Reset) resets the Test Access Port (TAP) logic. TRST# must be driven low during power on Reset.	I CMOS

Note:



8.8 Error and Thermal Protection

Table 8-10. Error and Thermal Protection

Signal Name	Description	Direction/Buffer Type
CATERR#	<p>Catastrophic Error: This signal indicates that the system has experienced a catastrophic error and cannot continue to operate. The processor sets this for non-recoverable machine check errors or other unrecoverable internal errors. External agents are allowed to assert this pin which causes the processor to take a machine check exception.</p> <p>On this processor, CATERR# is used for signaling the following types of errors:</p> <ul style="list-style-type: none"> Legacy MCERR's, CATERR# is asserted for 16 BCLKs. Legacy IERR's, CATERR# remains asserted until warm or cold reset. 	O CMOS
PECI	<p>PECI (Platform Environment Control Interface): A serial sideband interface to the processor, it is used primarily for thermal, power, and error management.</p>	I/O Asynchronous
PROCHOT#	<p>Processor Hot: PROCHOT# goes active when the processor temperature monitoring sensor(s) detects that the processor has reached its maximum safe operating temperature. This indicates that the processor Thermal Control Circuit (TCC) has been activated, if enabled. This signal can also be driven to the processor to activate the TCC.</p>	CMOS Input/ Open-Drain Output
THERMTRIP#	<p>Thermal Trip: The processor protects itself from catastrophic overheating by use of an internal thermal sensor. This sensor is set well above the normal operating temperature to ensure that there are no false trips. The processor stops all execution when the junction temperature exceeds approximately 130°C. This is signaled to the system by the THERMTRIP# pin. See the appropriate platform design guide for termination requirements.</p>	O Asynchronous CMOS



8.9 Power Sequencing

Table 8-11. Power Sequencing

Signal Name	Description	Direction/Buffer Type
SM_DRAMPWROK	SM_DRAMPWROK Processor Input: Connects to PCH DRAMPWROK.	I Asynchronous CMOS
UNCOREPWROGOOD	The processor requires this input signal to be a clean indication that the VCCSA, VCCIO, VAXG, and VDDQ, power supplies are stable and within specifications. This requirement applies regardless of the S-state of the processor. 'Clean' implies that the signal remains low (capable of sinking leakage current), without glitches, from the time that the power supplies are turned on until they come within specification. The signal must then transition monotonically to a high state. This is connected to the PCH PROCPWRGD signal.	I Asynchronous CMOS
PROC_DETECT#	PROC_DETECT (Processor Detect): pulled to ground on the processor package. There is no connection to the processor silicon for this signal. System board designers may use this signal to determine if the processor is present.	

8.10 Processor Power and Ground Signals

Table 8-12. Processor Power Signals

Signal Name	Description	Direction/Buffer Type
VCC	Processor core power rail.	PWR
VCCIO	Processor power for I/O	PWR
VDDQ	Processor I/O supply voltage for DDR3.	PWR
VCCPLL	VCCPLL provides isolated power for internal processor PLLs.	PWR
VCCSA	System Agent power supply	PWR
VIDSOUT VIDSCLK VIDALERT#	VIDALERT#, VIDSCLK, and VIDSCLK comprise a three signal serial synchronous interface used to transfer power management information between the processor and the voltage regulator controllers. This serial VID (SVID) interface replaces the parallel VID interface on previous processors.	I/O O I CMOS
VCCSA_VID	Voltage selection for VCCSA: This pin must have a pull down resistor to ground.	O CMOS
VSS	Processor ground node	GND



8.11 Sense Pins

Table 8-13. Sense Pins

Signal Name	Description	Direction/Buffer Type
VCC_SENSE VSS_SENSE	VCC_SENSE and VSS_SENSE provide an isolated, low impedance connection to the processor core voltage and ground. They can be used to sense or measure voltage near the silicon.	O Analog
VCCIO_SENSE VSS_SENSE_VCCIO	VCCIO_SENSE and VSS_SENSE_VCCIO provide an isolated, low impedance connection to the processor VCCIO voltage and ground. They can be used to sense or measure voltage near the silicon.	O Analog
VCCSA_VCCSENCE VCCSA_VSSSENCE	VCCSA_VCCSENCE and VCCSA_VSSSENCE provide an isolated, low impedance connection to the processor system agent voltage. It can be used to sense or measure voltage near the silicon.	O Analog

8.12 Future Compatibility

See the appropriate *Platform Design Guide* for implementation details.

Table 8-14. Future Compatibility

Signal Name	Description	Direction/Buffer Type
PROC_SELECT#	This pin is for compatibility with future platforms. A pull-up resistor to V_{CPLL} is required if connected to the DF_TVS strap on the PCH.	
SA_DIMM_VREFDQ SB_DIMM_VREFDQ	Memory Channel A/B DIMM DQ Voltage Reference: See the appropriate <i>Platform Design Guide</i> for implementation details. These signals are not used by the processor and are for future compatibility only. No connection is required.	
VCCIO_SEL	Voltage selection for VCCIO: This pin must be pulled high on the motherboard when using a dual rail voltage regulator, which will be used for future compatibility.	
VCCSA_VID[0]	Voltage selection for VCCSA: his pin must have a pull down resistor to ground.	

8.13 Processor Internal Pull Up/Pull Down

Table 8-15. Processor Internal Pull Up/Pull Down

Signal Name	Pull Up/Pull Down	Rail	Value
BPM[7:0]	Pull Up	VCCIO	65-165 Ω
PRDY#	Pull Up	VCCIO	65-165 Ω
PREQ#	Pull Up	VCCIO	65-165 Ω
TCK	Pull Down	VSS	5-15 k Ω
TDI	Pull Up	VCCIO	5-15 k Ω



Table 8-15. Processor Internal Pull Up/Pull Down

Signal Name	Pull Up/Pull Down	Rail	Value
TMS	Pull Up	VCCIO	5-15 k Ω
TRST#	Pull Up	VCCIO	5-15 k Ω
CFG[17:0]	Pull Up	VCCIO	5-15 k Ω

§ §



9.0 Electrical Specifications

9.1 Power and Ground Pins

The processor has V_{CC} , V_{CCIO} , V_{DDQ} , V_{CCPLL} , V_{CCSA} and V_{SS} (ground) inputs for on-chip power distribution. All power pins must be connected to their respective processor power planes, while all V_{SS} pins must be connected to the system ground plane. Use of multiple power and ground planes is recommended to reduce I^2R drop. The V_{CC} pins must be supplied with the voltage determined by the processor **S**erial **V**oltage **I**dentification (SVID) interface. [Table 9-1](#) specifies the voltage level for the various VIDs.

9.2 Decoupling Guidelines

Due to its large number of transistors and high internal clock speeds, the processor is capable of generating large current swings between low- and full-power states. To keep voltages within specification, output decoupling must be properly designed.

Caution: Design the board to ensure that the voltage provided to the processor remains within the specifications listed in [Table 9-5](#). Failure to do so can result in timing violations or reduced lifetime of the processor.

9.2.1 Voltage Rail Decoupling

The voltage regulator solution must:

- Provide sufficient decoupling to compensate for large current swings generated during different power mode transitions.
- Provide low parasitic resistance from the regulator to the socket.
- Meet voltage and current specifications as defined in [Table 9-5](#).



9.3 Processor Clocking (BCLK, BCLK#)

The processor utilizes a differential clock to generate the processor core(s) operating frequency, memory controller frequency, and other internal clocks. The processor core frequency is determined by multiplying the processor core ratio by 100 MHz. Clock multiplying within the processor is provided by an internal phase locked loop (PLL), which requires a constant frequency input, with exceptions for Spread Spectrum Clocking (SSC).

The processor’s maximum core frequency is configured during power-on reset by using its manufacturing default value. This value is the highest core multiplier at which the processor can operate. If lower maximum speeds are desired, the appropriate ratio can be configured via the FLEX_RATIO MSR.

9.3.1 PLL Power Supply

An on-die PLL filter solution is implemented on the processor.

9.4 Serial Voltage Identification (SVID)

The SVID specifications for the processor V_{CC} is defined in the *VR12 / IMVP7 SVID Protocol*. The processor uses three signals for the serial voltage identification interface to support automatic selection of voltages. [Table 9-1](#) specifies the voltage level corresponding to the eight bit VID value transmitted over serial VID. A ‘1’ in this table refers to a high voltage level and a ‘0’ refers to a low voltage level. If the voltage regulation circuit cannot supply the voltage that is requested, the voltage regulator must disable itself. VID signals are CMOS push/pull drivers. The VID codes change due to temperature and/or current load changes in order to minimize the power of the part. A voltage range is provided in [Table 9-1](#). The specifications are set so that one voltage regulator can operate with all supported frequencies.

Individual processor VID values may be set during manufacturing so that two devices at the same core frequency may have different default VID settings. This is shown in the VID range values in [Table 9-5](#). The processor provides the ability to operate while transitioning to an adjacent VID and its associated voltage. This represents a DC shift in the loadline.

Note: Transitions above the maximum specified VID are not permitted. [Table 9-5](#) includes VID step sizes and DC shift ranges. Minimum and maximum voltages must be maintained.

The VR utilized must be capable of regulating its output to the value defined by the new VID values issued. DC specifications for dynamic VID transitions are included in [Table 9-5](#) while AC specifications are included in [Table 9-24](#).

Table 9-1. IMVP7 Voltage Identification Definition (Sheet 1 of 8)

VID7	VID6	VID5	VID4	VID3	VID2	VID1	VID0	HEX		V _{CC_MAX}
0	0	0	0	0	0	0	0	0	0	0.00000
0	0	0	0	0	0	0	1	0	1	0.25000
0	0	0	0	0	0	1	0	0	2	0.25500
0	0	0	0	0	0	1	1	0	3	0.26000
0	0	0	0	0	1	0	0	0	4	0.26500
0	0	0	0	0	1	0	1	0	5	0.27000
0	0	0	0	0	1	1	0	0	6	0.27500
0	0	0	0	0	1	1	1	0	7	0.28000



Table 9-1. IMVP7 Voltage Identification Definition (Sheet 2 of 8)

VID7	VID6	VID5	VID4	VID3	VID2	VID1	VID0	HEX		V _{CC_MAX}
0	0	0	0	1	0	0	0	0	8	0.28500
0	0	0	0	1	0	0	1	0	9	0.29000
0	0	0	0	1	0	1	0	0	A	0.29500
0	0	0	0	1	0	1	1	0	B	0.30000
0	0	0	0	1	1	0	0	0	C	0.30500
0	0	0	0	1	1	0	1	0	D	0.31000
0	0	0	0	1	1	1	0	0	E	0.31500
0	0	0	0	1	1	1	1	0	F	0.32000
0	0	0	1	0	0	0	0	1	0	0.32500
0	0	0	1	0	0	0	1	1	1	0.33000
0	0	0	1	0	0	1	0	1	2	0.33500
0	0	0	1	0	0	1	1	1	3	0.34000
0	0	0	1	0	1	0	0	1	4	0.34500
0	0	0	1	0	1	0	1	1	5	0.35000
0	0	0	1	0	1	1	0	1	6	0.35500
0	0	0	1	0	1	1	1	1	7	0.36000
0	0	0	1	1	0	0	0	1	8	0.36500
0	0	0	1	1	0	0	1	1	9	0.37000
0	0	0	1	1	0	1	0	1	A	0.37500
0	0	0	1	1	0	1	1	1	B	0.38000
0	0	0	1	1	1	0	0	1	C	0.38500
0	0	0	1	1	1	0	1	1	D	0.39000
0	0	0	1	1	1	1	0	1	E	0.39500
0	0	0	1	1	1	1	1	1	F	0.40000
0	0	1	0	0	0	0	0	2	0	0.40500
0	0	1	0	0	0	0	1	2	1	0.41000
0	0	1	0	0	0	1	0	2	2	0.41500
0	0	1	0	0	0	1	1	2	3	0.42000
0	0	1	0	0	1	0	0	2	4	0.42500
0	0	1	0	0	1	0	1	2	5	0.43000
0	0	1	0	0	1	1	0	2	6	0.43500
0	0	1	0	0	1	1	1	2	7	0.44000
0	0	1	0	1	0	0	0	2	8	0.44500
0	0	1	0	1	0	0	1	2	9	0.45000
0	0	1	0	1	0	1	0	2	A	0.45500
0	0	1	0	1	0	1	1	2	B	0.46000
0	0	1	0	1	1	0	0	2	C	0.46500
0	0	1	0	1	1	0	1	2	D	0.47000
0	0	1	0	1	1	1	0	2	E	0.47500
0	0	1	0	1	1	1	1	2	F	0.48000



Table 9-1. IMVP7 Voltage Identification Definition (Sheet 3 of 8)

VID7	VID6	VID5	VID4	VID3	VID2	VID1	VID0	HEX		V _{CC_MAX}
0	0	1	1	0	0	0	0	3	0	0.48500
0	0	1	1	0	0	0	1	3	1	0.49000
0	0	1	1	0	0	1	0	3	2	0.49500
0	0	1	1	0	0	1	1	3	3	0.50000
0	0	1	1	0	1	0	0	3	4	0.50500
0	0	1	1	0	1	0	1	3	5	0.51000
0	0	1	1	0	1	1	0	3	6	0.51500
0	0	1	1	0	1	1	1	3	7	0.52000
0	0	1	1	1	0	0	0	3	8	0.52500
0	0	1	1	1	0	0	1	3	9	0.53000
0	0	1	1	1	0	1	0	3	A	0.53500
0	0	1	1	1	0	1	1	3	B	0.54000
0	0	1	1	1	1	0	0	3	C	0.54500
0	0	1	1	1	1	0	1	3	D	0.55000
0	0	1	1	1	1	1	0	3	E	0.55500
0	0	1	1	1	1	1	1	3	F	0.56000
0	1	0	0	0	0	0	0	4	0	0.56500
0	1	0	0	0	0	0	1	4	1	0.57000
0	1	0	0	0	0	1	0	4	2	0.57500
0	1	0	0	0	0	1	1	4	3	0.58000
0	1	0	0	0	1	0	0	4	4	0.58500
0	1	0	0	0	1	0	1	4	5	0.59000
0	1	0	0	0	1	1	0	4	6	0.59500
0	1	0	0	0	1	1	1	4	7	0.60000
0	1	0	0	1	0	0	0	4	8	0.60500
0	1	0	0	1	0	0	1	4	9	0.61000
0	1	0	0	1	0	1	0	4	A	0.61500
0	1	0	0	1	0	1	1	4	B	0.62000
0	1	0	0	1	1	0	0	4	C	0.62500
0	1	0	0	1	1	0	1	4	D	0.63000
0	1	0	0	1	1	1	0	4	E	0.63500
0	1	0	0	1	1	1	1	4	F	0.64000
0	1	0	1	0	0	0	0	5	0	0.64500
0	1	0	1	0	0	0	1	5	1	0.65000
0	1	0	1	0	0	1	0	5	2	0.65500
0	1	0	1	0	0	1	1	5	3	0.66000
0	1	0	1	0	1	0	0	5	4	0.66500
0	1	0	1	0	1	0	1	5	5	0.67000
0	1	0	1	0	1	1	0	5	6	0.67500
0	1	0	1	0	1	1	1	5	7	0.68000



Table 9-1. IMVP7 Voltage Identification Definition (Sheet 4 of 8)

VID7	VID6	VID5	VID4	VID3	VID2	VID1	VID0	HEX		V _{CC_MAX}
0	1	0	1	1	0	0	0	5	8	0.68500
0	1	0	1	1	0	0	1	5	9	0.69000
0	1	0	1	1	0	1	0	5	A	0.69500
0	1	0	1	1	0	1	1	5	B	0.70000
0	1	0	1	1	1	0	0	5	C	0.70500
0	1	0	1	1	1	0	1	5	D	0.71000
0	1	0	1	1	1	1	0	5	E	0.71500
0	1	0	1	1	1	1	1	5	F	0.72000
0	1	1	0	0	0	0	0	6	0	0.72500
0	1	1	0	0	0	0	1	6	1	0.73000
0	1	1	0	0	0	1	0	6	2	0.73500
0	1	1	0	0	0	1	1	6	3	0.74000
0	1	1	0	0	1	0	0	6	4	0.74500
0	1	1	0	0	1	0	1	6	5	0.75000
0	1	1	0	0	1	1	0	6	6	0.75500
0	1	1	0	0	1	1	1	6	7	0.76000
0	1	1	0	1	0	0	0	6	8	0.76500
0	1	1	0	1	0	0	1	6	9	0.77000
0	1	1	0	1	0	1	0	6	A	0.77500
0	1	1	0	1	0	1	1	6	B	0.78000
0	1	1	0	1	1	0	0	6	C	0.78500
0	1	1	0	1	1	0	1	6	D	0.79000
0	1	1	0	1	1	1	0	6	E	0.79500
0	1	1	0	1	1	1	1	6	F	0.80000
0	1	1	1	0	0	0	0	7	0	0.80500
0	1	1	1	0	0	0	1	7	1	0.81000
0	1	1	1	0	0	1	0	7	2	0.81500
0	1	1	1	0	0	1	1	7	3	0.82000
0	1	1	1	0	1	0	0	7	4	0.82500
0	1	1	1	0	1	0	1	7	5	0.83000
0	1	1	1	0	1	1	0	7	6	0.83500
0	1	1	1	0	1	1	1	7	7	0.84000
0	1	1	1	1	0	0	0	7	8	0.84500
0	1	1	1	1	0	0	1	7	9	0.85000
0	1	1	1	1	0	1	0	7	A	0.85500
0	1	1	1	1	0	1	1	7	B	0.86000
0	1	1	1	1	1	0	0	7	C	0.86500
0	1	1	1	1	1	0	1	7	D	0.87000
0	1	1	1	1	1	1	0	7	E	0.87500
0	1	1	1	1	1	1	1	7	F	0.88000



Table 9-1. IMVP7 Voltage Identification Definition (Sheet 5 of 8)

VID7	VID6	VID5	VID4	VID3	VID2	VID1	VID0	HEX		V _{CC_MAX}
1	0	0	0	0	0	0	0	8	0	0.88500
1	0	0	0	0	0	0	1	8	1	0.89000
1	0	0	0	0	0	1	0	8	2	0.89500
1	0	0	0	0	0	1	1	8	3	0.90000
1	0	0	0	0	1	0	0	8	4	0.90500
1	0	0	0	0	1	0	1	8	5	0.91000
1	0	0	0	0	1	1	0	8	6	0.91500
1	0	0	0	0	1	1	1	8	7	0.92000
1	0	0	0	1	0	0	0	8	8	0.92500
1	0	0	0	1	0	0	1	8	9	0.93000
1	0	0	0	1	0	1	0	8	A	0.93500
1	0	0	0	1	0	1	1	8	B	0.94000
1	0	0	0	1	1	0	0	8	C	0.94500
1	0	0	0	1	1	0	1	8	D	0.95000
1	0	0	0	1	1	1	0	8	E	0.95500
1	0	0	0	1	1	1	1	8	F	0.96000
1	0	0	1	0	0	0	0	9	0	0.96500
1	0	0	1	0	0	0	1	9	1	0.97000
1	0	0	1	0	0	1	0	9	2	0.97500
1	0	0	1	0	0	1	1	9	3	0.98000
1	0	0	1	0	1	0	0	9	4	0.98500
1	0	0	1	0	1	0	1	9	5	0.99000
1	0	0	1	0	1	1	0	9	6	0.99500
1	0	0	1	0	1	1	1	9	7	1.00000
1	0	0	1	1	0	0	0	9	8	1.00500
1	0	0	1	1	0	0	1	9	9	1.01000
1	0	0	1	1	0	1	0	9	A	1.01500
1	0	0	1	1	0	1	1	9	B	1.02000
1	0	0	1	1	1	0	0	9	C	1.02500
1	0	0	1	1	1	0	1	9	D	1.03000
1	0	0	1	1	1	1	0	9	E	1.03500
1	0	0	1	1	1	1	1	9	F	1.04000
1	0	1	0	0	0	0	0	A	0	1.04500
1	0	1	0	0	0	0	1	A	1	1.05000
1	0	1	0	0	0	1	0	A	2	1.05500
1	0	1	0	0	0	1	1	A	3	1.06000
1	0	1	0	0	1	0	0	A	4	1.06500
1	0	1	0	0	1	0	1	A	5	1.07000
1	0	1	0	0	1	1	0	A	6	1.07500
1	0	1	0	0	1	1	1	A	7	1.08000



Table 9-1. IMVP7 Voltage Identification Definition (Sheet 6 of 8)

VID7	VID6	VID5	VID4	VID3	VID2	VID1	VID0	HEX		V _{CC_MAX}
1	0	1	0	1	0	0	0	A	8	1.08500
1	0	1	0	1	0	0	1	A	9	1.09000
1	0	1	0	1	0	1	0	A	A	1.09500
1	0	1	0	1	0	1	1	A	B	1.10000
1	0	1	0	1	1	0	0	A	C	1.10500
1	0	1	0	1	1	1	0	A	D	1.11000
1	0	1	0	1	1	1	1	A	E	1.11500
1	0	1	0	1	1	1	1	A	F	1.12000
1	0	1	1	0	0	0	0	B	0	1.12500
1	0	1	1	0	0	0	1	B	1	1.13000
1	0	1	1	0	0	1	0	B	2	1.13500
1	0	1	1	0	0	1	1	B	3	1.14000
1	0	1	1	0	1	0	0	B	4	1.14500
1	0	1	1	0	1	0	1	B	5	1.15000
1	0	1	1	0	1	1	0	B	6	1.15500
1	0	1	1	0	1	1	1	B	7	1.16000
1	0	1	1	1	0	0	0	B	8	1.16500
1	0	1	1	1	0	0	1	B	9	1.17000
1	0	1	1	1	0	1	0	B	A	1.17500
1	0	1	1	1	0	1	1	B	B	1.18000
1	0	1	1	1	1	0	0	B	C	1.18500
1	0	1	1	1	1	1	0	B	D	1.19000
1	0	1	1	1	1	1	1	B	E	1.19500
1	0	1	1	1	1	1	1	B	F	1.20000
1	1	0	0	0	0	0	0	C	0	1.20500
1	1	0	0	0	0	0	1	C	1	1.21000
1	1	0	0	0	0	1	0	C	2	1.21500
1	1	0	0	0	0	1	1	C	3	1.22000
1	1	0	0	0	1	0	0	C	4	1.22500
1	1	0	0	0	1	0	1	C	5	1.23000
1	1	0	0	0	1	1	0	C	6	1.23500
1	1	0	0	0	1	1	1	C	7	1.24000
1	1	0	0	1	0	0	0	C	8	1.24500
1	1	0	0	1	0	0	1	C	9	1.25000
1	1	0	0	1	0	1	0	C	A	1.25500
1	1	0	0	1	0	1	1	C	B	1.26000
1	1	0	0	1	1	0	0	C	C	1.26500
1	1	0	0	1	1	0	1	C	D	1.27000
1	1	0	0	1	1	1	0	C	E	1.27500
1	1	0	0	1	1	1	1	C	F	1.28000



Table 9-1. IMVP7 Voltage Identification Definition (Sheet 7 of 8)

VID7	VID6	VID5	VID4	VID3	VID2	VID1	VID0	HEX		V _{CC_MAX}
1	1	0	1	0	0	0	0	D	0	1.28500
1	1	0	1	0	0	0	1	D	1	1.29000
1	1	0	1	0	0	1	0	D	2	1.29500
1	1	0	1	0	0	1	1	D	3	1.30000
1	1	0	1	0	1	0	0	D	4	1.30500
1	1	0	1	0	1	0	1	D	5	1.31000
1	1	0	1	0	1	1	0	D	6	1.31500
1	1	0	1	0	1	1	1	D	7	1.32000
1	1	0	1	1	0	0	0	D	8	1.32500
1	1	0	1	1	0	0	1	D	9	1.33000
1	1	0	1	1	0	1	0	D	A	1.33500
1	1	0	1	1	0	1	1	D	B	1.34000
1	1	0	1	1	1	0	0	D	C	1.34500
1	1	0	1	1	1	0	1	D	D	1.35000
1	1	0	1	1	1	1	0	D	E	1.35500
1	1	0	1	1	1	1	1	D	F	1.36000
1	1	1	0	0	0	0	0	E	0	1.36500
1	1	1	0	0	0	0	1	E	1	1.37000
1	1	1	0	0	0	1	0	E	2	1.37500
1	1	1	0	0	0	1	1	E	3	1.38000
1	1	1	0	0	1	0	0	E	4	1.38500
1	1	1	0	0	1	0	1	E	5	1.39000
1	1	1	0	0	1	1	0	E	6	1.39500
1	1	1	0	0	1	1	1	E	7	1.40000
1	1	1	0	1	0	0	0	E	8	1.40500
1	1	1	0	1	0	0	1	E	9	1.41000
1	1	1	0	1	0	1	0	E	A	1.41500
1	1	1	0	1	0	1	1	E	B	1.42000
1	1	1	0	1	1	0	0	E	C	1.42500
1	1	1	0	1	1	0	1	E	D	1.43000
1	1	1	0	1	1	1	0	E	E	1.43500
1	1	1	0	1	1	1	1	E	F	1.44000
1	1	1	1	0	0	0	0	F	0	1.44500
1	1	1	1	0	0	0	1	F	1	1.45000
1	1	1	1	0	0	1	0	F	2	1.45500
1	1	1	1	0	0	1	1	F	3	1.46000
1	1	1	1	0	1	0	0	F	4	1.46500
1	1	1	1	0	1	0	1	F	5	1.47000
1	1	1	1	0	1	1	0	F	6	1.47500
1	1	1	1	0	1	1	1	F	7	1.48000



Table 9-1. IMVP7 Voltage Identification Definition (Sheet 8 of 8)

VID7	VID6	VID5	VID4	VID3	VID2	VID1	VID0	HEX		V _{CC_MAX}
1	1	1	1	1	0	0	0	F	8	1.48500
1	1	1	1	1	0	0	1	F	9	1.49000
1	1	1	1	1	0	1	0	F	A	1.49500
1	1	1	1	1	0	1	1	F	B	1.50000
1	1	1	1	1	1	0	0	F	C	1.50500
1	1	1	1	1	1	1	0	F	D	1.51000
1	1	1	1	1	1	1	1	F	E	1.51500
1	1	1	1	1	1	1	1	F	F	1.52000

9.5 System Agent (SA) Vcc VID

The VccSA is configured by the processor output pin VCCSA_VID.

VCCSA_VID output default logic state is low for the processor. Logic high is reserved for future processor compatibility.

Note: During boot, VCCSA is 0.9 volts.

Table 9-2 specifies the different VCCSA_VID configurations.

Table 9-2. VCCSA_VID Configuration

VCCSA_VID	Selected VCCSA
0	0.9 V
1	0.8 V ¹

Note:

1. Some of VCCSA configurations are reserved for future Intel® processor families

9.6 Reserved or Unused Signals

The following are the general types of reserved (RSVD) signals and connection guidelines:

- RSVD_22, RSVD_33 and RSVD_44 - These pins must be shorted together and tied to VCCP through 24.9 ohm 1% resistor.
- RSVD_[21:1], RSVD_[32:23], RSVD_[43:34] and RSVD_[57:45] - these signals should not be connected.

Note: For more information regarding termination and layout guidelines, see the appropriate platform design guide.

Arbitrary connection of these signals to V_{CC} , V_{CCIO} , V_{DDQ} , V_{CCPLL} , V_{CCSA} , V_{SS} , or to any other signal (including each other) may result in component malfunction or incompatibility with future processors. See [Chapter 8.0, "Signal Description"](#) for a pin listing of the processor and the location of all reserved signals.

For reliable operation, always connect unused inputs or bi-directional signals to an appropriate signal level. Unused active high inputs should be connected through a resistor to ground (V_{SS}). Unused outputs maybe left unconnected; however, this may interfere with some Test Access Port (TAP) functions, complicate debug probing, and prevent boundary scan testing. A resistor must be used when tying bi-directional signals to power or ground. When tying any signal to power or ground, a resistor will also allow for system testability. Resistor values should be within $\pm 20\%$ of the impedance of the baseboard trace, unless otherwise noted in the appropriate platform design guidelines. For details, see [Table 8-12, "Processor Power Signals"](#).

9.7 Signal Groups

Signals are grouped by buffer type and similar characteristics as listed in [Table 9-3](#). The buffer type indicates which signaling technology and specifications apply to the signals. All the differential signals, and selected DDR3 and Control Sideband signals have On-Die Termination (ODT) resistors. Some signals do not have ODT and must be terminated on the board.

Table 9-3. Signal Groups (Sheet 1 of 3)

Signal Group ¹	Type	Signals
System Reference Clock		
Differential	CMOS Input	BCLK, BCLK#
DDR3 Reference Clocks²		
Differential	DDR3 Output	SA_CK[3:0], SA_CK#[3:0] SB_CK[3:0], SB_CK#[3:0]
DDR3 Command Signals²		
Single Ended	DDR3 Output	SA_RAS#, SB_RAS#, SA_CAS#, SB_CAS# SA_WE#, SB_WE# SA_MA[15:0], SB_MA[15:0] SA_BS[2:0], SB_BS[2:0] SM_DRAMRST# SA_CS#[3:0], SB_CS#[3:0] SA_ODT[3:0], SB_ODT[3:0] SA_CKE[3:0], SB_CKE[3:0]



Table 9-3. Signal Groups (Sheet 2 of 3)

Signal Group ¹	Type	Signals
DDR3 Data Signals²		
Single ended	DDR3 Bi-directional	SA_DQ[63:0], SB_DQ[63:0] SA_ECC_CB[7:0], SB_ECC_CB[7:0]
Differential	DDR3 Bi-directional	SA_DQS[8:0], SA_DQS#[8:0] SB_DQS[8:0], SB_DQS#[8:0]
DDR3 Compensation		
	Analog Bi-directional	SM_RCOMP[2:0]
DDR3 Reference		
	Analog Input	SM_VREF
TAP (ITP/XDP)		
Single Ended	CMOS Input	TCK, TDI, TMS, TRST#
Single Ended	CMOS Open-Drain Output	TDO
Single Ended	Asynchronous CMOS Bi-directional	BPM#[7:0]
Single Ended	Asynchronous CMOS Output	PRDY#
Single Ended	Asynchronous CMOS Input	PREQ#
Control Sideband³		
Single Ended	CMOS Input	CFG[17:0]
Single Ended	Asynchronous GTL Bi-directional	PROCHOT#
Single Ended	Asynchronous CMOS Output	THERMTRIP#, CATERR#
Single Ended	Asynchronous CMOS Input	SM_DRAMPWROK, UNCOREPWGOOD ⁴ , PM_SYNC, RESET#
Single Ended	Asynchronous Bi-directional	PECI
Voltage Regulator		
Single Ended	CMOS Input	VIDALERT#
Single Ended	Open Drain Output	VIDSCLK
Single Ended	CMOS Output	VCCSA_VID
Single Ended	Bi-directional CMOS Input/Open Drain Output	VIDSOUT
Single Ended	Analog Output	VCCSA_VCCSENSE, VCCSA_VSSSENSE,
Differential	Analog Output	VCC_SENSE, VSS_SENSE, VCCIO_SENSE, VSS_SENSE_VCCIO,
Power/Ground/Other		
Single Ended	Power	V _{CC} , V _{CCIO} , V _{CCSA} , V _{CCPLL} , V _{DDQ}
	Ground	V _{SS}
	No Connect / Test Point	RSVD
	Other	PROC_DETECT#

Table 9-3. Signal Groups (Sheet 3 of 3)

Signal Group ¹	Type	Signals
PCI Express*		
Differential	PCI Express* Input	PCIE_RX[15:0], PCIE_RX#[15:0] PE_RX[3:0], PE_RX#[3:0]
Differential	PCI Express* Output	PCIE_TX[15:0], PCIE_TX#[15:0] PE_TX[3:0], PE_TX#[3:0]
Single Ended	Analog Input	PCIE_ICOMPO, PCIE_ICOMPI, PCIE_RCOMPO
DMI		
Differential	DMI Input	DMI_RX[3:0], DMI_RX#[3:0]
Differential	DMI Output	DMI_TX[3:0], DMI_TX#[3:0]
Future Compatibility		
		PROC_SELECT#, VCCSA_VID[0], SA_DIMM_VREFDQ ² , SB_DIMM_VREFDQ ²

Notes:

1. See [Chapter 8.0](#) for signal description details.
2. SA and SB see DDR3 Channel A and DDR3 Channel B.
3. All Control Sideband Asynchronous signals are required to be asserted/deasserted for at least **10 BCLKs** with a maximum Trise/Tfall of 6 ns for the processor to recognize the proper signal state. See [Chapter 9.10](#) and [Chapter 9.11](#) for the DC and AC specifications.
4. The maximum rise/fall time of UNCOREPWRGOOD is 20 ns.

9.8 Test Access Port (TAP) Connection

Due to the voltage levels supported by other components in the Test Access Port (TAP) logic, Intel recommends the processor be first in the TAP chain, followed by any other components within the system. A translation buffer should be used to connect to the rest of the chain unless one of the other components is capable of accepting an input of the appropriate voltage. Two copies of each signal may be required with each driving a different voltage level.

The processor supports Boundary Scan (JTAG) IEEE 1149.1-2001 and IEEE 1149.6-2003 standards. Some small portion of the I/O pins may support only one of these standards.

Note: Some of the I/O pins may support only one of these standards.

9.9 Storage Conditions Specifications

Environmental storage condition limits define the temperature and relative humidity to which the device is exposed to while being stored in a moisture barrier bag. The specified storage conditions are for component level prior to board attach.

[Table 9-4](#) specifies absolute maximum and minimum storage temperature limits which represent the maximum or minimum device condition beyond which damage, latent or otherwise, may occur. The table also specifies sustained storage temperature, relative humidity, and time-duration limits. These limits specify the maximum or minimum device storage conditions for a sustained period of time. Failure to adhere to the following specifications can affect long term reliability of the processor.



Table 9-4. Storage Condition Ratings

Symbol	Parameter	Min	Max	Notes
$T_{\text{absolute storage}}$	The non-operating device storage temperature. Damage (latent or otherwise) may occur when exceeded for any length of time.	-25°C	125°C	1, 2, 3, 4
$T_{\text{sustained storage}}$	The ambient storage temperature (in shipping media) for a sustained period of time.	-5°C	40°C	5, 6
$T_{\text{short term storage}}$	The ambient storage temperature (in shipping media) for a short period of time.	-20°C	85°C	
$RH_{\text{sustained storage}}$	The maximum device storage relative humidity for a sustained period of time.	60% @ 24°C		6, 7
$\text{Time}_{\text{sustained storage}}$	A prolonged or extended period of time; typically associated with customer shelf life.	0 Months	6 Months	7
$\text{Time}_{\text{short term storage}}$	A short-period of time.	0 hours	72 hours	

Notes:

- Refers to a component device that is not assembled in a board or socket and is not electrically connected to a voltage reference or I/O signal.
- Specified temperatures are not to exceed values based on data collected. Exceptions for surface mount reflow are specified by the applicable JEDEC standard. Non-adherence may affect processor reliability.
- $T_{\text{absolute storage}}$ applies to the unassembled component only and does not apply to the shipping media, moisture barrier bags, or desiccant.
- Component product device storage temperature qualification methods may follow JESD22-A119 (low temp) and JESD22-A103 (high temp) standards when applicable for volatile memory.
- Intel® branded products are specified and certified to meet the following temperature and humidity limits that are given as an example only (Non-Operating Temperature Limit: -40°C to 70°C and Humidity: 50% to 90%, non-condensing with a maximum wet bulb of 28°C.) Post board attach storage temperature limits are not specified for non-Intel branded boards.
- The JEDEC J-JSTD-020 moisture level rating and associated handling practices apply to all moisture sensitive devices removed from the moisture barrier bag.
- Nominal temperature and humidity conditions and durations are given and tested within the constraints imposed by $T_{\text{sustained storage}}$ and customer shelf life in applicable Intel boxes and bags.

9.10 DC Specifications

The processor DC specifications in this section are defined at the processor pins, unless noted otherwise. See [Chapter 10.0](#) for the processor pin listings and [Chapter 8.0](#) for signal definitions.

The DC specifications for the DDR3 signals are listed in [Table 9-10](#). Control Sideband and Test Access Port (TAP) are listed in [Table 9-11](#).

[Table 9-5](#) through [Table 9-9](#) lists the DC specifications for the processor and are valid only while meeting specifications for junction temperature, clock frequency, and input voltages. Read all notes associated with each parameter.

AC tolerances for all DC rails include dynamic load currents at switching frequencies up to 1 MHz.



9.10.1 Voltage and Current Specifications

Note: The following specifications and parameters are based on characterized data from silicon measurements.

Table 9-5. Processor Core (VCC) DC Voltage and Current Specifications (Sheet 1 of 2)

Symbol	Parameter	Product Number	Min	Typ	Max	Unit	Note
HFM_VID	VID Range for Highest Frequency Mode	E3-1125C	0.8		1.35	V	1,2,7,9
		E3-1105C	0.8		1.35		
		i3 2115C	0.75		1.3		
		B915C	0.70		1.2		
		725C	0.70		1.2		
LFM_VID	VID Range for Lowest Frequency Mode	E3-1125C	0.65		0.95	V	1,2,9
		E3-1105C	0.65		0.95		
		i3 2115C	0.65		0.90		
		B915C	0.65		0.90		
		725C	0.65		0.90		
V _{CC}	V _{CC} for processor core		0.3-1.52			V	2, 3, 4
I _{CCMAX}	Maximum Processor Core I _{CC}	E3-1125C			57	A	5,7,9
		E3-1105C			33		
		i3 2115C			30		
		B915C			23		
		725C			10		
I _{CC_TDC}	Thermal Design I _{CC}	E3-1125C			35	A	6,7, 9
		E3-1105C			22		
		i3 2115C			18		
		B915C			13		
		725C			8		
I _{CC_LFM}	I _{CC} at LFM	E3-1125C			28	A	6
		E3-1105C			28		
		i3 2115C			15		
		B915C			15		
		725C			8		
TDC_LFM	TDC at LFM	E3-1125C			22	A	6
		E3-1105C			22		
		i3 2115C			12		
		B915C			12		
		725C			8		
I _{CC_Dyn_VID1}	Dynamic Current step size in VID1	E3-1125C			46	A	11, 12
		E3-1105C			26		
		i3 2115C			24		
		B915C			18		
		725C			8		
didt	VCC ICC Slew Time		150			nS	13
TOL _{VCC}	Voltage Tolerance	PS0			+/- 15	mV	8, 10
		PS1			+/- 12		
		PS2, PS3			+/- 11.5		



Table 9-5. Processor Core (VCC) DC Voltage and Current Specifications (Sheet 2 of 2)

Symbol	Parameter	Product Number	Min	Typ	Max	Unit	Note
Ripple	Ripple Tolerance	PS0 & I _{cc} > TDC+30%			+/- 15	mV	8, 10
		PS0 & I _{cc} <= TDC+30%			+/- 10		
		PS1			+/- 13		
		PS2			- 7.5/+18.5		
		PS3			- 7.5/+27.5		
VOvS_Max	Max Overshoot Voltage				50	mV	
tOvS_Max	Max Overshoot Time Duration				10	uS	
VR Step	VID resolution			5		mV	
SLOPE _{LL}	Processor Loadline Slope	E3-1125C E3-1105C i3 2115C B915C 725C		-1.9 -1.9 -2.9 -2.9		mΩ	

Notes:

1. These specifications have been updated with characterized data from silicon measurements.
2. Each processor is programmed with a maximum valid voltage identification value (VID), which is set at manufacturing and cannot be altered. Individual maximum SVID values are calibrated during manufacturing such that two processors at the same frequency may have different settings within the SVID range. This differs from the SVID employed by the processor during a power or thermal management event (Intel Adaptive Thermal Monitor, Enhanced Intel SpeedStep Technology, or Low Power States).
3. The voltage specification requirements are measured across V_{CC_SENSE} and V_{SS_SENSE} balls at the socket with a 100-MHz bandwidth oscilloscope, 1.5 pF maximum probe capacitance, and 1-MΩ minimum impedance. The maximum length of ground wire on the probe should be less than 5 mm. Ensure external noise from the system is not coupled into the oscilloscope probe.
4. See the Platform Design Guide for the minimum, typical, and maximum V_{CC} allowed for a given current. The processor should not be subjected to any V_{CC} and I_{CC} combination wherein V_{CC} exceeds V_{CC_MAX} for a given current.
5. Processor core VR to be designed to electrically support this current
6. Processor core VR to be designed to thermally support this current indefinitely.
7. Measured at V_{CC_SENSE} and V_{SS_SENSE} processor pins.
8. Long term reliability cannot be assured if tolerance, ripple, and core noise parameters are violated
9. Long term reliability cannot be assured in conditions above or below Max/Min functional limits.
10. PSx refers to the voltage regulator power state as set by the SVID protocol.
11. Step is done in 150 ns
12. Slew time for any transient step size.
13. Simulated at platform processor pads. This parameter is not tested.



Table 9-6. Processor Uncore (V_{CCIO}) Supply DC Voltage and Current Specifications

Symbol	Parameter	Min	Typ	Max	Unit	Note
V _{CCIO}	Voltage for the memory controller and shared cache defined at the motherboard V _{CCIO_SENSE} and V _{SS_SENSE_VCCIO}	-	1.05	-	V	
TOL _{CCIO}	V _{CCIO} Tolerance defined across V _{CCIO_SENSE} and V _{SS_SENSE_VCCIO}	DC: ±2% including ripple AC: ±3%			%	1
I _{CCMAX_VCCIO}	Max Current for V _{CCIO} Rail		-	8.5	A	1
I _{CTDC_VCCIO}	Thermal Design Current (TDC) for V _{CCIO} Rail		-	8.5	A	1
di/dt	Step current	2			A	2, 3
Slew Rate	Voltage Ramp rate (dV/dT)	0.5		10	mV/uS	1

Notes:

1. Long term reliability cannot be assured in conditions above or below Max/Min functional limits.
2. Step is done in 100nS.
3. di/dt values are for platform testing only. This parameter is not tested on Intel silicon. Testing should go up to and include IccMax.

Table 9-7. Memory Controller (V_{DDQ}) Supply DC Voltage and Current Specifications

Symbol	Parameter	Min	Typ	Max	Unit	Note
V _{DDQ} (DC+AC)	Processor I/O supply voltage for DDR3 (DC + AC specification)	-	1.5	-	V	
TOL _{DDQ}	V _{DDQ} Tolerance	DC= ±3% AC= ±2% AC+DC= ±5%			%	3
I _{CCMAX_VDDQ}	Max Current for V _{DDQ} Rail		-	5	A	1,2
I _{CCAVG_VDDQ} (Standby)	Average Current for V _{DDQ} Rail during Standby		66	133	mA	2
Slew Rate	Voltage Ramp rate (dV/dT)	0.5		10	mV/uS	
di/dt	Step current	7.5			A	3, 4

Notes:

1. The current supplied to the DIMM modules is not included in this specification.
2. Long term reliability cannot be assured in conditions above or below Max/Min functional limits.
3. Step current between 1 amp through 8.5 amps is done in 150nS
4. di/dt values are for platform testing only. This parameter is not tested on Intel silicon. Testing should go up to and include IccMax.

Table 9-8. System Agent (V_{CCSA}) Supply DC Voltage and Current Specifications

Symbol	Parameter	Min	Typ	Max	Unit	Note
V _{CCSA}	Voltage for the System Agent and V _{CCSA_VCCSENCE}	-	0.90	-	V	1
TOL _{CCSA}	V _{CCSA} Tolerance	AC+DC= ±5%			%	1
I _{CCMAX_VCCSA}	Max Current for V _{CCSA} Rail		-	6	A	1
I _{CTDC_VCCSA}	Thermal Design Current (TDC) for V _{CCSA} Rail		-	6	A	1

Table 9-8. System Agent (V_{CCSA}) Supply DC Voltage and Current Specifications

Symbol	Parameter	Min	Typ	Max	Unit	Note
Slew Rate	Voltage Ramp rate (dV/dT)	0.5		10	mV/uS	1
di/dt	Step current	2			A	2, 3

Notes:

1. Long term reliability cannot be assured in conditions above or below Max/Min functional limits.
2. Step current is done in 100nS
3. di/dt values are for platform testing only. This parameter is not tested on Intel silicon. Testing should go up to and include IccMax.

Table 9-9. Processor PLL (V_{CCPLL}) Supply DC Voltage and Current Specifications

Symbol	Parameter	Min	Typ	Max	Unit	Note
V_{CCPLL}	PLL supply voltage (DC + AC specification)	-	1.8	-	V	
TOL_{CCPLL}	V_{CCPLL} Tolerance	AC+DC= $\pm 5\%$			%	
I_{CCMAX_VCCPLL}	Max Current for V_{CCPLL} Rail		-	1.2	A	
I_{CCTDC_VCCPLL}	Thermal Design Current (TDC) for V_{CCPLL} Rail		-	1.2	A	3

Note: Long term reliability cannot be assured in conditions above or below Max/Min functional limits.

Table 9-10. DDR3 Signal Group DC Specifications (Sheet 1 of 2)

Symbol	Parameter	Min	Typ	Max	Units	Notes ¹
V_{IL}	Input Low Voltage			SM_VREF -0.1	V	2,4,10
V_{IH}	Input High Voltage	SM_VREF + 0.1			V	3,10
V_{iL}	Input Low Voltage (SM_DRAMPWROK)			$V_{DDQ} * 0.55 - 0.1$	V	9
V_{iH}	Input High Voltage (SM_DRAMPWROK)	$V_{DDQ} * 0.55 + 0.1$			V	9
V_{OL}	Output Low Voltage		$(V_{DDQ} / 2) * (R_{ON} / (R_{ON} + R_{TERM}))$			6
V_{OH}	Output High Voltage		$V_{DDQ} - ((V_{DDQ} / 2) * (R_{ON} / (R_{ON} + R_{TERM})))$		V	4,6
$R_{ON_UP(DQ)}$	DDR3 Data Buffer pull-up Resistance	23.3	28.2	32.9	Ω	5
$R_{ON_DN(DQ)}$	DDR3 Data Buffer pull-down Resistance	21.4	26.8	34.3	Ω	5
$R_{ODT(DQ)}$	DDR3 On-die termination equivalent resistance for data signals	83 41.5	100 50	117 65	Ω	
$V_{ODT(DC)}$	DDR3 On-die termination DC working point (driver set to receive mode)	$0.43 * V_{CC}$	$0.5 * V_{CC}$	$0.56 * V_{CC}$	V	
$R_{ON_UP(CK)}$	DDR3 Clock Buffer pull-up Resistance	20.8	25.8	29.2	Ω	5
$R_{ON_DN(CK)}$	DDR3 Clock Buffer pull-down Resistance	20.8	24.8	31.2	Ω	5
$R_{ON_UP(CMD)}$	DDR3 Command Buffer pull-up Resistance	15.8	20.5	23.5	Ω	5



Table 9-10. DDR3 Signal Group DC Specifications (Sheet 2 of 2)

Symbol	Parameter	Min	Typ	Max	Units	Notes ¹
R _{ON_DN(CMD)}	DDR3 Command Buffer pull-down Resistance	15.7	19.8	24.0	Ω	5
R _{ON_UP(CTL)}	DDR3 Control Buffer pull-up Resistance	14.9	20.1	23.7	Ω	5
R _{ON_DN(CTL)}	DDR3 Control Buffer pull-down Resistance	14.5	19.2	24.3	Ω	5
I _{LI}	Input Leakage Current (DQ, CK) 0V 0.2*V _{DDQ} 0.8*V _{DDQ} V _{DDQ}			± 0.75 ± 0.55 ± 0.9 ± 1.4	mA	
I _{LI}	Input Leakage Current (CMD, CTL) 0V 0.2*V _{DDQ} 0.8*V _{DDQ} V _{DDQ}			± 0.85 ± 0.65 ± 1.10 ± 1.65	mA	
SM_RCOMP0	Command COMP Resistance	138.6	140	141.4	Ω	8
SM_RCOMP1	Data COMP Resistance	25.74	26	26.26	Ω	8
SM_RCOMP2	ODT COMP Resistance	198	200	202	Ω	8

Notes:

- Unless otherwise noted, all specifications in this table apply to all processor frequencies.
- V_{IL} is defined as the maximum voltage level at a receiving agent that will be interpreted as a logical low value.
- V_{IH} is defined as the minimum voltage level at a receiving agent that will be interpreted as a logical high value.
- V_{IH} and V_{OH} may experience excursions above V_{DDQ}. However, input signal drivers must comply with the signal quality specifications.
- This is the pull up/down driver resistance. See the processor *I/O Buffer Models* for I/V characteristics.
- R_{TERM} is the termination on the DIMM and is not controlled by the Processor.
- The minimum and maximum values for these signals are programmable by BIOS to one of the two sets.
- SM_RCOMPx resistance must be provided on the system board with 1% resistors. SM_RCOMPx resistors are connected to V_{SS}.
- SM_DRAMPWROK must have a maximum of 15ns rise or fall time over V_{DDQ} * 0.55± 200mV and the edge must be monotonic.
- SM_VREF is defined as V_{DDQ}/2

Table 9-11. Control Sideband and TAP Signal Group DC Specifications

Symbol	Parameter	Min	Max	Units	Notes ¹
V _{IL}	Input Low Voltage		V _{CCIO} *0.3	V	2,3
V _{IH}	Input High Voltage	V _{CCIO} *0.7		V	2,3,5
V _{OL}	Output Low Voltage		V _{CCIO} *0.1	V	2
V _{OH}	Output High Voltage	V _{CCIO} *0.9		V	2,5
R _{ON}	Buffer on Resistance	23	73	Ω	
I _{LI}	Input Leakage Current - PROCHOT# - TDO - All other signals in this group		-0.20 to +2.00 -0.20 to +2.00 -0.20 to +0.50	mA	4

Notes:

- Unless otherwise noted, all specifications in this table apply to all processor frequencies.
- The V_{CCIO} referred to in these specifications refers to instantaneous V_{CCIO}.
- See the processor *I/O Buffer Models* for I/V characteristics.
- For V_{IN} between "0" V and V_{CCIO}. Measured when the driver is tristated.
- V_{IH} and V_{OH} may experience excursions above V_{CCIO}. However, input signal drivers must comply with the signal quality specifications.



Table 9-12. PCI Express* DC Specifications

Symbol	Parameter	Min	Typ	Max	Units	Notes ¹
$V_{TX-DIFF-p-p}$	Differential Peak-to-Peak Tx Voltage Swing	0.4	0.5	0.6	V	4
$V_{TX_CM-AC-p}$	Tx AC Peak Common Mode Output Voltage (Gen 1 Only)	0.8	1	1.2	mV	1,2,5
$Z_{TX-DIFF-DC}$	DC Differential Tx Impedance (Gen 1 Only)	80		120	Ω	1,9
Z_{RX-DC}	DC Common Mode Rx Impedance	40		60	Ω	1,7,8
$Z_{RX-DIFF-DC}$	DC Differential Rx Impedance (Gen1 Only)	80		120	Ω	1
$V_{RX-DIFFp-p}$	Differential Rx Input Peak-to-Peak Voltage (Gen 1 only)	0.175		1.2	V	1,3,10
$V_{RX_CM-AC-p}$	Rx AC Peak Common Mode Input Voltage			150	mV	1,6

Notes:

- See the *PCI Express* Base Specification* for details.
- $V_{TX-AC-CM-PP}$ and $V_{TX-AC-CM-P}$ are defined in the *PCI Express Base Specification*. Measurement is made over at least 10^6 UI.
- See [Figure 9-8, "PCI Express* Receiver Eye Margins" on page 113](#).
- As measured with compliance test load. Defined as $2 * |V_{TXD+} - V_{TXD-}|$.
- RMS value.
- Measured at Rx pins into a pair of 50- Ω terminations into ground. Common mode peak voltage is defined by the expression: $\max\{|(V_{d+} - V_{d-}) - V_{-CMDC}|\}$.
- DC impedance limits are needed to guarantee Receiver detect.
- The Rx DC Common Mode Impedance must be present when the Receiver terminations are first enabled to ensure that the Receiver Detect occurs properly. Compensation of this impedance can start immediately and the 15 Rx Common Mode Impedance (constrained by RLRX-CM to $50 \Omega \pm 20\%$) must be within the specified range by the time Detect is entered.
- Low impedance defined during signaling. Parameter is captured for 5.0 GHz by RLTX-DIFF.
- This specification is the same as V_{RX-EYE} .

9.10.2 Platform Environmental Control Interface DC Specifications

Platform Environmental Control Interface (PECI) is an Intel proprietary interface that provides a communication channel between Intel processors and chipset components to external Adaptive Thermal Monitor devices. The processor contains a Digital Thermal Sensor (DTS) that reports a relative die temperature as an offset from Thermal Control Circuit (TCC) activation temperature. Temperature sensors located throughout the die are implemented as analog-to-digital converters calibrated at the factory. PECI provides an interface for external devices to read the DTS temperature for thermal management and fan speed control.

9.10.2.1 PECI Bus Architecture

The PECI architecture is based on a wired-OR bus, which the processor PECI can pull up high (with strong drive strength). The idle state on the bus is near zero.

[Figure 9-1](#) demonstrates PECI design and connectivity. The host/originator can be a third-party PECI host, with one of the PECI clients being the processor PECI device.

Figure 9-1. Example of PECl Host-Client Connection

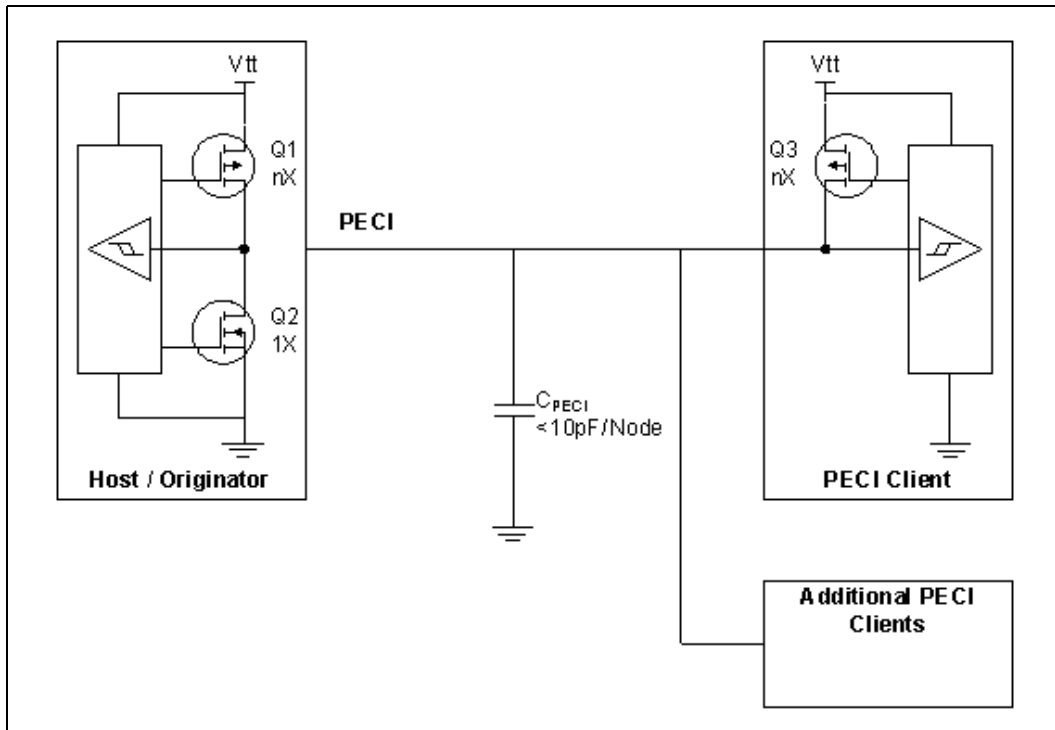

9.10.2.2 PECl DC Characteristics

The PECl interface operates at a nominal voltage set by V_{CCIO} . The set of DC electrical specifications shown in Table 9-13 are used with devices normally operating from a V_{CCIO} interface supply. V_{CCIO} nominal levels will vary between processor families. All PECl devices will operate at the V_{CCIO} level determined by the processor installed in the system.

Table 9-13. PECl DC Electrical Limits (Sheet 1 of 2)

Symbol	Definition and Conditions	Min	Max	Units	Notes ¹
R_{up}	Internal pull up resistance	15	45	Ohm	3
V_{in}	Input Voltage Range	-0.15	V_{CCIO}	V	
$V_{hysteresis}$	Hysteresis	$0.1 * V_{CCIO}$	N/A	V	
V_n	Negative-Edge Threshold Voltage	$0.275 * V_{CCIO}$	$0.500 * V_{CCIO}$	V	
V_p	Positive-Edge Threshold Voltage	$0.550 * V_{CCIO}$	$0.725 * V_{CCIO}$	V	
C_{bus}	Bus Capacitance per Node	N/A	10	pF	
C_{pad}	Pad Capacitance	0.7	1.8	pF	
$I_{leak000}$	leakage current @ 0V	-	0.6	mA	
$I_{leak025}$	leakage current @ $0.25 * V_{CCIO}$	-	0.4	mA	
$I_{leak050}$	leakage current @ $0.50 * V_{CCIO}$	-	0.2	mA	



Table 9-13. PECl DC Electrical Limits (Sheet 2 of 2)

Symbol	Definition and Conditions	Min	Max	Units	Notes ¹
Ileak075	leakage current @ 0.75*V _{CCIO}	-	0.13	mA	
Ileak100	leakage current @ V _{CCIO}	-	0.10	mA	

Notes:

1. V_{CCIO} supplies the PECl interface. PECl behavior does not affect V_{TT} min/max specifications.
2. The leakage specification applies to powered devices on the PECl bus.
3. The PECl buffer internal pull up resistance measured at 0.75*V_{CCIO}

9.10.2.3 Input Device Hysteresis

The input buffers in both client and host models must use a Schmitt-triggered input design for improved noise immunity. Use [Figure 9-2](#) as a guide for input buffer design.

Figure 9-2. Input Device Hysteresis

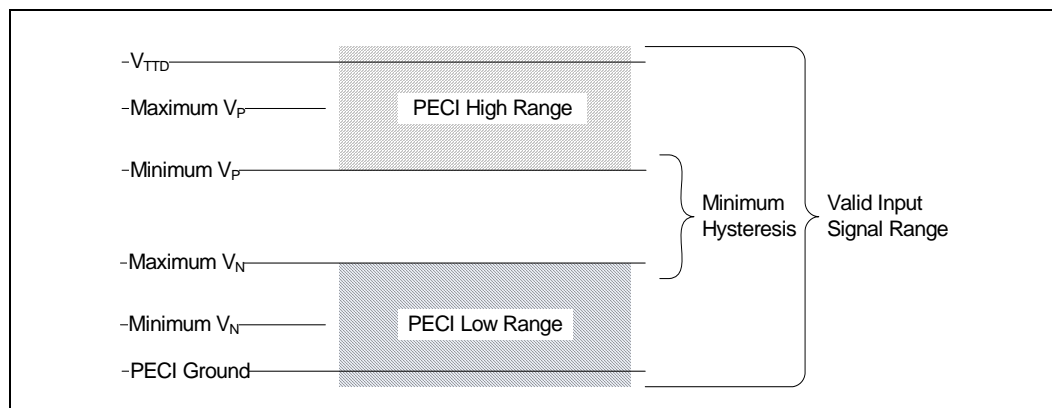

9.11 AC Specifications

The processor timings specified in this section are defined at the processor pads. Therefore, proper simulation of the signals is the only means to verify proper timing and signal quality.

See [Chapter 10.0](#) for the processor pin listings and [Chapter 8.0](#) for signal definitions. [Table 9-14](#) through [Table 9-24](#) list the AC specifications associated with the processor.

The timings specified in this section should be used in conjunction with the processor signal integrity models provided by Intel.

Note: Ensure to read all notes associated with a particular timing parameter.



Table 9-14. Differential Clocks (SSC on)

SSC ON	1CLK	1 μ s	0.1 s		0.1 s	1 μ s	1CLK	
Signal Name	-Jitter c-c Abs PerMin	-SSC Short AvgMin	-ppm Long AvgMin	Ideal DC Target	+ppm Long AvgMax	+SSC Short AvgMax	+Jitter c-c Abs PerMax	Units
BCLK	9.849063	9.999063	10.02406	10.02506	10.02607	10.05120	10.20120	ns

Notes:

1. Ideal DC Target: This serves only as an ideal reference target (0 ppm) to use for calculating the rest of the period measurement values
2. 0.1-second Measurement Window (frequency counter): Valuable measurement done using a frequency counter to determine near DC average frequency (filtering out all jitter including SSC and cycle to cycle). This is used to determine if the system has a frequency static offset caused usually by incorrect crystal, crystal loading or incorrect clock configuration.
3. 1.0- μ s Measurement Window (scope): This measurement is only used in conjunction with clock post processing software (Jit3 Advanced for example) with "filters = LPF 3RD order 1-MHz pole" to filter out high frequency jitter (FM) and show the underlying SSC profile. The numbers here bound the SSC min/ max excursions (SSC magnitude).
4. 1CLK - No Filter: Any 1 Period measured with a scope. Measured on a real time Oscilloscope using no filters, a simple period measurement (or a Jit3 period measurement - more accurate), provides absolute Min/Max timing information.

Table 9-15. Differential Clocks (SSC off)

SSC OFF	1CLK	0.1s		0.1s	1CLK	
Signal Name	-Jitter c-c AbsPerMin	-ppm LongAvgMin	Ideal DC target	+ppm LongAvgMax	+Jitter c-c AbsPerMax	Units
BCLK	9.849000	9.999000	10.00000	10.00100	10.15100	ns

Notes:

1. Ideal DC Target: This serves only as an ideal reference target (0ppm) to use for calculating the rest of the period measurement values
2. 0.1-second Measurement Window (frequency counter): Valuable measurement done using a frequency counter to determine near DC average frequency (filtering out all jitter including SSC and cycle to cycle). This is used to determine if the system has a frequency static offset caused usually by incorrect crystal, crystal loading or incorrect clock configuration.
3. 1CLK - No Filter: Any 1 Period measured with a scope. Measured on a real time Oscilloscope using no filters, a simple period measurement (or a Jit3 period measurement - more accurate), provides absolute Min / Max timing information.

Table 9-16. Processor Clock Jitter Specifications (cycle-cycle)

Symbol	Frequency (MHz)	Type	Source (ps)	Destination	Notes
BCLK _{JIT_CC}	100	Input Diff	150	processor/memory/PCI Express*	1

Notes:

1. On all jitter measurements care should be taken to set the zero crossing voltage (for rising edge) of the clock to be the point where the edge rate is the fastest. Using a Math function = Average (Derivative (Ch1)) and set the averages to 64, place the cursors where the slope is the highest on the rising edge - usually the lower half of the rising edge. This is defined because Flip Chip components prevent probing at the end of the transmission line. This will result in a reflection induced ledge in the middle of the rising edge and will significantly increase measured jitter.

Table 9-17. System Reference Clock DC and AC Specifications

Symbol	Parameter	Signal	Min	Max	Unit	Meas	Figure	Notes
Slew _{rise}	Rising Slew Rate	Diff	1.5	4.0	V/ns	Avg	9-3	2,3
Slew _{fall}	Falling Slew Rate	Diff	1.5	4.0	V/ns	Avg	9-3	2,3
Slew _{var}	Slew Rate Matching	Single Ended		20	%	Avg	9-4	1,9
V _{SWING}	Differential Output Swing	Diff	300		mV	RT	9-3	2



Table 9-17. System Reference Clock DC and AC Specifications

Parameter	Description	Configuration	250	550	Unit	Test Condition	Reference	Notes
V_{CROSS}	Crossing Point Voltage	Single Ended	250	550	mV	RT	9-4	1,4,5
V_{CROSS_DELTA}	Variation of V_{CROSS}	Single Ended		140	mV	RT	9-4	1,4,8
V_{MAX}	Max Output Voltage	Single Ended		1.15	V	RT	9-4	1,6
V_{MIN}	Min Output Voltage	Single Ended	-0.3		V	RT	9-4	1,7
DTY_CYC	Duty Cycle	Diff	40	60	%	Avg	9-3	2

Notes:

- Measurement taken from single-ended waveform on a component test board.
- Measurement taken from differential waveform on a component test board.
- Slew rate measured through V_{SWING} voltage range centered about differential zero.
- V_{CROSS} is defined as the voltage where Clock = Clock#.
- Only applies to the differential rising edge (i.e., Clock rising and Clock# falling).
- The max voltage including overshoot.
- The min voltage including undershoot.
- The total variation of all V_{CROSS} measurements in any particular system. This is a subset of $V_{CROSS_MIN/MAX}$ (V_{CROSS} absolute) allowed. The intent is to limit V_{CROSS} induced modulation by setting V_{CROSS_DELTA} to be smaller than V_{CROSS} absolute.
- Matching applies to rising edge rate for Clock and falling edge rate for Clock#. It is measured using a ± 75 mV window centered on the average cross point where Clock rising meets Clock# falling (See Figure 17, "Differential Clock – Differential Measurements" on page 121). The median cross point is used to calculate the voltage thresholds the oscilloscope is to use for the edge rate calculations.

9.11.1 DDR3 AC Specifications

The following notes apply to Table 9-18, Table 9-19 and Table 9-20.

Note	Definition
1	Unless otherwise noted, all specifications in this table apply to all processor frequencies. Timing specifications only depend on the operating frequency of the memory channel and not the maximum rated frequency.
2	When the single ended slew rate of the input Data or Strobe signals, within a byte group, are below 1.0 V/ns, the T_{SU} and T_{HD} specifications must be increased by a de-rating factor. The input single ended slew rate is measured DC to AC levels; V_{IL_DC} to V_{IH_AC} for rising edges, and V_{IH_DC} to V_{IL_AC} for falling edges. Use the worse case minimum slew rate measured between Data and Strobe, within a byte group, to determine the required de-rating value. No de-rating is required for single ended slew rates equal to or greater than 1.0 V/ns.
3	Edge Placement Accuracy (EPA): The silicon contains digital logic that automatically adjusts the timing relationship between the DDR reference clocks and DDR signals. The BIOS initiates a training procedure that will place a given signal appropriately within the clock period. The difference in delay between the signal and clock is accurate to within \pm EPA. This EPA includes jitter, skew, within die variation and several other effects.
4	Data to Strobe read setup and Data from Strobe read hold minimum requirements specified at the processor pad are determined with the minimum Read DQS/DQS# delay.
5	C_{WL} (CAS Write Latency) is the delay, in clock cycles, between the rising edge of CK where a write command is referenced and the first rising strobe edge where the first byte of write data is present. The C_{WL} value is determined by the value of the CL (CAS Latency) setting.
6	The system memory clock outputs are differential (CLK and CLK#), the CLK rising edge is referenced at the crossing point where CLK is rising and CLK# is falling.
7	The system memory strobe outputs are differential (DQS and DQS#), the DQS rising edge is referenced at the crossing point where DQS is rising and DQS# is falling, and the DQS falling edge is referenced at the crossing point where DQS is falling and DQS# is rising.
8	This value specifies the parameter after write levelling, representing the residual error in the controller after training, and does not include any effects from the DRAM itself.



**Table 9-18. DDR3 Electrical Characteristics and AC Timings at 1066 MT/s,
V_{DDQ} = 1.5 V ±0.075 V**

Symbol	Parameter	Channel A Channel B		Unit	Figure	Note ^{1,9}
		Max	Min			
System Memory Latency Timings						
$T_{CL} - T_{RCD} - T_{RP}$	CAS Latency – RAS to CAS Delay – Pre-charge Command Period	7 – 7 – 7 8 – 8 – 8		T_{CK}		
Electrical Characteristics						
T_{SLR_D}	DQ[63:0], DQS[8:0], DQS#[8:0] Input Slew Rate	6.5	2.0	V/ns		2
System Memory Clock Timings						
T_{CK}	CK Period	1.875		ns		
T_{CH}	CK High Time		0.8125	ns		
T_{CL}	CK Low Time		0.8125	ns		
T_{SKEW}	Skew Between Any System Memory Differential Clock Pair (CK/CKB)	100		ps		
System Memory Command Signal Timings						
T_{CMD_CO}	RAS#, CAS#, WE#, MA[14:0], BA[2:0] Edge Placement Accuracy	+145	-145	ps	9-5	3,4,6
System Memory Control Signal Timings						
T_{CTRL_CO}	CS#[1:0], CKE[1:0], ODT[1:0] Edge Placement Accuracy	+145	-145	ps	9-5	3,6
System Memory Data and Strobe Signal Timings						
$T_{DVB} + T_{DVA}$	DQ[63:0] Valid before DQS[8:0] Rising or Falling Edge		687.5	ps		7
T_{Su+HD}	DQ Input Setup plus Hold Time to DQS Rising or Falling Edge		200	ps	9-6	1,2,7
T_{DQS_CO}	DQS Edge Placement Accuracy to CK Rising Edge AFTER write levelling	+250	-250	ns	9-7	8
T_{WPRE}	DQS/DQS# Write Preamble Duration		1.0	T_{CK}		
T_{WPST}	DQS/DQS# Write Postamble Duration		0.5	T_{CK}		
T_{DQSS}	CK Rising Edge Output Access Time, Where a Write Command Is Referenced, to the First DQS Rising Edge	$C_{WL} \times (T_{CK} + 4)$		ns		5,6



Table 9-19. DDR3 Electrical Characteristics and AC Timings at 1333 MT/s, $V_{DDQ} = 1.5\text{ V} \pm 0.075\text{ V}$

Symbol	Parameter	Channel A Channel B		Unit	Figure	Note ^{1,9}
		Max	Min			
System Memory Latency Timings						
$T_{CL} - T_{RCD} - T_{RP}$	CAS Latency – RAS to CAS Delay – Pre-charge Command Period	9 – 9 – 9		T_{CK}		
Electrical Characteristics						
T_{SLR_D}	DQ[63:0], DQS[8:0], DQS#[8:0] Input Slew Rate	6.5	2.0	V/ns		2
System Memory Clock Timings						
T_{CK}	CK Period	1.50		ns		
T_{CH}	CK High Time		0.625	ns		
T_{CL}	CK Low Time		0.625	ns		
T_{SKEW}	Skew Between Any System Memory Differential Clock Pair (CK/CKB)	100		ps		
System Memory Command Signal Timings						
T_{CMD_CO}	RAS#, CAS#, WE#, MA[14:0], BA[2:0] Edge Placement Accuracy	+145	-145	ps	9-5	3,4,6
System Memory Control Signal Timings						
T_{CTRL_CO}	CS#[1:0], CKE[1:0], ODT[1:0] Edge Placement Accuracy	+145	-145	ps	9-5	3,6
System Memory Data and Strobe Signal Timings						
$T_{DVB} + T_{DVA}$	DQ[63:0] Valid before DQS[8:0] Rising or Falling Edge		500	ps		7
T_{Su+HD}	DQ Input Setup Plus Hold Time to DQS Rising or Falling Edge		200	ps	9-6	1,2,7
T_{DOS_CO}	DQS Edge Placement Accuracy to CK Rising Edge AFTER Write Levelling	+250	-250	ps	9-7	8
T_{WPRE}	DQS/DQS# Write Preamble Duration		1.0	T_{CK}		
T_{WPST}	DQS/DQS# Write Postamble Duration		0.5	T_{CK}		
T_{DOSS}	CK Rising Edge Output Access Time, Where a Write Command Is Referenced, to the First DQS Rising Edge	$C_{WL} \times (T_{CK} + 4)$		ns		5,6



**Table 9-20. DDR3 Electrical Characteristics and AC Timings at 1600 MT/s,
V_{DDQ} = 1.5 V ±0.075 V**

Symbol	Parameter	Channel A Channel B		Unit	Figure	Note ^{1,9}
		Max	Min			
System Memory Latency Timings						
$T_{CL} - T_{RCD} - T_{RP}$	CAS Latency – RAS to CAS Delay – Pre-charge Command Period	11 – 11– 11		T_{CK}		
Electrical Characteristics						
T_{SLR_D}	DQ[63:0], DQS[8:0], DQS#[8:0] Input Slew Rate	6.5	2.0	V/ns		2
System Memory Clock Timings						
T_{CK}	CK Period	1.25		ns		
T_{CH}	CK High Time		0.5	ns		
T_{CL}	CK Low Time		0.5	ns		
T_{SKEW}	Skew Between Any System Memory Differential Clock Pair (CK/CKB)	100		ps		
System Memory Command Signal Timings						
T_{CMD_CO}	RAS#, CAS#, WE#, MA[14:0], BA[2:0] Edge Placement Accuracy	+145	-145	ps	9-5	3,4,6
System Memory Control Signal Timings						
T_{CTRL_CO}	CS#[1:0], CKE[1:0], ODT[1:0] Edge Placement Accuracy	+145	-145	ps	9-5	3,6
System Memory Data and Strobe Signal Timings						
$T_{DVB}+T_{DVA}$	DQ[63:0] Valid before DQS[8:0] Rising or Falling Edge		375	ps		7
T_{Su+HD}	DQ Input Setup Plus Hold Time to DQS Rising or Falling Edge		200	ps	9-6	1,2,7
T_{DQS_CO}	DQS Edge Placement Accuracy to CK Rising Edge AFTER Write Levelling	+125	-125	ps	9-7	8
T_{WPRE}	DQS/DQS# Write Preamble Duration		1.0	T_{CK}		
T_{WPST}	DQS/DQS# Write Postamble Duration		0.5	T_{CK}		
T_{DQSS}	CK Rising Edge Output Access Time, Where a Write Command Is Referenced, to the First DQS Rising Edge	$C_{WL} \times (T_{CK} + 4)$		ns		5,6



9.11.2 PCI Express* AC Specification

Table 9-21. PCI Express* AC Specification

Symbol	Parameter	Min	Max	Units	Figure	Notes ¹
UI	Unit Interval (Gen 1)	399.88	400.12	ps		3,4 for Tx, 5 for Rx
	Unit Interval (Gen 2)	199.94	200.06	ps		
T _{TX-EYE}	Minimum Transmission Eye Width	0.75		UI		6,7,8,9,10
T _{TX-RISE/FALL}	D+ /D- TX Out put Rise/Fall time (Gen 1)	0.125		UI		7,11
	D+ /D- TX Out put Rise/Fall time (Gen 2)	0.15		UI		
T _{RX-EYE}	Minimum Receiver Eye Width (Gen 1)	0.4		UI	9-8	12,14
T _{RX-TJ-CC}	Max Rx Inherent Timing Error (Gen 2)		0.40	UI		2,13

Notes:

1. See the *PCI Express Base Specification* for details.
2. Max Rx inherent total timing error for common Refclk Rx architecture.
3. The specified UI is equivalent to a tolerance of ±300 ppm for each Refclk source. Period does not account for SSC induced variations.
4. SSC permits a +0, - 5000 ppm modulation of the clock frequency at a modulation rate not to exceed 33 kHz.
5. UI does not account for SSC caused variations.
6. Does not include SSC or Refclk jitter. Includes Rj at 10⁻¹². 2.5 GT/s and 5.0 GT/s use different jitter determination methods.
7. Measurements at 5.0 GT/s require an oscilloscope with a bandwidth of ≥ 12.5 GHz, or equivalent, while measurements made at 2.5 GT/s require a scope with at least 6.2 GHz bandwidth. Measurement at 5.0 GT/s must deconvolve effects of compliance test board to yield an effective measurement at TX pins. 2.5 GT/s may be measured within 200 mils of Tx device's pins, although deconvolution is recommended. For measurement setup details, see the *PCI Express Base Specification*. At least 10⁶ UI of data must be acquired.
8. Transmitter jitter is measured by driving the Transmitter under test with a low jitter "ideal" clock and connecting the DUT to a reference load.
9. Transmitter raw jitter data must be convolved with a filtering function that represents the worst case CDR tracking BW. 2.5 GT/s and 5.0 GT/s use different filter functions that are defined in the *PCI Express Base Specification*. After the convolution process has been applied, the center of the resulting eye must be determined and used as a reference point for obtaining eye voltage and margins.
10. For 5.0 GT/s, de-emphasis timing jitter must be removed. An additional HPF function must be applied as shown in the *PCI Express Base Specification*. This parameter is measured by accumulating a record length of 10⁶ UI while the DUT outputs a compliance pattern. TMIN-PULSE is defined to be nominally 1 UI wide and is bordered on both sides by pulses of the opposite polarity. See the *PCI Express Base Specification* for more details.
11. Measured differentially from 20% to 80% of swing.
12. Receiver eye margins are defined into a 2 x 50 Ω reference load. A Receiver is characterized by driving it with a signal whose characteristics are defined by the parameters specified in the *PCI Express Base Specification*.
13. The four inherent timing error parameters are defined for the convenience of Rx designers, and they are measured during Receiver tolerancing.
14. Minimum eye time at Rx pins to yield a 10⁻¹² BER.



9.11.3 Miscellaneous AC Specifications

Table 9-22. Miscellaneous AC Specifications

T# Parameter	Min	Max	Unit	Figure	Notes
T1: Asynchronous GTL input pulse width	8	-	BCLKs	9-10	1,2,3
T4: PROCHOT# pulse width	500	-	μs	9-10	1,2,3
T5: THERMTRIP# assertion until V _{CC} removed	-	500	ms	9-11	1,2,3

Notes:

1. Unless otherwise noted, all specifications in this table apply to all processor frequencies.
2. All AC timing for the Asynchronous GTL signals are referenced to the BCLK rising edge at Crossing Voltage (V_{CROSS}). SM_DRAMPWROK are referenced to the BCLK rising edge at 0.5 * V_{TT}.
3. These signals may be driven asynchronously.

9.11.4 TAP Signal Group AC Specifications

Table 9-23. TAP Signal Group AC Specifications

T# Parameter	Min	Max	Unit	Figure	Notes
T14: TCK Period	15		ns		1,2,3,4
T15: TDI, TMS Setup Time	6.5		ns	9-9	1,2,3,4
T16: TDI, TMS Hold Time	6.5		ns	9-9	1,2,3,4
T17: TDO Clock to Output Delay	0	5	ns	9-9	1,2,3,4
T18: TRST# Assert Time	2		T _{TCK}	9-9	1,2,3,4,5

Notes:

1. Unless otherwise noted, all specifications in this table apply to all processor frequencies.
2. Not 100% tested. Specified by design characterization.
3. It is recommended that TMS be asserted while TRST# is being deasserted.
4. Referenced to the rising edge of TCK.
5. TRST# is synchronized to TCK and asserted for 5 TCK periods while TMS is asserted.



9.11.5 SVID Signal Group AC Specifications

Table 9-24. SVID Signal Group AC Specifications

T # Parameter	Min	Max	Unit	Notes ^{1, 2}
VIDSCLK period	38.90	-	ns	
VIDSOUT output valid delay wrt to BCLK	1.20	9.60	ns	
VIDSOUT output jitter	-3.60	0.65	ns	3
VIDSOUT input setup time	1.00	-	ns	3,4
VIDSOUT input hold time	3.00	-	ns	3,4
VIDSCLK High Time	12.00	-	ns	5
VIDSCLK Low Time	12.00	-	ns	6
VIDSCLK Rise Time	-	2.50	ns	7
VIDSCLK Fall Time	-	2.50	ns	8
Duty Cycle	45.00	55.00	%	

Notes:

1. See the voltage regulator design guidelines for additional information.
2. Platform support for SVID transitions is required for the processor to operate within specifications.
3. Referenced to rising edge of VIDSCLK.
4. Minimum edge rate of 0.5V/nS.
5. High time is measured with respect to 0.3 * VCCIO.
6. Low time is measured with respect to 0.7 * VCCIO.
7. Rise time is measured from 0.3 * VCCIO to 0.7 * VCCIO.
8. Fall time is measured 0.7 * VCCIO to 0.3 * VCCIO.
9. Period and duty cycle are measured with respect to 0.5 * VCCIO.

9.12 Processor AC Timing Waveforms

Figure 9-3 through Figure 9-11 are used in conjunction with the AC timing tables, Table 9-14 through Table 9-24.

Note: For Table 9-3 through Table 9-13, the following notes apply:

1. All common clock AC timings signals are referenced to the Crossing Voltage (V_{CROSS}) of the BCLK, BCLK# at rising edge of BCLK.
2. All source synchronous AC timings are referenced to their associated strobe (address or data). Source synchronous data signals are referenced to the falling edge of their associated data strobe. Source synchronous address signals are referenced to the rising and falling edge of their associated address strobe.
3. All AC timings for the TAP signals are referenced to the TCK at 0.5 * V_{CCIO} at the processor balls. All TAP signal timings (TMS, TDI, etc.) are referenced at 0.5 * V_{CCIO} at the processor die (pads).
4. All CMOS signal timings are referenced at 0.5 * V_{CCIO} at the processor pins.

Figure 9-3. Differential Clock – Differential Measurements

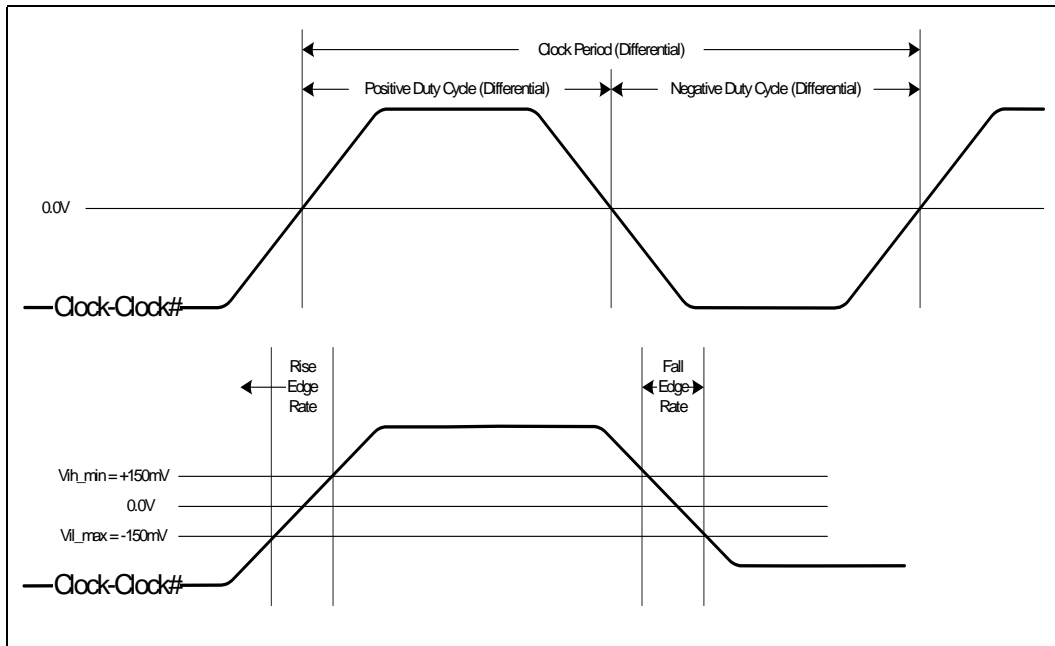



Figure 9-4. Differential Clock – Single Ended Measurements

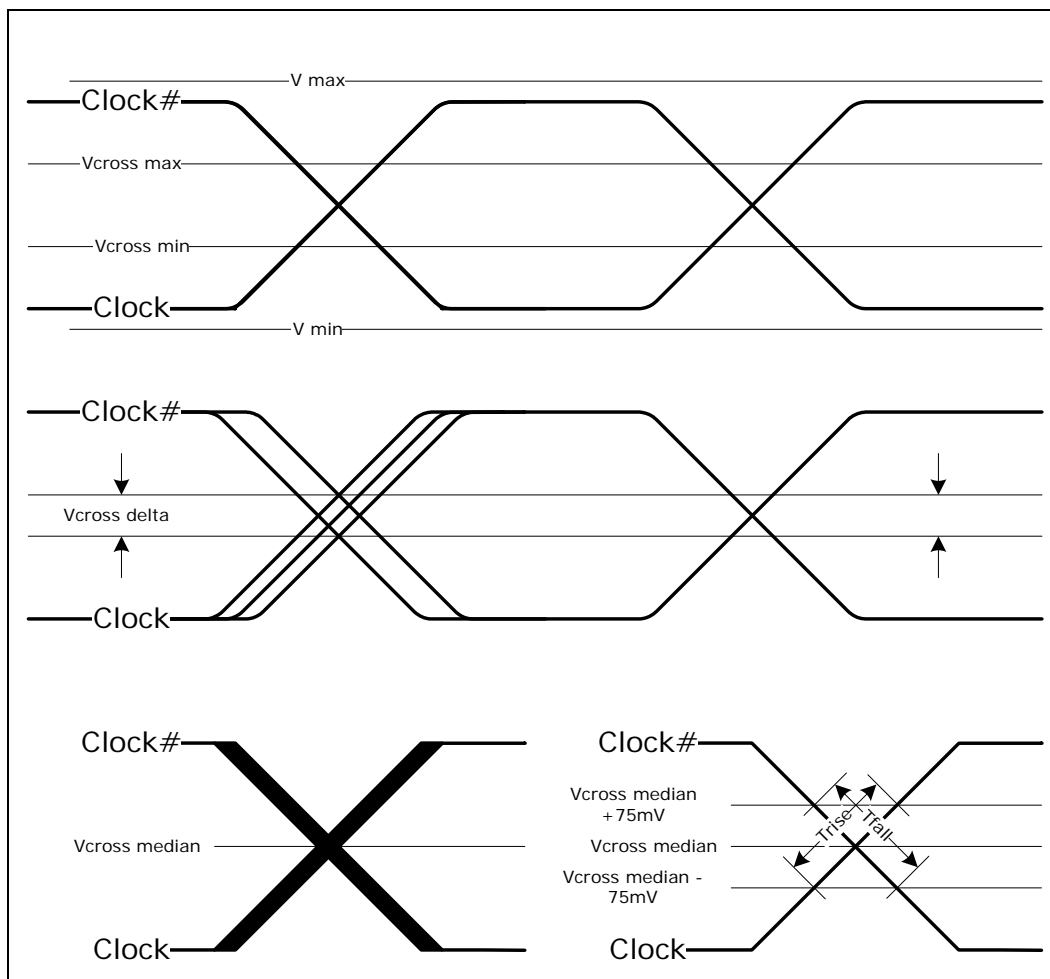

Figure 9-5. DDR3 Command / Control and Clock Timing Waveform

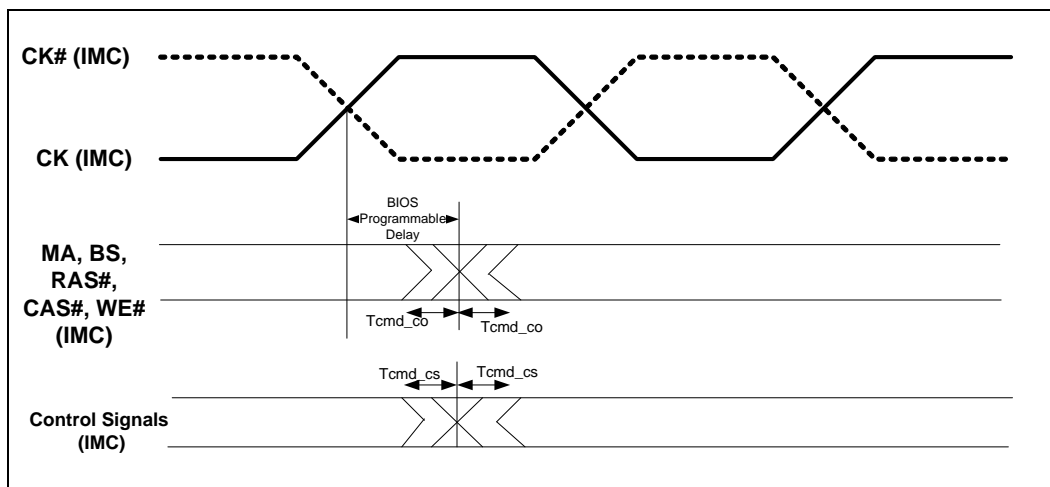

Figure 9-6. DDR3 Receiver Eye Mask

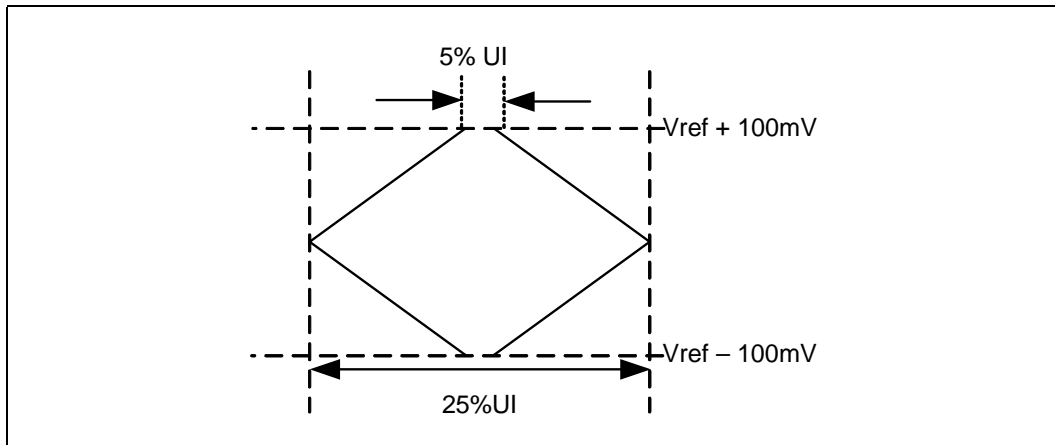

Figure 9-7. DDR3 Clock to DQS Skew Timing Waveform

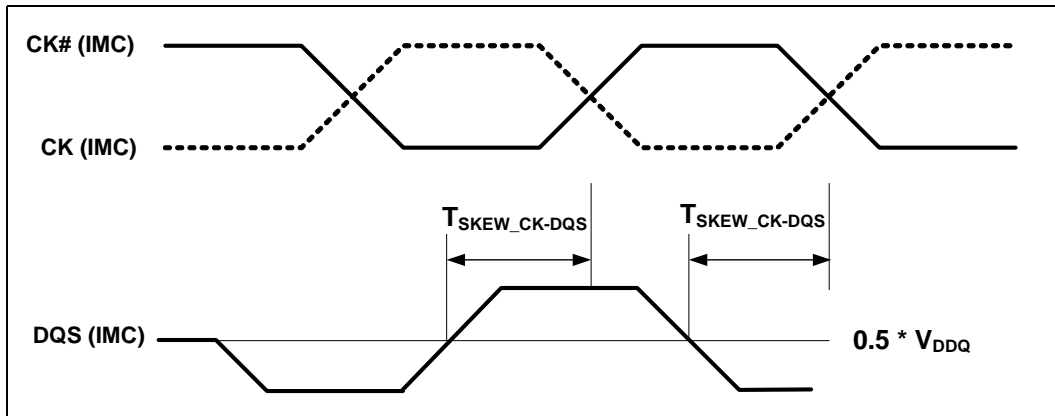



Figure 9-8. PCI Express* Receiver Eye Margins

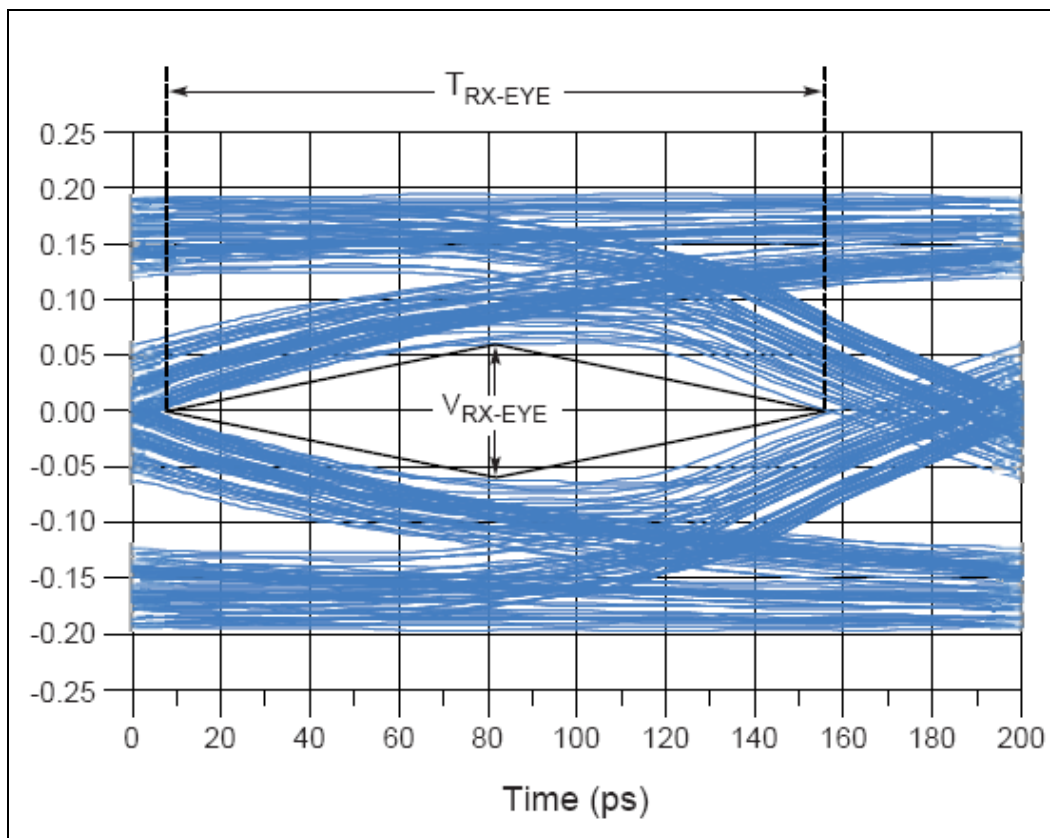
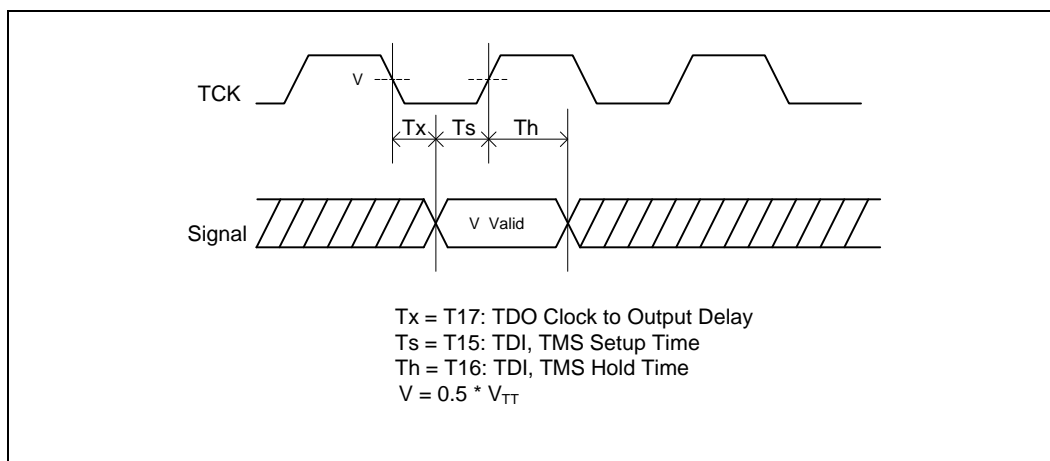

Figure 9-9. TAP Valid Delay Timing Waveform



Note: See Table 9-11 for TAP Signal Group DC specifications and Table 9-23 for TAP Signal Group AC specifications.

Figure 9-10. Test Reset (TRST#), Async Input, and PROCHOT# Timing Waveform

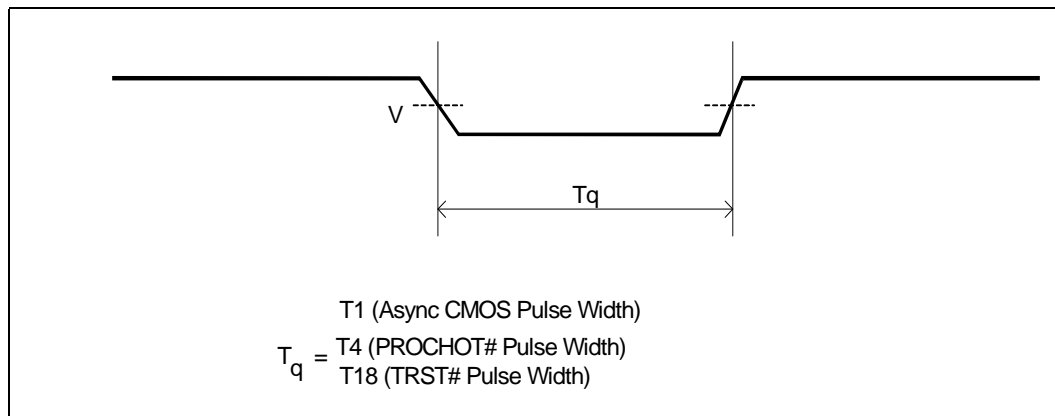
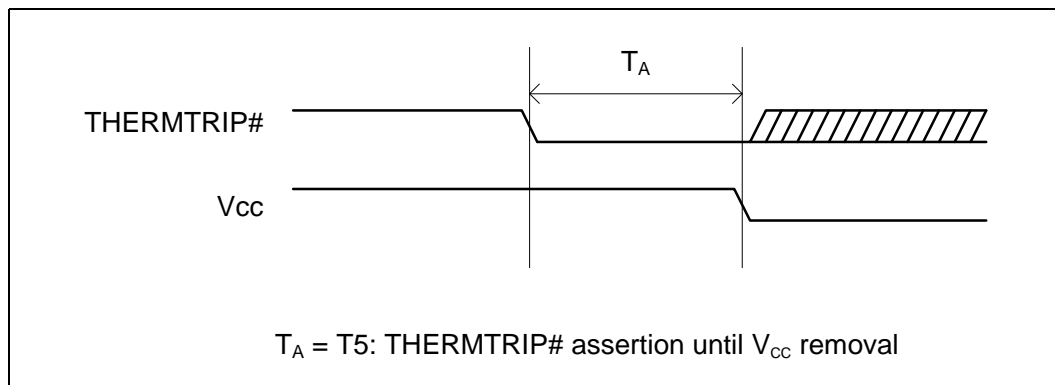

Figure 9-11. THERMTRIP# Power Down Sequence



9.13 Signal Quality

Data transfer requires the clean reception of data signals and clock signals. Ringing below receiver thresholds, non-monotonic signal edges, and excessive voltage swings will adversely affect system timings. Ringback and signal non-monotonically cannot be tolerated since these phenomena may inadvertently advance receiver state machines. Excessive signal swings (overshoot and undershoot) are detrimental to silicon gate oxide integrity, and can cause device failure if absolute voltage limits are exceeded. Overshoot and undershoot can also cause timing degradation due to the build up of inter-symbol interference (ISI) effects.

For these reasons, it is crucial that the designer work towards a solution that provides acceptable signal quality across all systematic variations encountered in volume manufacturing.

This section documents signal quality metrics used to derive topology and routing guidelines through simulation. All specifications are specified at the processor die (pad measurements).

Specifications for signal quality are for measurements at the processor core only and are only observable through simulation. Therefore, proper simulation is the only way to verify proper timing and signal quality.



9.13.1 Input Reference Clock Signal Quality Specifications

Overshoot/Undershoot and Ringback specifications for BCLK/BCLK# are found in [Table 9-26](#). Overshoot/Undershoot and Ringback specifications for the DDR3 Reference Clocks are specified by the DIMM.

9.13.2 DDR3 Signal Quality Specifications

Signal Quality specifications for Differential DDR3 Signals are included as part of the DDR3 DC specifications and DDR3 AC specifications. Various scenarios have been simulated to generate a set of layout guidelines which are available in the appropriate platform design guide.

9.13.3 I/O Signal Quality Specifications

Signal Quality specifications for PCIe* Signals are included as part of the PCIe* DC specifications and PCIe* AC specifications. Various scenarios have been simulated to generate a set of layout guidelines which are available in the appropriate platform design guide.

9.14 Overshoot/Undershoot Guidelines

Overshoot (or undershoot) is the absolute value of the maximum voltage above or below V_{SS} . The overshoot/undershoot specifications limit transitions beyond V_{CCIO} or V_{SS} due to the fast signal edge rates. The processor can be damaged by single and/or repeated overshoot or undershoot events on any input, output, or I/O buffer if the charge is large enough (i.e., if the over/undershoot is great enough). Baseboard designs which meet signal integrity and timing requirements and which do not exceed the maximum overshoot or undershoot limits listed in [Table 9-26](#) will insure reliable IO performance for the lifetime of the processor.

9.14.1 V_{CC} Overshoot Specification

When transitioning from a high-to-low current load condition, the processor can tolerate short transient overshoot events where V_{CC} exceeds the HFM_VID voltage. This overshoot cannot exceed $VID + V_{OS_MAX}$. V_{OS_MAX} is the maximum allowable overshoot above VID. These specifications apply to the processor die voltage as measured across the V_{CC_SENSE} and V_{SS_SENSE} lands.

Table 9-25. V_{CC} Overshoot Specifications

Symbol	Parameter	Min	Max	Units	Figure	Notes
V_{OS_MAX}	Magnitude of V_{CC} overshoot above VID	-	50	mV	9-12	1
$T_{VCC_OS_MAX}$	Time duration of V_{CC} overshoot above VID	-	10	μ s	9-12	1

Notes:

1. For overshoot, SVID is inclusive of the tolerance band (TOL_{VCC}) and ripple.

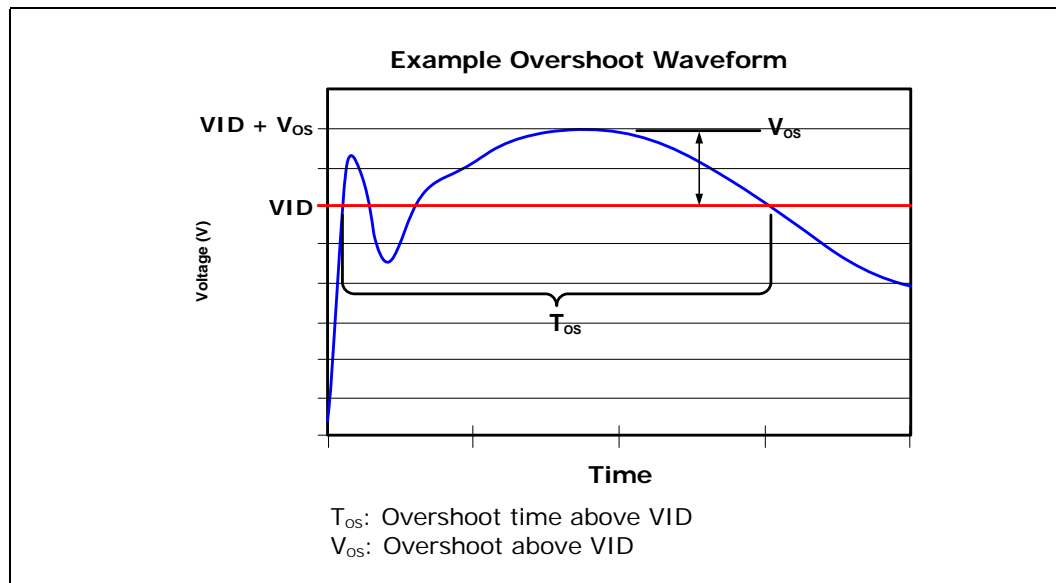
Figure 9-12. V_{CC} Overshoot Example Waveform

Note: Oscillations below the reference voltage cannot be subtracted from the total overshoot/undershoot pulse duration.

9.14.2 Overshoot/Undershoot Magnitude

Magnitude describes the maximum potential difference between a signal and its voltage reference level. For the processor, both are referenced to V_{SS} . Important: The overshoot and undershoot conditions are separate and their impact must be determined independently.

The pulse magnitude and duration must be used to determine if the overshoot/undershoot pulse is within specifications.

9.14.3 Overshoot/Undershoot Pulse Duration

Pulse duration describes the total amount of time that an overshoot/undershoot event exceeds the overshoot/undershoot reference voltage. The total time could encompass several oscillations above the reference voltage. Multiple overshoot/undershoot pulses within a single overshoot/undershoot event may need to be measured to determine the total pulse duration.

Note: Oscillations below the reference voltage cannot be subtracted from the total overshoot/undershoot pulse duration.

Table 9-26. Processor Overshoot/Undershoot Specifications

Signal Group	Maximum Overshoot	Overshoot Duration	Minimum Undershoot	Undershoot Duration	Notes
DDR3	$1.2 \cdot V_{DDQ}$	$0.25 \cdot T_{CH}$	$-0.15 \cdot V_{DDQ}$	$0.25 \cdot T_{CH}$	1, 2



Table 9-26. Processor Overshoot/Undershoot Specifications

Signal Group	Maximum Overshoot	Overshoot Duration	Minimum Undershoot	Undershoot Duration	Notes
Control Sideband and TAP Signals groups	$1.18 \cdot V_{CCIO}$	37ns	$-0.27 \cdot V_{CCIO}$	3ns	1,2
PCIe and DMI	$1.2 \cdot V_{CCIO}$	0.25UI	$-0.275 \cdot V_{CCIO}$	0.25UI	1,2

Notes:

1. These specifications are measured at the processor pin.
2. See Figure 9-13 for description of allowable Overshoot/Undershoot magnitude and duration.

Figure 9-13. Maximum Acceptable Overshoot/Undershoot Waveform

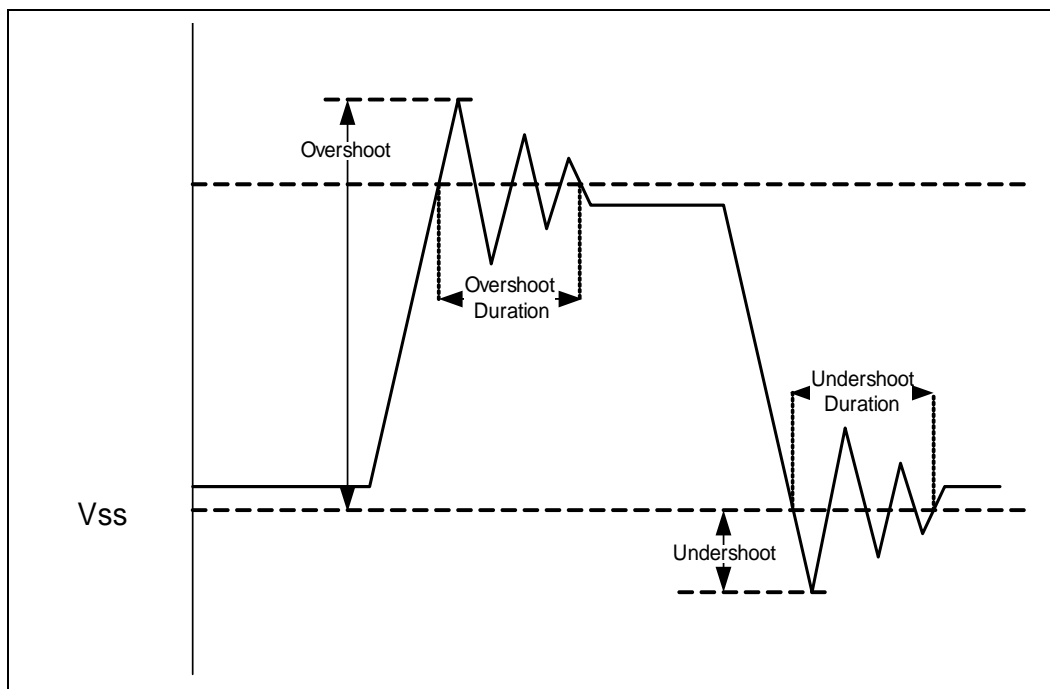

§ §





10.0 Processor Ball and Package Information

10.1 Processor Ball Assignments

- [Table 10-1](#) provides a listing of all processor pins ordered alphabetically by ball name.
- [Table 10-2](#) provides a listing of all processor pins ordered alphabetically by ball number.
- [Figure 10-1](#), [Figure 10-2](#), [Figure 10-3](#), and [Figure 10-4](#) show the bottom view of the processor ballmap.



Table 10-1. Alphabetical Ball Listing

Ball	Signal	Ball	Signal	Ball	Signal
A3	VSS	B9	VSS	C13	VSS
A4	VSS	B10	PCIE2_RX#[2]	C14	VCC
A5	PCIE1_RX[6]	B11	PCIE2_RX[2]	C15	VCC
A6	PCIE1_RX#[6]	B12	VSS	C16	VSS
A7	VSS	B13	VSS	C17	VCC
A8	PCIE1_RX#[1]	B14	VCC	C18	VCC
A9	PCIE1_RX[1]	B15	VCC	C19	VSS
A10	VSS	B16	VSS	C20	VCC
A11	PCIE2_RX#[3]	B17	VCC	C21	VCC
A12	PCIE2_RX[3]	B18	VCC	C22	VSS
A13	VSS	B19	VSS	C23	VCC
A14	VCC	B20	VCC	C24	VCC
A15	VCC	B21	VCC	C25	VSS
A16	VSS	B22	VSS	C26	BPM#[2]
A17	VCC	B23	VCC	C27	BPM#[1]
A18	VCC	B24	VCC	C28	RSVD_42
A19	VSS	B25	VSS	C29	VSS
A20	VCC	B26	BPM#[5]	C30	VSS
A21	VCC	B27	RSVD_22	C31	RSVD_29
A22	VSS	B28	VSS	C32	RSVD_27
A23	VCC	B29	VSS	C33	RSVD_21
A24	VCC	B30	RSVD_12	C34	VSS
A25	VSS	B31	VSS	C35	RSVD_26
A26	BPM#[4]	B32	RSVD_53	C36	RSVD_23
A27	VSS	B33	VSS	D1	VSS
A28	RSVD_14	B34	RSVD_28	D2	PCIE1_RX#[11]
A29	RSVD_31	B35	RSVD_52	D3	PCIE1_RX[11]
A30	RSVD_13	C1	VSS	D4	VSS
A31	RSVD_30	C2	VSS	D5	PCIE1_RX[7]
A32	VSS	C3	PCIE1_RX#[10]	D6	PCIE1_RX#[7]
A33	RSVD_33	C4	PCIE1_RX[10]	D7	VSS
A34	RSVD_54	C5	VSS	D8	PCIE1_RX#[2]
B2	VSS	C6	PCIE1_RX[5]	D9	PCIE1_RX[2]
B3	VSS	C7	PCIE1_RX#[5]	D10	PCIE2_RX#[0]
B4	PCIE1_RX[9]	C8	VSS	D11	PCIE2_RX#[1]
B5	PCIE1_RX#[9]	C9	PCIE1_RX[0]	D12	PCIE2_RX[1]
B6	VSS	C10	PCIE1_RX#[0]	D13	VSS
B7	PCIE1_RX[4]	C11	VSS	D14	VCC
B8	PCIE1_RX#[4]	C12	PCIE_RCOMPO	D15	VCC



Ball	Signal
D16	VSS
D17	VCC
D18	VCC
D19	VSS
D20	VCC
D21	VCC
D22	VSS
D23	VCC
D24	VCC
D25	VSS
D26	BPM#[3]
D27	VSS
D28	BPM#[0]
D29	RSVD_44
D30	TCK
D31	VSS
D32	VSS
D33	RSVD_39
D34	RSVD_20
D35	VSS
D36	RSVD_40
E1	PCIE1_RX#[12]
E2	PCIE1_RX[12]
E3	VSS
E4	PCIE1_RX[8]
E5	PCIE1_RX#[8]
E6	VSS
E7	PCIE1_RX[3]
E8	PCIE1_RX#[3]
E9	VSS
E10	VSS
E11	PCIE2_RX[0]
E12	VSS
E13	VSS
E14	VCC
E15	VCC
E16	VSS
E17	VCC
E18	VCC
E19	VSS
E20	VCC

Ball	Signal
E21	VCC
E22	VSS
E23	VCC
E24	VCC
E25	VSS
E26	BPM#[6]
E27	RSVD_41
E28	PM_SYNC
E29	VIDSCLK
E30	TDI
E31	VIDALERT#
E32	RSVD_37
E33	VSS
E34	RSVD_38
E35	RSVD_18
E36	VSS
F1	PCIE_ICOMPO
F2	VSS
F3	PCIE1_RX#[13]
F4	PCIE1_RX[13]
F5	VSS
F6	VSS
F7	VSS
F8	VSS
F9	VSS
F10	VSS
F11	VSS
F12	VSS
F13	VSS
F14	VCC
F15	VCC
F16	VSS
F17	VCC
F18	VCC
F19	VSS
F20	VCC
F21	VCC
F22	VSS
F23	VCC
F24	VCC
F25	VSS

Ball	Signal
F26	BPM#[7]
F27	RSVD_43
F28	PROC_DETECT#
F29	VSS
F30	TMS
F31	VSS
F32	RSVD_19
F33	RSVD_16
F34	VSS
F35	RSVD_36
F36	RSVD_17
G1	PCIE1_RX[15]
G2	PCIE1_RX#[14]
G3	PCIE1_RX[14]
G4	VSS
G5	VSS
G6	PCIE1_TX[7]
G7	VSS
G8	PCIE1_TX#[4]
G9	PCIE1_TX[4]
G10	VSS
G11	PCIE1_TX#[0]
G12	PCIE1_TX[0]
G13	VSS
G14	VCC
G15	VCC
G16	VSS
G17	VCC
G18	VCC
G19	VSS
G20	VCC
G21	VCC
G22	VSS
G23	VCC
G24	VCC
G25	VSS
G26	VIDSOUT
G27	VSS
G28	VSS
G29	PREQ#
G30	RSVD_11



Ball	Signal
G31	THERMTRIP#
G32	VSS
G33	RSVD_34
G34	RSVD_32
G35	VSS
G36	RSVD_35
H1	PCIE1_RX#[15]
H2	VSS
H3	VSS
H4	VSS
H5	PCIE1_TX#[7]
H6	VSS
H7	PCIE1_TX#[5]
H8	PCIE1_TX[5]
H9	VSS
H10	PCIE1_TX[1]
H11	PCIE1_TX#[1]
H12	VSS
H13	VSS
H14	VCC
H15	VCC
H16	VSS
H17	VCC
H18	VCC
H19	VSS
H20	VCC
H21	VCC
H22	VSS
H23	VCC
H24	VCC
H25	VSS
H26	TRST#
H27	PROC_SELECT#
H28	CATERR#
H29	UNCOREPWRGOOD
H30	VSS
H31	RESET#
H32	PROCHOT#
H33	VSS
H34	RSVD_15
H35	RSVD_51

Ball	Signal
H36	VSS
J1	PCIE1_ICOMPI
J2	VSS
J3	PCIE1_TX[10]
J4	PCIE1_TX#[8]
J5	PCIE1_TX[8]
J6	PCIE1_TX#[6]
J7	PCIE1_TX[6]
J8	VSS
J9	PCIE1_TX#[2]
J10	PCIE1_TX[2]
J11	VSS
J12	RSVD_7
J13	VSS
J14	VCC
J15	VCC
J16	VSS
J17	VCC
J18	VCC
J19	VSS
J20	VCC
J21	VCC
J22	VSS
J23	VCC
J24	VCC
J25	VSS
J26	VCCSA_VID
J27	RSVD_48
J28	VSS
J29	RSVD_47
J30	RSVD_57
J31	RSVD_45
J32	VSS
J33	PECI
J34	VSS
J35	RSVD_25
J36	RSVD_50
K1	VSS
K2	PCIE1_TX[13]
K3	PCIE1_TX#[10]
K4	VSS

Ball	Signal
K5	PCIE1_TX#[9]
K6	PCIE1_TX[9]
K7	VSS
K8	PCIE1_TX#[3]
K9	PCIE1_TX[3]
K10	VSS
K11	PCIE2_TX#[3]
K12	PCIE2_TX[3]
K13	VSS
K14	VCC
K15	VCC
K16	VSS
K17	VCC
K18	VCC
K19	VSS
K20	VCC
K21	VCC
K22	VSS
K23	VCC
K24	VCC
K25	VSS
K26	PRDY#
K27	VSS
K28	RSVD_46
K29	VSS
K30	CFG[0]
K31	VSS
K32	CFG[7]
K33	VSS
K34	CFG[10]
K35	VSS
K36	RSVD_24
L1	PCIE1_TX#[14]
L2	PCIE1_TX#[13]
L3	VSS
L4	PCIE1_TX#[11]
L5	PCIE1_TX[11]
L6	VSS
L7	PCIE2_TX[1]
L8	PCIE2_TX#[1]
L9	VSS



Ball	Signal
L10	PCIE2_TX#[2]
L11	PCIE2_TX[2]
L12	RSVD_8
L13	VSS
L14	VCC
L15	VCC
L16	VSS
L17	VCC
L18	VCC
L19	VSS
L20	VCC
L21	VCC
L22	VSS
L23	VCC
L24	VCC
L25	VSS
L26	RSVD_55
L27	RSVD_56
L28	RSVD_49
L29	TDO
L30	CFG[1]
L31	CFG[4]
L32	CFG[5]
L33	CFG[16]
L34	CFG[9]
L35	CFG[13]
L36	VSS
M1	PCIE1_TX[14]
M2	VSS
M3	PCIE1_TX[15]
M4	VSS
M5	VSS
M6	PCIE2_TX[0]
M7	PCIE2_TX#[0]
M8	VSS
M9	VCCSA_VSSSENSE
M10	VCCSA_VCCSENSE
M11	VCCIO
M12	VCCIO
M13	VSS
M14	VCC

Ball	Signal
M15	VCC
M16	VSS
M17	VCC
M18	VCC
M19	VSS
M20	VCC
M21	VCC
M22	VSS
M23	VCC
M24	VCC
M25	VSS
M26	VCC_SENSE
M27	VSS_SENSE
M28	VSS
M29	VSS
M30	VSS
M31	VSS
M32	CFG[17]
M33	VSS
M34	CFG[11]
M35	VSS
M36	CFG[14]
N1	VSS
N2	RSVD_6
N3	PCIE1_TX#[15]
N4	PCIE1_TX#[12]
N5	PCIE1_TX[12]
N6	VSS
N7	VSS
N8	VCCIO
N9	VCCSA
N10	VCCIO
N11	VSS
N12	VCC
N13	VSS
N14	VCC
N15	VCC
N16	VSS
N17	VCC
N18	VCC
N19	VSS

Ball	Signal
N20	VCC
N21	VCC
N22	VSS
N23	VCC
N24	VCC
N25	VSS
N26	VCC
N27	VSS
N28	VCCIO
N29	VCCIO
N30	VSS
N31	CFG[3]
N32	CFG[6]
N33	CFG[8]
N34	CFG[2]
N35	CFG[12]
N36	CFG[15]
P1	DMI_TX[0]
P2	VSS
P3	VSS
P4	VSS
P5	VSS
P6	BCLK
P7	BCLK#
P8	VSS
P9	VCCSA
P10	VSS
P11	VCCSA
P12	VCC
P13	VSS
P14	VCC
P15	VCC
P16	VSS
P17	VCC
P18	VCC
P19	VSS
P20	VCC
P21	VCC
P22	VSS
P23	VCC
P24	VCC



Ball	Signal
P25	VSS
P26	VCC
P27	VSS
P28	VCCIO
P29	VCCIO
P30	VSS
P31	VSS
P32	VSS
P33	VSS
P34	VSS
P35	VSS
P36	VSS
R1	DMI_TX#[0]
R2	VSS
R3	DMI_RX[0]
R4	DMI_RX[1]
R5	VSS
R6	RSVD_9
R7	VCCIO
R8	VCCIO
R9	VCCSA
R10	VSS
R11	VCCSA
R12	VCC
R13	VSS
R14	VCC
R15	VCC
R16	VSS
R17	VCC
R18	VCC
R19	VSS
R20	VCC
R21	VCC
R22	VSS
R23	VCC
R24	VCC
R25	VSS
R26	VCC
R27	VCCIO
R28	VSS
R29	VCCIO

Ball	Signal
R30	VSS
R31	VSS
R32	SA_DQS[7]
R33	SA_DQ[59]
R34	SA_DQ[58]
R35	SA_DQ[62]
R36	SA_DQ[63]
T1	DMI_TX#[1]
T2	VSS
T3	DMI_RX#[0]
T4	DMI_RX#[1]
T5	VSS
T6	RSVD_10
T7	VCCIO
T8	VCCSA
T9	VSS
T10	VCCIO
T11	VCCSA
T12	VCC
T13	VSS
T14	VCC
T15	VCC
T16	VSS
T17	VCC
T18	VCC
T19	VSS
T20	VCC
T21	VCC
T22	VSS
T23	VCC
T24	VCC
T25	VSS
T26	VCC
T27	VCCIO
T28	VSS
T29	VCCIO
T30	VSS
T31	VSS
T32	SA_DQS#[7]
T33	SA_DQ[60]
T34	SA_DQ[61]

Ball	Signal
T35	SA_DQ[57]
T36	SA_DQ[56]
U1	DMI_TX[1]
U2	DMI_TX[2]
U3	VSS
U4	DMI_RX[2]
U5	VSS
U6	VSS
U7	VCCIO
U8	VCCIO
U9	VCCSA
U10	VSS
U11	VSS
U12	VCC
U13	VSS
U14	VCC
U15	VCC
U16	VSS
U17	VCC
U18	VCC
U19	VSS
U20	VCC
U21	VCC
U22	VSS
U23	VCC
U24	VCC
U25	VSS
U26	VCC
U27	VSS
U28	VCCIO
U29	VCCIO
U30	VSS
U31	VSS
U32	VSS
U33	VSS
U34	VSS
U35	VSS
U36	VSS
V1	DMI_TX#[3]
V2	DMI_TX#[2]
V3	VSS



Ball	Signal
V4	DMI_RX#[2]
V5	DMI_RX[3]
V6	VSS
V7	VCCIO
V8	VCCIO
V9	VCCSA
V10	VSS
V11	VCCSA
V12	VCC
V13	VSS
V14	VCC
V15	VCC
V16	VSS
V17	VCC
V18	VCC
V19	VSS
V20	VCC
V21	VCC
V22	VSS
V23	VCC
V24	VCC
V25	VSS
V26	VCC
V27	VSS
V28	VCCIO
V29	VCCIO
V30	VCCIO
V31	VSS
V32	SA_DQS[6]
V33	SA_DQ[51]
V34	SA_DQ[50]
V35	SA_DQ[54]
V36	SA_DQ[55]
W1	DMI_TX[3]
W2	VSS
W3	VSS
W4	VSS
W5	DMI_RX#[3]
W6	VSS
W7	VCCIO
W8	VCCSA

Ball	Signal
W9	VSS
W10	VCCIO
W11	VCCSA
W12	VCC
W13	VSS
W14	VCC
W15	VCC
W16	VSS
W17	VCC
W18	VCC
W19	VSS
W20	VCC
W21	VCC
W22	VSS
W23	VCC
W24	VCC
W25	VSS
W26	VCC
W27	VCCIO
W28	VSS
W29	VCCIO
W30	VCCIO
W31	VSS
W32	SA_DQS#[6]
W33	SA_DQ[52]
W34	SA_DQ[53]
W35	SA_DQ[49]
W36	SA_DQ[48]
Y1	VCCIO
Y2	VCCIO
Y3	VCCIO
Y4	VCCIO
Y5	VCCIO
Y6	VCCIO
Y7	VCCIO
Y8	VCCIO
Y9	VCCSA
Y10	VSS
Y11	VCCSA
Y12	VCC
Y13	VSS

Ball	Signal
Y14	VCC
Y15	VCC
Y16	VSS
Y17	VCC
Y18	VCC
Y19	VSS
Y20	VCC
Y21	VCC
Y22	VSS
Y23	VCC
Y24	VCC
Y25	VSS
Y26	VCC
Y27	VCCIO
Y28	VSS
Y29	VCCIO
Y30	VCCIO
Y31	VSS
Y32	VSS
Y33	VSS
Y34	VSS
Y35	VSS
Y36	VSS
AA1	VCCIO
AA2	VCCIO
AA3	VCCIO
AA4	VCCIO
AA5	VCCIO
AA6	VCCIO
AA7	VCCIO
AA8	VSS
AA9	VCCSA
AA10	VSS
AA11	VSS
AA12	VCC
AA13	VSS
AA14	VCC
AA15	VCC
AA16	VSS
AA17	VCC
AA18	VCC



Ball	Signal
AA19	VSS
AA20	VCC
AA21	VCC
AA22	VSS
AA23	VCC
AA24	VCC
AA25	VSS
AA26	VCC
AA27	VSS
AA28	VCCIO
AA29	VCCIO
AA30	VCCIO
AA31	VSS
AA32	SA_DQS[5]
AA33	SA_DQ[43]
AA34	SA_DQ[42]
AA35	SA_DQ[46]
AA36	SA_DQ[47]
AB1	VSS
AB2	VSS
AB3	VSS
AB4	VSS
AB5	VSS
AB6	VSS
AB7	VCCIO
AB8	VCCIO
AB9	VCCSA
AB10	VCCIO
AB11	VSS
AB12	VCCIO
AB13	VSS
AB14	VCCIO
AB15	VCCIO
AB16	VSS
AB17	VCCIO
AB18	VCCIO
AB19	VSS
AB20	VCCIO
AB21	VCCIO
AB22	VSS
AB23	VCCIO

Ball	Signal
AB24	VCCIO
AB25	VSS
AB26	VCCIO
AB27	VCCIO
AB28	VCCIO
AB29	VCCIO
AB30	VCCIO
AB31	VSS
AB32	SA_DQS#[5]
AB33	SA_DQ[44]
AB34	SA_DQ[45]
AB35	SA_DQ[41]
AB36	SA_DQ[40]
AC1	SB_DQ[1]
AC2	SB_DQ[5]
AC3	SB_DQ[0]
AC4	SB_DQ[4]
AC5	SB_DQS#[0]
AC6	VSS
AC7	VCCIO
AC8	VCCIO
AC9	VCCIO
AC10	VCCIO
AC11	VCCIO
AC12	VCCIO
AC13	VCCIO
AC14	VCCIO
AC15	VCCIO
AC16	VCCIO
AC17	VCCIO
AC18	VCCIO
AC19	VCCIO
AC20	VCCIO
AC21	VCCIO
AC22	VCCIO
AC23	VCCIO
AC24	VCCIO
AC25	VCCIO
AC26	VCCIO
AC27	VCCIO
AC28	VCCIO

Ball	Signal
AC29	VCCIO
AC30	VCCIO
AC31	VSS
AC32	VSS
AC33	VSS
AC34	VSS
AC35	VSS
AC36	VSS
AD1	SB_DQ[6]
AD2	SB_DQ[7]
AD3	SB_DQ[2]
AD4	SB_DQ[3]
AD5	SB_DQS[0]
AD6	VSS
AD7	VSS
AD8	VSS
AD9	VSS
AD10	VCCIO
AD11	VCCIO
AD12	VSS
AD13	VDDQ
AD14	VDDQ
AD15	VDDQ
AD16	VSS
AD17	VDDQ
AD18	VDDQ
AD19	VSS
AD20	VSS
AD21	VDDQ
AD22	VSS
AD23	VSS
AD24	VSS
AD25	VDDQ
AD26	VSS
AD27	VSS
AD28	VCCIO_SENSE
AD29	VSS_SENSE_VCCIO
AD30	VSS
AD31	SB_DQ[60]
AD32	SB_DQS[7]
AD33	SB_DQ[59]



Ball	Signal
AD34	SB_DQ[58]
AD35	SB_DQ[62]
AD36	SB_DQ[63]
AE1	VSS
AE2	VSS
AE3	VSS
AE4	VSS
AE5	VSS
AE6	VSS
AE7	VSS
AE8	VSS
AE9	VSS
AE10	VSS
AE11	VSS
AE12	VSS
AE13	VSS
AE14	VSS
AE15	VDDQ
AE16	VDDQ
AE17	VDDQ
AE18	VDDQ
AE19	VDDQ
AE20	VDDQ
AE21	VDDQ
AE22	VDDQ
AE23	VDDQ
AE24	VDDQ
AE25	VDDQ
AE26	VDDQ
AE27	VDDQ
AE28	VDDQ
AE29	VSS
AE30	VSS
AE31	VSS
AE32	SB_DQS#[7]
AE33	SB_DQ[61]
AE34	SB_DQ[56]
AE35	SB_DQ[57]
AE36	VSS
AF1	SA_DQ[1]
AF2	SA_DQ[5]

Ball	Signal
AF3	SA_DQ[0]
AF4	SA_DQ[4]
AF5	SA_DQS#[0]
AF6	VSS
AF7	SB_DQ[12]
AF8	SB_DQ[13]
AF9	VSS
AF10	SA_DQ[20]
AF11	SA_DQ[21]
AF12	VSS
AF13	SB_ECC_CB[4]
AF14	SB_ECC_CB[5]
AF15	VSS
AF16	SB_CKE[2]
AF17	VDDQ
AF18	RSVD_1
AF19	SM_DRAMPWROK
AF20	VDDQ
AF21	SA_MA[4]
AF22	SA_MA[2]
AF23	VDDQ
AF24	VDDQ
AF25	VSS
AF26	VDDQ
AF27	VSS
AF28	VSS
AF29	VSS
AF30	SA_DQ[34]
AF31	SA_DQ[35]
AF32	VSS
AF33	VSS
AF34	VSS
AF35	VSS
AF36	SB_DQ[51]
AG1	SA_DQ[6]
AG2	SA_DQ[7]
AG3	SA_DQ[2]
AG4	SA_DQ[3]
AG5	SA_DQS[0]
AG6	VSS
AG7	SB_DQ[8]

Ball	Signal
AG8	SB_DQ[9]
AG9	VSS
AG10	SA_DQ[16]
AG11	SA_DQ[17]
AG12	VSS
AG13	SB_ECC_CB[0]
AG14	SB_ECC_CB[1]
AG15	VSS
AG16	SB_CKE[1]
AG17	VSS
AG18	SB_MA[11]
AG19	SB_MA[7]
AG20	VSS
AG21	SB_CK[3]
AG22	SB_CK#[3]
AG23	VSS
AG24	SB_WE#
AG25	SB_CS#[0]
AG26	VSS
AG27	SB_ODT[1]
AG28	SB_ODT[3]
AG29	VSS
AG30	SA_DQ[38]
AG31	SA_DQ[39]
AG32	VSS
AG33	SB_DQS[6]
AG34	SB_DQ[50]
AG35	SB_DQ[55]
AG36	SB_DQ[54]
AH1	VSS
AH2	VSS
AH3	VSS
AH4	VSS
AH5	VSS
AH6	VSS
AH7	SB_DQS#[1]
AH8	SB_DQS[1]
AH9	VSS
AH10	SA_DQS#[2]
AH11	SA_DQS[2]
AH12	VSS



Ball	Signal
AH13	SB_DQS#[8]
AH14	SB_DQS[8]
AH15	VSS
AH16	SB_BS[2]
AH17	VDDQ
AH18	SB_MA[6]
AH19	SB_MA[4]
AH20	VDDQ
AH21	SB_CK[0]
AH22	SB_CK#[0]
AH23	VDDQ
AH24	SB_MA[10]
AH25	SB_RAS#
AH26	VDDQ
AH27	SB_CS#[1]
AH28	SB_CS#[3]
AH29	VSS
AH30	SA_DQS#[4]
AH31	SA_DQS[4]
AH32	VSS
AH33	SB_DQS#[6]
AH34	SB_DQ[53]
AH35	SB_DQ[48]
AH36	SB_DQ[49]
AJ1	SA_DQ[9]
AJ2	SA_DQ[8]
AJ3	SA_DQ[13]
AJ4	SA_DQ[12]
AJ5	SA_DQS#[1]
AJ6	VSS
AJ7	SB_DQ[15]
AJ8	SB_DQ[14]
AJ9	VSS
AJ10	SA_DQ[22]
AJ11	SA_DQ[23]
AJ12	VSS
AJ13	SB_ECC_CB[6]
AJ14	SB_ECC_CB[7]
AJ15	VSS
AJ16	SB_MA[15]
AJ17	VSS

Ball	Signal
AJ18	SB_MA[8]
AJ19	SB_MA[5]
AJ20	VSS
AJ21	SB_CK[1]
AJ22	SB_CK#[2]
AJ23	VSS
AJ24	SB_BS[1]
AJ25	SB_BS[0]
AJ26	VSS
AJ27	SB_ODT[0]
AJ28	SB_MA[13]
AJ29	VSS
AJ30	SA_DQ[33]
AJ31	SA_DQ[37]
AJ32	VSS
AJ33	VSS
AJ34	VSS
AJ35	VSS
AJ36	SB_DQ[52]
AK1	SA_DQ[14]
AK2	SA_DQ[15]
AK3	SA_DQ[10]
AK4	SA_DQ[11]
AK5	SA_DQS[1]
AK6	VSS
AK7	SB_DQ[11]
AK8	SB_DQ[10]
AK9	VSS
AK10	SA_DQ[18]
AK11	SA_DQ[19]
AK12	VSS
AK13	SB_ECC_CB[2]
AK14	SB_ECC_CB[3]
AK15	VSS
AK16	SB_DIMM_VREFDQ
AK17	VDDQ
AK18	SA_CKE[2]
AK19	SA_MA[11]
AK20	VDDQ
AK21	SB_CK#[1]
AK22	SB_CK[2]

Ball	Signal
AK23	VDDQ
AK24	SA_WE#
AK25	SA_CS#[0]
AK26	VDDQ
AK27	SA_CS#[3]
AK28	SA_ODT[3]
AK29	VSS
AK30	SA_DQ[32]
AK31	SA_DQ[36]
AK32	VSS
AK33	SB_DQ[43]
AK34	SB_DQ[42]
AK35	SB_DQ[47]
AK36	VSS
AL1	VSS
AL2	VSS
AL3	VSS
AL4	VSS
AL5	VSS
AL6	VSS
AL7	VSS
AL8	VSS
AL9	VSS
AL10	VSS
AL11	VSS
AL12	VSS
AL13	VSS
AL14	VSS
AL15	SB_CKE[0]
AL16	SA_DIMM_VREFDQ
AL17	VSS
AL18	SA_MA[14]
AL19	SA_MA[8]
AL20	VSS
AL21	VSS
AL22	SA_CK#[0]
AL23	VSS
AL24	SA_CK[3]
AL25	SA_MA[10]
AL26	VSS
AL27	SA_ODT[0]



Ball	Signal
AL28	SA_ODT[1]
AL29	VSS
AL30	VSS
AL31	VSS
AL32	VSS
AL33	SB_DQ[46]
AL34	SB_DQ[45]
AL35	SB_DQ[41]
AL36	SB_DQS[5]
AM1	SB_DQ[20]
AM2	SB_DQ[17]
AM3	SB_DQ[16]
AM4	SB_DQS#[2]
AM5	SB_DQ[21]
AM6	VSS
AM7	SB_DQS#[3]
AM8	SB_DQS[3]
AM9	VSS
AM10	SA_DQS#[3]
AM11	SA_DQS[3]
AM12	VSS
AM13	SA_DQS#[8]
AM14	SA_DQS[8]
AM15	VSS
AM16	SA_CKE[3]
AM17	VDDQ
AM18	SA_BS[2]
AM19	SA_MA[9]
AM20	VDDQ
AM21	SA_MA[1]
AM22	SA_CK[0]
AM23	VDDQ
AM24	SA_CK#[3]
AM25	SA_BS[1]
AM26	VDDQ
AM27	SA_ODT[2]
AM28	SA_MA[13]
AM29	VDDQ
AM30	VSS
AM31	SB_DQS#[4]
AM32	SB_DQS[4]

Ball	Signal
AM33	VSS
AM34	VSS
AM35	VSS
AM36	SB_DQS#[5]
AN1	VSS
AN2	SB_DQ[22]
AN3	SB_DQ[23]
AN4	SB_DQS[2]
AN5	SB_DQ[19]
AN6	VSS
AN7	SB_DQ[28]
AN8	SB_DQ[27]
AN9	VSS
AN10	SA_DQ[28]
AN11	SA_DQ[27]
AN12	VSS
AN13	SA_ECC_CB[4]
AN14	SA_ECC_CB[3]
AN15	VSS
AN16	SM_DRAMRST#
AN17	VSS
AN18	SA_MA[12]
AN19	SA_MA[7]
AN20	VSS
AN21	SA_CK[1]
AN22	SA_CK#[1]
AN23	VSS
AN24	SA_CK[2]
AN25	SA_MA[0]
AN26	VSS
AN27	SA_CAS#
AN28	SA_CS#[1]
AN29	VSS
AN30	VSS
AN31	SB_DQ[36]
AN32	SB_DQ[35]
AN33	VSS
AN34	SB_DQ[44]
AN35	SB_DQ[40]
AN36	VSS
AP1	VSS

Ball	Signal
AP2	VSS
AP3	SB_DQ[18]
AP4	VSS
AP5	VSS
AP6	VSS
AP7	SB_DQ[29]
AP8	SB_DQ[26]
AP9	VSS
AP10	SA_DQ[29]
AP11	SA_DQ[26]
AP12	VSS
AP13	SA_ECC_CB[5]
AP14	SA_ECC_CB[2]
AP15	VSS
AP16	SM_VREF
AP17	VDDQ
AP18	SA_CKE[1]
AP19	SA_MA[15]
AP20	VDDQ
AP21	SA_MA[6]
AP22	SA_MA[3]
AP23	VDDQ
AP24	SA_CK#[2]
AP25	VSS
AP26	VDDQ
AP27	SA_RAS#
AP28	SA_CS#[2]
AP29	VDDQ
AP30	VSS
AP31	SB_DQ[32]
AP32	SB_DQ[34]
AP33	VSS
AP34	VSS
AP35	VSS
AP36	VSS
AR2	VSS
AR3	VSS
AR4	VCCPLL
AR5	VCCPLL
AR6	VSS
AR7	SB_DQ[24]



Ball	Signal	Ball	Signal
AR8	SB_DQ[31]	AT16	SB_CKE[3]
AR9	VSS	AT17	VDDQ
AR10	SA_DQ[24]	AT18	SB_MA[14]
AR11	SA_DQ[31]	AT19	SB_MA[12]
AR12	VSS	AT20	VDDQ
AR13	SA_ECC_CB[0]	AT21	SB_MA[3]
AR14	SA_ECC_CB[7]	AT22	SB_MA[2]
AR15	VSS	AT23	VDDQ
AR16	SM_VREF	AT24	SM_RCOMP[1]
AR17	VSS	AT25	VDDQ
AR18	SA_CKE[0]	AT26	VDDQ
AR19	SB_MA[9]	AT27	SB_CS#[2]
AR20	VSS	AT28	SB_CAS#
AR21	SA_MA[5]	AT29	SM_RCOMP[0]
AR22	SB_MA[1]	AT30	SM_RCOMP[2]
AR23	VSS	AT31	SB_DQ[37]
AR24	SB_MA[0]	AT32	SB_DQ[39]
AR25	VSS	AT33	VSS
AR26	VSS	AT34	VSS
AR27	SA_BS[0]		
AR28	SB_ODT[2]		
AR29	VSS		
AR30	RSVD_3		
AR31	SB_DQ[33]		
AR32	SB_DQ[38]		
AR33	RSVD_2		
AR34	VSS		
AR35	VSS		
AT3	VSS		
AT4	VCCPLL		
AT5	VCCPLL		
AT6	VSS		
AT7	SB_DQ[25]		
AT8	SB_DQ[30]		
AT9	VSS		
AT10	SA_DQ[25]		
AT11	SA_DQ[30]		
AT12	VSS		
AT13	SA_ECC_CB[1]		
AT14	SA_ECC_CB[6]		
AT15	VSS		



Table 10-2. Alphabetical Signal Listing

Signal	Ball	Signal	Ball	Signal	Ball
BCLK	P6	DMI_TX#[0]	R1	PCIE1_TX[10]	J3
BCLK#	P7	DMI_TX#[1]	T1	PCIE1_TX[11]	L5
BPM#[0]	D28	DMI_TX#[2]	V2	PCIE1_TX[12]	N5
BPM#[1]	C27	DMI_TX#[3]	V1	PCIE1_TX[13]	K2
BPM#[2]	C26	PCIE_ICOMPI	J1	PCIE1_TX[14]	M1
BPM#[3]	D26	PCIE_ICOMPO	F1	PCIE1_TX[15]	M3
BPM#[4]	A26	PCIE_RCOMPO	C12	PCIE1_TX[2]	J10
BPM#[5]	B26	PCIE1_RX[0]	C9	PCIE1_TX[3]	K9
BPM#[6]	E26	PCIE1_RX[1]	A9	PCIE1_TX[4]	G9
BPM#[7]	F26	PCIE1_RX[10]	C4	PCIE1_TX[5]	H8
CATERR#	H28	PCIE1_RX[11]	D3	PCIE1_TX[6]	J7
CFG[0]	K30	PCIE1_RX[12]	E2	PCIE1_TX[7]	G6
CFG[1]	L30	PCIE1_RX[13]	F4	PCIE1_TX[8]	J5
CFG[10]	K34	PCIE1_RX[14]	G3	PCIE1_TX[9]	K6
CFG[11]	M34	PCIE1_RX[15]	G1	PCIE1_TX#[0]	G11
CFG[12]	N35	PCIE1_RX[2]	D9	PCIE1_TX#[1]	H11
CFG[13]	L35	PCIE1_RX[3]	E7	PCIE1_TX#[10]	K3
CFG[14]	M36	PCIE1_RX[4]	B7	PCIE1_TX#[11]	L4
CFG[15]	N36	PCIE1_RX[5]	C6	PCIE1_TX#[12]	N4
CFG[16]	L33	PCIE1_RX[6]	A5	PCIE1_TX#[13]	L2
CFG[17]	M32	PCIE1_RX[7]	D5	PCIE1_TX#[14]	L1
CFG[2]	N34	PCIE1_RX[8]	E4	PCIE1_TX#[15]	N3
CFG[3]	N31	PCIE1_RX[9]	B4	PCIE1_TX#[2]	J9
CFG[4]	L31	PCIE1_RX#[0]	C10	PCIE1_TX#[3]	K8
CFG[5]	L32	PCIE1_RX#[1]	A8	PCIE1_TX#[4]	G8
CFG[6]	N32	PCIE1_RX#[10]	C3	PCIE1_TX#[5]	H7
CFG[7]	K32	PCIE1_RX#[11]	D2	PCIE1_TX#[6]	J6
CFG[8]	N33	PCIE1_RX#[12]	E1	PCIE1_TX#[7]	H5
CFG[9]	L34	PCIE1_RX#[13]	F3	PCIE1_TX#[8]	J4
DMI_RX[0]	R3	PCIE1_RX#[14]	G2	PCIE1_TX#[9]	K5
DMI_RX[1]	R4	PCIE1_RX#[15]	H1	PCIE2_RX[0]	E11
DMI_RX[2]	U4	PCIE1_RX#[2]	D8	PCIE2_RX[1]	D12
DMI_RX[3]	V5	PCIE1_RX#[3]	E8	PCIE2_RX[2]	B11
DMI_RX#[0]	T3	PCIE1_RX#[4]	B8	PCIE2_RX[3]	A12
DMI_RX#[1]	T4	PCIE1_RX#[5]	C7	PCIE2_RX#[0]	D10
DMI_RX#[2]	V4	PCIE1_RX#[6]	A6	PCIE2_RX#[1]	D11
DMI_RX#[3]	W5	PCIE1_RX#[7]	D6	PCIE2_RX#[2]	B10
DMI_TX[0]	P1	PCIE1_RX#[8]	E5	PCIE2_RX#[3]	A11
DMI_TX[1]	U1	PCIE1_RX#[9]	B5	PCIE2_TX[0]	M6
DMI_TX[2]	U2	PCIE1_TX[0]	G12	PCIE2_TX[1]	L7
DMI_TX[3]	W1	PCIE1_TX[1]	H10	PCIE2_TX[2]	L11



Signal	Ball	Signal	Ball	Signal	Ball
PCIE2_TX[3]	K12	RSVD_35	G36	SA_CKE[2]	AK18
PCIE2_TX#[0]	M7	RSVD_36	F35	SA_CKE[3]	AM16
PCIE2_TX#[1]	L8	RSVD_37	E32	SA_CS#[0]	AK25
PCIE2_TX#[2]	L10	RSVD_38	E34	SA_CS#[1]	AN28
PCIE2_TX#[3]	K11	RSVD_39	D33	SA_CS#[2]	AP28
PECI	J33	RSVD_40	D36	SA_CS#[3]	AK27
PM_SYNC	E28	RSVD_41	E27	SA_DIMM_VREFDQ	AL16
PRDY#	K26	RSVD_42	C28	SA_DQ[0]	AF3
PREQ#	G29	RSVD_43	F27	SA_DQ[1]	AF1
PROC_DETECT#	F28	RSVD_44	D29	SA_DQ[10]	AK3
PROC_SELECT#	H27	RSVD_45	J31	SA_DQ[11]	AK4
PROCHOT#	H32	RSVD_46	K28	SA_DQ[12]	AJ4
RESET#	H31	RSVD_47	J29	SA_DQ[13]	AJ3
RSVD_1	AF18	RSVD_48	J27	SA_DQ[14]	AK1
RSVD_10	T6	RSVD_49	L28	SA_DQ[15]	AK2
RSVD_11	G30	RSVD_50	J36	SA_DQ[16]	AG10
RSVD_12	B30	RSVD_51	H35	SA_DQ[17]	AG11
RSVD_13	A30	RSVD_52	B35	SA_DQ[18]	AK10
RSVD_14	A28	RSVD_53	B32	SA_DQ[19]	AK11
RSVD_15	H34	RSVD_54	A34	SA_DQ[2]	AG3
RSVD_16	F33	RSVD_55	L26	SA_DQ[20]	AF10
RSVD_17	F36	RSVD_56	L27	SA_DQ[21]	AF11
RSVD_18	E35	RSVD_57	J30	SA_DQ[22]	AJ10
RSVD_19	F32	RSVD_6	N2	SA_DQ[23]	AJ11
RSVD_2	AR33	RSVD_7	J12	SA_DQ[24]	AR10
RSVD_20	D34	RSVD_8	L12	SA_DQ[25]	AT10
RSVD_21	C33	RSVD_9	R6	SA_DQ[26]	AP11
RSVD_22	B27	SA_BS[0]	AR27	SA_DQ[27]	AN11
RSVD_23	C36	SA_BS[1]	AM25	SA_DQ[28]	AN10
RSVD_24	K36	SA_BS[2]	AM18	SA_DQ[29]	AP10
RSVD_25	J35	SA_CAS#	AN27	SA_DQ[3]	AG4
RSVD_26	C35	SA_CK[0]	AM22	SA_DQ[30]	AT11
RSVD_27	C32	SA_CK[1]	AN21	SA_DQ[31]	AR11
RSVD_28	B34	SA_CK[2]	AN24	SA_DQ[32]	AK30
RSVD_29	C31	SA_CK[3]	AL24	SA_DQ[33]	AJ30
RSVD_3	AR30	SA_CK#[0]	AL22	SA_DQ[34]	AF30
RSVD_30	A31	SA_CK#[1]	AN22	SA_DQ[35]	AF31
RSVD_31	A29	SA_CK#[2]	AP24	SA_DQ[36]	AK31
RSVD_32	G34	SA_CK#[3]	AM24	SA_DQ[37]	AJ31
RSVD_33	A33	SA_CKE[0]	AR18	SA_DQ[38]	AG30
RSVD_34	G33	SA_CKE[1]	AP18	SA_DQ[39]	AG31



Signal	Ball	Signal	Ball	Signal	Ball
SA_DQ[4]	AF4	SA_DQS#[2]	AH10	SB_CK[0]	AH21
SA_DQ[40]	AB36	SA_DQS#[3]	AM10	SB_CK[1]	AJ21
SA_DQ[41]	AB35	SA_DQS#[4]	AH30	SB_CK[2]	AK22
SA_DQ[42]	AA34	SA_DQS#[5]	AB32	SB_CK[3]	AG21
SA_DQ[43]	AA33	SA_DQS#[6]	W32	SB_CK#[0]	AH22
SA_DQ[44]	AB33	SA_DQS#[7]	T32	SB_CK#[1]	AK21
SA_DQ[45]	AB34	SA_DQS#[8]	AM13	SB_CK#[2]	AJ22
SA_DQ[46]	AA35	SA_ECC_CB[0]	AR13	SB_CK#[3]	AG22
SA_DQ[47]	AA36	SA_ECC_CB[1]	AT13	SB_CKE[0]	AL15
SA_DQ[48]	W36	SA_ECC_CB[2]	AP14	SB_CKE[1]	AG16
SA_DQ[49]	W35	SA_ECC_CB[3]	AN14	SB_CKE[2]	AF16
SA_DQ[5]	AF2	SA_ECC_CB[4]	AN13	SB_CKE[3]	AT16
SA_DQ[50]	V34	SA_ECC_CB[5]	AP13	SB_CS#[0]	AG25
SA_DQ[51]	V33	SA_ECC_CB[6]	AT14	SB_CS#[1]	AH27
SA_DQ[52]	W33	SA_ECC_CB[7]	AR14	SB_CS#[2]	AT27
SA_DQ[53]	W34	SA_MA[0]	AN25	SB_CS#[3]	AH28
SA_DQ[54]	V35	SA_MA[1]	AM21	SB_DIMM_VREFDQ	AK16
SA_DQ[55]	V36	SA_MA[10]	AL25	SB_DQ[0]	AC3
SA_DQ[56]	T36	SA_MA[11]	AK19	SB_DQ[1]	AC1
SA_DQ[57]	T35	SA_MA[12]	AN18	SB_DQ[10]	AK8
SA_DQ[58]	R34	SA_MA[13]	AM28	SB_DQ[11]	AK7
SA_DQ[59]	R33	SA_MA[14]	AL18	SB_DQ[12]	AF7
SA_DQ[6]	AG1	SA_MA[15]	AP19	SB_DQ[13]	AF8
SA_DQ[60]	T33	SA_MA[2]	AF22	SB_DQ[14]	AJ8
SA_DQ[61]	T34	SA_MA[3]	AP22	SB_DQ[15]	AJ7
SA_DQ[62]	R35	SA_MA[4]	AF21	SB_DQ[16]	AM3
SA_DQ[63]	R36	SA_MA[5]	AR21	SB_DQ[17]	AM2
SA_DQ[7]	AG2	SA_MA[6]	AP21	SB_DQ[18]	AP3
SA_DQ[8]	AJ2	SA_MA[7]	AN19	SB_DQ[19]	AN5
SA_DQ[9]	AJ1	SA_MA[8]	AL19	SB_DQ[2]	AD3
SA_DQS[0]	AG5	SA_MA[9]	AM19	SB_DQ[20]	AM1
SA_DQS[1]	AK5	SA_ODT[0]	AL27	SB_DQ[21]	AM5
SA_DQS[2]	AH11	SA_ODT[1]	AL28	SB_DQ[22]	AN2
SA_DQS[3]	AM11	SA_ODT[2]	AM27	SB_DQ[23]	AN3
SA_DQS[4]	AH31	SA_ODT[3]	AK28	SB_DQ[24]	AR7
SA_DQS[5]	AA32	SA_RAS#	AP27	SB_DQ[25]	AT7
SA_DQS[6]	V32	SA_WE#	AK24	SB_DQ[26]	AP8
SA_DQS[7]	R32	SB_BS[0]	AJ25	SB_DQ[27]	AN8
SA_DQS[8]	AM14	SB_BS[1]	AJ24	SB_DQ[28]	AN7
SA_DQS#[0]	AF5	SB_BS[2]	AH16	SB_DQ[29]	AP7
SA_DQS#[1]	AJ5	SB_CAS#	AT28	SB_DQ[3]	AD4



Signal	Ball	Signal	Ball	Signal	Ball
SB_DQ[30]	AT8	SB_DQS[1]	AH8	SB_ODT[0]	AJ27
SB_DQ[31]	AR8	SB_DQS[2]	AN4	SB_ODT[1]	AG27
SB_DQ[32]	AP31	SB_DQS[3]	AM8	SB_ODT[2]	AR28
SB_DQ[33]	AR31	SB_DQS[4]	AM32	SB_ODT[3]	AG28
SB_DQ[34]	AP32	SB_DQS[5]	AL36	SB_RAS#	AH25
SB_DQ[35]	AN32	SB_DQS[6]	AG33	SB_WE#	AG24
SB_DQ[36]	AN31	SB_DQS[7]	AD32	SM_DRAMPWROK	AF19
SB_DQ[37]	AT31	SB_DQS[8]	AH14	SM_DRAMRST#	AN16
SB_DQ[38]	AR32	SB_DQS#[0]	AC5	SM_RCOMP[0]	AT29
SB_DQ[39]	AT32	SB_DQS#[1]	AH7	SM_RCOMP[1]	AT24
SB_DQ[4]	AC4	SB_DQS#[2]	AM4	SM_RCOMP[2]	AT30
SB_DQ[40]	AN35	SB_DQS#[3]	AM7	SM_VREF	AP16
SB_DQ[41]	AL35	SB_DQS#[4]	AM31	SM_VREF	AR16
SB_DQ[42]	AK34	SB_DQS#[5]	AM36	TCK	D30
SB_DQ[43]	AK33	SB_DQS#[6]	AH33	TDI	E30
SB_DQ[44]	AN34	SB_DQS#[7]	AE32	TDO	L29
SB_DQ[45]	AL34	SB_DQS#[8]	AH13	THERMTRIP#	G31
SB_DQ[46]	AL33	SB_ECC_CB[0]	AG13	TMS	F30
SB_DQ[47]	AK35	SB_ECC_CB[1]	AG14	TRST#	H26
SB_DQ[48]	AH35	SB_ECC_CB[2]	AK13	UNCOREPWROGOOD	H29
SB_DQ[49]	AH36	SB_ECC_CB[3]	AK14	VCC	A14
SB_DQ[5]	AC2	SB_ECC_CB[4]	AF13	VCC	A15
SB_DQ[50]	AG34	SB_ECC_CB[5]	AF14	VCC	A17
SB_DQ[51]	AF36	SB_ECC_CB[6]	AJ13	VCC	A18
SB_DQ[52]	AJ36	SB_ECC_CB[7]	AJ14	VCC	A20
SB_DQ[53]	AH34	SB_MA[0]	AR24	VCC	A21
SB_DQ[54]	AG36	SB_MA[1]	AR22	VCC	A23
SB_DQ[55]	AG35	SB_MA[10]	AH24	VCC	A24
SB_DQ[56]	AE34	SB_MA[11]	AG18	VCC	B14
SB_DQ[57]	AE35	SB_MA[12]	AT19	VCC	B15
SB_DQ[58]	AD34	SB_MA[13]	AJ28	VCC	B17
SB_DQ[59]	AD33	SB_MA[14]	AT18	VCC	B18
SB_DQ[6]	AD1	SB_MA[15]	AJ16	VCC	B20
SB_DQ[60]	AD31	SB_MA[2]	AT22	VCC	B21
SB_DQ[61]	AE33	SB_MA[3]	AT21	VCC	B23
SB_DQ[62]	AD35	SB_MA[4]	AH19	VCC	B24
SB_DQ[63]	AD36	SB_MA[5]	AJ19	VCC	C14
SB_DQ[7]	AD2	SB_MA[6]	AH18	VCC	C15
SB_DQ[8]	AG7	SB_MA[7]	AG19	VCC	C17
SB_DQ[9]	AG8	SB_MA[8]	AJ18	VCC	C18
SB_DQS[0]	AD5	SB_MA[9]	AR19	VCC	C20



Signal	Ball	Signal	Ball	Signal	Ball
VCC	C21	VCC	H23	VCC	N23
VCC	C23	VCC	H24	VCC	N24
VCC	C24	VCC	J14	VCC	N26
VCC	D14	VCC	J15	VCC	P12
VCC	D15	VCC	J17	VCC	P14
VCC	D17	VCC	J18	VCC	P15
VCC	D18	VCC	J20	VCC	P17
VCC	D20	VCC	J21	VCC	P18
VCC	D21	VCC	J23	VCC	P20
VCC	D23	VCC	J24	VCC	P21
VCC	D24	VCC	K14	VCC	P23
VCC	E14	VCC	K15	VCC	P24
VCC	E15	VCC	K17	VCC	P26
VCC	E17	VCC	K18	VCC	R12
VCC	E18	VCC	K20	VCC	R14
VCC	E20	VCC	K21	VCC	R15
VCC	E21	VCC	K23	VCC	R17
VCC	E23	VCC	K24	VCC	R18
VCC	E24	VCC	L14	VCC	R20
VCC	F14	VCC	L15	VCC	R21
VCC	F15	VCC	L17	VCC	R23
VCC	F17	VCC	L18	VCC	R24
VCC	F18	VCC	L20	VCC	R26
VCC	F20	VCC	L21	VCC	T12
VCC	F21	VCC	L23	VCC	T14
VCC	F23	VCC	L24	VCC	T15
VCC	F24	VCC	M14	VCC	T17
VCC	G14	VCC	M15	VCC	T18
VCC	G15	VCC	M17	VCC	T20
VCC	G17	VCC	M18	VCC	T21
VCC	G18	VCC	M20	VCC	T23
VCC	G20	VCC	M21	VCC	T24
VCC	G21	VCC	M23	VCC	T26
VCC	G23	VCC	M24	VCC	U12
VCC	G24	VCC	N12	VCC	U14
VCC	H14	VCC	N14	VCC	U15
VCC	H15	VCC	N15	VCC	U17
VCC	H17	VCC	N17	VCC	U18
VCC	H18	VCC	N18	VCC	U20
VCC	H20	VCC	N20	VCC	U21
VCC	H21	VCC	N21	VCC	U23



Signal	Ball	Signal	Ball	Signal	Ball
VCC	U24	VCC	AA26	VCCIO	Y29
VCC	U26	VCC_SENSE	M26	VCCIO	Y30
VCC	V12	VCCIO	M11	VCCIO	AA1
VCC	V14	VCCIO	M12	VCCIO	AA2
VCC	V15	VCCIO	N8	VCCIO	AA3
VCC	V17	VCCIO	N10	VCCIO	AA4
VCC	V18	VCCIO	N28	VCCIO	AA5
VCC	V20	VCCIO	N29	VCCIO	AA6
VCC	V21	VCCIO	P28	VCCIO	AA7
VCC	V23	VCCIO	P29	VCCIO	AA28
VCC	V24	VCCIO	R7	VCCIO	AA29
VCC	V26	VCCIO	R8	VCCIO	AA30
VCC	W12	VCCIO	R27	VCCIO	AB7
VCC	W14	VCCIO	R29	VCCIO	AB8
VCC	W15	VCCIO	T7	VCCIO	AB10
VCC	W17	VCCIO	T10	VCCIO	AB12
VCC	W18	VCCIO	T27	VCCIO	AB14
VCC	W20	VCCIO	T29	VCCIO	AB15
VCC	W21	VCCIO	U7	VCCIO	AB17
VCC	W23	VCCIO	U8	VCCIO	AB18
VCC	W24	VCCIO	U28	VCCIO	AB20
VCC	W26	VCCIO	U29	VCCIO	AB21
VCC	Y12	VCCIO	V7	VCCIO	AB23
VCC	Y14	VCCIO	V8	VCCIO	AB24
VCC	Y15	VCCIO	V28	VCCIO	AB26
VCC	Y17	VCCIO	V29	VCCIO	AB27
VCC	Y18	VCCIO	V30	VCCIO	AB28
VCC	Y20	VCCIO	W7	VCCIO	AB29
VCC	Y21	VCCIO	W10	VCCIO	AB30
VCC	Y23	VCCIO	W27	VCCIO	AC7
VCC	Y24	VCCIO	W29	VCCIO	AC8
VCC	Y26	VCCIO	W30	VCCIO	AC9
VCC	AA12	VCCIO	Y1	VCCIO	AC10
VCC	AA14	VCCIO	Y2	VCCIO	AC11
VCC	AA15	VCCIO	Y3	VCCIO	AC12
VCC	AA17	VCCIO	Y4	VCCIO	AC13
VCC	AA18	VCCIO	Y5	VCCIO	AC14
VCC	AA20	VCCIO	Y6	VCCIO	AC15
VCC	AA21	VCCIO	Y7	VCCIO	AC16
VCC	AA23	VCCIO	Y8	VCCIO	AC17
VCC	AA24	VCCIO	Y27	VCCIO	AC18



Signal	Ball	Signal	Ball	Signal	Ball
VCCIO	AC19	VDDQ	AD17	VDDQ	AT17
VCCIO	AC20	VDDQ	AD18	VDDQ	AT20
VCCIO	AC21	VDDQ	AD21	VDDQ	AT23
VCCIO	AC22	VDDQ	AD25	VDDQ	AT25
VCCIO	AC23	VDDQ	AE15	VDDQ	AT26
VCCIO	AC24	VDDQ	AE16	VIDALERT#	E31
VCCIO	AC25	VDDQ	AE17	VIDSCLK	E29
VCCIO	AC26	VDDQ	AE18	VIDSOUT	G26
VCCIO	AC27	VDDQ	AE19	VSS	A3
VCCIO	AC28	VDDQ	AE20	VSS	A4
VCCIO	AC29	VDDQ	AE21	VSS	A7
VCCIO	AC30	VDDQ	AE22	VSS	A10
VCCIO	AD10	VDDQ	AE23	VSS	A13
VCCIO	AD11	VDDQ	AE24	VSS	A16
VCCIO_SENSE	AD28	VDDQ	AE25	VSS	A19
VCCPLL	AR4	VDDQ	AE26	VSS	A22
VCCPLL	AR5	VDDQ	AE27	VSS	A25
VCCPLL	AT4	VDDQ	AE28	VSS	A27
VCCPLL	AT5	VDDQ	AF17	VSS	A32
VCCSA	N9	VDDQ	AF20	VSS	B2
VCCSA	P9	VDDQ	AF23	VSS	B3
VCCSA	P11	VDDQ	AF24	VSS	B6
VCCSA	R9	VDDQ	AF26	VSS	B9
VCCSA	R11	VDDQ	AH17	VSS	B12
VCCSA	T8	VDDQ	AH20	VSS	B13
VCCSA	T11	VDDQ	AH23	VSS	B16
VCCSA	U9	VDDQ	AH26	VSS	B19
VCCSA	V9	VDDQ	AK17	VSS	B22
VCCSA	V11	VDDQ	AK20	VSS	B25
VCCSA	W8	VDDQ	AK23	VSS	B28
VCCSA	W11	VDDQ	AK26	VSS	B29
VCCSA	Y9	VDDQ	AM17	VSS	B31
VCCSA	Y11	VDDQ	AM20	VSS	B33
VCCSA	AA9	VDDQ	AM23	VSS	C1
VCCSA	AB9	VDDQ	AM26	VSS	C2
VCCSA_VCCSENSE	M10	VDDQ	AM29	VSS	C5
VCCSA_VID	J26	VDDQ	AP17	VSS	C8
VCCSA_VSSSENSE	M9	VDDQ	AP20	VSS	C11
VDDQ	AD13	VDDQ	AP23	VSS	C13
VDDQ	AD14	VDDQ	AP26	VSS	C16
VDDQ	AD15	VDDQ	AP29	VSS	C19



Signal	Ball	Signal	Ball	Signal	Ball
VSS	C22	VSS	F22	VSS	J32
VSS	C25	VSS	F25	VSS	J34
VSS	C29	VSS	F29	VSS	K1
VSS	C30	VSS	F31	VSS	K4
VSS	C34	VSS	F34	VSS	K7
VSS	D1	VSS	G4	VSS	K10
VSS	D4	VSS	G5	VSS	K13
VSS	D7	VSS	G7	VSS	K16
VSS	D13	VSS	G10	VSS	K19
VSS	D16	VSS	G13	VSS	K22
VSS	D19	VSS	G16	VSS	K25
VSS	D22	VSS	G19	VSS	K27
VSS	D25	VSS	G22	VSS	K29
VSS	D27	VSS	G25	VSS	K31
VSS	D31	VSS	G27	VSS	K33
VSS	D32	VSS	G28	VSS	K35
VSS	D35	VSS	G32	VSS	L3
VSS	E3	VSS	G35	VSS	L6
VSS	E6	VSS	H2	VSS	L9
VSS	E9	VSS	H3	VSS	L13
VSS	E10	VSS	H4	VSS	L16
VSS	E12	VSS	H6	VSS	L19
VSS	E13	VSS	H9	VSS	L22
VSS	E16	VSS	H12	VSS	L25
VSS	E19	VSS	H13	VSS	L36
VSS	E22	VSS	H16	VSS	M2
VSS	E25	VSS	H19	VSS	M4
VSS	E33	VSS	H22	VSS	M5
VSS	E36	VSS	H25	VSS	M8
VSS	F2	VSS	H30	VSS	M13
VSS	F5	VSS	H33	VSS	M16
VSS	F6	VSS	H36	VSS	M19
VSS	F7	VSS	J2	VSS	M22
VSS	F8	VSS	J8	VSS	M25
VSS	F9	VSS	J11	VSS	M28
VSS	F10	VSS	J13	VSS	M29
VSS	F11	VSS	J16	VSS	M30
VSS	F12	VSS	J19	VSS	M31
VSS	F13	VSS	J22	VSS	M33
VSS	F16	VSS	J25	VSS	M35
VSS	F19	VSS	J28	VSS	N1



Signal	Ball	Signal	Ball	Signal	Ball
VSS	N6	VSS	T5	VSS	W6
VSS	N7	VSS	T9	VSS	W9
VSS	N11	VSS	T13	VSS	W13
VSS	N13	VSS	T16	VSS	W16
VSS	N16	VSS	T19	VSS	W19
VSS	N19	VSS	T22	VSS	W22
VSS	N22	VSS	T25	VSS	W25
VSS	N25	VSS	T28	VSS	W28
VSS	N27	VSS	T30	VSS	W31
VSS	N30	VSS	T31	VSS	Y10
VSS	P2	VSS	U3	VSS	Y13
VSS	P3	VSS	U5	VSS	Y16
VSS	P4	VSS	U6	VSS	Y19
VSS	P5	VSS	U10	VSS	Y22
VSS	P8	VSS	U11	VSS	Y25
VSS	P10	VSS	U13	VSS	Y28
VSS	P13	VSS	U16	VSS	Y31
VSS	P16	VSS	U19	VSS	Y32
VSS	P19	VSS	U22	VSS	Y33
VSS	P22	VSS	U25	VSS	Y34
VSS	P25	VSS	U27	VSS	Y35
VSS	P27	VSS	U30	VSS	Y36
VSS	P30	VSS	U31	VSS	AA8
VSS	P31	VSS	U32	VSS	AA10
VSS	P32	VSS	U33	VSS	AA11
VSS	P33	VSS	U34	VSS	AA13
VSS	P34	VSS	U35	VSS	AA16
VSS	P35	VSS	U36	VSS	AA19
VSS	P36	VSS	V3	VSS	AA22
VSS	R2	VSS	V6	VSS	AA25
VSS	R5	VSS	V10	VSS	AA27
VSS	R10	VSS	V13	VSS	AA31
VSS	R13	VSS	V16	VSS	AB1
VSS	R16	VSS	V19	VSS	AB2
VSS	R19	VSS	V22	VSS	AB3
VSS	R22	VSS	V25	VSS	AB4
VSS	R25	VSS	V27	VSS	AB5
VSS	R28	VSS	V31	VSS	AB6
VSS	R30	VSS	W2	VSS	AB11
VSS	R31	VSS	W3	VSS	AB13
VSS	T2	VSS	W4	VSS	AB16



Signal	Ball	Signal	Ball	Signal	Ball
VSS	AB19	VSS	AE31	VSS	AJ23
VSS	AB22	VSS	AE36	VSS	AJ26
VSS	AB25	VSS	AF6	VSS	AJ29
VSS	AB31	VSS	AF9	VSS	AJ32
VSS	AC6	VSS	AF12	VSS	AJ33
VSS	AC31	VSS	AF15	VSS	AJ34
VSS	AC32	VSS	AF25	VSS	AJ35
VSS	AC33	VSS	AF27	VSS	AK6
VSS	AC34	VSS	AF28	VSS	AK9
VSS	AC35	VSS	AF29	VSS	AK12
VSS	AC36	VSS	AF32	VSS	AK15
VSS	AD6	VSS	AF33	VSS	AK29
VSS	AD7	VSS	AF34	VSS	AK32
VSS	AD8	VSS	AF35	VSS	AK36
VSS	AD9	VSS	AG6	VSS	AL1
VSS	AD12	VSS	AG9	VSS	AL2
VSS	AD16	VSS	AG12	VSS	AL3
VSS	AD19	VSS	AG15	VSS	AL4
VSS	AD20	VSS	AG17	VSS	AL5
VSS	AD22	VSS	AG20	VSS	AL6
VSS	AD23	VSS	AG23	VSS	AL7
VSS	AD24	VSS	AG26	VSS	AL8
VSS	AD26	VSS	AG29	VSS	AL9
VSS	AD27	VSS	AG32	VSS	AL10
VSS	AD30	VSS	AH1	VSS	AL11
VSS	AE1	VSS	AH2	VSS	AL12
VSS	AE2	VSS	AH3	VSS	AL13
VSS	AE3	VSS	AH4	VSS	AL14
VSS	AE4	VSS	AH5	VSS	AL17
VSS	AE5	VSS	AH6	VSS	AL20
VSS	AE6	VSS	AH9	VSS	AL21
VSS	AE7	VSS	AH12	VSS	AL23
VSS	AE8	VSS	AH15	VSS	AL26
VSS	AE9	VSS	AH29	VSS	AL29
VSS	AE10	VSS	AH32	VSS	AL30
VSS	AE11	VSS	AJ6	VSS	AL31
VSS	AE12	VSS	AJ9	VSS	AL32
VSS	AE13	VSS	AJ12	VSS	AM6
VSS	AE14	VSS	AJ15	VSS	AM9
VSS	AE29	VSS	AJ17	VSS	AM12
VSS	AE30	VSS	AJ20	VSS	AM15



Signal	Ball	Signal	Ball
VSS	AM30	VSS	AR26
VSS	AM33	VSS	AR29
VSS	AM34	VSS	AR34
VSS	AM35	VSS	AR35
VSS	AN1	VSS	AT3
VSS	AN6	VSS	AT6
VSS	AN9	VSS	AT9
VSS	AN12	VSS	AT12
VSS	AN15	VSS	AT15
VSS	AN17	VSS	AT33
VSS	AN20	VSS	AT34
VSS	AN23	VSS_SENSE	M27
VSS	AN26	VSS_SENSE_VCCIO	AD29
VSS	AN29		
VSS	AN30		
VSS	AN33		
VSS	AN36		
VSS	AP1		
VSS	AP2		
VSS	AP4		
VSS	AP5		
VSS	AP6		
VSS	AP9		
VSS	AP12		
VSS	AP15		
VSS	AP25		
VSS	AP30		
VSS	AP33		
VSS	AP34		
VSS	AP35		
VSS	AP36		
VSS	AR2		
VSS	AR3		
VSS	AR6		
VSS	AR9		
VSS	AR12		
VSS	AR15		
VSS	AR17		
VSS	AR20		
VSS	AR23		
VSS	AR25		



Figure 10-1. Ball Map (Bottom View, Upper Left Side)

	A	B	C	D	E	F	G	H	J	K	L	M	N	P	R	T	U	V
1			VSS	VSS	PCIE1_RX#[12]	PCIE1_COMPO	PCIE1_RX#[15]	PCIE1_RX#[15]	PCIE1_COMPI	VSS	PCIE1_TX#[14]	PCIE1_TX#[14]	VSS	DMI_TX#[0]	DMI_TX#[0]	DMI_TX#[1]	DMI_TX#[1]	DMI_TX#[3]
2		VSS	VSS	PCIE1_RX#[11]	PCIE1_RX#[12]	VSS	PCIE1_RX#[14]	VSS	VSS	PCIE1_TX#[13]	PCIE1_TX#[13]	VSS	RSVD_6	VSS	VSS	VSS	DMI_TX#[2]	DMI_TX#[2]
3	VSS	VSS	PCIE1_RX#[10]	PCIE1_RX#[11]	VSS	PCIE1_RX#[13]	PCIE1_RX#[14]	VSS	PCIE1_TX#[10]	PCIE1_TX#[10]	VSS	PCIE1_TX#[15]	PCIE1_TX#[15]	VSS	DMI_RX#[0]	DMI_RX#[0]	VSS	VSS
4	VSS	PCIE1_RX#[9]	PCIE1_RX#[10]	VSS	PCIE1_RX#[8]	PCIE1_RX#[13]	VSS	VSS	PCIE1_TX#[8]	VSS	PCIE1_TX#[11]	VSS	PCIE1_TX#[12]	VSS	DMI_RX#[1]	DMI_RX#[1]	DMI_RX#[2]	DMI_RX#[2]
5	PCIE1_RX#[6]	PCIE1_RX#[9]	VSS	PCIE1_RX#[7]	PCIE1_RX#[8]	VSS	VSS	PCIE1_TX#[7]	PCIE1_TX#[8]	PCIE1_TX#[9]	PCIE1_TX#[11]	VSS	PCIE1_TX#[12]	VSS	VSS	VSS	VSS	DMI_RX#[3]
6	PCIE1_RX#[6]	VSS	PCIE1_RX#[5]	PCIE1_RX#[7]	VSS	VSS	PCIE1_TX#[7]	VSS	PCIE1_TX#[6]	PCIE1_TX#[9]	VSS	PCIE2_TX#[0]	VSS	BCLK#	RSVD_9	RSVD_10	VSS	VSS
7	VSS	PCIE1_RX#[4]	PCIE1_RX#[5]	VSS	PCIE1_RX#[3]	VSS	VSS	PCIE1_TX#[5]	PCIE1_TX#[6]	VSS	PCIE2_TX#[1]	PCIE2_TX#[0]	VSS	BCLK	VCCIO	VCCIO	VCCIO	VCCIO
8	PCIE1_RX#[1]	PCIE1_RX#[4]	VSS	PCIE1_RX#[2]	PCIE1_RX#[3]	VSS	PCIE1_TX#[4]	PCIE1_TX#[5]	VSS	PCIE1_TX#[3]	PCIE2_TX#[1]	VSS	VCCIO	VSS	VCCIO	VCCSA	VCCIO	VCCIO
9	PCIE1_RX#[1]	VSS	PCIE1_RX#[0]	PCIE1_RX#[2]	VSS	VSS	PCIE1_TX#[4]	VSS	PCIE1_TX#[2]	PCIE1_TX#[3]	VSS	VCCSA_VSSSE	VCCSA	VCCSA	VCCSA	VSS	VCCSA	VCCSA
10	VSS	PCIE2_RX#[2]	PCIE1_RX#[0]	PCIE2_RX#[0]	VSS	VSS	VSS	PCIE1_TX#[1]	PCIE1_TX#[2]	VSS	PCIE2_TX#[2]	VCCSA_VCCSE	VCCIO	VSS	VSS	VCCIO	VSS	VSS
11	PCIE2_RX#[3]	PCIE2_RX#[2]	VSS	PCIE2_RX#[1]	PCIE2_RX#[0]	VSS	PCIE1_TX#[0]	PCIE1_TX#[1]	VSS	PCIE2_TX#[3]	PCIE2_TX#[2]	VCC	VSS	VCCSA	VCCSA	VCCSA	VSS	VCCSA
12	PCIE2_RX#[3]	VSS	PCIE1_COMPO	PCIE2_RX#[1]	VSS	VSS	PCIE1_TX#[0]	VSS	RSVD_7	PCIE2_TX#[3]	RSVD_8	VCC	VCC	VCC	VCC	VCC	VCC	VCC
13	VSS	VSS	VSS	VSS	VSS	VSS	VSS	VSS	VSS	VSS	VSS	VSS	VSS	VSS	VSS	VSS	VSS	VSS
14	VCC	VCC	VCC	VCC	VCC	VCC	VCC	VCC	VCC	VCC	VCC	VCC	VCC	VCC	VCC	VCC	VCC	VCC
15	VCC	VCC	VCC	VCC	VCC	VCC	VCC	VCC	VCC	VCC	VCC	VCC	VCC	VCC	VCC	VCC	VCC	VCC
16	VSS	VSS	VSS	VSS	VSS	VSS	VSS	VSS	VSS	VSS	VSS	VSS	VSS	VSS	VSS	VSS	VSS	VSS
17	VCC	VCC	VCC	VCC	VCC	VCC	VCC	VCC	VCC	VCC	VCC	VCC	VCC	VCC	VCC	VCC	VCC	VCC
18	VCC	VCC	VCC	VCC	VCC	VCC	VCC	VCC	VCC	VCC	VCC	VCC	VCC	VCC	VCC	VCC	VCC	VCC



Figure 10-2. Ball Map (Bottom View, Upper Right Side)

W	Y	AA	AB	AC	AD	AE	AF	AG	AH	AJ	AK	AL	AM	AN	AP	AR	AT	
DMI_TX [3]	VCCIO	VCCIO	VSS	SB_DO[1]	SB_DO[6]	VSS	SA_DQ[1]	SA_DQ[6]	VSS	SA_DQ[9]	SA_DQ[14]	VSS	SB_DO[20]	VSS	VSS			1
VSS	VCCIO	VCCIO	VSS	SB_DO[5]	SB_DO[7]	VSS	SA_DQ[5]	SA_DQ[7]	VSS	SA_DQ[8]	SA_DQ[15]	VSS	SB_DO[17]	SB_DO[22]	VSS	VSS		2
VSS	VCCIO	VCCIO	VSS	SB_DO[0]	SB_DO[2]	VSS	SA_DQ[0]	SA_DQ[2]	VSS	SA_DQ[13]	SA_DQ[10]	VSS	SB_DO[16]	SB_DO[23]	SB_DO[18]	VSS	VSS	3
VSS	VCCIO	VCCIO	VSS	SB_DO[4]	SB_DO[3]	VSS	SA_DQ[4]	SA_DQ[3]	VSS	SA_DQ[12]	SA_DQ[11]	VSS	SB_DO S#[2]	SB_DO S[2]	VSS	VCCPLL	VCCPLL	4
DMI_RX #[3]	VCCIO	VCCIO	VSS	SB_DQ S#[0]	SB_DQ S[0]	VSS	SA_DQ S#[0]	SA_DQ S[0]	VSS	SA_DQ S#[1]	SA_DQ S[1]	VSS	SB_DO[21]	SB_DO[19]	VSS	VCCPLL	VCCPLL	5
VSS	VCCIO	VCCIO	VSS	VSS	VSS	VSS	VSS	VSS	VSS	VSS	VSS	VSS	VSS	VSS	VSS	VSS	VSS	6
VCCIO	VCCIO	VCCIO	VCCIO	VCCIO	VSS	VSS	SB_DO[12]	SB_DO[8]	SB_DO S#[1]	SB_DO[15]	SB_DO[11]	VSS	SB_DO S#[3]	SB_DO[28]	SB_DO[29]	SB_DO[24]	SB_DO[25]	7
VCCSA	VCCIO	VSS	VCCIO	VCCIO	VSS	VSS	SB_DO[13]	SB_DO[9]	SB_DO S[1]	SB_DO[14]	SB_DO[10]	VSS	SB_DO S[3]	SB_DO[27]	SB_DO[26]	SB_DO[31]	SB_DO[30]	8
VSS	VCCSA	VCCSA	VCCSA	VCCIO	VSS	VSS	VSS	VSS	VSS	VSS	VSS	VSS	VSS	VSS	VSS	VSS	VSS	9
VCCIO	VSS	VSS	VCCIO	VCCIO	VCCIO	VSS	SA_DQ[20]	SA_DQ[16]	SA_DQ S#[2]	SA_DQ[22]	SA_DQ[18]	VSS	SA_DQ S#[3]	SA_DQ[28]	SA_DQ[29]	SA_DQ[24]	SA_DQ[25]	10
VCCSA	VCCSA	VSS	VSS	VCCIO	VCCIO	VSS	SA_DQ[21]	SA_DQ[17]	SA_DQ S[2]	SA_DQ[23]	SA_DQ[19]	VSS	SA_DQ S[3]	SA_DQ[27]	SA_DQ[26]	SA_DQ[31]	SA_DQ[30]	11
VCC	VCC	VCC	VCCIO	VCCIO	VSS	VSS	VSS	VSS	VSS	VSS	VSS	VSS	VSS	VSS	VSS	VSS	VSS	12
VSS	VSS	VSS	VSS	VCCIO	VCCIO	VSS	SB_ECC _CB[4]	SB_ECC _CB[0]	SB_DO S#[8]	SB_ECC _CB[6]	SB_ECC _CB[2]	VSS	SA_DQ S#[8]	SA_ECC _CB[4]	SA_ECC _CB[5]	SA_ECC _CB[0]	SA_ECC _CB[1]	13
VCC	VCC	VCC	VCCIO	VCCIO	VCCIO	VSS	SB_ECC _CB[5]	SB_ECC _CB[1]	SB_DO S[8]	SB_ECC _CB[7]	SB_ECC _CB[3]	VSS	SA_DQ S[8]	SA_ECC _CB[3]	SA_ECC _CB[2]	SA_ECC _CB[7]	SA_ECC _CB[6]	14
VCC	VCC	VCC	VCCIO	VCCIO	VDDQ	VDDQ	VSS	VSS	VSS	VSS	VSS	SB_CKE [0]	VSS	VSS	VSS	VSS	VSS	15
VSS	VSS	VSS	VSS	VCCIO	VSS	VDDQ	SB_CKE [2]	SB_CKE [1]	SB_BS[2]	SB_MA[15]	SB_DIM M_VREF DO	SA_DIM M_VREF DO	SA_CKE [3]	SM_DR AMRST #	SM_VR EF	SM_VR EF	SB_CKE [3]	16
VCC	VCC	VCC	VCCIO	VCCIO	VDDQ	VDDQ	VDDQ	VSS	VDDQ	VSS	VDDQ	VSS	VDDQ	VSS	VDDQ	VSS	VDDQ	17
VCC	VCC	VCC	VCCIO	VCCIO	VDDQ	VDDQ	RSVD_1	SB_MA[11]	SB_MA[6]	SB_MA[8]	SA_CKE [2]	SA_MA[14]	SA_BS[2]	SA_MA[12]	SA_CKE [1]	SA_CKE [0]	SB_MA[14]	18

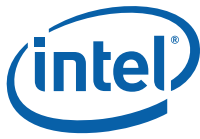

Figure 10-3. Ball Map (Bottom View, Lower Left Side)

19	VSS	VSS	VSS	VSS	VSS	VSS	VSS	VSS	VSS	VSS	VSS	VSS	VSS	VSS	VSS	VSS	VSS	VSS
20	VCC	VCC	VCC	VCC	VCC	VCC	VCC	VCC	VCC	VCC	VCC	VCC	VCC	VCC	VCC	VCC	VCC	VCC
21	VCC	VCC	VCC	VCC	VCC	VCC	VCC	VCC	VCC	VCC	VCC	VCC	VCC	VCC	VCC	VCC	VCC	VCC
22	VSS	VSS	VSS	VSS	VSS	VSS	VSS	VSS	VSS	VSS	VSS	VSS	VSS	VSS	VSS	VSS	VSS	VSS
23	VCC	VCC	VCC	VCC	VCC	VCC	VCC	VCC	VCC	VCC	VCC	VCC	VCC	VCC	VCC	VCC	VCC	VCC
24	VCC	VCC	VCC	VCC	VCC	VCC	VCC	VCC	VCC	VCC	VCC	VCC	VCC	VCC	VCC	VCC	VCC	VCC
25	VSS	VSS	VSS	VSS	VSS	VSS	VSS	VSS	VSS	VSS	VSS	VSS	VSS	VSS	VSS	VSS	VSS	VSS
26	BPM#[4]	BPM#[5]	BPM#[2]	BPM#[3]	BPM#[6]	BPM#[7]	VIDSOUT	TRST#	VCCSAVID	PRDY#	RSVD_55	VCC_SENSE	VCC	VCC	VCC	VCC	VCC	VCC
27	VSS	RSVD_22	BPM#[1]	VSS	RSVD_41	RSVD_43	VSS	PROC_SELECT#	RSVD_48	VSS	RSVD_56	VSS_SENSE	VSS	VSS	VCCIO	VCCIO	VSS	VSS
28	RSVD_14	VSS	RSVD_42	BPM#[0]	PM_SYNC	PROC_DETECT#	VSS	CATERR#	VSS	RSVD_46	RSVD_49	VSS	VCCIO	VCCIO	VSS	VSS	VCCIO	VCCIO
29	RSVD_31	VSS	VSS	RSVD_44	VIDSCLK	VSS	PREQ#	UNCOREPWROD	RSVD_47	VSS	TDO	VSS	VCCIO	VCCIO	VCCIO	VCCIO	VCCIO	VCCIO
30	RSVD_13	RSVD_12	VSS	TCK	TDI	TMS	RSVD_11	VSS	RSVD_57	CFG[0]	CFG[1]	VSS	VSS	VSS	VSS	VSS	VSS	VCCIO
31	RSVD_30	VSS	RSVD_29	VSS	VIDALERT#	VSS	THERMTRIP#	RESET#	RSVD_45	VSS	CFG[4]	VSS	CFG[3]	VSS	VSS	VSS	VSS	VSS
32	VSS	RSVD_53	RSVD_27	VSS	RSVD_37	RSVD_19	VSS	PROCHOT#	VSS	CFG[7]	CFG[5]	CFG[17]	CFG[6]	VSS	SA_DQS[7]	SA_DQS#[7]	VSS	SA_DQS[6]
33	RSVD_33	VSS	RSVD_21	RSVD_39	VSS	RSVD_16	RSVD_34	VSS	PECI	VSS	CFG[16]	VSS	CFG[8]	VSS	SA_DQ[59]	SA_DQ[60]	VSS	SA_DQ[51]
34	RSVD_54	RSVD_28	VSS	RSVD_20	RSVD_38	VSS	RSVD_32	RSVD_15	VSS	CFG[10]	CFG[9]	CFG[11]	CFG[2]	VSS	SA_DQ[58]	SA_DQ[61]	VSS	SA_DQ[50]
35		RSVD_52	RSVD_26	VSS	RSVD_18	RSVD_36	VSS	RSVD_51	RSVD_25	VSS	CFG[13]	VSS	CFG[12]	VSS	SA_DQ[62]	SA_DQ[57]	VSS	SA_DQ[54]
36			RSVD_23	RSVD_40	VSS	RSVD_17	RSVD_35	VSS	RSVD_50	RSVD_24	VSS	CFG[14]	CFG[15]	VSS	SA_DQ[63]	SA_DQ[56]	VSS	SA_DQ[55]
	A	B	C	D	E	F	G	H	J	K	L	M	N	P	R	T	U	V



Figure 10-4. Ball Map (Bottom View, Lower Right Side)

VSS	VSS	VSS	VSS	VCCIO	VSS	VDDQ	SM_DR AMPVWR OK	SB_MA [7]	SB_MA [4]	SB_MA [5]	SA_MA [11]	SA_MA [8]	SA_MA [9]	SA_MA [7]	SA_MA [15]	SB_MA [9]	SB_MA [12]	19
VCC	VCC	VCC	VCCIO	VCCIO	VSS	VDDQ	VDDQ	VSS	VDDQ	VSS	VDDQ	VSS	VDDQ	VSS	VDDQ	VSS	VDDQ	20
VCC	VCC	VCC	VCCIO	VCCIO	VDDQ	VDDQ	SA_MA [4]	SB_CK [3]	SB_CK [0]	SB_CK [1]	SB_CK # [1]	VSS	SA_MA [1]	SA_CK [1]	SA_MA [6]	SA_MA [5]	SB_MA [3]	21
VSS	VSS	VSS	VSS	VCCIO	VSS	VDDQ	SA_MA [2]	SB_CK # [3]	SB_CK # [0]	SB_CK # [2]	SB_CK [2]	SA_CK # [0]	SA_CK [0]	SA_CK # [1]	SA_MA [3]	SB_MA [1]	SB_MA [2]	22
VCC	VCC	VCC	VCCIO	VCCIO	VSS	VDDQ	VDDQ	VSS	VDDQ	VSS	VDDQ	VSS	VDDQ	VSS	VDDQ	VSS	VDDQ	23
VCC	VCC	VCC	VCCIO	VCCIO	VSS	VDDQ	VDDQ	SB_WE #	SB_MA [10]	SB_BS [1]	SA_WE #	SA_CK [3]	SA_CK # [3]	SA_CK [2]	SA_CK # [2]	SB_MA [0]	SM_RC OMP [1]	24
VSS	VSS	VSS	VSS	VCCIO	VDDQ	VDDQ	VSS	SB_CS # [0]	SB_RA S #	SB_BS [0]	SA_CS # [0]	SA_MA [10]	SA_BS [1]	SA_MA [0]	VSS	VSS	VDDQ	25
VCC	VCC	VCC	VCCIO	VCCIO	VSS	VDDQ	VDDQ	VSS	VDDQ	VSS	VDDQ	VSS	VDDQ	VSS	VDDQ	VSS	VDDQ	26
VCCIO	VCCIO	VSS	VCCIO	VCCIO	VSS	VDDQ	VSS	SB_OD T [1]	SB_CS # [1]	SB_OD T [0]	SA_CS # [3]	SA_OD T [0]	SA_OD T [2]	SA_CA S #	SA_RA S #	SA_BS [0]	SB_CS # [2]	27
VSS	VSS	VCCIO	VCCIO	VCCIO	VCCIO_SENSE_VCCIO	VDDQ	VSS	SB_OD T [3]	SB_CS # [3]	SB_MA [13]	SA_OD T [3]	SA_OD T [1]	SA_MA [13]	SA_CS # [1]	SA_CS # [2]	SB_OD T [2]	SB_CA S #	28
VCCIO	VCCIO	VCCIO	VCCIO	VCCIO	VSS	VSS	VSS	VSS	VSS	VSS	VSS	VSS	VDDQ	VSS	VDDQ	VSS	SM_RC OMP [0]	29
VCCIO	VCCIO	VCCIO	VCCIO	VCCIO	VSS	VSS	SA_DQ [34]	SA_DQ [38]	SA_DQ S # [4]	SA_DQ [33]	SA_DQ [32]	VSS	VSS	VSS	VSS	RSVD_3	SM_RC OMP [2]	30
VSS	VSS	VSS	VSS	VSS	SB_DQ [60]	VSS	SA_DQ [35]	SA_DQ [39]	SA_DQ S [4]	SA_DQ [37]	SA_DQ [36]	VSS	SB_DQ S # [4]	SB_DQ [36]	SB_DQ [32]	SB_DQ [33]	SB_DQ [37]	31
SA_DQ S # [6]	VSS	SA_DQ S [5]	SA_DQ S # [5]	VSS	SB_DQ S [7]	SB_DQ S # [7]	VSS	VSS	VSS	VSS	VSS	VSS	SB_DQ S [4]	SB_DQ [35]	SB_DQ [34]	SB_DQ [38]	SB_DQ [39]	32
SA_DQ [52]	VSS	SA_DQ [43]	SA_DQ [44]	VSS	SB_DQ [59]	SB_DQ [61]	VSS	SB_DQ S [6]	SB_DQ S # [6]	VSS	SB_DQ [43]	SB_DQ [46]	VSS	VSS	VSS	RSVD_2	VSS	33
SA_DQ [53]	VSS	SA_DQ [42]	SA_DQ [45]	VSS	SB_DQ [58]	SB_DQ [56]	VSS	SB_DQ [50]	SB_DQ [53]	VSS	SB_DQ [42]	SB_DQ [45]	VSS	SB_DQ [44]	VSS	VSS	VSS	34
SA_DQ [49]	VSS	SA_DQ [46]	SA_DQ [41]	VSS	SB_DQ [62]	SB_DQ [57]	VSS	SB_DQ [55]	SB_DQ [48]	VSS	SB_DQ [47]	SB_DQ [41]	VSS	SB_DQ [40]	VSS	VSS		35
SA_DQ [48]	VSS	SA_DQ [47]	SA_DQ [40]	VSS	SB_DQ [63]	VSS	SB_DQ [51]	SB_DQ [54]	SB_DQ [49]	SB_DQ [52]	VSS	SB_DQ S [5]	SB_DQ S # [5]	VSS	VSS			36
W	Y	AA	AB	AC	AD	AE	AF	AG	AH	AJ	AK	AL	AM	AN	AP	AR	AT	



10.2 Package Mechanical Information

The following section contains the mechanical drawings for the processor. The processor utilizes a 37.5 x 37.5 mm, FC-BGA package. There are two versions of die available on this package — a 4-Core-die version and a 2-Core-die version. The processor SKUs and their corresponding die-type are provided in [Table 5-1, “Base Features by SKU”](#) on page 45.

The primary mechanical difference between the two products is the size of the die on the substrate. The pinout, package substrate and solder ball pattern are the same between the two packages.

See the following package drawings for the die size of the two processor packages. [Figure 10-5](#) shows the 4-Core Die Mechanical Package and [Figure 10-6](#) shows the 2-Core Die / 1-Core Die Mechanical Package. The dimensions in the figures are in millimeters.

Remember to check the size differences between the two dies when designing your thermal solution.



Figure 10-5. Processor 4-Core Die Mechanical Package

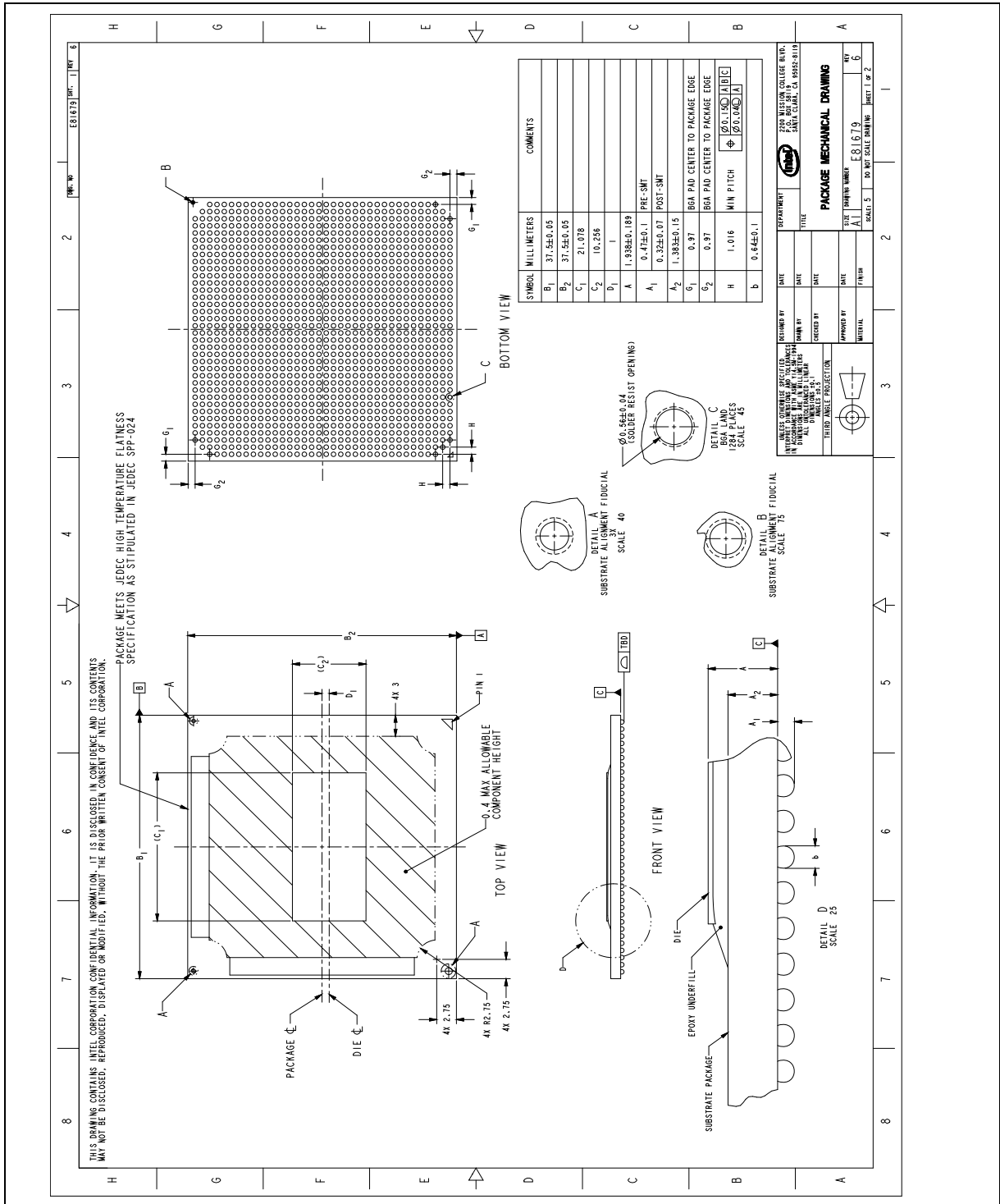
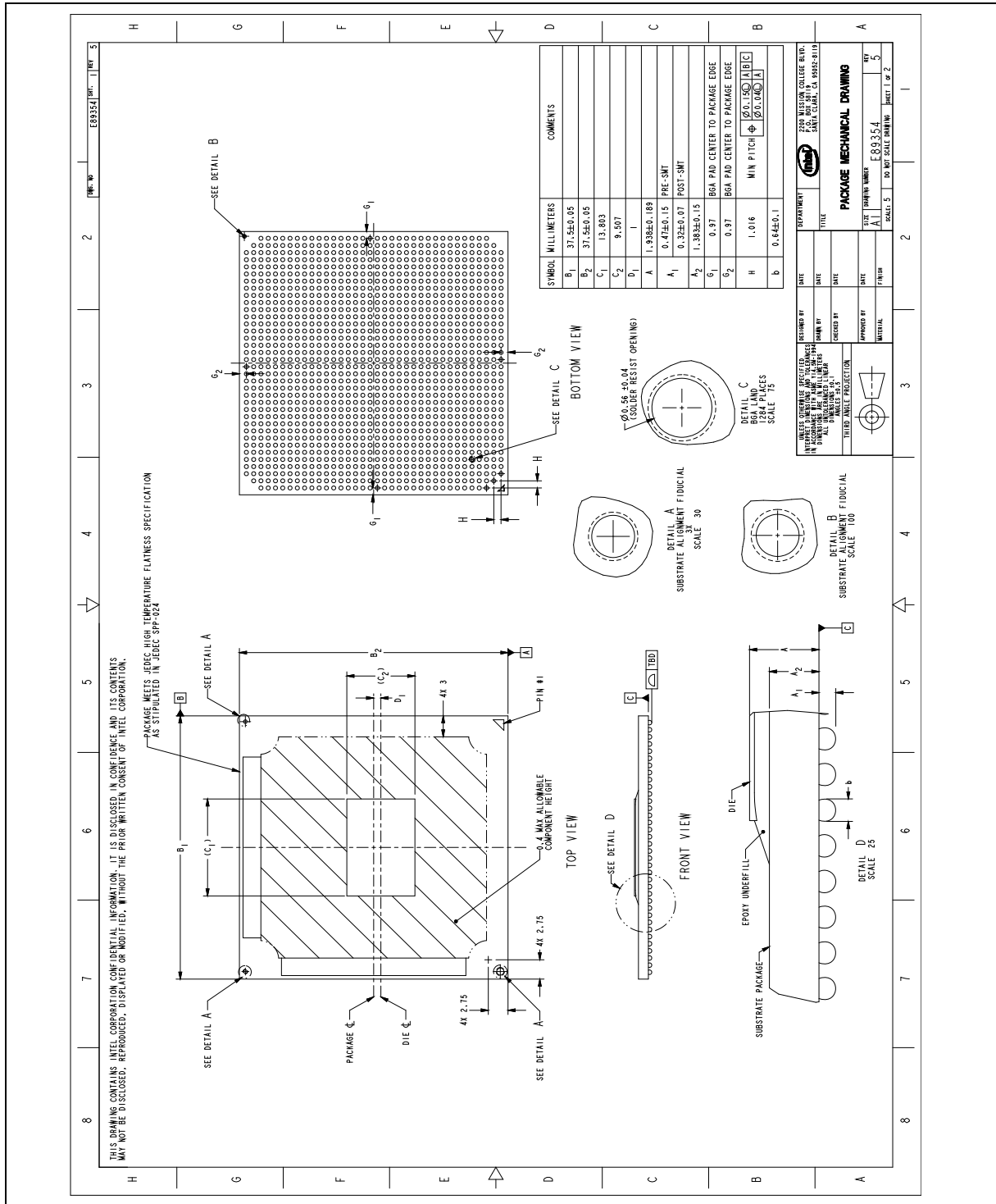

Figure 10-6. Processor 2-Core Die / 1-Core Die Mechanical Package





§ §





11.0 Processor Configuration Registers

This section contains register information that is specific to the Intel® Xeon®, Intel® Core™, Intel® Pentium® and Intel® Celeron® Processors for Communications Infrastructure. For other register details see the latest version of the *2nd Generation Intel® Core™ Processor Family Mobile Datasheet – Volume 2*.

Note: The processor does not include the Integrated Display Engine or the Graphics Processor Unit (GPU). Disregard references to graphics and Intel® Turbo Boost in the *2nd Generation Intel® Core™ Processor Family Mobile Datasheet – Volume 2*.

Table 11-1 shows the register-related terminology that is used in this document.

Table 11-1. Register Terminology

Item	Description
RO	Read Only: These bits can only be read by software, writes have no effect. The value of the bits is determined by the hardware only.
RW	Read/Write: These bits can be read and written by software.
RW1C	Read / Write 1 to Clear: These bits can be read and cleared by software. Writing a '1' to a bit will clear it, while writing a '0' to a bit has no effect. Hardware sets these bits.
RW0C	Read/Write 0 to Clear: These bits can be read and cleared by software. Writing a '0' to a bit will clear it, while writing a '1' to a bit has no effect. Hardware sets these bits.
RW1S	Read / Write 1 to Set: These bits can be read and set by software. Writing a '1' to a bit will set it, while writing a '0' to a bit has no effect. Hardware clears these bits.
RsvdP	Reserved and Preserved: These bits are reserved for future RW implementations and their value must not be modified by software. When writing to these bits, software must preserve the value read. When SW updates a register that has RsvdP fields, it must read the register value first so that the appropriate merge between the RsvdP and updated fields will occur.
RsvdZ	Reserved and Zero: These bits are reserved for future RW1C implementations. SW must use 0 for writes.
WO	Write Only: These bits can only be written by software, reads return zero. NOTE: Use of this attribute type is deprecated and can only be used to describe bits without persistent state.
RC	Read Clear: These bits can only be read by software, but a read causes the bits to be cleared. Hardware sets these bits. NOTE: Use of this attribute type is only allowed on legacy functions, as side-effects on reads are not desirable
RSW1C	Read Set / Write 1 to Clear: These bits can be read and cleared by software. Reading a bit will set the bit to '1'. Writing a '1' to a bit will clear it, while writing a '0' to a bit has no effect.
RCW	Read Clear / Write: These bits can be read and written by software, but a read causes the bits to be cleared. NOTE: Use of this attribute type is only allowed on legacy functions, as side-effects on reads are not desirable.

Table 11-2 lists the modifiers used in conjunction with attributes that are included in the register tables throughout this document.



Table 11-2. Register Terminology Attribute Modifier

Attribute Modifier	Applicable Attribute	Description
S	RO (with -V)	Sticky: These bits are only re-initialized to their default value by a Power Good Reset. Note: Does not apply to RO (constant) bits.
	RW	
	RW1C	
	RW1S	
-K	RW	Key: These bits control the ability to write other bits (identified with a Lock modifier).
-L	RW	Lock: Hardware can make these bits Read-Only via a separate configuration bit or other logic. Note: Mutually exclusive with Once modifier.
	WO	
-O	RW	Once: After reset, these bits can only be rewritten by software once after which they become Read Only. Note: Mutually exclusive with Variant modifier
	WO	
-FW	RO	Firmware Write: The value of these bits can be updated by firmware (PCU, TAR, etc.).
-V	RO	Variant: The value of these bits can be updated by hardware. Note: RW1C and RC are variant by definition and therefore do not need to be modified.

11.1 ERRSTS - Error Status

B/D/F/Type: 0/0/0/PCI
 Address Offset: C8-C9h
 Default Value: 0000h
 Access: RO; RW1C-S
 Size: 16 bits
 BIOS Optimal Default 0000h

This register is used to report various error conditions via the SERR DMI messaging mechanism. The SERR DMI message is generated on a zero to one transition of any of these flags (if enabled by the ERRCMD and PCICMD registers).

These bits are set regardless of whether or not the SERR is enabled and generated. After the error processing is complete, the error logging mechanism can be unlocked by clearing the appropriate status bit by software writing a '1' to it.

Table 11-3. Error Status Register (Sheet 1 of 2)

Bit	Access	Default Value	RST/PWR	Description
15:2	RO	0h		Reserved (RSVD)



Table 11-3. Error Status Register (Sheet 2 of 2)

Bit	Access	Default Value	RST/ PWR	Description
1	RW1C-S	0b	Powergood	Multiple-bit DRAM ECC Error Flag (DMERR): If this bit is set to 1, a memory read data transfer had an uncorrectable multiple-bit error. When this bit is set, the column, row, bank, and rank that caused the error, and the error syndrome, are logged in the ECC Error Log register in the channel where the error occurred. Once this bit is set, the ECCERRLOGx fields are locked until the processor clears this bit by writing a 1. Software uses bits [1:0] to detect whether the logged error address is for a Single-bit or a Multiple-bit error. This bit is reset on PWROK.
0	RW1C-S	0b	Powergood	Single-bit DRAM ECC Error Flag (DSERR): If this bit is set to 1, a memory read data transfer had a single-bit correctable error and the corrected data was returned to the requesting agent. When this bit is set the column, row, bank, and rank where the error occurred and the syndrome of the error are logged in the ECC Error Log register in the channel where the error occurred. Once this bit is set the ECCERRLOGx fields are locked to further single-bit error updates until the CPU clears this bit by writing a 1. A multiple bit error that occurs after this bit is set will overwrite the ECCERRLOGx fields with the multiple-bit error signature and the DMERR bit will also be set. A single bit error that occurs after a multibit error will set this bit but will not overwrite the other fields. This bit is reset on PWROK.

11.2 ERRCMD - Error Command

B/D/F/Type:	0/0/0/PCI
Address Offset:	CA-CBh
Default Value:	0000h
Access:	RO; RW
Size:	16 bits
BIOS Optimal Default	0000h

This register controls the Host Bridge responses to various system errors. Since the Host Bridge does not have an SERRB signal, SERR messages are passed from the Processor to the PCH over DMI.

When a bit in this register is set, a SERR message will be generated on DMI whenever the corresponding flag is set in the ERRSTS register. The actual generation of the SERR message is globally enabled for Device 0 via the PCI Command register.



Table 11-4. Error Command Registers

Bit	Access	Default Value	RST/ PWR	Description
15:2	RO	0h		Reserved (RSVD)
1	RW	0b	Uncore	SERR Multiple-Bit DRAM ECC Error (DMERR): 1 = The Host Bridge generates an SERR message over DMI when it detects a multiple-bit error reported by the DRAM controller. 0 = Reporting of this condition via SERR messaging is disabled. For systems not supporting ECC, this bit must be disabled.
0	RW	0b	Uncore	SERR on Single-bit ECC Error (DSERR): 1 = The Host Bridge generates an SERR special cycle over DMI when the DRAM controller detects a single bit error. 0 = Reporting of this condition via SERR messaging is disabled. For systems that do not support ECC, this bit must be disabled.

11.3 SMICMD - SMI Command

B/D/F/Type: 0/0/0/PCI
 Address Offset: CC-CDh
 Default Value: 0000h
 Access: RO; RW
 Size: 16 bits
 BIOS Optimal Default 0000h

This register enables various errors to generate an SMI DMI special cycle. When an error flag is set in the ERRSTS register, it can generate an SERR, SMI, or SCI DMI special cycle when enabled in the ERRCMD, SMICMD, or SCICMD registers respectively. One and only one message type can be enabled.

Table 11-5. SMI Command Registers

Bit	Access	Default Value	RST/ PWR	Description
15:2	RO	0h		Reserved (RSVD)
1	RW	0b	Uncore	SMI on Multiple-Bit DRAM ECC Error (DMESMI): 1 = The Host generates an SMI DMI message when it detects a multiple-bit error reported by the DRAM controller. 0 = Reporting of this condition via SMI messaging is disabled. For systems not supporting ECC, this bit must be disabled.
0	RW	0b	Uncore	SMI on Single-bit ECC Error (DSESMI): 1 = The Host generates an SMI DMI special cycle when the DRAM controller detects a single bit error. 0 = Reporting of this condition via SMI messaging is disabled. For systems that do not support ECC, this bit must be disabled.



11.4 SCICMD - SCI Command

B/D/F/Type:	0/0/0/PCI
Address Offset:	CE-CFh
Default Value:	0000h
Access:	RO; RW
Size:	16 bits
BIOS Optimal Default	0000h

This register enables various errors to generate an SCI DMI special cycle. When an error flag is set in the ERRSTS register, it can generate an SERR, SMI, or SCI DMI special cycle when enabled in the ERRCMD, SMICMD, or SCICMD registers respectively. One and only one message type can be enabled.

Table 11-6. SCI Command Registers

Bit	Access	Default Value	RST/ PWR	Description
15:2	RO	0h		Reserved (RSVD)
1	RW	0b	Uncore	SCI on Multiple-Bit DRAM ECC Error (DMESMI): 1 = The Host generates an SCI DMI message when it detects a multiple-bit error reported by the DRAM controller. 0 = Reporting of this condition via SCI messaging is disabled. For systems not supporting ECC, this bit must be disabled.
0	RW	0b	Uncore	SCI on Single-bit ECC Error (DSESMI): 1 = The Host generates an SCI DMI special cycle when the DRAM controller detects a single bit error. 0 = Reporting of this condition via SCI messaging is disabled. For systems that do not support ECC, this bit must be disabled.

11.5 ECCERRLOGO_C0 - ECC Error Log 0

B/D/F/Type:	0/0/0/MCHBAR MCO
Address Offset:	40C8-40CBh
Default Value:	00000000h
Access:	ROS-V
Size:	32 bits
BIOS Optimal Default	0000h

This Channel 0 register is used to store the error status information in ECC enabled configurations, along with the error syndrome and the rank and bank address information of the address block of main memory of which an error (single bit or multi-bit error) has occurred. The address fields represent the address of the first single or the first multiple bit error occurrence after the error flag bits in the ERRSTS register have been cleared by software. A multiple bit error will overwrite a single bit error.



Once the error flag bits are set as a result of an error, this bit field is locked and doesn't change as a result of a new error until the error flag is cleared by software. Same is the case with error syndrome field.

Table 11-7. Channel 0 ECC Error Log 0

Bit	Access	Default Value	RST/PWR	Description
31:29	ROS-V	000b	Powergood	Error Bank Address (ERRBANK): This field holds the Bank Address of the read transaction that had the ECC error.
28:27	ROS-V	00b	Powergood	Error Rank Address (ERRRANK): This field holds the Rank ID of the read transaction that had the ECC error.
26:24	ROS-V	000b	Powergood	Error Chunk (ERRCHUNK): Holds the chunk number of the error stored in the register.
23:16	ROS-V	00h	Powergood	Error Syndrome (ERRSYND): This field contains the error syndrome. A value of FFh indicates that the error is due to poisoning. Note: For ERRSYND definition see Table 11-13, "Error Syndrome - ERRSYND"
15:2	RO	0h		Reserved (RSVD)
1	ROS-V	0b	Powergood	Multiple Bit Error Status (MERRSTS): This bit is set when an uncorrectable multiple-bit error occurs on a memory read data transfer. When this bit is set, the address that caused the error and the error syndrome are also logged and they are locked until this bit is cleared. This bit is cleared when the corresponding bit in 0.0.0.PCI.ERRSTS is cleared.
0	ROS-V	0b	Powergood	Correctable Error Status (CERRSTS): This bit is set when a correctable single-bit error occurs on a memory read data transfer. When this bit is set, the address that caused the error and the error syndrome are also logged and they are locked to further single bit errors, until this bit is cleared. A multiple bit error that occurs after this bit is set will override the address/error syndrome information. This bit is cleared when the corresponding bit in 0.0.0.PCI.ERRSTS is cleared.

11.6 ECCERRLOG1_C0 - ECC Error Log 1

B/D/F/Type: 0/0/0/MCHBAR MCO
 Address Offset: 40CC-40CFh
 Default Value: 00000000h
 Access: ROS-V
 Size: 32 bits

This register is used to store the error status information in ECC enabled configurations, along with the error syndrome and the row and column address information of the address block of main memory of which an error (single bit or multi-bit error) has occurred.



Table 11-8. Channel 0 ECC Error Log 1

Bit	Access	Default Value	RST/ PWR	Description
31:16	ROS-V	0000h	Powergood	Error Column (ERRCOL): This field holds the DRAM column address of the read transaction that had the ECC error.
15:0	ROS-V	0000h	Powergood	Error Row (ERRROW): This field holds the DRAM row (page) address of the read transaction that had the ECC error.

11.7 ECCERRLOGO_C1 - ECC Error Log 0

B/D/F/Type:	0/0/0/MCHBAR MC1
Address Offset:	44C8-44CBh
Default Value:	00000000h
Access:	ROS-V
Size:	32 bits
BIOS Optimal Default	0000h

This Channel 1 register is used to store the error status information in ECC enabled configurations, along with the error syndrome and the rank and bank address information of the address block of main memory of which an error (single bit or multi-bit error) has occurred. The address fields represent the address of the first single or the first multiple bit error occurrence after the error flag bits in the ERRSTS register have been cleared by software. A multiple bit error will overwrite a single bit error. Once the error flag bits are set as a result of an error, this bit field is locked and doesn't change as a result of a new error until the error flag is cleared by software. Same is the case with error syndrome field.

Table 11-9. Channel 1 ECC Error Log 0 (Sheet 1 of 2)

Bit	Access	Default Value	RST/ PWR	Description
31:29	ROS-V	000b	Powergood	Error Bank Address (ERRBANK): This field holds the Bank Address of the read transaction that had the ECC error.
28:27	ROS-V	00b	Powergood	Error Rank Address (ERRRANK): This field holds the Rank ID of the read transaction that had the ECC error.
26:24	ROS-V	000b	Powergood	Error Chunk (ERRCHUNK): Holds the chunk number of the error stored in the register.
23:16	ROS-V	00h	Powergood	Error Syndrome (ERRSYND): This field contains the error syndrome. A value of FFh indicates that the error is due to poisoning. For ERRSYND definition see Table 11-13, "Error Syndrome - ERRSYND"
15:2	RO	0h		Reserved (RSVD)



Table 11-9. Channel 1 ECC Error Log 0 (Sheet 2 of 2)

Bit	Access	Default Value	RST/ PWR	Description
1	RO-P	0b	Powergood	Multiple Bit Error Status (MERRSTS): This bit is set when an uncorrectable multiple-bit error occurs on a memory read data transfer. When this bit is set, the address that caused the error and the error syndrome are also logged and they are locked until this bit is cleared. This bit is cleared when the corresponding bit in 0.0.0.PCI.ERRSTS is cleared.
0	RO-P	0b	Powergood	Correctable Error Status (CERRSTS): This bit is set when a correctable single-bit error occurs on a memory read data transfer. When this bit is set, the address that caused the error and the error syndrome are also logged and they are locked to further single bit errors, until this bit is cleared. A multiple bit error that occurs after this bit is set will override the address/error syndrome information. This bit is cleared when the corresponding bit in 0.0.0.PCI.ERRSTS is cleared.

11.8 ECCERRLOG1_C1 - ECC Error Log 1

B/D/F/Type: 0/0/0/MCHBAR MC1
 Address Offset: 44CC-44CFh
 Default Value: 00000000h
 Access: ROS-V
 Size: 32 bits

This register is used to store the error status information in ECC enabled configurations, along with the error syndrome and the row and column address information of the address block of main memory of which an error (single bit or multi-bit error) has occurred.

Table 11-10. Channel 1 ECC Error Log 1

Bit	Access	Default Value	RST/ PWR	Description
31:16	ROS-V	0000h	Powergood	Error Column (ERRCOL): This field holds the DRAM column address of the read transaction that had the ECC error.
15:0	ROS-V	0000h	Powergood	Error Row (ERRROW): This field holds the DRAM row (page) address of the read transaction that had the ECC error.

11.9 MAD_DIMM_CHO - Address Decode Channel 0

B/D/F/Type: 0/0/0/MCHBAR_MCMAIN
 Address Offset: 5004-5007h
 Default Value: 00600000h
 Access: RW-L



Size: 32 bits

BIOS Optimal Default 00h

This register defines channel characteristics - number of DIMMs, number of ranks, size, ECC, interleave options and ECC options.

Table 11-11. Address Decode Channel 0

Bit	Access	Default Value	RST/ PWR	Description
31:26	RO	0h		Reserved (RSVD)
25:24	RW-L	00b	Uncore	ECC is active in the channel (ECC): 00 = no ECC active in the channel 01 = ECC is active in IO, ECC logic is not active In this case, on write accesses the data driven on ECC byte is copied from DQ 7:0 (to be used in training or IOSAV) 10 = ECC is disabled in IO, but ECC logic is enabled (to be used in ECC4ANA mode) 11 = ECC active in both IO and ECC logic
23:23	RO	0h		Reserved (RSVD)
22	RW-L	1b	Uncore	Enhanced Interleave mode (Enh_Interleave): 0 = off 1 = on
21	RW-L	1b	Uncore	Rank Interleave (RI): Rank Interleave 0 = off 1 = on
20	RW-L	0b	Uncore	DIMM B DDR width (DBW): DIMM B width of DDR chips 0 = X8 chips 1 = X16 chips
19	RW-L	0b	Uncore	DIMM A DDR width (DAW): DIMM A width of DDR chips 0 = X8 chips 1 = X16 chips
18	RW-L	0b	Uncore	DIMM B number of ranks (DBNOR): 0 = single rank 1 = dual rank
17	RW-L	0b	Uncore	DIMM A number of ranks (DANOR): 0 = single rank 1 = dual rank
16	RW-L	0b	Uncore	DIMM A select (DAS): Selects which of the DIMMs is DIMM A - should be the larger DIMM: 0 - DIMM 0 1 - DIMM 1
15:8	RW-L	00h	Uncore	Size of DIMM B (DIMM_B_Size): Size of DIMM B 256 MB multiples
7:0	RW-L	00h	Uncore	Size of DIMM A (DIMM_A_Size): Size of DIMM A 256 MB multiples



11.10 MAD_DIMM_CH1 - Address Decode Channel 1

B/D/F/Type: 0/0/0/MCHBAR_MCMAIN
 Address Offset: 5008-500Bh
 Default Value: 00600000h
 Access: RW-L
 Size: 32 bits
 BIOS Optimal Default 00h

This register defines channel characteristics - number of DIMMs, number of ranks, size, ECC, interleave options and ECC options.

Table 11-12. Address Decode Channel 1 (Sheet 1 of 2)

Bit	Access	Default Value	RST/PWR	Description
31:26	RO	0h		Reserved (RSVD)
25:24	RW-L	00b	Uncore	ECC is active in the channel (ECC): 00 =no ECC active in the channel 01 =ECC is active in IO, ECC logic is not active In this case, on write accesses the data driven on ECC byte is copied from DQ 7:0 (to be used in training or IOSAV) 10 =ECC is disabled in IO, but ECC logic is enabled (to be used in ECC4ANA mode) 11 =ECC active in both IO and ECC logic
23:23	RO	0h		Reserved (RSVD)
22	RW-L	1b	Uncore	Enhanced Interleave mode (Enh_Interleave): 0 = off 1 = on
21	RW-L	1b	Uncore	Rank Interleave (RI): 0 = off 1 = on
20	RW-L	00b	Uncore	DIMM B DDR width (DBW): DBW: DIMM B width of DDR chips 0 = X8 chips 1 = X16 chips
19	RW-L	00b	Uncore	DIMM A DDR width (DAW): DAW: DIMM A width of DDR chips 0 = X8 chips 1 = X16 chips
18	RW-L	0b	Uncore	DIMM B number of ranks (DBNOR): 0 = single rank 1 = dual rank



Table 11-12. Address Decode Channel 1 (Sheet 2 of 2)

Bit	Access	Default Value	RST/ PWR	Description
17	RW-L	0b	Uncore	DIMM A number of ranks (DANOR): 0 = single rank 1 = dual rank
16	RW-L	0b	Uncore	DIMM A select (DAS): Selects which of the DIMMs is DIMM A - should be the larger DIMM: 0 = DIMM 0 1 = DIMM 1
15:8	RW-L	00h	Uncore	Size of DIMM B (DIMM_B_Size): Size of DIMM B 256 MB multiples
7:0	RW-L	00h	Uncore	Size of DIMM A (DIMM_A_Size): Size of DIMM A 256 MB multiples

Note: This document supplements or overrides the *2nd Generation Intel® Core™ Processor Family Mobile Datasheet – Volume 1*. For all information not contained in this document, see the latest version of the *2nd Generation Intel® Core™ Processor Family Mobile Datasheet – Volume 2*.

11.11 Error Detection and Correction

If ECC is enabled and DIMMS with ECC are used, through an Error Correction Code algorithm the memory controller is able to detect and correct single bit errors or detect multiple bit errors. ECC increases the reliability of the DRAM devices by allowing single bit errors to be fixed and detecting multi-bit errors but it requires additional bits to store the error correction code. The ECC algorithm requires an 8-bit error correction code. DIMMs with ECC are 72 bits wide, the first 64 bits are for data and the last 8 bits are for the Check Bits.

Detection of correctable or uncorrectable errors are reported in the “[ERRSTS - Error Status](#)” register. When either Single-bit correctable or Multi-bit uncorrectable errors are detected, the column, row, bank, and rank that caused the error, and the error syndrome, are logged in the ECC Error Log registers in the channel where the error occurred. Channel 0 and Channel 1 errors are detailed in [Section 11.5](#), “[ECCERRLOG0_C0 - ECC Error Log 0](#)”, [Section 11.6](#), “[ECCERRLOG1_C0 - ECC Error Log 1](#)”, [Section 11.7](#), “[ECCERRLOG0_C1 - ECC Error Log 0](#)” and [Section 11.8](#), “[ECCERRLOG1_C1 - ECC Error Log 1](#)” respectively. If an uncorrectable error occurs after a correctable error, then the address and syndrome information will be replaced with the uncorrectable error information.

During the write cycle, ECC check bits are generated 1 per 8 bits of data by XORing a particular combination of the written bits with an associated Check Bit. The result of this function creates a syndrome byte that is visible via “[Error Syndrome \(ERRSYND\)](#)”, (“[ECCERRLOG0_C0 - ECC Error Log 0](#)” or “[ECCERRLOG0_C1 - ECC Error Log 0](#)”).

Table 11-13 provides a lookup of the ERRSYND and defines the failing data bit.

Table 11-13. Error Syndrome - ERRSYND (Sheet 1 of 3)

Syndrome (ERRSYND)	Bit Locator	DQ/CB Locator
0x00	No Error	
0x01	64	CB0



Table 11-13. Error Syndrome - ERRSYND (Sheet 2 of 3)

Syndrome (ERRSYND)	Bit Locator	DQ/CB Locator
0x02	65	CB1
0x04	66	CB2
0x07	60	DQ60
0x08	67	CB3
0x0B	36	DQ36
0x0D	27	DQ27
0x0E	3	DQ3
0x10	68	CB4
0x13	55	DQ55
0x15	10	DQ10
0x16	29	DQ29
0x19	45	DQ45
0x1A	57	DQ57
0x1C	0	DQ0
0x1F	15	DQ15
0x20	69	CB5
0x23	39	DQ39
0x25	26	DQ26
0x26	46	DQ46
0x29	61	DQ61
0x2A	9	DQ9
0x2C	16	DQ16
0x2F	23	DQ23
0x31	63	DQ63
0x32	47	DQ47
0x34	14	DQ14
0x38	30	DQ30
0x40	70	CB6
0x43	6	DQ6
0x45	42	DQ42
0x46	62	DQ62
0x49	12	DQ12
0x4A	25	DQ25
0x4C	32	DQ32
0x4F	51	DQ51
0x51	2	DQ2
0x52	18	DQ18
0x54	34	DQ34
0x58	50	DQ50
0x61	21	DQ21



Table 11-13. Error Syndrome - ERRSYND (Sheet 3 of 3)

Syndrome (ERRSYND)	Bit Locator	DQ/CB Locator
0x62	38	DQ38
0x64	54	DQ54
0x68	5	DQ5
0x70	52	DQ52
0x80	71	CB7
0x83	22	DQ22
0x85	58	DQ58
0x86	13	DQ13
0x89	28	DQ28
0x8A	41	DQ41
0x8C	48	DQ48
0x8F	43	DQ43
0x91	37	DQ37
0x92	53	DQ53
0x94	4	DQ4
0x98	20	DQ20
0xA1	49	DQ49
0xA2	1	DQ1
0xA4	17	DQ17
0xA8	33	DQ33
0xB0	44	DQ44
0xC1	8	DQ8
0xC2	24	DQ24
0xC4	40	DQ40
0xC8	56	DQ56
0xD0	19	DQ19
0xE0	11	DQ11
0xF1	7	DQ7
0xF2	31	DQ31
0xF4	59	DQ59
0xF8	35	DQ35
0xFF	Error reported is due to poisoning	
All Other Values	Unrecoverable Multi-bit errors	

§ §



X-ON Electronics

Largest Supplier of Electrical and Electronic Components

Click to view similar products for CPU - Central Processing Units category:

Click to view products by Intel manufacturer:

Other Similar products are found below :

[D8751H](#) [AT80612003090AAS LBWJ](#) [N87C51](#) [IVPX7225-RTM-1](#) [CM8063401286600S R1AK](#) [CM8063501374802S R1A5](#)
[CM8063501375101S R1A8](#) [MATXM-CORE-411-HTSNK](#) [BGSF 1717MN26 E6327](#) [BX80621E52620 S R0KW](#) [IVPX7225-02250813L](#)
[D8086-2](#) [CM8063401293902S R1A4](#) [CM8063501374901S R1A6](#) [CM8066201928505 SR2HT](#) [CM8063501293200S R1A0](#)
[CM8062301046008S R060](#) [ATLASEDGE.1](#) [AV8063801129600S R10F](#) [R0K5ML001SS00BR](#) [CM8066201921712S R2LF](#)
[CM8064601467102S R152](#) [CM8063701094000S R0TA](#) [CM8063501375800S R1AX](#) [CM8063401376400S R1A9](#) [CM8063401293802S R1A3](#)
[CM8063401286102S R19S](#) [CM8062107185405S R0KM](#) [CM8066002032201S R2R6](#) [CM8063501288301S R1AN](#) [COMX-300-HSP](#) [RTM-](#)
[ATCA-7360](#) [96MPI7-3.4-8M11T](#) [96MPP-2.3-3M10T](#) [96MPI7-3.4-8M11T1](#) [96MPXE-2.0-15M20T](#) [96MPI5-3.0-6M10T](#) [96MPI5S-2.3-](#)
[6M11T1](#) [FJ8066401715827S R2KG](#) [AFPC205 S R1Z1](#) [DNCE2510 S LHCM](#) [FJ8066401715843S R2KH](#) [DNCE2530G S LHCY](#)
[DNCE2510GU S LHCW](#) [CM8066201935807S R2LM](#) [FH8065503554000S R3H4](#) [FH8065301615104S R1UU](#) [CM8066201934909S R2LK](#)
[FJ8067702739633S R340](#) [CM8068403360212 SR3XB](#)