



Intel® Server Board S2600WT Family

Intel® Server Chassis R1000WT & R2000WT Family

Intel® Server System R1000WT & R2000WT Family

Intel® Storage System R1000WT Family

Product Family Configuration Guide

A Reference document used to assist with ordering parts and accessories available to configure an Intel server system based on the Intel® Server S2600WT product family.

Revision 2.16
April 23, 2019

Intel® Server Products and Solutions

<Blank Page>

Document Revision History

Date Published	Revision	Revision Change Description
September 2014	1.0	First Public Release
November 2014	1.16	Updates to product illustrations and MM# for Intel® RAID Modules
March 2015	1.17	Content updates: <ul style="list-style-type: none"> • DC Power Supply option target availability date • New Rail kit options target availability date • Removed I/O Module AXX10GBTWLIOM – Not supported • Added I/O Module AXX10GBTWLIOM3 with target availability date
April 2015	2.0	Document Upgrade <ul style="list-style-type: none"> • New document format • New product definition/data tables • New graphics • Improved guidance for configuration requirements • Improved descriptions for product family definition • Updated SAS/SATA data cable guide • Updated Disclaimer Statements
May 2015	2.01	Document changes: <ul style="list-style-type: none"> • Added “Server” reference to product family naming • Corrected 1U riser part number in 1U L6 BOM Lists • Updated Server Board, Chassis only and L6 product weight information
July 2015	2.02	Document Upgrade <ul style="list-style-type: none"> • Updated AXX750DCCRPS target availability date • Updated A1USHRTRAIL Order Information • Updated A1UFULLRAIL Order Information • Updated AXXFULLRAIL Order Information • Updated AXXCMA2 Order Information
August 2015	2.03	Document changes <ul style="list-style-type: none"> • Added Intel® Integrated RAID Module RMS25CB080
September 2015	2.04	Document changes <ul style="list-style-type: none"> • Added McAfee® Antivirus as an accessory
November 2015	2.05	Document changes <ul style="list-style-type: none"> • Removed the Ethernet modules AXX1P40FRTIOM and AXX2P40FRTIOM that are based on XL710-AM2.
November 2015	2.06	Document changes <ul style="list-style-type: none"> • Server Board and L6 System Product Codes updated with “R”. Order information Updated MM#, UPC, EAM.

Intel® Server S2600WT Product Family Configuration Guide and Spares/Accessories List

Date Published	Revision	Revision Change Description
February 2016	2.07	Document changes <ul style="list-style-type: none"> • Added Intel Storage System R1000WT Family to the document • Added 2u Short Rail Kit option to document • Updated order information for McAfee Antivirus Software • Fixed several section reference links throughout the document • Added references showing support for Intel® Xeon® processor E5-2600 v4 on all server boards and systems • Added Intel TPM AXXTPE6 and AXXTPE7 • Added new board SKU S2600WTTS1R
March 2016	2.07	Document changes <ul style="list-style-type: none"> • Added new Intel® PCI Express 8-Lane, 4-Port Fan-Out Switch “AXX4PX8HDAIC”
June 2016	2.08	Document changes <ul style="list-style-type: none"> • Added new Intel® Omni-Path Host Fabric Interface Adapter 100 Series 1 “100HFA016LS” • Added new Intel® Integrated RAID Module “RMS3AC160”
July 2016	2.09	Document changes <ul style="list-style-type: none"> • Removed from document the SKUs R1208WTTA04NVMR and R1208WTTB04NVMR • Added new 1U riser 3 PCIe* retimer “A1U2PXR3HDAIC” • Added the Ethernet modules AXX1P40FRTIOM and AXX2P40FRTIOM. • Added Remote Management Module 4 version 2 (RoHS free) – AXXRMM4LITE2 • Removed Intel® Integrated RAID Module “RMS3AC160” • Added Intel® Integrated RAID Module RMS3VC160 • Fixed travel length of Rail spares “AXXFULLRAIL” and “AXXSHRTRAIL” • Rewording note in SKUs “R2312WTTYSR” and “R2224WTTYSR”
October	2.10	Document Changes <ul style="list-style-type: none"> • Removed line in chapter 5.3 of the “Intel® Accessory Kit A2U44X25NVMEDK2”.
November	2.11	Document Changes <ul style="list-style-type: none"> • Added data of bracket adjustment for RAILS
April	2.12	Document Changes <ul style="list-style-type: none"> • Processors Family supported • Replaced the FR1304S3HSBP Spare with FR1304S3HSBP2 (RoHs free). • Added Visual Compute Accelerator, VCA1283LVV • Replaced image of spare “A2UL16RISER2” with correct one.
July	2.13	Document Changes <ul style="list-style-type: none"> • Added air duct “AWTCOPRODUCT” as a required accessory for the visual computing accelerator • Added back Intel® Integrated RAID Module “RMS3AC160” (Issue fixed) • Added RAID Maintenance Free Backup Unit AXXRFMBU6
April	2.14	Document Changes <ul style="list-style-type: none"> • Added Visual Compute Accelerator, VCA1585LMV

Intel® Server S2600WT Product Family Configuration Guide and Spares/Accessories List

Date Published	Revision	Revision Change Description
September 2018	2.15	Document Changes <ul style="list-style-type: none">• Replaced spare “FXXFPANEL” with “FXXFPANEL2”• Updated links of “Additional information for Intel RAID products”
April 2019	2.16	Document Changes <ul style="list-style-type: none">• Added details of supported lengths in systems 1U when RAID modules are installed

Disclaimer

Intel technologies' features and benefits depend on system configuration and may require enabled hardware, software or service activation. Learn more at Intel.com, or from the OEM or retailer.

You may not use or facilitate the use of this document in connection with any infringement or other legal analysis concerning Intel products described herein. You agree to grant Intel a non-exclusive, royalty-free license to any patent claim thereafter drafted which includes subject matter disclosed herein.

No license (express or implied, by estoppel or otherwise) to any intellectual property rights is granted by this document.

The products described may contain design defects or errors known as errata which may cause the product to deviate from published specifications. Current characterized errata are available on request.

Intel disclaims all express and implied warranties, including without limitation, the implied warranties of merchantability, fitness for a particular purpose, and non-infringement, as well as any warranty arising from course of performance, course of dealing, or usage in trade.

Intel, the Intel logo, Xeon, and Xeon Phi, McAfee are trademarks of Intel Corporation in the U.S. and/or other countries.

*Other names and brands may be claimed as the property of others.

Copyright © 2018 Intel Corporation. All Rights Reserved.

Table of Contents

1	Intel Server Family Overview.....	1
1.1	<i>Intel® S2600WT Server Chassis and Server System Product Code Naming Convention.....</i>	<i>3</i>
1.2	<i>Product Family Summary Chart.....</i>	<i>6</i>
1.3	<i>Intel® S2600GZ/GL Product Family to Intel® Server S2600WT Product Family Transition Guide.....</i>	<i>1</i>
1.4	<i>Intel® supported Xeon® Processors E5-2600 v3, v4, Family.....</i>	<i>2</i>
2	Server Building Block Configuration.....	2
2.1	<i>Building Block Recipe Summary.....</i>	<i>3</i>
2.2	<i>Intel® Server Board S2600WT Product Family SKUs.....</i>	<i>4</i>
	iPC – S2600WT2R.....	4
	iPC – S2600WTTR.....	5
	iPC – S2600WTTS1R.....	6
2.3	<i>Intel® Server Chassis R1000WT Product Family SKUs – (1U Rack Mount Chassis).....</i>	<i>7</i>
2.4	<i>Intel® Server Chassis R2000WT Product Family SKUs – (2U Rack Mount Chassis).....</i>	<i>10</i>
3	Server System Configuration.....	14
3.1	<i>Intel® Server/Storage System R1000WT Product Family SKUs – (1U Rack Mount System).....</i>	<i>15</i>
3.2	<i>Intel® Server System R2000WT Product Family SKUs – (2U Rack Mount System).....</i>	<i>20</i>
4	SAS / SATA Data Cable Guide.....	27
4.1	<i>SAS / SATA Data Cable Connector Types.....</i>	<i>27</i>
4.2	<i>1U / 2U Server System SAS / SATA Cable Guide.....</i>	<i>28</i>
4.2.1	1U 4 x 3.5" – R1304WTxxx SAS / SATA Data Cable Guide.....	30
4.2.2	1U 8 x 2.5" – R1208WTxxx SAS / SATA Data Cable Guide.....	31
4.2.3	2U 8 x 3.5" – R2308WTxxx Cable Guide.....	32
4.2.4	2U 12 x 3.5" – R2312WTxxx Cable Guide.....	33
4.2.5	2U 2.5" Front Mount Drive Bay Cable Guide.....	38
4.3	<i>Intel SAS / SATA Data Cable Kits.....</i>	<i>45</i>
5	Intel 1U / 2U System Configuration Options.....	49

5.1	1U 8x2.5" Combo PCIe* SFF (NVMe) SSD / SAS Backplane – Intel® Accessory Kit A1U44X25NVMEDK	49
5.1.1	1U 8x2.5" – Intel® Accessory Kit A1U44X25NVMEDK Cable Guide	50
5.2	2U 8x2.5" Combo PCIe* SFF (NVMe) SSD / SAS Backplane – Intel® Accessory Kit A2U44X25NVMEDK	52
5.2.1	2U 8x2.5" – Intel® Accessory Kit A2U44X25NVMEDK SAS/SATA Cable Guide	54
5.2.2	2U 16x2.5" / 24x2.5" — Intel® Accessory Kit A2U44X25NVMEDK SAS / SATA Cable Guide	55
5.3	2U 8x2.5" Combo PCIe x8 SFF (NVMe) SSD / SAS Backplane – Intel® Accessory Kit A2U44X25NVMEDK2	56
5.3.1	2U Chassis Drive Bay Identification	58
5.4	2U Rear Mount Hot Swap Drive Bay Accessory Kit – iPC A2UREARHSDK	59
	iPC - A2UCBLSSD	60
5.5	2U 8x3.5" Front Mount Hot Swap Backplane Assembly - iPC A2U8X35S3HSDK.....	61
	iPC – A2U8X35S3HSDK	61
5.6	2U 8x2.5" Drive Bay Module Options.....	62
	iPC – A2U8X25S3HSDK.....	63
	iPC – A2U8X25S3DPDK.....	63
	iPC – A2UHANDLKIT.....	64
5.7	Locking Front Bezel Accessory Kits	65
5.7.1	2U Front Bezel Accessory Kit – iPC A2UBEZEL.....	65
5.7.2	1U Front Bezel Accessory Kit – iPC A1UBEZEL.....	66
5.8	1U / 2U PCIe* Riser Card Accessory/Spare FRU Options	67
5.8.1	1U Riser Card Options	67
5.8.2	2U Riser Card Options	68
5.9	Intel® I/O Expansion Modules	69
5.10	Intel® SAS RAID Add-in Cards, Modules, and Accessories.....	72
5.10.1	Intel® Integrated RAID Module RMS3 Product Family – SAS 3.0 (12 Gb/s).....	73
5.10.2	Intel® RAID Accessory Options	79
5.11	Intel® PCI Express NVMe Add-in Cards	81
5.12	Intel Power Supply Modules and Power Cords	82
5.13	1U / 2U Rack Mount Kits	83
5.13.1	iPC - AXXPRAIL.....	83
5.13.2	iPC – AXXELVRAIL	83
5.13.3	iPC – AXX1U2UCMA.....	83
	iPC - AXX2POSTBRCKT	84

5.13.4	Intel® Xeon Phi™ Coprocessor Card and Non-Intel GPGPU Support.....	85
	iPC – AWT COPRODUCT	87
	iPC – A2UL16RISER2	87
5.14	Intel® I/O Expansion Add-in Cards.....	88
	iPC – 100HFA016LS.....	88
6	1U / 2U Miscellaneous Accessory Options	89
	iPC – A1U2ULCP.....	89
	iPC – AXXSATADVDR0M.....	89
	iPC – AXXSATADVDRWROM	89
	iPC - AXXSSDODDKIT	90
	iPC - AXXRJ45DB93	90
	iPC - AXXRMM4LITE.....	90
	iPC - AXXRMM4LITE2	91
	iPC - AXXT PME5	91
	iPC – AXXT PME6.....	91
	iPC – AXXT PME7	92
7	1U / 2U Spare and Replacement Parts (FRUs).....	93
8	Intel® Visual Compute Accelerators.....	96
9	Software Security - McAfee® Antivirus for Intel® Server Systems*	98
9.1	<i>How to order it?</i>	98
9.2	<i>McAfee® Antivirus for Intel® Server Systems</i>	98
10	Extended Warranty	100
	Glossary of Terms	101

List of Tables

Table 1. Product Family Reference Collaterals	2
Table 2. Server Board Product Family Summary.....	6
Table 3. Server Chassis & Server/Storage System Product Family Summary	6
Table 4. 1U / 2U Server System Product Family Generation to Generation Transition Guide	1
Table 5. 1U / 2U Building Block to Integrated System Recipe Guide	3
Table 6. 2U 12 x 3.5" – R2312WTxxx SAS / SATA Data Cable Guide (with SAS Expander).....	35
Table 7. 2U 8 x 2.5" (Drive Bay #1) - SAS/SATA Data Cable Guid (with no SAS Expander)	39
Table 8. 2U 8 x 2.5" (Drive Bay #2) – SAS / SATA Data Cable Guide (with no SAS Expander).....	40
Table 9. 2U 8 x 2.5" (Drive Bay #3) – SAS / SATA Data Cable Guide (with no SAS Expander).....	41
Table 10. 2U 2.5" Front Mount Drive Configurations with SAS Expander – SAS Data Cable Guide	43
Table 11. Storage Data Cable Kit Description and Order Information.....	46
Table 12. 1U 8x2.5" Combo Backplane SAS/SATA Cable Guide	51

1 Intel Server Family Overview

This document is provided to assist Intel customers with identifying the right Intel server system and available accessories to create a unique server platform that meet their unique server requirements.

The Intel® S2600WT product family is offered as both building block options and integrated systems. The product family consists of the following:

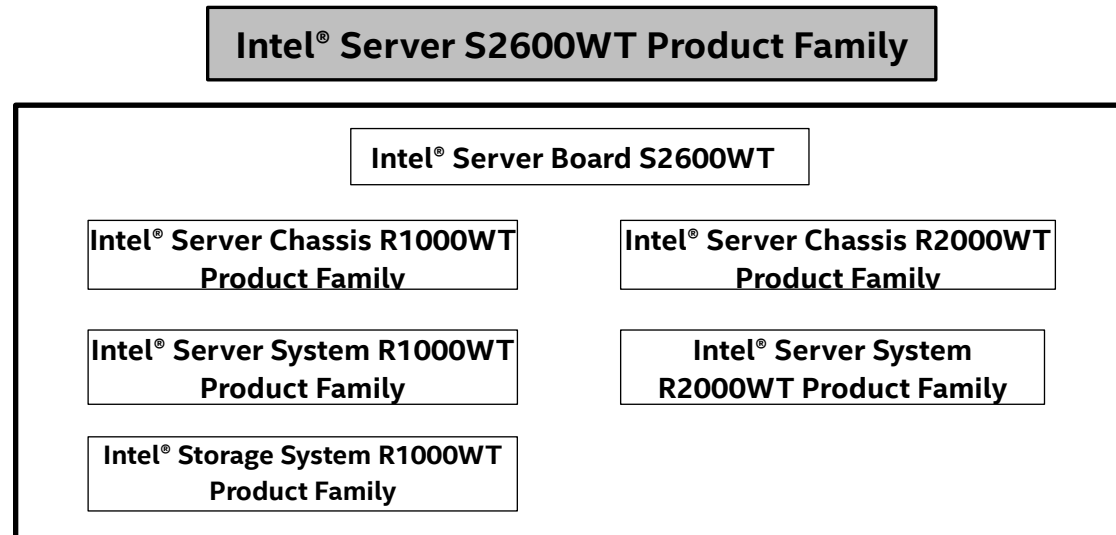

Server Building Blocks:

- **Intel® Server Board S2600WT** – Server Board only (Building block option and spare FRU)
- **Intel® Server Chassis R1000WT product family** – 1U Rack Mount Server Chassis only
- **Intel® Server Chassis R2000WT product family** – 2U Rack Mount Server Chassis only

Integrated Server Systems:

- **Intel® Server System R1000WT product family** – 1U Rack Mount Server System integrated with an Intel® Server Board S2600WT
- **Intel® Server System R2000WT product family** – 2U Rack Mount Server System integrated with an Intel® Server Board S2600WT
- **Intel® Storage System R1000WT product family** – 1U Rack Mount Server System integrated with an Intel® Server Board S2600WT + Intel® NVMe drives

The Intel® Server S2600WT product family supports the following processors and memory:

- Intel® Xeon® processor E5-2600 v3 & v4 product families

Note: Previous generation Intel® Xeon® processors are not supported.

- DDR4 ECC RDIMM 1600, 1866, 2133, 2400
- DDR4 ECC LRDIMM 1600, 1866, 2133, 2400

Additional Information and Software

For additional information about this family of products or any of their supported accessories, refer to the following resources available at <http://www.intel.com/support>.

Table 1. Product Family Reference Collaterals

For this information or software	Use this Document or Software
For in-depth technical information about this product family	<ul style="list-style-type: none"> • Intel® Server Board S2600WT Technical Product Specification • Intel® Server System R1000WT Product Family Technical Product Specification • Intel® Server System R2000WT Product Family Technical Product Specification • Intel® Remote Management Module 4 (Intel® RMM4) and Integrated BMC User Guide • Intel® Remote Management Module 4 Technical Product Specification • Intel® I/O Expansion Modules Hardware Specification • Intel® Server System BIOS Setup Utility Guide • Intel® Server Platform Firmware Specification Update • Product Safety and Regulatory Compliance – For Intel® Server Systems supporting the Intel® Xeon® Processor E5-2600 v3 & v4 product families <p>http://www.intel.com/content/www/us/en/motherboards/server-motherboards/server-board-s2600wt.html?wapkw=s2600wt+product+family</p>
For system integration instructions and service guidance	<ul style="list-style-type: none"> • Intel® Server System R1000WT product family System Integration and Service Guide • Intel® Server System R2000WT product family System Integration and Service Guide <p>http://www.intel.com/content/www/us/en/server-chassis/server-chassis-r1000wt.html http://www.intel.com/content/www/us/en/server-chassis/server-chassis-r2000wt.html</p>
For server configuration guidance and compatibility	Intel® Server Configurator tool http://serverconfigurator.intel.com
For system power budget guidance	Intel® Server Board S2600WT Product Family Power Budget Tool and Thermal Configuration Guide https://downloadcenter.intel.com/product/78562/Intel-Server-Board-S2600WT-Family
For system firmware updates, onboard device drivers, and software to manage your Intel® Server System.	https://downloadcenter.intel.com/product/78562/Intel-Server-Board-S2600WT-Family
For a complete list of supported processors, memory, add-in cards, and peripherals:	http://www.intel.com/content/www/us/en/motherboards/server-motherboards/server-board-s2600wt.html?wapkw=s2600wt+product+family
Product Warranty Information	http://www.intel.com/content/www/us/en/support/services/000005886.html

1.1 Intel® S2600WT Server Chassis and Server System Product Code Naming Convention

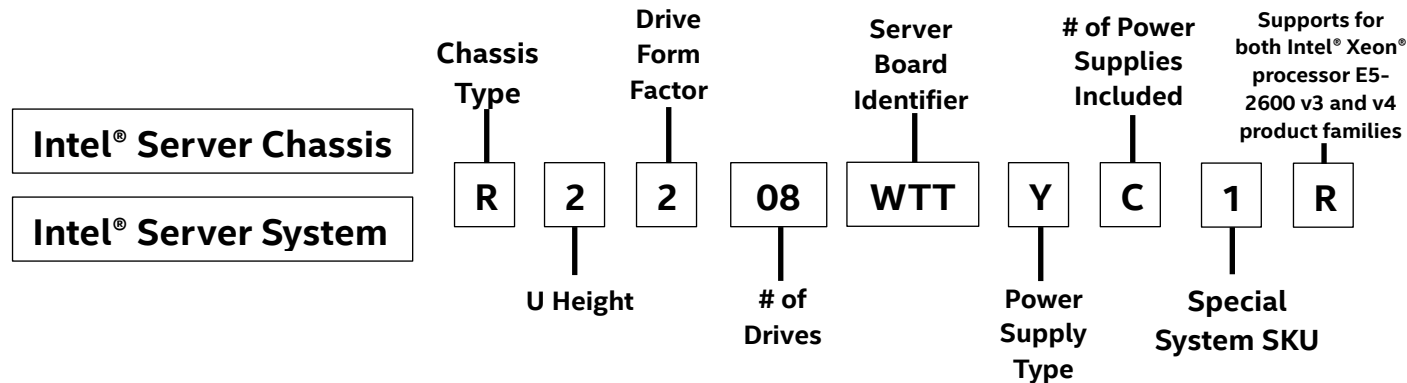

<p>Chassis Type</p> <p>R = RACK MOUNT</p>	<p>Server Board Identifier</p> <p>WT = Intel® Server Board S2600WT product family supported WT2 = Intel® Server Board S2600WT w/1 GbE LOM – iPC S2600WT2 WTT = Intel® Server Board S2600WT w/10 GbE LOM – iPC S2600WTT</p>
<p>U Height</p> <p>1 = 1U 2 = 2U</p>	<p>Power Supply Type Included</p> <p>X = None Included G = 750W Y = 1100W</p>
<p>Drive Form Factor (Specific to front drive bays)</p> <p>0 = No drives supported 2 = 2.5" 3 = 3.5"</p>	<p># of Power Supplies Included</p> <p>X = None S = 1 (Non-redundant) C = 2 (Redundant)</p>
<p># of Drives Supported (Specific to front drive bays)</p> <p>00 12 04 16 08 24</p> <p>Note: 00 product codes have no front mount drive bays. Hot swap drive support can be added with the addition of available drive bay accessory options.</p>	<p>Special System SKU</p> <p># = a sequential number starting with 1 within the product family, identifying a special system SKU that adds a non-standard feature from other offered system SKUs. This last digit may or may not be present on all offered system SKUs.</p>

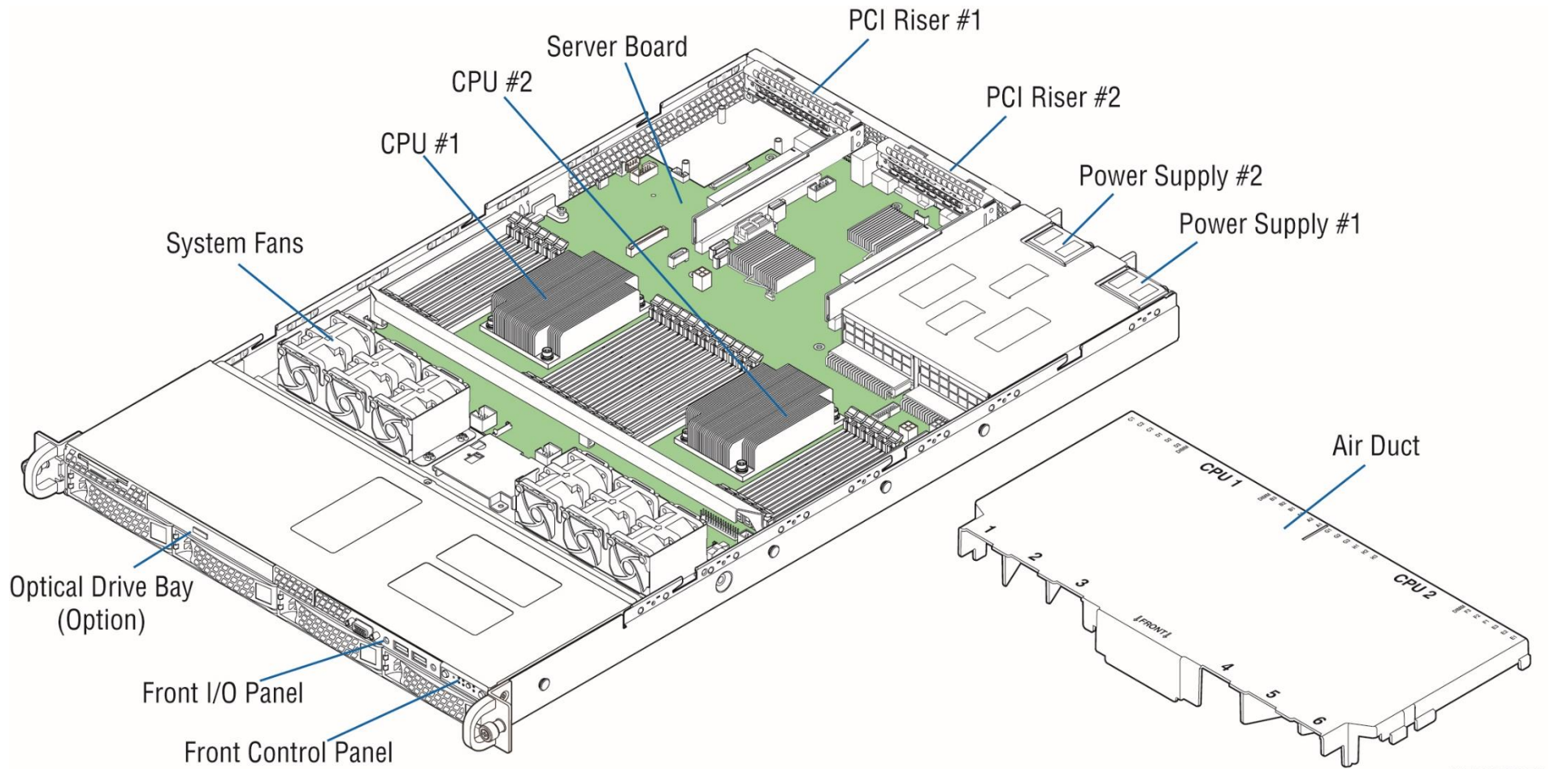

AF006258

Figure 1. Intel® Server System R1000WT Feature Set Identification

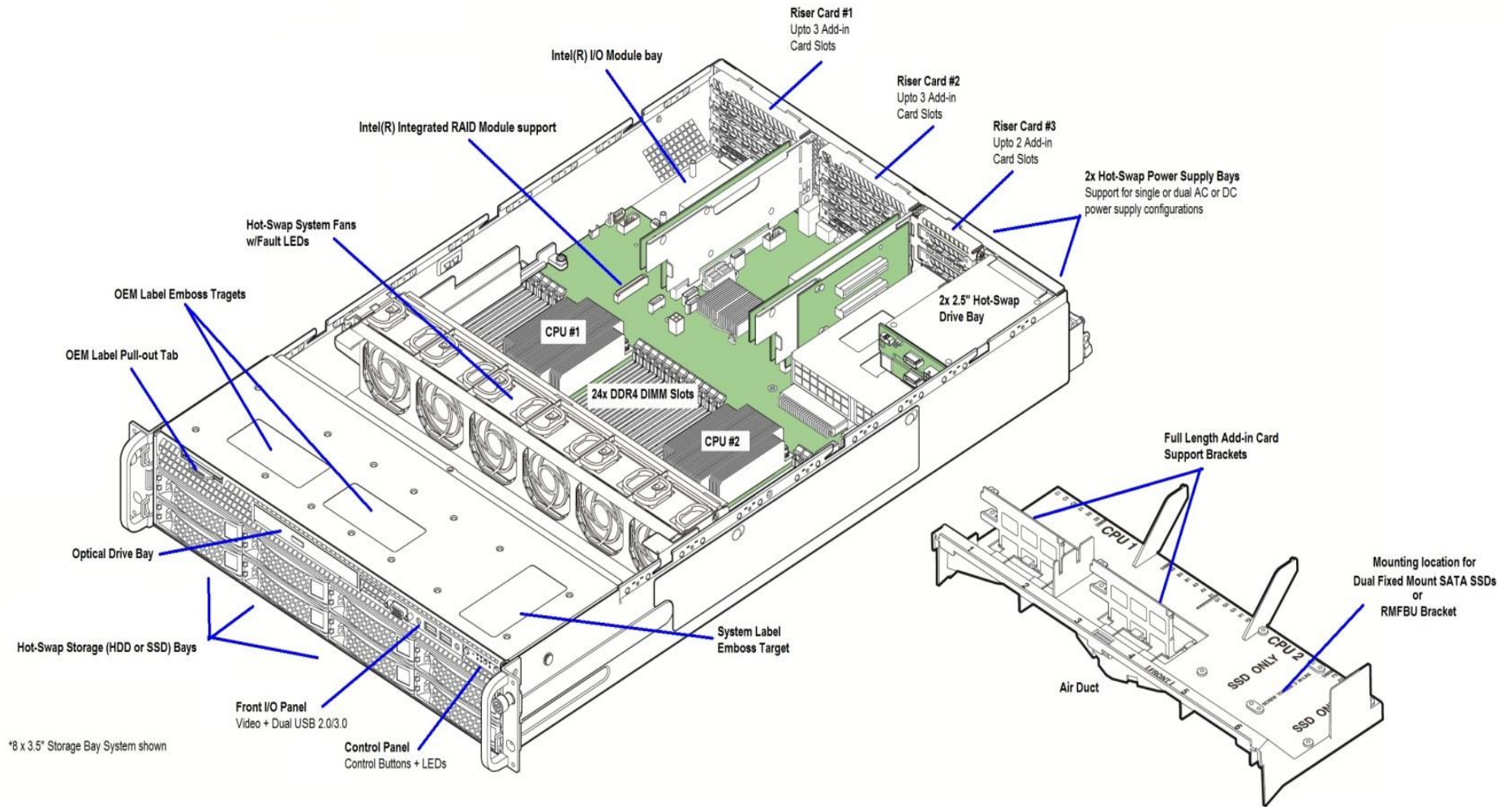

Figure 2. Intel® Server System R2000WT Feature Set Identification

1.2 Product Family Summary Chart

The Intel® S2600WT product family is built around either of two Intel® Server Board S2600WT options: S2600WTT and S2600WT2. The feature set of each server board option is identical except for the onboard LAN controller.

The **S2600WTTR** SKU offers a LAN on Motherboard (LOM) option supporting dual RJ45 10Gb Base-T LAN ports.

The **S2600WT2R** SKU offers a LAN on Motherboard (LOM) option supporting dual RJ45 1Gb Base-T LAN ports.

The **S2600WTTCR** SKU offers a LAN on Motherboard (LOM) option supporting dual RJ45 10Gb Base-T LAN ports and Intel® Platform Firmware Resilience Technology (PFR) and Asset Protect-In-Transit.

The following tables provides an overview of available Intel product codes for building blocks and systems within the Intel® S2600WT product family. Each line item identifies key features supported in the shipping Intel SKU. Additional order code information and full product descriptions for each option are provided in later sections.

Table 2. Server Board Product Family Summary

Intel Product Code	# of CPU sockets	# of DIMM Slots	# of Riser Slots	Onboard RJ45 LAN ports	# of SATA ports (6 Gb)	SATA SW RAID Support	Intel® I/O Module Support	Intel® SAS RAID Module support
Server Board only								
S2600WT2R	2	24	3	2 (1 Gb)	10	Yes	Yes	Yes
S2600WTTTR	2	24	3	2 (10 Gb)	10	Yes	Yes	Yes
S2600WTTTCR	2	24	3	2 (10 Gb)	10	Yes	Yes	Yes

Table 3. Server Chassis & Server/Storage System Product Family Summary

Intel Product Code	Chassis Form Factor	Drive Form Factor	# of Drives (front) ¹	# of Drives (rear)	# of PCIe* Add-in Card Slots	3 rd Riser	Power Supply Modules	Rails	SAS RAID	SAS Expander	PCIe* SFF SSD / NVMe
Chassis Only (KDK)											
R1304WTXXX	1U	3.5"	4	na	opt	na	opt	opt	opt	na	na
R1208WTXXX	1U	2.5"	8	na	opt	na	opt	opt	opt	na	opt
R2312WTXXX	2U	3.5"	12	opt	opt	opt	opt	opt	opt	opt	na
R2000WTXXX ²	2U	opt	opt	opt	opt	opt	opt	opt	opt	opt	opt
2x 10G LOM System (L6 BIK)											
R1304WTTGSR	1U	3.5"	4	na	2	na	1x 750W AC	opt	opt	na	na
R1208WTTGSR	1U	2.5"	8	na	2	na	1x 750W AC	opt	opt	na	opt
R2208WTTYSR	2U	2.5"	8	opt	8	yes	1x 1100W AC	opt	opt	na	opt
R2308WTTYSR	2U	3.5"	8	opt	8	yes	1x 1100W AC	opt	opt	na	na
R2312WTTYSR	2U	3.5"	12	2	6	opt	1x 1100W AC	opt	opt	opt	na

Intel® Server S2600WT Product Family Configuration Guide and Spares/Accessories List

Intel Product Code	Chassis Form Factor	Drive Form Factor	# of Drives (front) ¹	# of Drives (rear)	# of PCIe* Add-in Card Slots	3 rd Riser	Power Supply Modules	Rails	SAS RAID	SAS Expander	PCIe* SFF SSD / NVMe
R2224WTTYSR	2U	2.5"	24	2	6	opt	1x 1100W AC	opt	opt	opt	opt
R2208WTTYC1R ³	2U	2.5"	8	opt	6	yes	2x 1100W AC	opt	opt	na	opt
2x 1G LOM System (L6 BIK)											
R1304WT2GSR	1U	3.5"	4	na	2	na	1x 750W AC	opt	opt	na	na
R1208WT2GSR	1U	2.5"	8	na	2	na	1x 750W AC	opt	opt	na	opt
R2208WT2YSR	2U	2.5"	8	opt	8	yes	1x 1100W AC	opt	opt	na	opt

Table Note References:

- 1 – All front drive bays are 12Gb SAS capable
- 2 – R2000WTXXXR Chassis can support all 8x2.5" drive bay accessory options or 8x3.5" drive bay accessory option
- 3 – System SKU with included system features to support Intel® Xeon Phi™ Coprocessor cards with **passive** (no fan) heat sink solutions. High power add-in cards with **active** cooling solutions are NOT supported in this SKU.
- 4 – Storage System SKU includes 4 Intel® SFF NVMe drives. The remaining four drive bays can support SAS / SATA drives only
- 5 – One PCIe slot is populated with a PCIe Redriver card enabling support for SFF NVMe drives
- 6 – The chassis includes RFID antenna.

Terms used in the table:

- na** – Not Applicable
- opt** – Accessory option sold separately
- yes** – Option included
- KDK** – Knock Down Kit – Intel PCSD term for chassis only product
- BIK** – Server Board in KDK – Intel PCSD term for integrated (L6) system product
- L6** – Integrated system with no processors, memory, or storage devices
- L8** – Integrated system including storage devices, but no processors or memory

1.3 Intel® S2600GZ/GL Product Family to Intel® Server S2600WT Product Family Transition Guide

If transitioning from the previous generation Intel® S2600GZ/GL product family, the following table can be used to identify an equivalent system within the Intel® S2600WT product family.

Table 4. 1U / 2U Server System Product Family Generation to Generation Transition Guide

Prior Generation Product Code	New Generation 1G LOM SKU Product Code	New Generation 10G LOM SKU Product Code	Required accessories to match configuration			Advantages included in current generation
R1208GL4DS	R1208WT2GSR	R1208WTTGSR	AXXELVRAIL	AXXRMM4LITE AXXRMM4LITE2		750 vs460 PSU, 24 vs16DIMM
R1208GZ4GC	R1208WT2GSR	R1208WTTGSR	AXXELVRAIL	AXXRMM4LITE AXXRMM4LITE2	FXX750PCRPS	
R1208GZ4GS9	R1208WT2GSR	R1208WTTGSR				
R1304GL4DS9	R1304WT2GSR	R1304WTTGSR				750 vs460 PSU, 24vs16DIMM
R1304GZ4GC	R1304WT2GSR	R1304WTTGSR	AXXELVRAIL	AXXRMM4LITE AXXRMM4LITE2	FXX750PCRPS	
R1304GZ4GS9	R1304WT2GSR	R1304WTTGSR				
R2208GL4DS9	R2208WT2YSR	R2208WTTYSR				Rear drives option, 1100W vs 460W PSU, 3 rd riser, 24vs16 dimms
R2208GL4GS	R2208WT2YSR	R2208WTTYSR	AXXELVRAIL	AXXRMM4LITE AXXRMM4LITE2		Rear drives option, 1100W vs 750W PSU, 3 rd riser, 24vs16 dimms
R2208GZ4GC	R2208WT2YSR	R2208WTTYSR	AXXELVRAIL	AXXRMM4LITE AXXRMM4LITE2	AXX1100PCRPS	Rear drives option, 1100W vs 750W PSU, 3 rd riser
R2208GZ4GS9	R2208WT2YSR	R2208WTTYSR				Rear drives option, 1100W vs 750W PSU, 3 rd riser
R2224GZ4GC4		R2224WTTYSR	AXXELVRAIL	AXXRMM4LITE AXXRMM4LITE2		Rear drives included, 1100W vs 750W PSU, 3 rd riser optional
R2308GL4GS		R2308WTTYSR	AXXELVRAIL	AXXRMM4LITE AXXRMM4LITE2		Rear drives option, 1100W vs 750W PSU, 3 rd riser, 24vs16 dimms
R2308GZ4GC		R2308WTTYSR	AXXELVRAIL	AXXRMM4LITE AXXRMM4LITE2	AXX1100PCRPS	Rear drives option, 1100W vs 750W PSU, 3 rd riser
R2308GZ4GS9		R2308WTTYSR				Rear drives option, 1100W vs 750W PSU, 3 rd riser
R2312GL4GS		R2312WTTYSR	AXXELVRAIL	AXXRMM4LITE AXXRMM4LITE2		Rear drives included, 1100W vs 750W PSU, 3 rd riser optional, 24vs16 dimms
R2312GZ4GC4		R2312WTTYSR	AXXELVRAIL	AXXRMM4LITE AXXRMM4LITE2	AXX1100PCRPS	Rear drives included, 1100W vs 750W PSU, 3 rd riser optional
R2312GZ4GS9		R2312WTTYSR				Rear drives included, 1100W vs 750W PSU, 3 rd riser optional

1.4 Intel® supported Xeon® Processors E5-2600 v3, v4, Family

Intel® Xeon® Processors E5-2600 v3

Processor SKU	TDP	Base Frequency (GHz)	# of Cores	Cache (MB)
E5-2699 v3	145 W	2.3	18	45
E5-2698 v3	135 W	2.3	16	40
E5-2697 v3	145 W	2.6	14	35
E5-2695 v3	120 W	2.3	14	35
E5-2690 v3	135 W	2.6	12	30
E5-2687W v3	160 W	3.1	10	25
E5-2683 v3	120 W	2.0	14	35
E5-2680 v3	120 W	2.5	12	30
E5-2670 v3	120 W	2.3	12	30
E5-2667 v3	135 W	3.2	8	20
E5-2660 v3	105 W	2.6	10	25
E5-2650L v3	65 W	1.8	12	30
E5-2650 v3	105 W	2.3	10	25
E5-2643 v3	135 W	3.4	6	20
E5-2640 v3	90 W	2.6	8	20
E5-2637 v3	135 W	3.5	4	15
E5-2630L v3	55 W	1.8	8	20
E5-2630 v3	85 W	2.4	8	20
E5-2623 v3	105 W	3.0	4	10
E5-2620 v3	85 W	2.4	6	15
E5-2609 v3	85 W	1.9	6	15
E5-2603 v3	85 W	1.6	6	15

Intel® Xeon® Processors E5-2600 v4

Processor SKU	TDP (W)	Base Frequency (GHz)	Cores	Cache (MB)
E5-2699 v4	145	2.2	22	55
E5-2698 v4	135	2.2	20	50
E5-2697A v4	145	2.6	16	40
E5-2697 v4	145	2.3	18	45
E5-2695 v4	120	2.1	18	45
E5-2683 v4	120	2.1	16	40
E5-2690 v4	135	2.6	14	35
E5-2680 v4	120	2.4	14	35
E5-2660 v4	105	2.0	14	35
E5-2650 v4	105	2.2	12	30
E5-2640 v4	90	2.4	10	25
E5-2630 v4	85	2.2	10	25
E5-2620 v4	85	2.1	8	20
E5-2609 v4	85	1.7	8	20
E5-2603 v4	85	1.7	6	15
E5-2650L v4	65	1.7	14	35
E5-2630L v4	55	1.8	10	25
E5-2687W v4	160	3.0	12	30
E5-2667 v4	135	3.2	8	25
E5-2643 v4	135	3.4	6	20
E5-2637 v4	135	3.5	4	15
E5-2623 v4	85	2.6	4	10

2 Server Building Block Configuration

Server building blocks are offered to give Intel customers the option to configure and assemble a unique server system from the bare chassis up. Each building block component and optional accessory is purchased separately. At a minimum, building up a functional server system using building blocks will require the following:

- 1U or 2U Intel Server Chassis – Intel® Server Chassis R1000WT or R2000WT
- Intel® Server Board S2600WT– S2600WT2R or S2600WTTR
- SAS / SATA Data cables
- Power Supply module(s)
- Power cord(s)
- Rack mount kit – Rails or fixed mount
- Processor
- Memory
- Storage Drives

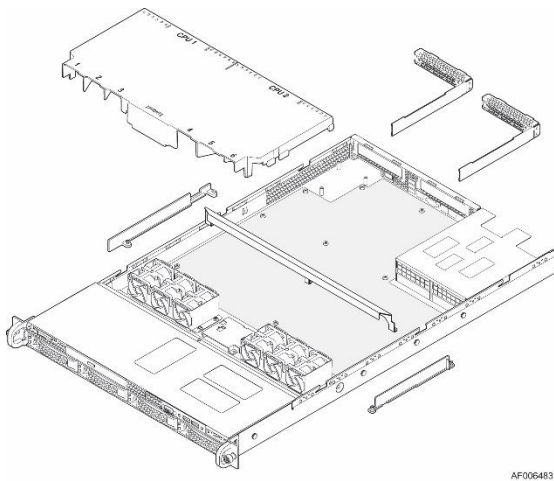

1U – Intel® Server Chassis R1000WT

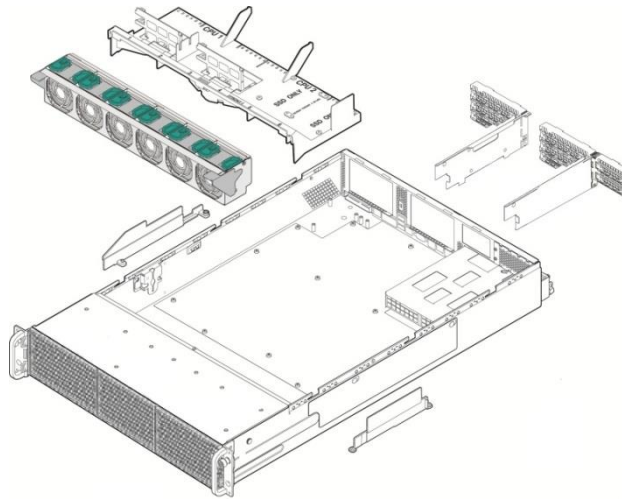

2U – Intel® Server Chassis R2000WT

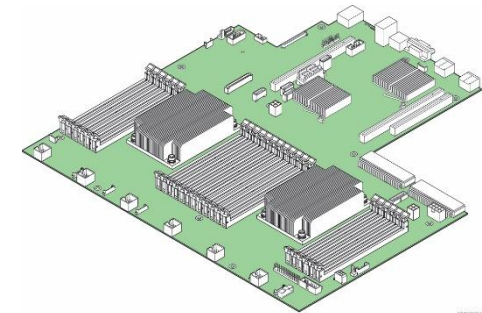

Intel® Server Board S2600WT

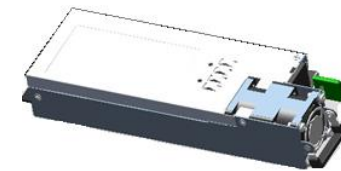

750W or 1100W Power Supply

Optional Intel accessories that can be added include the following: See chapter 5 for available options.

- Riser cards options
- SAS / SAS RAID support – PCIe* add-in card or module + Appropriate SAS Data cable(s)
- Intel® I/O Module

- Intel® Remote Management Module 4 Lite

2.1 Building Block Recipe Summary

The following table is used to identify the building block options required to assemble an equivalent server system SKU offered within the Intel® Server System R1000WT or R2000WT product families.

The first column in the table identifies the available integrated system SKUs. The columns to the right of a specified system SKU identify the Intel building block kits required to assemble the equivalent system.

Table 5. 1U / 2U Building Block to Integrated System Recipe Guide

Intel L6 System Product Code	Building blocks needed to assemble an equivalent system							
	Intel Chassis Product Code	Server Board	Front Drive Bay assembly	Power Supply Modules	Riser Slot 1 and 2 Riser Cards	Riser Slot 3 Riser Card	Rear Drive Bay Assembly	SAS cables for 12Gb
R1304WTTGSR	R1304WTXXX	S2600WTTR	included	(1x) FXX750PCRPS	(2x) F1UL16RISER2	NA	NA	800mm cable AXXCBL1UHRHD
R1304WT2GSR	R1304WTXXX	S2600WT2R	included	(1x) FXX750PCRPS	(2x) F1UL16RISER2	NA	NA	800mm cable AXXCBL1UHRHD
R1208WTTGSR	R1208WTXXX	S2600WTTR	included	(1x) FXX750PCRPS	(2x) F1UL16RISER2	NA	NA	AXXCBL1UHRHD
R1208WT2GSR	R1208WTXXX	S2600WT2R	included	(1x) FXX750PCRPS	(2x) F1UL16RISER2	NA	NA	AXXCBL1UHRHD
R2208WTTYSR	R2000WTXXX	S2600WTTR	A2U8X25S3HSDK	(1x) AXX1100PCRPS	(2x) A2UL8RISER2	A2UX8X4RISER	optional	AXXCBL730HDHD
R2208WTTYC1R	R2000WTXXX + AWTCOPRODUCT	S2600WTTR	A2U8X25S3HSDK	(2x) AXX1100PCRPS	(2x) A2UL16RISER2	A2UX8X4RISER	optional	AXXCBL730HDHD
R2208WT2YSR	R2000WTXXX	S2600WT2R	A2U8X25S3HSDK	(1x) AXX1100PCRPS	(2x) A2UL8RISER2	A2UX8X4RISER	optional	AXXCBL730HDHD
R2224WTTYSR	R2000WTXXX + A2UHANDLKIT	S2600WTTR	(3x) A2U8X25S3HSDK	(1x) AXX1100PCRPS	(2x) A2UL8RISER2	optional	A2UREARHSDK	(2)AXXCBL730HDHD (4) AXXCBL875HDHD
R2308WTTYSR	R2000WTXXX	S2600WTTR	A2U8X35S3HSDK	(1x) AXX1100PCRPS	(2x) A2UL8RISER2	A2UX8X4RISER	optional	1/2 kit of: AXXCBL800HDHD & AXXCBL950HDHD
R2312WTTYSR	R2312WTXXX	S2600WTTR	included	(1x) AXX1100PCRPS	(2x) A2UL8RISER2	optional	A2UREARHSDK	AXXCBL800HDHD AXXCBL875HDHD AXXCBL950HDHD

2.2 Intel® Server Board S2600WT Product Family SKUs

Intel Product Code (iPC)	Order Information	Product Description	Product Type
<p data-bbox="96 448 375 477">iPC – S2600WT2R</p> 	<p data-bbox="415 329 682 467">MM# - 943786 UPC - 00735858308618 EAN - 5032037081375 MOQ - 1</p> <p data-bbox="415 597 726 662">Packaged Gross Weight 3.1 Kgs, 6.8 Lbs</p> <p data-bbox="415 711 726 816">Un-packaged Net Weight 1.7 Kgs, 3.8 Lbs</p>	<p data-bbox="1016 256 1493 285">Intel® Server Board S2600WT2R</p> <ul data-bbox="758 298 1759 862" style="list-style-type: none"> • Support for 1 or 2 Intel® Xeon processor E5-2600 v3 or v4 product family • Maximum supported TDP for board 145W (not available in all chassis configurations) • Intel® C612 chipset • 24 DDR4 DIMM Slots • 8 AHCI SATA 6Gb ports thru two 4-port SFF-8643 connectors • AHCI SATA 6Gb ports for ODD, DOM, SSD thru two 7-pin SATA connectors • 2 Integrated 1Gb ports (Intel® Ethernet Controller I350) • Integrated Baseboard Management controller with IPMI 2.0 support • Optional advanced management features activated by AXXRMM4LITE key or AXXRMM4LITE2 RoHS free key • Dedicated 1Gb management port onboard • Support for up to 3 riser cards with multiple Intel riser card options • NOTE – 2 CPUs required for riser #2 and riser #3 support • Support for Intel® I/O expansion module option • Support for Intel® SAS module option <p data-bbox="758 906 1094 930">Box includes: one server board</p> <p data-bbox="758 938 1759 990">Note: All necessary mounting hardware, cabling, and shielding will ship with the Intel chassis and optional accessory kits.</p>	<p data-bbox="1782 524 1986 548">Server Board only</p> <ul data-bbox="1782 586 2028 678" style="list-style-type: none"> • Building block option • Spare FRU

Intel Product Code (iPC)	Order Information	Product Description	Product Type
<p data-bbox="96 396 378 427">iPC – S2600WTTR</p> 	<p data-bbox="415 293 575 315">MM# - 943785</p> <p data-bbox="415 331 680 352">UPC - 00735858308601</p> <p data-bbox="415 368 669 389">EAN - 5032037081368</p> <p data-bbox="415 406 506 427">MOQ - 1</p> <p data-bbox="415 561 726 630">Packaged Gross Weight 3.1 Kgs, 6.8 Lbs</p> <p data-bbox="415 675 680 777">Un-packaged Net Weight 1.7 Kgs, 3.8 Lbs</p>	<p data-bbox="1016 168 1493 199">Intel® Server Board S2600WTTR</p> <ul data-bbox="758 212 1759 773" style="list-style-type: none"> • Support for 1 or 2 Intel® Xeon processor E5-2600 v3 or v4 product family • Maximum supported TDP for board 145W (not available in all chassis configurations) • Intel® C612 chipset • 24 DDR4 DIMM Slots • 8 AHCI SATA 6Gb ports thru two 4-port SFF-8643 connectors • AHCI SATA 6Gb ports for ODD, DOM, SSD thru two 7-pin SATA connectors • 2 Integrated 10Gb ports (Intel® Ethernet Controller X-540) • Integrated Baseboard Management controller with IPMI 2.0 support • Optional advanced management features activated by AXXRMM4LITE key or AXXRMM4LITE2 RoHS free key • Dedicated 1Gb management port • Support for up to 3 riser cards with multiple Intel riser card options <p data-bbox="810 667 1409 688">Note: 2 CPUs required for riser #2 and riser #3 support</p> <ul data-bbox="758 708 1318 773" style="list-style-type: none"> • Support for Intel® I/O expansion module option • Support for Intel® SAS module option <p data-bbox="758 818 1094 839">Box includes: one server board</p> <p data-bbox="758 849 1759 899">Note: All necessary mounting hardware, cabling, and shielding will ship with the Intel chassis and optional accessory kits.</p>	<p data-bbox="1787 453 1990 474">Server Board Only</p> <ul data-bbox="1787 516 2028 610" style="list-style-type: none"> • Building block option • Spare FRU

Intel Product Code (IPC)	Order Information	Product Description	Product Type
<p style="text-align: center;">IPC – S2600WTTS1R</p> 	<p>MM# - 949339 UPC - 735858315463 EAN - 5032037086462 MOQ - 1</p> <p>Packaged Gross Weight 3.1 Kgs, 6.8 Lbs</p> <p>Un-packaged Net Weight 1.7 Kgs, 3.8 Lbs</p>	<p style="text-align: center;">Intel® Server Board S2600WTTS1R</p> <ul style="list-style-type: none"> • Support for 1 or 2 Intel® Xeon processor E5-2600 v3 or v4 product family • Maximum supported TDP for board 145W (not available in all chassis configurations) • Intel® C612 chipset • 24 DDR4 DIMM Slots • 8 AHCI SATA 6Gb ports thru two 4-port SFF-8643 connectors • AHCI SATA 6Gb ports for ODD, DOM, SSD thru two 7-pin SATA connectors • 2 Integrated 10Gb ports (Intel® Ethernet Controller X-540) • Integrated Baseboard Management controller with IPMI 2.0 support • Optional advanced management features activated by AXXRMM4LITE key or AXXRMM4LITE2 RoHS free key • Integrated TPM 1.2 on board- AXXTPE5 • Dedicated 1Gb management port • Support for up to 3 riser cards with multiple Intel riser card options <p>Note: 2 CPUs required for riser #2 and riser #3 support</p> <ul style="list-style-type: none"> • Support for Intel® I/O expansion module option • Support for Intel® SAS module option <p>Box includes: one server board Note: All necessary mounting hardware, cabling, and shielding will ship with the Intel chassis and optional accessory kits.</p>	<p style="text-align: center;">Server Board Only</p> <ul style="list-style-type: none"> • Building block option • Spare FRU

2.3 Intel® Server Chassis R1000WT Product Family SKUs – (1U Rack Mount Chassis)

The product tables found in this section provide order code information and detailed descriptions for each available 1U Intel server chassis building block option. The lower sections of each table identify:

- The ship along components of the specified chassis product code – (product BOM)
- **Required Items** – Hardware required to be installed to the base system to achieve basic functionality using the default system feature set.
- **Optional Accessories** – Some of the available accessories which can be installed to enhance the basic feature set of the server board / chassis. Additional accessories can be found in Chapter 5.

Note:

- Each **required item** and **optional accessory** is sold separately from the specified Intel server building block.
 - Items identified as **iPC** (Intel Product Code), are an orderable building block option, accessory or spare FRU.
 - In an effort to provide the complete product bill of materials, the ship along components list in each product table will include items identified by description and by **iPN** (Intel Part Number). The iPN information is provided for reference only. These components are **not** orderable as a spare or accessory.
-

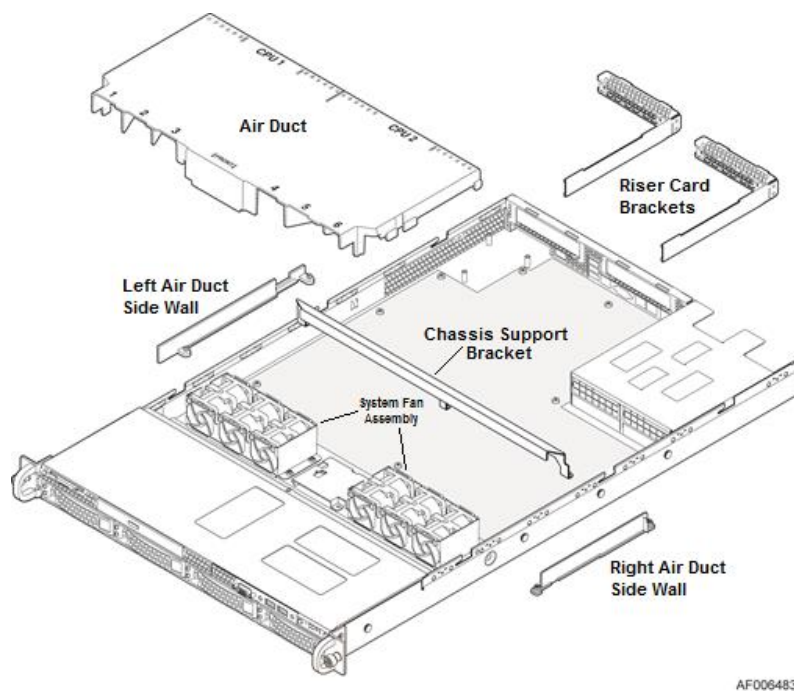
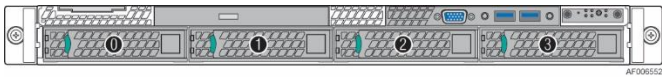
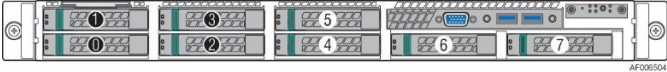

Figure 3. Intel® Server Chassis R1000WT – 1U Chassis only Building Block (KDK)

<p>Intel Product Code (iPC):</p> <p style="text-align: center;">R1304WTXXX</p>  <p style="text-align: center;">1U – 4 x 3.5" HDD or 4 x 2.5" SSD front mount drives</p>	<p>Order Code Information:</p> <p>MM# - 936121 UPC - 00735858287944 EAN - 5032037067492 MOQ - 1</p>	<p>Product Type: Chassis Only Chassis Form Factor: 1U rack mount Chassis dimensions: L=712mm, W=439mm, H=43.2mm Packaged Gross Weight: 19 Kgs, 41.9 Lbs Un-packaged Net Weight: 10.3 Kgs, 22.7 Lbs Outer Box Dimensions: L=983mm, W=577mm, H=260mm</p>
---	---	---

Intel® Server Chassis Product Definition and Configuration Requirements

<p>Intel product code R1304WTXXX includes the following components:</p> <ul style="list-style-type: none"> (1) – 1U Chassis with Quick Reference Label affixed to top cover (1) – Air duct (6) – Dual rotor system fans – iPC FR1UFAN10PW (1) – Pre-installed Standard Control Panel assembly (board only – iPC FXXFPANEL2) (1) – Pre-installed Front I/O Panel assembly (1 x VGA and 2 x USB) (w/internal attach cables) (1) – SATA Optical drive bay with filler panel <ul style="list-style-type: none"> • Includes optical drive mounting latch kit – iPN H19168-00x • Includes optical drive power cable – iPN G95880-00x (4) – 3.5" Hot-swap drive bays with drive carriers and drive blanks <ul style="list-style-type: none"> • includes (1) 12 Gb SAS backplane – iPC FR1304S3HSBP2 • includes (4) 3.5" hot swap drive carriers – iPC FXX35HSCAR (1) – Server board to backplane power cable – iPN H38458-00x (1) – Server board to backplane I2C cable – iPN H39941-00x (2) – CPU heatsinks – iPC FXXCA84X106HS (2) – CPU heat sink Mylar Spacer inserts – iPN H28618-00x (2) – Riser card mounting brackets – (riser cards sold separately. See chapter 5.8.1) (1) – Power Supply Bay blank insert (8) – DIMM slot blanks – iPN H43597-00x (2) – Chassis handles (1 set) installed – iPN H19171-00x (2) – AC Power Cord retention strap assembly – iPN H23961-00x <p>Server board and riser card mounting screws Spares for each screw type included</p>	<p style="text-align: center;"><u>Required Items – Sold Separately:</u></p> <ul style="list-style-type: none"> • Intel® Server Board S2600WT (choose one) <ul style="list-style-type: none"> ○ iPC S2600WT2R – with 1G LOM ○ iPC S2600WTTR – with 10G LOM • Power supply module(s) – (Choose one type) two common modules required for redundancy <ul style="list-style-type: none"> ○ iPC FXX750PCRPS – 750 W AC Power Supply Module ○ iPC AXX750DCCRPS – 750 W DC Power Supply Module (Available Late Q2 2015) • Power Cord(s) – See chapter 5.12 • Rack Mount Kit – See chapter 5.13 • 1 or 2 Intel® Xeon® Processor E5-2600 v3 or v4 product family • ECC DDR4 memory (RDIMM or LRDIMM) 	<p style="text-align: center;"><u>Optional Intel Accessories – Sold Separately:</u></p> <ul style="list-style-type: none"> • iPC F1UL16RISER2 – One x16 PCIe* 3.0 slot Riser Card – (1 for each riser slot) • Intel® I/O Module – See chapter 5.9 for options • Intel® SAS RAID Card / Module – See section 5.10 for options • SAS/SATA Data cables – Cable selection is dependent on desired storage option. See Chapter 4.2.1 for available cable options • iPC A1UBEZEL – Lockable front system bezel • iPC AXXRMM4LITE – Intel® Remote Management Module Lite • iPC AXXRMM4LITE2 – Intel® Remote Management Module Lite “RoHS free • Management Module Lite key. For advanced management features • Storage Drives <p>See Chapter 6 for all available accessory options.</p>
--	---	--

<p>Intel Product Code (iPC):</p> <p style="text-align: center;">R1208WTXXX</p>  <p style="text-align: center;">1U – 8 x 2.5" front mount drives</p>	<p>Order Code Information:</p> <p>MM# - 936187 UPC - 00735858287951 EAN - 5032037067508 MOQ - 1</p>	<p>Product Type: Chassis Only Chassis Form Factor: 1U rack mount Chassis dimensions: L=712mm, W=439mm, H=43.2mm Packaged Gross Weight: 19 Kgs, 41.9 Lbs Un-packaged Net Weight: 10.3 Kgs, 22.7 Lbs Outer Box Dimensions: L=983mm, W=577mm, H=260mm</p>
---	---	---

Intel® Server Chassis Product Definition and Configuration Requirements

<p>Intel product code R1208WTXXX includes the following components:</p> <ul style="list-style-type: none"> (1) – 1U Chassis with Quick Reference Label affixed to top cover (1) – Air duct (6) – Dual rotor system fans – iPC FR1UFAN10PW (1) – Pre-installed Standard control panel assembly (board only iPC FXXFPANEL2) (1) – Pre-installed Front I/O Panel assembly (1 x VGA and 2 x USB) (w/internal attach cables) <ul style="list-style-type: none"> • If removed, can be used as an optical drive bay. • Includes optical drive mounting latch kit – iPN H19168-00x • Includes optical drive power cable – iPN H23851-00x (8) – 2.5" Hot-swap drive bays with drive carriers and drive blanks <ul style="list-style-type: none"> • Includes (1) 12 Gb SAS backplane – iPC F1U8X25S3HSBP • Includes (8) 2.5" hot swap drive carriers – iPC FXX25HSCAR2 (1) – Server board to backplane power cable – iPN H38457-00x (1) – Server board to backplane I2C cable – iPN H39941-00x (2) – CPU heatsinks – iPC FXXCA84X106HS (2) – CPU heat sink Mylar Spacer inserts – iPN H28618-00x (2) – Riser card mounting brackets – (riser cards sold separately. See chapter 5.8.1) (1) – Power Supply Bay blank insert (8) – DIMM slot blanks – iPN H43597-00x (2) – Chassis handles (1 set) installed – iPN H19171-00x (2) – AC Power Cord retention strap assembly – iPN H23961-00x <p>Server board and riser card mounting screws Spares for each screw type included</p>	<p style="text-align: center;">Required Items – Sold Separately:</p> <ul style="list-style-type: none"> • Intel® Server Board S2600WT (choose one) <ul style="list-style-type: none"> ○ iPC S2600WT2R – with 1G LOM ○ iPC S2600WTTR – with 10G LOM • Power supply module(s) – (Choose one type) two common modules required for redundancy <ul style="list-style-type: none"> ○ iPC FXX750PCRPS – 750 W AC Power Supply Module ○ iPC AXX750DCCRPS – 750 W DC Power Supply Module (Available Late Q2 2015) • Power Cord(s) – See chapter 5.12 • Rack Mount Kit – See chapter 5.13 • 1 or 2 Intel® Xeon® Processor E5-2600 v3 or v4 product family • ECC DDR4 memory (RDIMM or LRDIMM) 	<p style="text-align: center;">Optional Intel Accessories – Sold Separately:</p> <ul style="list-style-type: none"> • iPC F1UL16RISER2 – One x16 PCIe* 3.0 slot Riser Card – (1 for each riser slot) • Intel® I/O Module – See chapter 5.9 for options • Intel® SAS RAID Card / Module – See section 5.10 for options • SAS/SATA Data cables – Cable selection is dependent on desired storage option. See Chapter 4.2.2 for available cable options • iPC A1UBEZEL – Lockable front system bezel • iPC AXXRMM4LITE – Intel® Remote • iPC AXXRMM4LITE2 – Intel® Remote Management Module Lite “RoHS free” • Management Module Lite key. For advanced management features • iPC A1U44X25NVMEDK – (4) PCIe* SSD SFF (NVMe*) + (4) SAS support – replaces existing backplane and requires use of one PCIe* slot. See system accessories table or System TPS for details • Storage Drives <p style="text-align: right;">See Chapter 6 for all available accessory options.</p>
---	--	--

2.4 Intel® Server Chassis R2000WT Product Family SKUs – (2U Rack Mount Chassis)

The product tables found in this section provide order code information and detailed descriptions for each available 2U Intel server chassis building block option. The lower sections of each table identify:

- The ship along components of the specified chassis product code – (product BOM)
- **Required Items** – Hardware required to be installed to the base system to achieve basic functionality using the default system feature set
- **Optional Accessories** – Some of the available accessories which can be installed to enhance the basic feature set of the server board / chassis. Additional accessories can be found in Chapter 5

Notes:

- Each **required item** and **optional accessory** is sold separately from the specified Intel server building block
- Items identified as **iPC** (Intel Product Code), are an orderable building block option, accessory or spare FRU
- In an effort to provide the complete product bill of materials, the ship along components list in each product table will include items identified by description and by **iPN** (Intel Part Number). The iPN information is provided for reference only. These components are **not** orderable as a spare or accessory.

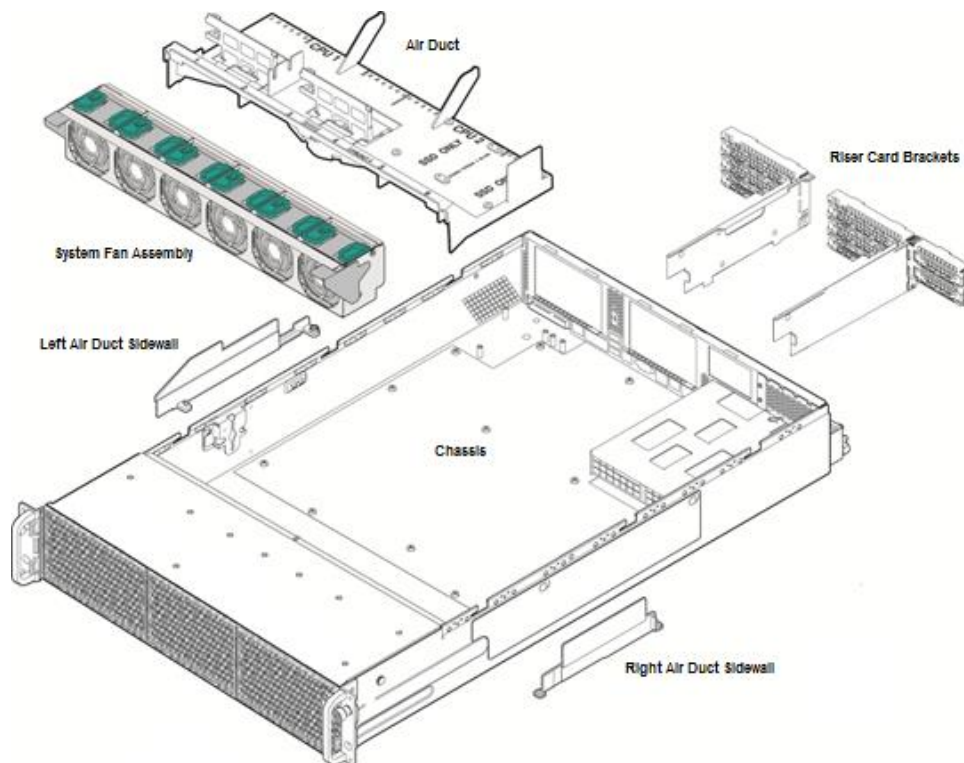
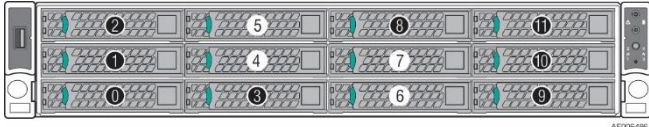
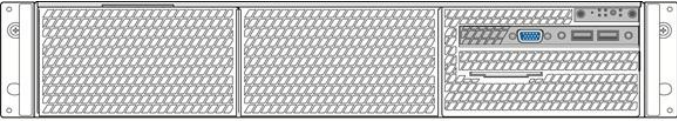

Figure 4. Intel® Server Chassis R2000WT – 2U Chassis only Building Block (KDK)

<p>Intel Product Code (iPC):</p> <p style="text-align: center;">2.4.1 R2312WTXXX</p>  <p style="text-align: center;">2U – 12 x 3.5" HDD or 12 x 2.5" SSD front mount drives</p>	<p>Order Code Information:</p> <p>MM# - 936022 UPC - 00735858288729 EAN - 5032037068000 MOQ - 1</p>	<p>Product Type: Chassis only Chassis Form Factor: 2U rack mount Chassis dimensions: L=712mm, W=439mm, H=89mm Packaged Gross Weight: 21.2 Kgs, 46.7 Lbs Un-packaged Net Weight: 14.4 Kgs, 32.0 Lbs Outer Box Dimensions: L=983mm, W=577mm, H=260mm</p>
---	---	---

Intel® Server Chassis Product Definition and Configuration Requirements

<p>Intel product code R2312WTXXX includes the following components:</p> <ul style="list-style-type: none"> (1) – 2U Chassis with Quick Reference Label affixed to top cover (1) – Air duct (6) – Hot swap system fans – iPC FR2UFAN60HSW (2) – Chassis Handles (1 set) installed, with Integrated control panel & USB Port - iPC A2UHANDLKIT (12) – 3.5" Hot-swap drive bays with drive carriers and drive blanks <ul style="list-style-type: none"> • Includes (1) 12 Gb SAS backplane – iPC F2U12X35S3HSBP – (SAS Data cables sold separately) • Includes (12) 3.5" hot swap drive carriers – iPC FXX35HSCAR (1) – Backplane I2C cable – iPN G92510-00x (1) – Backplane power cable – iPN G92685-00x (1) – Internal fixed mount SSD power cable – iPN H23901-00x (2) – CPU heatsinks – iPC FXXCA84X106HS (2) – CPU heat sink Mylar Spacer inserts – iPN H28618-00x (2) – Riser Card mounting brackets supporting up to 3 riser cards – (risers cards sold separately – See chapter 5.8.2) (1) – Power Supply Bay blank insert (16) – DIMM slot blanks - iPN H43597-00x (1) – 3x RMFBU Mounting Bracket – iPN H18238-00x (2) – AC Power Cord retention strap assembly – iPN H23961-00x <p>Server Board and Riser Card mounting screws Spares for each screw type included</p>	<p>Required Items – Sold Separately:</p> <ul style="list-style-type: none"> • Intel® Server Board S2600WT (choose one) <ul style="list-style-type: none"> ○ iPC S2600WT2R – with 1G LOM ○ iPC S2600WTTR – with 10G LOM • Power supply module(s) – (Choose one type) two common modules required for redundancy <ul style="list-style-type: none"> ○ iPC AXX1100PCRPS – 1100W AC Power Supply Module ○ iPC FXX750PCRPS – 750 W AC Power Supply Module ○ iPC AXX750DCCRPS – 750 W DC Power Supply Module (Available Late Q2 2015) • Power Cord(s) – See chapter 5.12 • Rack Mount Kit – See chapter 5.13 • 1 or 2 Intel® Xeon® Processor E5-2600 v3 or v4 product family • ECC DDR4 memory (RDIMM or LRDIMM) 	<p>Optional Intel Accessories – Sold Separately:</p> <ul style="list-style-type: none"> • Riser Cards – Up to three riser cards can be installed concurrently – See chapter 5.8 • Riser Slots #1 and #2 – Available riser cards include: <ul style="list-style-type: none"> ○ iPC A2UL8RISER2 – (3) x8 PCIe* 3.0 slots ○ iPC A2UL16RISER2 – (1) x16 PCIe* 3.0 slot + (1) x8 PCIe* 3.0 slot • Riser Slot #3 – Available riser cards include: <ul style="list-style-type: none"> ○ iPC A2UX8X4RISER – (1) Low profile x8 PCIe* 3.0 slot + (1) LP x8 PCIe* 2.0 slot • Rear Storage Bay Option – See chapter 5.4 • iPC A2UREARHSDK – Up to (2) hot swap SATA SSDs • Intel® I/O Module – See chapter 5.9 for options • Intel® SAS RAID Card / Module – See section 5.10 for options • Intel® SAS Expander option – See section 4.2.4.2 • SAS/SATA Data cables – Cable selection is dependent on desired storage option. See Chapter 4.2.4 for available cable options • iPC A2UBEZEL – Lockable front system bezel • iPC AXXRMM4LITE – Intel® Remote Management • iPC AXXRMM4LITE2 – Intel® Remote Management Module Lite "RoHS free" • Module Lite key. For advanced management features • Storage Drives <p>See Chapter 5 for all available accessory options.</p>
---	--	--

<p>Intel Product Code (iPC):</p> <p style="text-align: center;">R2000WTXXX</p>  <p style="text-align: center;">2U – No front mount drives</p>	<p>Order Code Information:</p> <p>MM# - 936021 UPC - 00735858287968 EAN - 5032037067515 MOQ - 1</p>	<p>Product Type: Chassis only Chassis Form Factor: 2U rack mount Chassis dimensions: L=712mm, W=439mm, H=89mm Packaged Gross Weight: 19 Kgs, 41.9 Lbs Un-packaged Net Weight: 13.3 Kgs, 29.3 Lbs Outer Box Dimensions: L=983mm, W=577mm, H=260mm</p>
---	---	---

Intel® Server Chassis Product Definition and Configuration Requirements

<p>Intel product code R2000WTXXX includes the following components:</p> <ul style="list-style-type: none"> (1) – 2U Chassis with Quick Reference Label affixed to top cover (1) – Air duct (6) – Hot swap system fans – iPC FR2UFAN60HSW (1) – Pre-installed Standard control panel assembly – (board only iPC FXXFPANEL2) (1) – Pre-installed Front I/O Panel assembly (1 x VGA and 2 x USB) (w/internal attach cables) (1) – SATA Optical drive bay with filler panel and optical drive mounting latch (1) – I2C cable - server board to backplane – iPN G41809-00x (backplane sold separately) (1) – Internal fixed mount SSD / optical drive power cable - iPN H23901-xxx (2) – Riser Card mounting brackets supporting up to 3 riser cards (riser cards sold separately – see chapter 5.8.2) (2) – CPU heatsinks – iPC FXXCA84X106HS (2) – CPU heat sink Mylar Spacer inserts – iPN H28618-00x (1) – Power supply bay blank insert (16) – DIMM slot blanks – iPN H43597-00x (2) – Rack chassis handles (1 set) installed – iPN H18229-xxx (1) – 3x RMFBU Mounting Bracket – iPN H18238-00x (2) – AC Power Cord retention strap assembly – iPN H23961-00x <p>Server Board and Riser Card mounting screws Spares for each screw type included</p>	<p>Required Items – Sold Separately:</p> <ul style="list-style-type: none"> • Intel® Server Board S2600WT (choose one) <ul style="list-style-type: none"> ○ iPC S2600WT2R – with 1G LOM ○ iPC S2600WTTR – with 10G LOM • Power supply module(s) – (Choose one type) two common modules required for redundancy <ul style="list-style-type: none"> ○ iPC AXX1100PCRPS – 1100W AC Power Supply Module ○ iPC FXX750PCRPS – 750 W AC Power Supply Module ○ iPC AXX750DCCRPS – 750 W DC Power Supply Module (Available Late Q2 2015) <ul style="list-style-type: none"> • Power Cord(s) – See chapter 5.12 • Rack Mount Kit – See chapter 5.13 • 1 or 2 Intel® Xeon® Processor E5-2600 v3 or v4 product family • ECC DDR4 memory (RDIMM or LRDIMM) 	<p>Optional Intel Accessories – Sold Separately</p> <ul style="list-style-type: none"> • Front storage bay option <ul style="list-style-type: none"> ○ Upto (3) 8 x 2.5" drive bay modules can be installed: <ul style="list-style-type: none"> ◆ iPC A2U8X25S3HSDK – SAS/SATA ◆ iPC A2U8X25S3DPDK – Dual port SAS ◆ iPC A2U44X25NVMEDK – PCIe* SSD SFF (NVMe) + SAS <p>Note: for a 24 x 2.5" drive configuration, system will lose front video and optical drive support, and system must include the 2U storage front panel in storage handle kit iPC A2UHANDLKIT</p> ○ iPC A2U8X35S3HSDK – 8 x 3.5" drive + Optical drive bay <p>Note: Re-uses control panel and front I/O panel. Includes SAS/SATA data cables and peripheral power cable</p> • Rear Storage Bay Option <ul style="list-style-type: none"> ○ iPC A2UREARHSDK – Up to (2) hot swap SATA SSDs • Riser Cards – Up to three riser cards can be installed concurrently <ul style="list-style-type: none"> ○ Riser Slots #1 and #2 – Available riser cards include: <ul style="list-style-type: none"> ◆ iPC A2UL8RISER2 – (3) x8 PCIe* 3.0 slots ◆ iPC A2UL16RISER2 – (1) x16 PCIe* slot + (1) x8 PCIe* slot ○ Riser Slot #3 – Available riser cards include: <ul style="list-style-type: none"> ◆ iPC A2UX8X4RISER – (1) Low profile x8 PCIe* 3.0 slot + (1) LP x8 PCIe* 2.0 slot • SAS/SATA Data cables – Cable selection is dependent on desired storage option. See Chapter 4 for available cable
---	--	--

		<p>options</p> <ul style="list-style-type: none">• Intel® SAS RAID Card / Module – See section 5.10 for options• Intel SAS Expander Options – See sections 4.2.4.2 & 4.2.5.2• Intel® I/O Module – See chapter 5.9 for options• iPC A2UBEZEL – Lockable front system bezel• iPC AXXMM4LITE – Intel® Remote Management Module Lite• iPC AXXMM4LITE2 – Intel® Remote Management Module Lite, “RoHS free”, key for advanced management features <p>See Chapter 6 for all available accessory options.</p>
--	--	---

3 Server System Configuration

Intel makes available L6 integrated server systems that include a specific server board, power supply module, and hot swap drive bays options. At a minimum, building up a functional L6 server system will require the following:

- Rack mount kit option – Rails or fixed mount
- Power Cord(s)
- Processor(s)
- Memory
- Storage Drives



**Intel® Server/Storage System
R1000WT Product Family**

*R1208WT configuration shown



**Intel® Server System
R2000WT Product Family**

*R2312WT configuration shown

Optional Intel accessories that can be added include the following:

- 2nd power supply module to add power redundancy
- SAS / SAS RAID support – PCIe* add-in card or module + Appropriate SAS Data cable(s)
- Intel® I/O Module
- Intel® Remote Management Module Lite

See chapter 5 for a full list of available options

3.1 Intel® Server/Storage System R1000WT Product Family SKUs – (1U Rack Mount System)

The product tables found in this section provide order code information and detailed descriptions for the specified L6 integrated 1U Intel server system. The lower sections of each table identify:

- The ship along components of the specified system product code – (product BOM)
- **Required Items** – Hardware required to be installed to the base system to achieve basic functionality using the default system feature set
- **Optional Accessories** – Some of the available accessories which can be installed to enhance the basic feature set of the server board / chassis. A full list of accessory options can be found in Chapter 5

Notes:

- Each **required item** and **optional accessory** is sold separately from the specified Intel L6 or L8 server system
 - Items identified as **iPC** (Intel Product Code), are an orderable building block option, accessory or spare FRU
 - In an effort to provide the complete product bill of materials, the ship along components listed in each product table will include items identified by description and by **iPN** (Intel Part Number). The iPN information is provided for reference only. These components are **not** orderable as a spare or accessory.
-



Figure 5. Intel® Server System R1000WT – L6 Integrated 1U System *R1208WTxxx shown

<p>Intel Product Code (iPC):</p> <p style="text-align: center;">R1304WTTGSR</p>  <p>1U – 4 x 3.5" HDD or 4 x 2.5" SSD SAS/SATA front mount drives</p>	<p>Order Code Information:</p> <p>MM# - 943891 UPC – 00735858300865 EAN – 5032037075954 MOQ – 1</p>	<p>Product Type: L6 Integrated System Chassis Form Factor: 1U rack mount Chassis dimensions: L=712mm, W=439mm, H=43.2mm Packaged Gross Weight: 21.3 Kgs, 47.0 Lbs Un-packaged Net Weight: 12.3 Kgs, 27.1 Lbs Outer Box Dimensions: L=983mm, W=577mm, H=260mm</p>
--	---	---

Intel® Server System Product Definition and Configuration Requirements/Options

<p><u>Intel product code R1304WTTGSR includes the following components:</u></p> <ul style="list-style-type: none"> (1) –1U Chassis with Quick Reference Label affixed to top cover (1) – Intel® Server Board S2600WT w/ Dual 10GbE – iPC S2600WTTR (2) – Riser card assembly with single x16 PCIe* slot riser card – iPC F1UL16RISER2 (1) – 750W power supply module - iPC FXX750PCRPS (1) – Power supply bay blank insert (2) – AC Power Cord retention strap assembly – iPN H23961-00x (4) – 3.5" Hot-swap drive bays with drive carriers and drive blanks <ul style="list-style-type: none"> • Includes (1) 12 Gb SAS backplane – iPC FR1304S3HSBP2 • Includes (4) 3.5" hot swap drive trays – iPC FXX35HSCAR (1) – 800mm SAS/SATA Multiport data cable – iPC AXXCBL1UHRHD (1) – 350mm Backplane power cable – iPN H38458-00x (1) – 150mm Backplane I2C cable – iPN H39941-00x (1) – Air duct (6) – Dual rotor system fans – iPC FR1UFAN10PW (1) – Standard control panel assembly (board only – iPC FXXFPANEL2) (1) – Front I/O Panel assembly (1 x VGA and 2 x USB) (1) – SATA Optical drive bay with filler panel – (optical drive sold separately) <ul style="list-style-type: none"> • Includes optical drive mounting latch kit – iPN H19168-00x • Includes 550mm optical drive power cable – iPN G95880-00x (2) – CPU heatsinks – iPC FXXCA84X106HS (2) – CPU heat sink Mylar Spacer inserts – iPN H28618-00x (8) – DIMM slot blanks – iPN G75158-00x (2) – Chassis handle (1 set) installed – iPN H19171-00x <p>Spares for each screw type included</p>	<p style="text-align: center;">Required Items – Sold Separately:</p> <ul style="list-style-type: none"> • Rack Mount Kit – See chapter 5.13 for available options • 1 or 2 Intel® Xeon® Processor E5-2600 v3/v4 product family • ECC DDR4 memory (RDIMM or LRDIMM) • Power Cord(s) – See chapter 5.10 <p>Note: L6 Systems shipping from Intel to North America will include (1) AC power cord</p>	<p style="text-align: center;">Optional Intel Accessories – Sold Separately</p> <p>Note: By default the front drive bays are cabled to on-board SATA only ports. An add-in SAS card or Module is needed to support SAS devices.</p> <ul style="list-style-type: none"> • iPC FXX750PCRPS – 2nd 750W AC Power supply module – to support power redundancy • Intel® 12G SAS RAID module + RMFBU - See chapter 5.10 for available options • SAS Data cable – Depending on the location of the SAS Data controller, a new data cable may be necessary. See chapter 4.2.1 • Intel® I/O Module - See chapter 5.9 for available options • iPC A1UBEZEL – Lockable front system bezel • iPC AXXRMM4LITE - Intel® Remote Management Module • iPC AXXRMM4LITE2 – Intel® Remote RoHS free • Lite key – For advanced management features • iPC RKSATA4R5 – Embedded SATA ESRT2 SW RAID 5 support key • Storage Drives <p>See Chapter 5 for all available accessory options.</p>
--	---	--

<p>Product Code (iPC):</p> <p style="text-align: center;">R1304WT2GSR</p>  <p>1U – 4 x 3.5" HDD or 4 x 2.5" SSD SAS/SATA front mount drives</p>	<p>Order Code Information:</p> <p>MM# – 943892 UPC – 00735858300872 EAN – 5032037075961 MOQ – 1</p>	<p>Product Type: L6 Integrated System Chassis Form Factor: 1U rack mount Chassis dimensions: L=712mm, W=439mm, H=43.2mm Packaged Gross Weight: 21.3 Kgs, 47.0 Lbs Un-packaged Net Weight: 12.3 Kgs, 27.1 Lbs Outer Box Dimensions: L=983mm, W=577mm, H=260mm</p>
--	---	---

Intel® Server System Product Definition and Configuration Requirements/Options

<p><u>Intel product code R1304WT2GSR includes the following components:</u></p> <p>(1) –1U Chassis with Quick Reference Label affixed to top cover (1) – Intel® Server Board S2600WT w/ Dual 1GbE – iPC S2600WT2R (2) – Riser card assembly with single x16 PCIe* slot riser card – iPC F1UL16RISER2 (1) – 750W power supply module - iPC FXX750PCRPS (1) – Power supply bay blank insert (2) – AC Power Cord retention strap assembly – iPN H23961-00x (4) – 3.5" Hot-swap drive bays with drive carriers and drive blanks Includes (1) 12 Gb SAS backplane – iPC FR1304S3HSBP2 Includes (4) 3.5" hot swap drive trays – iPC FXX35HSCAR (1) – 800mm SAS/SATA Multiport data cable – iPC AXXCBL1UHRHD (1) – 350mm Backplane power cable – iPN H38458-00x (1) – 150mm Backplane I2C cable – iPN H39941-00x (1) – Air duct (6) – Dual rotor system fans – iPC FR1UFAN10PW (1) – Standard control panel assembly (board only – iPC FXXFPANEL2) (1) – Front I/O Panel assembly (1 x VGA and 2 x USB) (1) – SATA Optical drive bay with filler panel – (optical drive sold separately) Includes optical drive mounting latch kit – iPN H19168-00x Includes 550mm optical drive power cable – iPN G95880-00x (2) – CPU heatsinks – iPC FXXCA84X106HS (2) – CPU heat sink Mylar Spacer inserts – iPN H28618-00x (8) – DIMM slot blanks – iPN G75158-00x (2) – Chassis handle installed (1 set) – iPN H19171-00x Spares for each screw type included</p>	<p style="text-align: center;">Required Items – Sold Separately:</p> <ul style="list-style-type: none"> • Rack Mount Kit – See chapter 5.13 for available options • 1 or 2 Intel® Xeon® Processor E5-2600 v3 or v4 product family • ECC DDR4 memory (RDIMM or LRDIMM) • Power Cord(s) – See chapter 5.10 <p>Note: L6 Systems shipping from Intel to North America will include (1) AC power cord</p>	<p style="text-align: center;">Optional Intel Accessories – Sold Separately</p> <p>Note: By default the front drive bays are cabled to on-board SATA only ports. An add-in SAS card or Module is needed to support SAS devices.</p> <ul style="list-style-type: none"> • iPC FXX750PCRPS – 2nd 750W AC Power supply module – to support power redundancy • Intel® 12G SAS RAID module + RMFBU - See chapter 5.10 for available options • SAS Data cable – Depending on the location of the SAS Data controller, a new data cable may be necessary. See chapter 4.2.1 • Intel® I/O Module - See chapter 5.9 for available options • iPC A1UBEZEL – Lockable front system bezel • iPC AXXRMM4LITE - Intel® Remote Management Module 4 Lite key – For advanced management features • iPC AXXRMM4LITE2 - Intel® Remote Management "RoHS free" • iPC RKSATA4R5 – Embedded SATA ESRT2 SW RAID 5 support key • Storage Drives <p>See Chapter 5 for all available accessory options.</p>
--	--	--

<p>Product Code (iPC):</p> <p style="text-align: center;">R1208WTTGSR</p>  <p style="text-align: center;">1U – 8 x 2.5" SAS/SATA front mount drives</p>	<p>Order Code Information:</p> <p>MM# – 943893 UPC – 00735858300889 EAN – 5032037075978 MOQ – 1</p>	<p>Product Type: L6 Integrated System Chassis Form Factor: 1U rack mount Chassis dimensions: L=712mm, W=439mm, H=43.2mm Packaged Gross Weight: 21.1 Kgs, 46.5 Lbs Un-packaged Net Weight: 12.9 Kgs, 28.4 Lbs Outer Box Dimensions: L=983mm, W=577mm, H=260mm</p>
--	---	---

Intel® Server System Product Definition and Configuration Requirements/Options

<p><u>Intel product code R1208WTTGSR includes the following components:</u></p> <ul style="list-style-type: none"> (1) – 1U Chassis with Quick Reference Label affixed to top cover (1) – Intel® Server Board S2600WT w/ Dual 10GbE – iPC S2600WTTR (2) – Riser card assembly with single x16 PCIe* 3.0 slot riser card - F1UL16RISER2 (1) – 750W power supply module - iPC FXX750PCRPS (1) – Power supply bay blank insert (2) – AC Power Cord retention strap assembly – iPN H23961-00x (1) – Air duct (6) – Dual rotor system fans – iPC FR1UFAN10PW (1) – Standard control panel assembly (board only – iPC FXXFPANEL2) (1) – Front I/O Panel assembly (1 x VGA and 2 x USB) <ul style="list-style-type: none"> • If removed, can be used as an optical drive bay. • Includes optical drive mounting latch kit – iPN H19168-00x • Includes optical drive power cable – iPN H23851-00x (8) – 2.5" Hot-swap drive bays with drive carriers and drive blanks <ul style="list-style-type: none"> • Includes (1) 12 Gb SAS backplane – iPC F1U8X25S3HSBP • Includes (8) 2.5" hot swap drive trays – iPC FXX25HSCAR2 (1) – 730mm SAS/SATA Multiport data cable – iPC AXXCBL730HRHD (1) – 800mm SAS/SATA Multiport data cable – iPC AXXCBL800HRHD (1) – Backplane power cable – iPN H38458-00x (1) – 200mm Backplane I2C cable – iPN H23846-00x (2) – CPU heatsink – iPC FXXCA84X106HS (8) – DIMM slot blanks – iPN G75158-00x (2) – Chassis handle (1 set) installed - iPN H19171-00x <p>Spares for each screw type included</p>	<p style="text-align: center;">Required Items – Sold Separately:</p> <ul style="list-style-type: none"> • Rack Mount Kit – See chapter 5.13 for available options • 1 or 2 Intel® Xeon® Processor E5-2600 v3 or v4 product family • ECC DDR4 memory (RDIMM or LRDIMM) • Power Cord(s) – See chapter 5.10 <p>Note: L6 Systems shipping from Intel to North America will include (1) AC power cord</p>	<p style="text-align: center;">Optional Intel Accessories – Sold Separately</p> <p>Note: By default the front drive bays are cabled to on-board SATA only ports. An add-in SAS card or Module is needed to support SAS devices.</p> <ul style="list-style-type: none"> • iPC FXX750PCRPS – 2nd 750W AC Power supply module – to support power redundancy • Intel® 12G SAS RAID module + RMFBU - See chapter 5.10 for available options • SAS Data cables – Depending on the location of the SAS Data controller, new data cables may be necessary. See chapter 4.2.2 • Intel® I/O Module - See chapter 5.9 for available options • iPC A1U44X25NVMEDK – (4) PCIe* SSD SFF (NVMe*) + (4) SAS support – replaces existing backplane and requires use of one PCIe* slot. See chapter 5.1 and/or System TPS for details • iPC A1UBEZEL – Lockable front system bezel • iPC AXXRMM4LITE - Intel® Remote Management Module Lite key – For advanced management features • iPC AXXRMM4LITE2 - Intel® Remote Management "RoHS free" • iPC RKSATA4R5 – Embedded SATA ESRT2 SW RAID 5 support key • Storage Drives <p>See Chapter 5 for all available accessory options.</p>
---	--	---

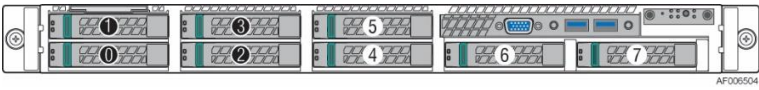
<p>Product Code (iPC):</p> <p style="text-align: center;">3.1.1 R1208WT2GSR</p>  <p style="text-align: center;">1U – 8 x 2.5" SAS/SATA front mount drives</p>	<p>Order Code Information:</p> <p>MM# - 943894 UPC – 00735858300896 EAN – 5032037075985 MOQ – 1</p>	<p>Product Type: L6 Integrated System Chassis Form Factor: 1U rack mount Chassis dimensions: L=712mm, W=439mm, H=43.2mm Packaged Gross Weight: 21.1 Kgs, 46.5 Lbs Un-packaged Net Weight: 12.9 Kgs, 28.4 Lbs Outer Box Dimensions: L=983mm, W=577mm, H=260</p>
--	---	---

Intel® Server System Product Definition and Configuration Requirements/Options

<p><u>Intel product code R1208WT2GSR includes the following components:</u></p> <ul style="list-style-type: none"> (1) – 1U Chassis with Quick Reference Label affixed to top cover (1) – Intel® Server Board S2600WT w/ Dual 1GbE – iPC S2600WT2R (2) – Riser card assembly with single x16 PCIe* 3.0 slot riser card – F1UL16RISER2 (1) – 750W power supply module - iPC FXX750PCRPS (1) – Power supply bay blank insert (2) – AC Power Cord retention strap assembly – iPN H23961-00x (1) – Air duct (6) – Dual rotor system fan – iPC FR1UFAN10PW (1) – Standard control panel assembly (board only – iPC FXXFPANEL2) (1) – Front I/O Panel assembly (1 x VGA and 2 x USB) <ul style="list-style-type: none"> • If removed, can be used as an optical drive bay. • Includes optical drive mounting latch kit – iPN H19168-00x • Includes optical drive power cable – iPN H23851-00x (8) – 2.5" Hot-swap drive bays with drive carriers and drive blanks <ul style="list-style-type: none"> • Includes (1) 12 Gb SAS backplane – iPC F1U8X25S3HSBP • Includes (8) 2.5" hot swap drive trays – iPC FXX25HSCAR2 (1) – 730mm SAS/SATA Multiport data cable – iPC AXXCBL730HRHD (1) – 800mm SAS/SATA Multiport data cable – iPC AXXCBL800HRHD (1) – Server board to backplane power cable – iPN H38458-00x (1) – Server board to backplane I2C cable – iPN H39941-00x (2) – CPU heatsink – iPC FXXCA84X106HS (8) – DIMM slot blanks – iPN G75158-00x (2) – Chassis handle (1 set) installed – iPN H19171-00x <p>Spares for each screw type included</p>	<p style="text-align: center;"><u>Required Items – Sold Separately:</u></p> <ul style="list-style-type: none"> • Rack Mount Kit – See chapter 5.13 for available options • 1 or 2 Intel® Xeon® Processor E5-2600 v3 or v4 product family • ECC DDR4 memory (RDIMM or LRDIMM) • Power Cord(s) – See chapter 5.10 <p>Note: L6 Systems shipping from Intel to North America will include (1) AC power cord</p>	<p style="text-align: center;"><u>Optional Intel Accessories – Sold Separately</u></p> <p>Note: By default the front drive bays are cabled to on-board SATA only ports. An add-in SAS card or Module is needed to support SAS devices.</p> <ul style="list-style-type: none"> • iPC FXX750PCRPS – 2nd 750W AC Power supply module – to support power redundancy • Intel® 12G SAS RAID module + RMFBU - See chapter 5.10 for available options • SAS Data cables – Depending on the location of the SAS Data controller, new data cables may be necessary. See chapter 4.2.2 • Intel® I/O Module - See chapter 5.9 for available options • iPC A1U44X25NVMEDK – (4) PCIe* SSD SFF (NVMe*) + (4) SAS support – replaces existing backplane and requires use of one PCIe* slot. See chapter 5.1 and/or System TPS for details • iPC A1UBEZEL – Lockable front system bezel • iPC AXXRMM4LITE - Intel® Remote Management Module Lite key – For advanced management features • iPC AXXRMM4LITE2 - Intel® Remote Management "RoHS free" • iPC RKSATA4R5 – Embedded SATA ESRT2 SW RAID 5 support key • Storage Drives <p>See Chapter 5 for all available accessory options.</p>
---	---	--

3.2 Intel® Server System R2000WT Product Family SKUs – (2U Rack Mount System)

The product tables found in this section provide order code information and detailed descriptions for the specified L6 integrated 2U Intel server system. The lower sections of each table identify:

- The ship along components of the specified chassis product code – (product BOM)
- **Required Items** – The options required to be installed to the base system to achieve basic functionality using the default system feature set
- **Optional Accessories** – Some of the available accessories which can be installed to enhance the basic feature set of the server board / chassis. Additional accessories can be found in Chapter 5

Notes:

- Each **required item** and **optional accessory** is sold separately from the specified Intel L6 server system.
 - Items identified as **iPC** (Intel Product Code), are an orderable building block option, accessory or spare FRU.
 - In an effort to provide the complete product bill of materials, the ship along components list in each product table will include items identified by description and by **iPN** (Intel Part Number). The iPN information is provided for reference only. These components are **not** orderable as a spare or accessory.
-

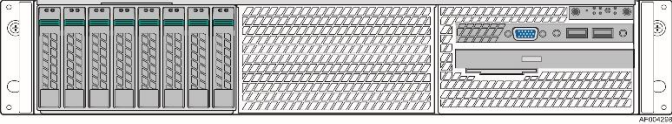
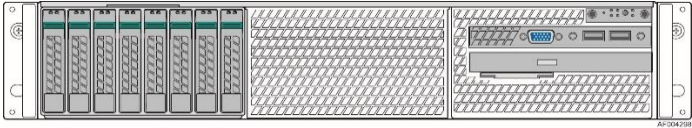

Figure 6. Intel® Server System R2000WT – L6 Integrated 2U System *R2312WTxxx shown

<p>Product Code (iPC):</p> <p style="text-align: center;">3.2.1 R2208WT2YSR</p>  <p style="text-align: center;">2U – 8 x 2.5" front mount drives</p>	<p>Order Code Information:</p> <p>MM# – 943827 UPC – 00735858300919 EAN – 5032037076005 MOQ – 1</p>	<p>Product Type: L6 Integrated System Chassis Form Factor: 2U rack mount Chassis dimensions: L=712mm, W=439mm, H=89mm Packaged Gross Weight: 22.9 Kgs, 50.5 Lbs Un-packaged Net Weight: 16.2 Kgs, 35.7 Lbs Outer Box Dimensions: L=983mm, W=577mm, H=260mm</p>
--	---	---

Intel® Server System Product Definition and Configuration Requirements/Options

<p><u>Intel product code R2208WT2YSR includes the following:</u></p> <ul style="list-style-type: none"> (1) – 2U Chassis with Quick Reference Label affixed to top cover (1) – Intel® Server Board S2600WT w/ Dual 1GbE – iPC S2600WT2R (1) – 1100W AC Power Supply Module – iPC AXX1100PCRPS (1) – Power supply bay blank insert (2) – AC Power Cord retention strap assembly – iPN H23961-00x (2) – PCIe Riser card brackets <ul style="list-style-type: none"> • Includes (2) 3-slot PCIe* riser cards – iPC A2UL8RISER2 • Includes (1) 2-slot low profile PCIe* riser card – iPC A2UX8X4RISER (1) – Air duct (6) – Hot swap system fans – iPC FR2UFAN60HSW (1) – Standard control panel assembly (board only – iPC FXXFPANEL2) (1) – Front I/O Panel assembly (1 x VGA and 2 x USB) (1) – SATA Optical drive bay with filler panel – (optical drive sold separately) Includes optical drive mounting latch kit – iPN H19168-00x Includes 300mm optical drive / internal mount SSD power cable – iPN H23901-00x (8) – 2.5" Hot-swap drive bays with drive carriers and drive blanks Includes (1) 12Gb SAS backplane – iPC A2U8X25S3HSDK Includes (8) 2.5" hot swap drive trays – iPC FXX25HSCAR2 (2) – Multiport 730mm SAS/SATA data cables – iPC AXXCBL730HDHD (1) – Backplane 250mm I2C cable – iPN G41809-00x (1) – Backplane power cable – iPN H23927-00x (2) – CPU heatsinks – iPC FXXCA84X106HS (2) – CPU heat sink Mylar Spacer inserts – iPN H28618-00x (8) – DIMM slot blanks – iPN G75158-00x (2) – Chassis handle (1 set) installed – iPN H18229-xxx (1) – 3x RMFBU Mounting Bracket – iPN H18238-00x Spares for each screw type included 	<p style="text-align: center;"><u>Required Items – Sold Separately:</u></p> <ul style="list-style-type: none"> • Rack Mount Kit – See chapter 5.13 for available options • 1 or 2 Intel® Xeon® Processor E5-2600 v3 or v4 product family • ECC DDR4 memory (RDIMM or LRDIMM) • Power Cord(s) – See chapter 5.10 <p>Note: L6 Systems shipping from Intel to North America will include (1) AC power cord</p>	<p style="text-align: center;"><u>Optional Intel Accessories – Sold Separately</u></p> <p>Note: By default the front drive bays are cabled to on-board SATA only ports. An add-in SAS card or Module is needed to support SAS devices.</p> <ul style="list-style-type: none"> • iPC AXX1100PCRPS – 1100W AC Power Supply Module – to support power redundancy • Intel® I/O Module - See chapter 0 for available options • Intel® 12G SAS RAID module + RMFBU - See chapter 5.10 for available options • SAS Data cables – Depending on the location of the SAS Data controller, new data cables may be necessary. See chapter 4.2.5 • iPC A2U44X25NVMEDK – (4) PCIe* SSD SFF (NVMe*) + (4) SAS support – requires use of one PCIe* slot. See chapter 5.2 and/or System TPS for details • 8x2.5" Drive Bay Module upgrade kit. See chapter 5.6 for available options. • iPC A2UBEZEL – Lockable front system bezel • iPC AXXRMM4LITE - Intel® Remote Management Module Lite key – For advanced management features • iPC AXXRMM4LITE2 - Intel® Remote Management "RoHS free" • iPC RKSATA4R5 – Embedded SATA ESRT2 SW RAID-5 support key • Storage Drives <p>See Chapter 5 for all available accessory options.</p>
---	---	---

<p>Product Code (iPC):</p> <p style="text-align: center;">3.2.2 R2208WTTYSR</p>  <p style="text-align: center;">2U – 8 x 2.5" front mount drives</p>	<p>Order Code Information:</p> <p>MM# – 943826 UPC – 00735858300902 EAN – 5032037075992 MOQ – 1</p>	<p>Product Type: L6 Integrated System Chassis Form Factor: 2U rack mount Chassis dimensions: L=712mm, W=439mm, H=89mm Packaged Gross Weight: 22.9 Kgs, 50.5 Lbs Un-packaged Net Weight: 16.2 Kgs, 35.7 Lbs Outer Box Dimensions: L=983mm, W=577mm, H=260mm</p>
--	---	---

Intel® Server System Product Definition and Configuration Requirements/Options

<p><u>Intel product code R2208WTTYSR includes the following:</u></p> <p>(1) – 2U Chassis with Quick Reference Label affixed to top cover (1) – Intel® Server Board S2600WT w/ Dual 10GbE – iPC S2600WTTR (1) – 1100W AC Power Supply Module – iPC AXX1100PCRPS (1) – Power supply bay blank insert (2) – AC Power Cord retention strap assembly – iPN H23961-00x (2) – PCIe Riser card brackets Includes (2) 3-slot PCIe* riser cards – iPC A2UL8RISER2 Includes (1) 2-slot low profile PCIe* riser card – iPC A2UX8X4RISER (1) – Air duct (6) – Hot swap system fans – iPC FR2UFAN60HSW (1) – Standard control panel assembly (board only – iPC FXFXPANEL2) (1) – Front I/O Panel assembly (1 x VGA and 2 x USB) (1) – SATA Optical drive bay with filler panel – (optical drive sold separately) Includes optical drive mounting latch kit – iPN H19168-00x Includes 300mm optical drive / internal mount SSD power cable – iPN H23901-00x (8) – 2.5" Hot-swap drive bays with drive carriers and drive blanks Includes (1) 12Gb SAS backplane – iPC A2U8X25S3HSDK Includes (8) 2.5" hot swap drive trays – iPC FXX25HSCAR2 (2) – Multiport 730mm SAS/SATA data cables – iPC AXXCBL730HDHD (1) – Backplane 250mm I2C cable – iPN G41809-00x (1) – Backplane power cable – iPN H23927-00x (2) – CPU heatsinks – iPC FXXCA84X106HS (2) – CPU heat sink Mylar Spacer inserts – iPN H28618-00x (8) – DIMM slot blanks – iPN G75158-00x (2) – Chassis handle (1 set) installed – iPN H18229-xxx (1) – 3x RMFBU Mounting Bracket – iPN H18238-00x Spares for each screw type included</p>	<p style="text-align: center;"><u>Required Items – Sold Separately:</u></p> <ul style="list-style-type: none"> • Rack Mount Kit – See chapter 5.13 for available options • 1 or 2 Intel® Xeon® Processor E5-2600 v3 or v4 product family • ECC DDR4 memory (RDIMM or LRDIMM) • Power Cord(s) – See chapter 5.10 <p>Note L6 Systems shipping from Intel to North America will include (1) AC power cord</p>	<p style="text-align: center;"><u>Optional Intel Accessories – Sold Separately</u></p> <p>Note: By default the front drive bays are cabled to on-board SATA only ports. An add-in SAS card or Module is needed to support SAS devices.</p> <ul style="list-style-type: none"> • iPC AXX1100PCRPS – 1100W AC Power Supply Module – to support power redundancy • Intel® I/O Module - See chapter 0 for available options • Intel® 12G SAS RAID module + RMFBU - See chapter 5.10 for available options • SAS Data cables – Depending on the location of the SAS Data controller, new data cables may be necessary. See chapter 4.2.5 • iPC A2U44X25NVMEDK – (4) PCIe* SSD SFF (NVMe*) + (4) SAS support – requires use of one PCIe* slot. See chapter 5.2 and/or System TPS for details • 8x2.5" Drive Bay Module upgrade kit. See chapter 5.6 for available options. • iPC A2UBEZEL – Lockable front system bezel • iPC AXXRMM4LITE - Intel® Remote Management Module Lite key – For advanced management features • iPC AXXRMM4LITE2 - Intel® Remote Management "RoHS free" • iPC RKSATA4R5 – Embedded SATA ESRT2 SW RAID-5 support key • Storage Drives <p>See Chapter 5 for all available accessory options.</p>
--	--	---

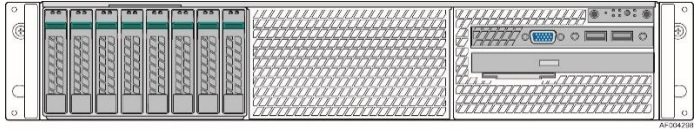
<p>Product Code (iPC):</p> <p style="text-align: center;">3.2.3 R2208WTTYC1R</p>  <p style="text-align: center;">2U – 8 x 2.5" front mount drives</p>	<p>Order Code Information:</p> <p>MM# – 943828 UPC – 00735858300926 EAN – 5032037076012 MOQ – 1</p>	<p>Product Type: L6 Integrated System</p> <p>Special - Features to support passive Intel® Xeon Phi™ coprocessor</p> <p>NOTE: Intel® Xeon Phi™ cards with Active heat sinks are NOT supported in this SKU.</p> <p>Chassis Form Factor: 2U</p> <p>Chassis dimensions: L=712mm, W=439mm, H=89mm</p> <p>Packaged Gross Weight: 22.9 Kgs, 50.5 Lbs</p> <p>Un-packaged Net Weight: 16.2 Kgs, 35.7 Lbs</p> <p>Outer Box Dimensions: L=983mm, W=577mm, H=260mm</p>
<p>Intel® Server System Product Definition and Configuration Requirements/Options</p>		
<p>Intel product code R2208WTTYC1R includes the following:</p> <ul style="list-style-type: none"> (1) – 2U Chassis with Quick Reference Label affixed to top cover (1) – Intel® Server Board S2600WT w/ Dual 10GbE – iPC S2600WTTR (2) – 1100W AC Power Supply Module – iPC AXX1100PCRPS (2) – AC Power Cord retention strap assembly – iPN H23961-00x (2) – PCIe Riser card brackets <p>Includes (2) 2-slot PCIe* riser cards – iPC A2UL16RISER2</p> <p>Includes (1) 2-slot low profile PCIe* riser card – iPC A2UX8X4RISER</p> <ul style="list-style-type: none"> (1) – High air flow air duct (iPC AWTCOPRODUCT) (1) – Intel® Xeon Phi™ / GPGPU Secure Mount Adapter Bracket kit (2) – 12V-Auxiliary Power Cables – iPC AXXGPGPUCABLE (6) – Hot swap system fans – iPC FR2UFAN60HSW (1) – Standard control panel assembly (board only – iPC FXXFPANEL2) (1) – Front I/O Panel assembly (1 x VGA and 2 x USB) (1) – SATA Optical drive bay with filler panel – (optical drive sold separately) <p>Includes optical drive mounting latch kit – iPN H19168-00x</p> <p>Includes 300mm optical drive / internal mount SSD power cable – iPN H23901-00x</p> <ul style="list-style-type: none"> (8) – 2.5" Hot-swap drive bays with drive carriers and drive blanks <p>Includes (1) 12 Gb SAS backplane – iPC A2U8X25S3HSDK</p> <p>Includes (8) 2.5" hot swap drive trays – iPC FXX25HSCAR2</p> <ul style="list-style-type: none"> (2) – Multiport 730mm SAS/SATA data cables – iPC AXXCBL730HDHD (1) – Backplane 250mm I2C cable – iPN G41809-00x (1) – Backplane power cable – iPN H23927-00x (2) – CPU heatsinks – iPC FXXCA84X106HS (2) – CPU heat sink Mylar Spacer inserts – iPN H28618-00x (8) – DIMM slot blanks – iPN G75158-00x (2) – Chassis handle (1 set) installed – iPN H18229-xxx (1) – 3x RMFBU Mounting Bracket – iPN H18238-00x <p>Spares for each screw type included</p>	<p style="text-align: center;"><u>Required Items – Sold Separately:</u></p> <ul style="list-style-type: none"> • Rack Mount Kit – See chapter 5.13 for available options • 1 or 2 Intel® Xeon® Processor E5-2600 v3 or v4 product family • ECC DDR4 memory (RDIMM or LRDIMM) • Power Cord(s) – See chapter 5.10 <p>Note: L6 Systems shipping from Intel to North America will include (2) AC power cords</p>	<p style="text-align: center;"><u>Optional Intel Accessories – Sold Separately</u></p> <p>Note: By default the front drive bays are cabled to on-board SATA only ports. An add-in SAS card or Module is needed to support SAS devices.</p> <ul style="list-style-type: none"> • Intel® I/O Module - See chapter 0 for available options • Intel® 12G SAS RAID module + RMFBU - See chapter 5.10 for available options • SAS Data cables – Depending on the location of the SAS Data controller, new data cables may be necessary. See chapter 4.2.5 • iPC A2U44X25NVMEDK – (4) PCIe* SSD SFF (NVMe*) + (4) SAS support – requires use of one PCIe* slot. See chapter 5.2 and/or System TPS for details • 8x2.5" Drive Bay Module upgrade kit. See chapter 5.6 for available options. • iPC A2UBEZEL – Lockable front system bezel • iPC AXXRMM4LITE - Intel® Remote Management Module Lite key – For advanced management features • iPC AXXRMM4LITE2 - Intel® Remote Management "RoHS free" • iPC RKSATA4R5 – Embedded SATA ESRT2 SW RAID-5 support key • Storage Drives

See Chapter 5 for all available accessory options.

Product Code (iPC):

R2308WTTYSR

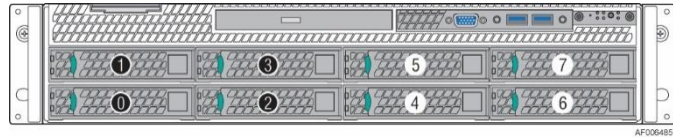

2U – 8 x 3.5" HDD or 8 x 2.5" SSD front mount drives

Order Code Information:

MM# – 943829
 UPC – 00735858300933
 EAN – 5032037076029
 MOQ – 1

Product Type: **L6 Integrated System**
 Chassis Form Factor: **2U rack mount**
 Chassis dimensions: **L=712mm, W=439mm, H=89mm**
 Packaged Gross Weight: **23.5 Kgs, 51.8 Lbs**
 Un-packaged Net Weight: **16.1 Kgs, 35.5 Lbs**
 Outer Box Dimensions: **L=983mm, W=577mm, H=260mm**

Intel® Server System Product Definition and Configuration Requirements/Options

Intel product code R2308WTTYSR includes the following:

- (1) – 2U Chassis with Quick Reference Label affixed to top cover
- (1) – Intel® Server Board S2600WT w/ Dual **10GbE** – iPC **S2600WTTR**
- (1) – 1100W AC Power Supply Module – iPC **AXX1100PCRPS**
- (1) – Power supply bay blank insert
- (2) – AC Power Cord retention strap assembly – iPN H23961-00x
- (2) – PCIe Riser card brackets
- Includes (2) 3-slot PCIe* riser cards – iPC **A2UL8RISER2**
- Includes (1) 2-slot low profile PCIe* riser card – iPC **A2UX8X4RISER**
- (1) – Air duct
- (6) – Hot swap system fans – iPC **FR2UFAN60HSW**
- (1) – Standard control panel assembly (board only – iPC **FXXFPANEL2**)
- (1) – Front I/O Panel assembly (1 x VGA and 2 x USB)
- (1) – SATA Optical drive bay with filler panel – (optical drive sold separately)
- Includes optical drive mounting latch kit – iPN H19168-00x
- Includes 500mm optical drive / internal mount SSD power cable – iPN G95878-00x
- (8) – 3.5" Hot-swap drive bays with drive carriers and drive blanks
 - Includes (1) 12 Gb SAS backplane – iPC **F2U8X35S3HSBP**
 - Includes (8) 3.5" hot swap drive carriers – iPC **FXX35HSCAR**
- (1) – Backplane power cable – iPN H38457-00x
- (1) – Multiport 800mm SAS/SATA data cables – iPC **AXXCBL800HDHD**
- (1) – Multiport 950mm SAS/SATA data cables – iPC **AXXCBL950HDHD**
- (1) – Backplane I2C cable – iPN G92510-00x
- (2) – CPU heatsinks – iPC **FXXCA84X106HS**
- (2) – CPU heat sink Mylar Spacer inserts – iPN H28618-00x
- (8) – DIMM slot blanks – iPN G75158-00x
- (2) – Chassis handle (1 set) installed – iPN H18229-xxx
- (1) – 3x RMFBU Mounting Bracket – iPN H18238-00x
- Spares for each screw type included

Required Items – Sold Separately:

- Rack Mount Kit – See chapter 5.13 for available options
 - 1 or 2 Intel® Xeon® Processor E5-2600 v3 or v4 product family
 - ECC DDR4 memory (RDIMM or LRDIMM)
 - Power Cord(s) – See chapter 5.10
- Note:** L6 Systems shipping from Intel to North America will include (1) AC power cord

Optional Intel Accessories – Sold Separately

Note: By default the front drive bays are cabled to on-board SATA only ports. An add-in SAS card or Module is needed to support SAS devices.

- iPC **AXX1100PCRPS** – 1100W AC Power Supply Module – to support power redundancy
- Intel® I/O Module - See chapter 5.9 for available options
- Intel® 12G SAS RAID module + RMFBU - See chapter 5.10 for available options
- SAS Data cables – Depending on the location of the SAS Data controller, new data cables may be necessary. See chapter 4.2.3
- iPC **A2UBEZEL** – Lockable front system bezel
- iPC **AXXRMM4LITE** - Intel® Remote Management Module Lite key – For advanced management features
- iPC **AXXRMM4LITE2** - Intel® Remote Management "RoHS free"
- iPC **RKSATA4R5** – Embedded SATA ESRT2 SW RAID-5 support key
- Storage Drives

See Chapter 5 for all available accessory options.

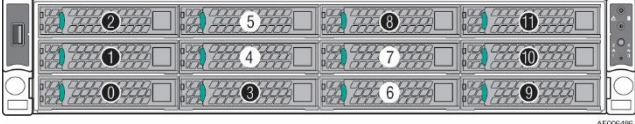
<p>Product Code (iPC):</p> <p style="text-align: center;">R2312WTTYSR</p>  <p style="text-align: center;">2U – 12 x 3.5" HDD or 12 x 2.5" SSD front mount drives</p>	<p>Order Code Information:</p> <p>MM# – 943830 UPC – 00735858300940 EAN – 5032037076036 MOQ – 1</p>	<p>Product Type: L6 Integrated System Chassis Form Factor: 2U rack mount Chassis dimensions: L=712mm, W=439mm, H=89mm Packaged Gross Weight: 24.4 Kgs, 53.8 Lbs Un-packaged Net Weight: 17.0 Kgs, 37.5 Lbs Outer Box Dimensions: L=983mm, W=577mm, H=260mm</p>
--	---	---

Intel® Server System Product Definition and Configuration Requirements/Options

<p>Intel product code R2312WTTYSR includes the following:</p> <ul style="list-style-type: none"> (1) – 2U Chassis with Quick Reference Label affixed to top cover (1) – Intel® Server Board S2600WT w/ Dual 10GbE – iPC S2600WTTR (1) – 1100W AC Power Supply Module – iPC AXX1100PCRPS (1) – Power supply bay blank insert (2) – AC Power Cord retention strap assembly – iPN H23961-00x (2) – PCIe Riser card brackets <ul style="list-style-type: none"> • Includes (2) 3-slot PCIe* riser cards – iPC A2UL8RISER2 (1) – Air duct (6) – Hot swap system fans – iPC FR2UFAN60HSW (2) – Chassis Handles (1 set) installed – includes Integrated control panel & USB Port - iPC A2UHANDLKIT (1) – 500mm internal mount SSD power cable – iPN G95878-00x (12) – 3.5" Hot-swap drive bays with drive carriers and drive blanks <ul style="list-style-type: none"> • Includes (1) 12 Gb SAS backplane – iPC F2U12X35S3HSBP • Includes (12) 3.5" hot swap drive carriers – iPC FXX35HSCAR (1) – Multiport 800mm SAS/SATA data cable – iPC AXXCBL800HDHD (1) – Multiport 875mm SAS/SATA data cable – iPC AXXCBL875HDHD (1) – Multiport 950mm SAS/SATA data cable – iPC AXXCBL950HDHD (1) – Backplane I2C cable – iPN G92510-00x (1) – Backplane power cable – iPN G92685-00x (2) – 2.5" Rear Mount Hot Swap Drive Bays with drive carriers, drive blanks, SATA data/SGPIO cable harness, and I2C cable (Intel Accessory Kit – iPC A2UREARHSDK) (2) – CPU heatsinks – iPC FXXCA84X106HS (2) – CPU heat sink Mylar Spacer inserts – iPN H28618-00x (16) – DIMM slot blanks – iPN G75158-00x (1) – 3x RMFBU Mounting Bracket – iPN H18238-00x <p>Spares for each screw type included</p>	<p style="text-align: center;">Required Items – Sold Separately:</p> <ul style="list-style-type: none"> • Rack Mount Kit – See chapter 5.13 for available options • 1 or 2 Intel® Xeon® Processor E5-2600 v3 or v4 product family • ECC DDR4 memory (RDIMM or LRDIMM) • Power Cord(s) – See chapter 5.10 <p>Note: L6 Systems shipping from Intel to North America will include (1) AC power cord</p>	<p style="text-align: center;">Optional Intel Accessories – Sold Separately</p> <p>Note: When using more than 8 drives a RAID Module or RAID Module + RAID expander should be included. Please refer to section 4.2.5.2 and 4.2.4.2</p> <ul style="list-style-type: none"> • iPC AXX1100PCRPS – 1100W AC Power Supply Module – to support power redundancy • Intel® I/O Module - See chapter 0 for available options • Intel® 12G SAS RAID module + RMFBU - See chapter 5.10 for available options • Intel® SAS Expander – See Chapter 4.2.4.2 for available options • SAS Data cables – Depending on the location of the SAS Data controller, new data cables may be necessary. See chapter 4.2.4 • iPC A2UBEZEL – Lockable front system bezel • iPC AXXRMM4LITE - Intel® Remote Management Module Lite key – For advanced management features • iPC AXXRMM4LITE2 - Intel® Remote Management "RoHS free" • Storage Drives <p>See Chapter 5 for all available accessory options.</p>
---	--	---

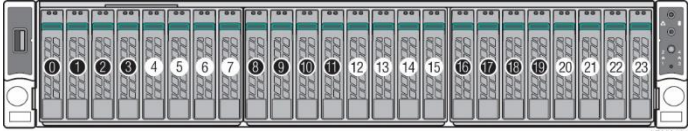
<p>Product Code (iPC):</p> <p style="text-align: center;">R2224WTTYSR</p>  <p style="text-align: center;">2U – 24 x 2.5" front mount drives</p>	<p>Order Code Information:</p> <p>MM# – 943831 UPC – 00735858300957 EAN – 5032037076043 MOQ – 1</p>	<p>Product Type: L6 Integrated System Chassis Form Factor: 2U Chassis dimensions: L=712mm, W=439mm, H=89mm Packaged Gross Weight: 25.0 Kgs, 55.1 Lbs Un-packaged Net Weight: 18.3 Kgs, 40.3 Lbs Outer Box Dimensions: L=983mm, W=577mm, H=260mm</p>
<p>Intel® Server System Product Definition and Configuration Requirements/Options</p>		
<p>Intel product code R2224WTTYSR includes the following:</p> <ul style="list-style-type: none"> (1) – 2U Chassis with Quick Reference Label affixed to top cover (1) – Intel® Server Board S2600WT w/ Dual 10GbE – iPC S2600WTTR (1) – 1100W AC Power Supply Module – iPC AXX1100PCRPS (1) – Power supply bay blank insert (2) – AC Power Cord retention strap assembly – iPN H23961-00x (2) – PCIe Riser card brackets <p>Includes (2) 3-slot PCIe* riser cards – iPC A2UL8RISER2</p> <ul style="list-style-type: none"> (1) – Air duct (6) – Hot swap system fans – iPC FR2UFAN60HSW (2) – Chassis Handles (1 set) installed – includes Integrated control panel & USB Port - iPC A2UHANDLKIT (24) – 2.5" Hot-swap drive bays with drive carriers and drive blanks <p>Includes (3) 12 Gb SAS backplanes – iPC A2U8X25S3HSDK</p> <p>Includes (24) 2.5" hot swap drive trays – iPC FXX25HSCAR2</p> <p>Includes (2) backplane to backplane I2C jumper cables – iPN G17347-00x</p> <ul style="list-style-type: none"> (1) – Backplane power cable – iPN H23927-00x (2) – 2.5" Rear Mount Hot Swap Drive Bays with drive carriers, drive blanks, SATA data/SGPIO cable harness, and I2C cable (Intel Accessory Kit – iPC A2UREARHSDK) (2) – Multiport 730mm SAS/SATA data cables – iPC AXXCBL730HDHD (4) – Multiport 875mm SAS/SATA data cables – iPC AXXCBL875HDHD (1) – Backplane 250mm I2C cable – iPN G41809-00x (1) – Rear Backplane power cable – iPN H24615-00x (2) – CPU heatsinks – iPC FXXCA84X106HS (2) – CPU heat sink Mylar Spacer inserts – iPN H28618-00x (16) – DIMM slot blanks – iPN G75158-00x (2) – Chassis handle (1 set) – iPN H18229-xxx (1) – 3x RMFBU Mounting Bracket – iPN H18238-00x <p>Spares for each screw type included</p>	<p>Required Items – Sold Separately:</p> <ul style="list-style-type: none"> • Rack Mount Kit – See chapter 5.13 for available options • 1 or 2 Intel® Xeon® Processor E5-2600 v3 or v4 product family • ECC DDR4 memory (RDIMM or LRDIMM) • Power Cord(s) – See chapter 5.10 <p>Note: L6 Systems shipping from Intel to North America will include (1) AC power cord</p>	<p>Optional Intel Accessories – Sold Separately</p> <p>Note: When using more than 8 drives a RAID Module or RAID Module + RAID expander should be included. Please refer to section 4.2.5.2 and 4.2.4.2</p> <ul style="list-style-type: none"> • iPC AXX1100PCRPS – 1100W AC Power Supply Module – to support power redundancy • Intel® I/O Module - See chapter 0 for available options • Intel® 12G SAS RAID module + RMFBU - See chapter 5.10 for available options • Intel® SAS Expander – See Chapter 4.2.5.2 for available options • SAS Data cables – Depending on the location of the SAS Data controller, new data cables may be necessary. See chapter 4.2.5 • iPC A2UBEZEL – Lockable front system bezel • iPC AXXRM4LITE - Intel® Remote Management Module Lite key – For advanced management features • iPC AXXRM4LITE2 - Intel® Remote Management "RoHS free" • Storage Drives <p>See Chapter 5 for all available accessory options.</p>

4 SAS / SATA Data Cable Guide

By default, all L6 integrated system will include SAS / SATA data cables routed from the front hot swap backplane to the on-board SATA controller connectors. SAS data cables may need to be ordered separately when adding a SAS RAID module or SAS RAID PCIe* add-in card to an integrated system SKU.

SAS / SATA data cables are NOT included with any of the chassis only building block SKUs. They must be ordered separately to match the desired system configuration.

4.1 SAS / SATA Data Cable Connector Types

There are three storage interface connector types used within this product family:

Single Port SATA Connector

Image	Description
	<p>7-pin Single Port SATA Support for up to 6 GB/sec SATA devices</p> <p>Where used:</p> <ul style="list-style-type: none"> • On the server board – (2) single port SATA connectors (SATA 4, SATA 5) • 2U Rear Mount Hot-Swap Backplane (iPC A2UREARHSDK) • SATA Optical Drive – CD/DVD • SATA DOM

Multiport MiniSAS HD Connectors

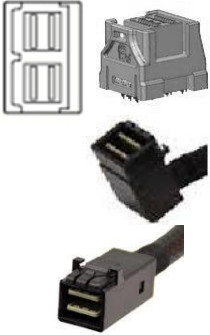
Image	Description
	<p>SFF-8643</p> <ul style="list-style-type: none"> • Support for up to 12 Gb/Sec SAS and 6 Gb/sec SATA devices • PCIe* (NVMe) SFF support associated with Intel Accessory Kits A1U44X25NVMEDK & A2U44X25NVMEDK <p>Where used:</p> <ul style="list-style-type: none"> • On the server board – (2) 4-port SATA connectors (SATA 0-3, sSATA 0-3) • All 12 Gb/sec SAS capable hot swap backplanes • All 12 Gb/sec SAS RAID Controllers • All 12 Gb/sec SAS Expander Cards



Multiport MiniSAS Connector

Image	Description
	<p>SFF-8087 Support for up to 6 Gb/Sec SAS / SATA devices</p> <p>Where used:</p> <ul style="list-style-type: none"> • All 6 Gb/sec SAS RAID Controllers • All 6 Gb/sec SAS Expander Cards

When connecting a 6Gb/sec SAS Controller or SAS Expander to a 12 Gb/sec capable hot swap backplane, the data cables used will need a SFF-8643 connector on one end of the cable and a SFF-8087 connector on the other. See Table 11. Storage Data Cable Kit Description and Order Information for appropriate cable kits.

4.2 1U / 2U Server System SAS / SATA Cable Guide

Product tables in this section will reference SAS/SATA cables using different connector types to meet the connection and routing requirements for the specified system configuration. Each cable reference and product code will identify the connector type at each end of the cable using the following identifiers: **HR**, **HD**, and **MS**. The following table identifies the three cable connector types and their identifiers.

	HR = Right Angle SFF-8643 Mini SAS HD Connector
	HD = Straight SFF-8643 Mini SAS HD Connector
	MS = Straight SFF-8087 Mini SAS Connector (compatible with 6Gb/sec SAS controllers and expanders)

Cable Kit Product Code Example - **AXXCBL950HDMS**

AXXCBL – identifies an accessory cable kit

950 – Identifies the length of the cable

HD – identifies that one end of cable connector supports SFF-8643 connector

System illustrations in each of the following sections will denote drive numbering as shown below:

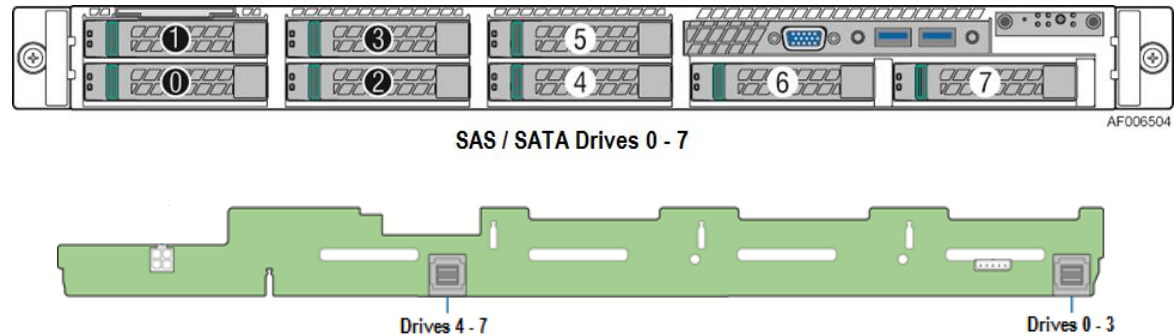

Drive numbering in the system illustrations is for general reference only. Actual drive numbering will be dependent on SAS / SATA controller configuration and how they are cabled to the backplane. Each installed backplane will include a multi-port data connector for each set of four drives. Example for an 8 drive configuration (as shown above), the backplane will include 2 four-port data connectors. In the illustration, drives showing a common color for the Drive ID label will share a common data connector on the backside of the backplane.

Each table in the following sections identify the cable connections and recommended cable lengths for each supported storage controller option in the specified system. Each "recommended" cable length for a given connector pair provides enough cable to attach the two devices and provides the least amount of access cable, providing the cleanest cable routing.

In the given server system, no cables should be routed in front of the system fans or in between the processors and memory slots. All cables that require routing from the front of the system to the back, are routed within the cable channels along the chassis sidewalls.

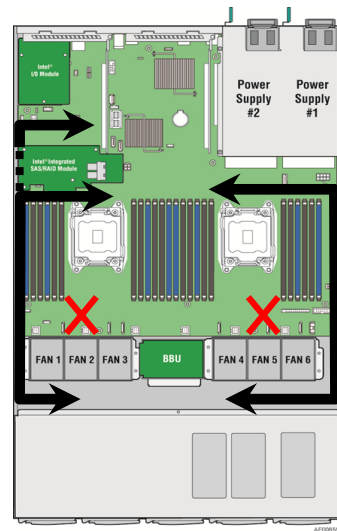

**Intel® Server System R1000WT
product family cable routing**

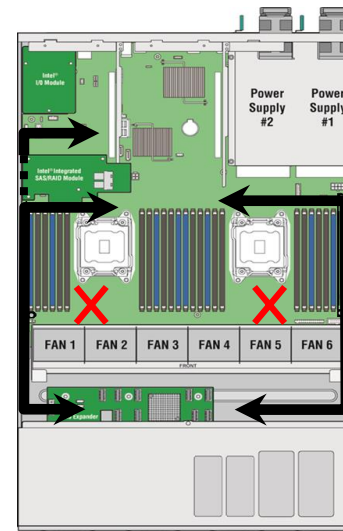

**Intel® Server System R2000WT
product family cable routing**

4.2.1 1U 4 x 3.5" – R1304WTxxx SAS / SATA Data Cable Guide

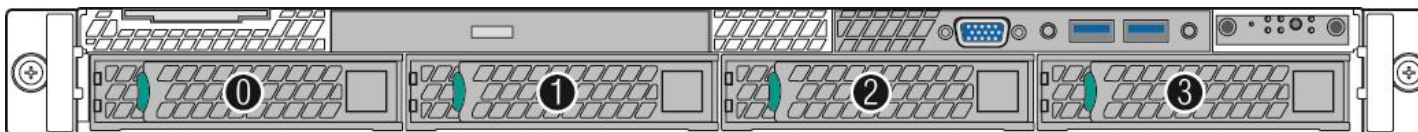

AF006552

System Configuration	Drive Support	Cables for On-board Multi-port SATA Ports to Backplane	Cables for Mezzanine 12 Gb SAS ROC Module to Backplane	Cables for Mezzanine 6 Gb SAS RAID module to Backplane	Cables for 12 Gb SAS RAID PCIe* add-in card to Backplane	Cables for 6 Gb SAS RAID PCIe* add-in card to Backplane
R1304WTxxx R1304WTTGSR R1304WT2GSR	4 x 3.5" 12 Gb SAS capable	Cable Connections: SATA -> BP 0-3 800 mm HR --- HD From data above, select appropriate cable kit from list below: AXXCBL1UHRHD Cable included with L6 Integrated systems	Cable Connections: SAS Mezz -> BP 0-3 800 mm HD --- HD From data above, select appropriate cable kit from list below: AXXCBL800HDHD	Cable Connections: SAS Mezz -> BP 0-3 800 mm HD --- MS From data above, select appropriate cable kit from list below: AXXCBL800HDMS	From Riser #1 Cable Connections: SAS PCIe -> BP 0-3 ** 875 or 950 mm HD --- HD From Riser #2 Cable Connections: SAS PCIe -> BP 0-3 ** 730 or 875 mm HD --- HD From data above, select appropriate cable kits from list below: See ** note below AXXCBL730HDHD AXXCBL875HDHD AXXCBL950HDHD	From Riser #1 Cable Connections: SAS PCIe -> BP 0-3 ** 875 or 950 mm HD --- MS From Riser #2 Cable Connections: SAS PCIe -> BP 0-3 ** 730 or 875 mm HD --- MS From data above, select appropriate cable kits from list below: See ** note below AXXCBL730HDMS AXXCBL875HDMS AXXCBL950HDMS

** 1 or 2 cable lengths may be specified for a PCIe add-in card. Generally, if the cable connector of the add-in card is located on the back edge of the card, a shorter cable is specified. Cable connectors on the top edge or near the front of the add-in card will require the longer cable length.

4.2.2 1U 8 x 2.5" – R1208WTxxx SAS / SATA Data Cable Guide

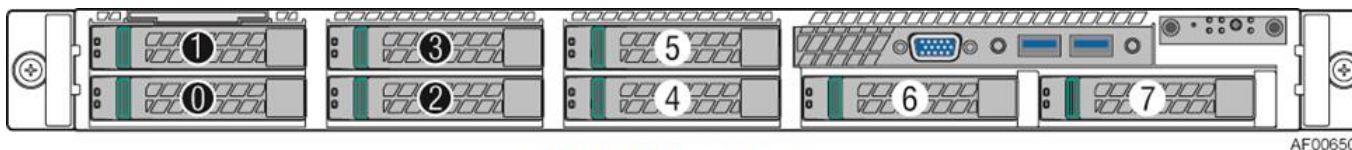

SAS / SATA Drives 0 - 7

AF006504

Note: For data cable information associated with Intel® Accessory Kit A2U44X25NVMEDK, see section 5.1.1

System Configuration	Drive Support	Cables for On-board Multi-port SATA Ports to Backplane	Cables for Mezzanine 12 Gb SAS ROC Module to Backplane	Cables for Mezzanine 6 Gb SAS RAID module to Backplane	Cables for 12 Gb SAS RAID PCIe* add-in card to Backplane	Cables for 6 Gb SAS RAID PCIe* add-in card to Backplane
R1208WTxxx R1208WTTGSR R1208WT2GSR	8 x 2.5" 12 Gb SAS capable	<p>Cable Connections: SATA -> BP 0-3 730 mm HR --- HD</p> <p>sSATA -> BP 4-7 800 mm HR --- HD</p> <p>From data above, select appropriate cable kits from list below:</p> <p>AXXCBL1UHRHD</p> <p>1 of each cable included with L6 Integrated systems</p>	<p>Cable Connections: SAS Mezz -> BP 0-3 650 mm HD --- HD</p> <p>SAS Mezz -> BP 4-7 800 mm HD --- HD</p> <p>From data above, select appropriate cable kits from list below:</p> <p>AXXCBL650HDHD AXXCBL800HDHD</p>	<p>Cable Connections: SAS Mezz -> BP 0-3 650 mm HD --- MS</p> <p>SAS Mezz -> BP 4-7 800 mm HD --- MS</p> <p>From data above, select appropriate cable kits from list below:</p> <p>AXXCBL650HDMS AXXCBL800HDMS</p>	<p>From Riser #1 Cable Connections: SAS PCIe -> BP 0-3 650 mm HD --- HD SAS PCIe -> BP 4-7 ** 730 or 800 mm HD --- HD</p> <p>From Riser #2 Cable Connections: SAS PCIe -> BP 0-3 ** 650 or 730mm HD --- HD SAS PCIe - BP 4-7 ** 800 or 875 mm HD --- HD</p> <p>From data above, select appropriate cable kits from list below: See ** notes below</p> <p>AXXCBL650HDHD AXXCBL730HDHD AXXCBL800HDHD AXXCBL875HDHD</p>	<p>From Riser #1 Cable Connections: SAS PCIe -> BP 0-3 650 mm HD --- MS SAS PCIe -> BP 4-7 ** 730 or 800 mm HD --- MS</p> <p>From Riser #2 Cable Connections: SAS PCIe -> BP 0-3 ** 650 or 730mm HD --- MS SAS PCIe - BP 4-7 ** 800 or 875 mm HD --- MS</p> <p>From data above, select appropriate cable kits from list below: See ** notes below</p> <p>AXXCBL650HDMS AXXCBL730HDMS AXXCBL800HDMS AXXCBL875HDMS</p>

** 1 or 2 cable lengths may be specified for a PCIe add-in card. Generally, if the cable connector of the add-in card is located on the back edge of the card, a shorter cable is specified. Cable connectors on the top edge or near the front of the add-in card will require the longer cable length.

4.2.3 2U 8 x 3.5" – R2308WTxxx Cable Guide

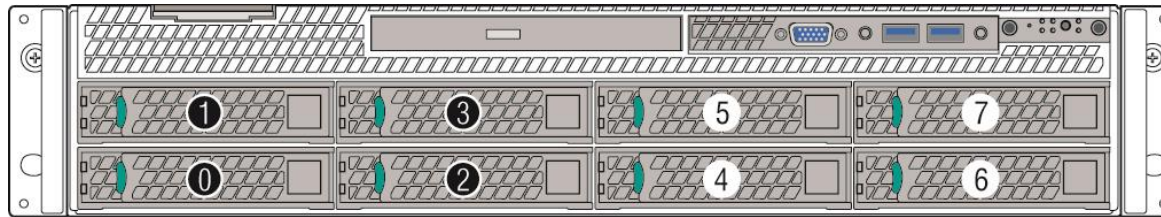

AF006485

System Configuration	Drive Support	Cables for On-board Multi-port SATA Ports to Backplane	Cables for Mezzanine 12 Gb SAS ROC Module to Backplane	Cables for Mezzanine 6 Gb SAS RAID module to Backplane	Cables for 12 Gb SAS RAID PCIe* add-in card to Backplane	Cables for 6 Gb SAS RAID PCIe* add-in card to Backplane
R2308WTTYSR	8 x 3.5" 12 Gb SAS Capable	<p>Cable Connections: SATA -> BP 0-3 800 mm HD --- HD</p> <p>sSATA -> BP 4-7 950 mm HD --- HD</p> <p>From data above, select appropriate cable kits from list below:</p> <p>AXXCBL800HDHD AXXCBL950HDHD</p> <p>1 of each cable included with L6 Integrated systems</p>	<p>Cable Connections: SAS Mezz -> BP 0-3 800 mm HD --- HD</p> <p>SAS Mezz -> BP 4-7 950 mm HD --- HD</p> <p>From data above, select appropriate cable kits from list below:</p> <p>AXXCBL800HDHD AXXCBL950HDHD</p> <p>1 of each cable included with L6 Integrated systems</p>	<p>Cable Connections: SAS Mezz -> BP 0-3 800 mm HD --- MS</p> <p>SAS Mezz -> BP 4-7 950 mm HD --- MS</p> <p>From data above, select appropriate cable kits from list below:</p> <p>AXXCBL800HDMS AXXCBL950HDMS</p>	<p>From Riser #1: Cable Connections: SAS PCIe -> BP 0-3 ** 650 or 730 mm HD --- HD SAS PCIe -> BP 4-7 ** 800 or 950 mm HD --- HD</p> <p>From Riser #2: Cable Connections: SAS PCIe -> BP 0-3 ** 730 or 800 mm HD --- HD SAS PCIe -> BP 4-7 ** 730 or 800 mm HD --- HD</p> <p>From data above, select appropriate cable kits from list below: See ** Notes below</p> <p>AXXCBL650HDHD AXXCBL730HDHD AXXCBL800HDHD (1) 800mm Included in L6 AXXCBL950HDHD (1) 950mm Included in L6</p>	<p>From Riser #1: Cable Connections: SAS PCIe -> BP 0-3 ** 650 or 730 mm HD --- MS SAS PCIe -> BP 4-7 ** 800 or 950 mm HD --- MS</p> <p>From Riser #2: Cable Connections: SAS PCIe -> BP 0-3 ** 730 or 800 mm HD --- MS SAS PCIe -> BP 4-7 ** 730 or 800 mm HD --- MS</p> <p>From data above, select appropriate cable kits from list below: See ** Notes below</p> <p>AXXCBL650HDMS AXXCBL730HDMS AXXCBL800HDMS AXXCBL950HDMS</p>

** 1 or 2 cable lengths may be specified for a PCIe add-in card. Generally, if the cable connector of the add-in card is located on the back edge of the card, a shorter cable is specified. Cable connectors on the top edge or near the front of the add-in card will require the longer cable length.

4.2.4 2U 12 x 3.5 – R2312WTxxx Cable Guide

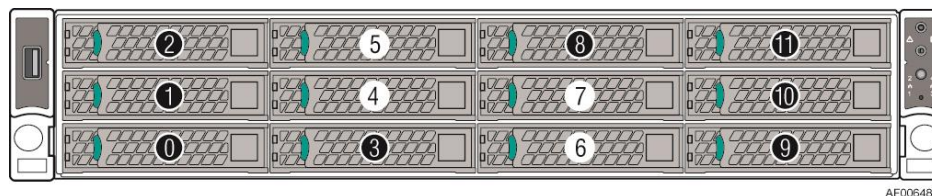

AF006486



4.2.4.1 2U 12 x 3.5" - R2312WTxxx SAS / SATA Data Cable Guide (with No SAS Expander)

System Configuration	Drive Support	Cables for On-board Multi-port SATA Ports to Backplane	Cables for Onboard SATA controller + Mezzanine 12 Gb SAS ROC Module to Backplane	Cables for Onboard SATA Controller + Mezzanine 6 Gb SAS RAID module to Backplane	Cables for Onboard SATA controller + 12 Gb SAS RAID PCIe* add-in card to Backplane	Cables for Onboard SATA controller + 6 Gb SAS RAID PCIe* add-in card to Backplane
R2312WTxxx R2312WTTYSR	12 x 3.5" 12 Gb SAS Capable	<p>Cable Connections: SATA -> BP 0-3 800mm HD --- HD</p> <p>sSATA Cntrl -> BP 4-7 875 mm HD --- HD</p> <p>From data above, select appropriate cable kits from list below:</p> <p>AXXCBL800HDHD AXXCBL875HDHD</p> <p>1 of each cable included with L6 Integrated systems</p>	<p>Cable Connections: SATA -> BP 0-3 800mm HD --- HD</p> <p>SAS Mezz -> BP 4-7 875 mm HD --- HD</p> <p>SAS Mezz -> BP 8-11 950 mm HD ---HD</p> <p>From data above, select appropriate cable kits from list below:</p> <p>AXXCBL800HDHD AXXCBL875HDHD AXXCBL950HDHD</p> <p>1 of each cable included with L6 Integrated systems</p>	<p>Cable Connections: SATA -> BP 0-3 800mm HD --- HD</p> <p>SAS Mezz -> BP 4-7 875 mm HD --- MS</p> <p>SAS Mezz -> BP 8-11 950 mm HD ---MS</p> <p>From data above, select appropriate cable kits from list below:</p> <p>AXXCBL800HDHD AXXCBL875HDMS AXXCBL950HDMS</p>	<p>Cable Connections: SATA -> BP 0-3 800mm HD --- HD</p> <p>From Riser #1 SAS PCIe -> BP 4-7 ** 800 or 875 mm HD --- HD SAS PCIe -> BP 8-11 875 mm HD ---HD</p> <p>From Riser #2 SAS PCIe -> BP 4-7 ** 730 or 875 mm HD --- HD SAS PCIe -> BP 8-11 ** 650 or 800 mm HD --- HD</p> <p>From data above, select appropriate cable kits: See ** Notes below AXXCBL650HDHD AXXCBL730HDHD AXXCBL800HDHD (1) 800mm Included in L6 AXXCBL875HDHD (1) 875mm Included in L6 AXXCBL950HDHD (1) 950mm included in L6)</p>	<p>Cable Connections: SATA -> BP 0-3 800mm HD --- HD</p> <p>From Riser #1 SAS PCIe -> BP 4-7 ** 800 or 875 mm HD --- MS SAS PCIe -> BP 8-11 875 mm HD ---MS</p> <p>From Riser #2 SAS PCIe -> BP 4-7 ** 730 or 875 mm HD --- MS SAS PCIe -> BP 8-11 ** 650 or 800 mm HD --- MS</p> <p>From data above, select appropriate cable kits from list below: See ** Notes below</p> <p>AXXCBL650HDMS AXXCBL730HDMS AXXCBL800HDMS AXXCBL875HDMS AXXCBL950HDMS</p>

** 1 or 2 cable lengths may be specified for a PCIe* add-in card. Generally, if the cable connector of the add-in card is located on the back edge of the card, a shorter cable is specified. Cable connectors on the top edge or near the front of the add-in card will require the longer cable length.

4.2.4.2 2U 12 x 3.5" - R2312WTxxx SAS / SATA Data Cable Guide (with SAS Expander)

SAS drive configurations consisting of more than 8 drives may require the addition of a SAS Expander card. In the 2U 12x3.5" system configuration, the SAS expander must be installed in any available PCIe* add-in slot. Intel provides two SAS expander options to support this drive configuration:

Intel Product Code	Order Information	Product Description	Product Type
 <p>iPC – RES3FV288 Intel® RAID Expander RES3FV288</p>	<p>MM# – 932895 UPC – 00735858287548 EAN – 5032037067287 MOQ = 5</p>	<p>SAS 3.0 12 Gb/s expander</p> <ul style="list-style-type: none"> • Featuring 6Gbps data aggregation for 12Gbps data transfer with 6Gb/s devices • Low Profile MD2 PCIe* add-in card form factor • 28 internal ports and 8 external ports • Redundant dual-port capable for HA and high performance systems • Power from PCIe x1 • HD Mini-SAS 8643 Connectors <p>Kit includes: (1) SAS Expander card, (2) HD-HD 250mm Expander-to-RAID card cables, PCI brackets for Low profile and Full height Required (sold separately): HD-HD SAS DATA Cables – Expander to backplane – See Table 6</p>	<ul style="list-style-type: none"> • 2U Accessory Kit
 <p>iPC – RES2SV240 Intel® RAID Expander RES2SV240</p>	<p>MM# – 908137 UPC – 00735858216289 EAN – 5032037017053 MOQ - 5</p>	<p>SAS 2.0 6 Gb/s expander</p> <ul style="list-style-type: none"> • Low Profile MD2 PCIe* add-in card form factor • 24 Port 6Gb expander card with ports configurable for input or output • Power from PCIe x1 or 4-pin connector • Mini-SAS 8087 connectors <p>Kit includes: (1) 6 Gb/s SAS Expander card, (2) MS-MS 300mm Expander-to-6Gb/s RAID card cables, PCI brackets for Low profile and Full height , (4) MS-MS 650mm Expander-to-Backplane cables (cables not compatible in R2312WTxxx system) Required (sold separately): MS-HD SAS Data Cables – See Table 6</p>	<ul style="list-style-type: none"> • 2U Accessory Kit

<p>iPC – RES2SV240NC</p>  <p>Intel® RAID Expander RES2SV240NC</p>	<p>MM# – 915431 UPC – 00735858221375 MOQ - 5</p>	<p style="text-align: center;">SAS 2.0 6 Gb/s expander</p> <ul style="list-style-type: none"> • Low Profile MD2 PCIe* add-in card form factor • 24 Port 6Gb expander card with ports configurable for input or output • Power from PCIe x1 or 4-pin connector • Mini-SAS 8087 connectors <p>Kit includes: (1) 6 Gb/s SAS Expander card (with no cables), PCI brackets for Low profile and Full height</p> <p>Required (sold separately): MS-HD SAS Data Cables – See Table 6</p>	<ul style="list-style-type: none"> • 2U Accessory Kit
---	--	--	--

Note: The onboard SATA ports are not compatible with SAS Expander cards. The onboard SATA ports can only be cabled directly to a specified backplane.

Table 6. 2U 12 x 3.5" – R2312WTxxx SAS / SATA Data Cable Guide (with SAS Expander)

System Configuration	Drive Support	On-board Multi-port SATA Ports	Mezzanine 12Gb SAS ROC Module + 12 Gb SAS Expander to Backplane	Mezzanine 6 Gb SAS ROC module + 6 Gb SAS Expander to Backplane	12Gb SAS RAID PCIe* add-in card + 12 Gb SAS Expander to Backplane	6Gb SAS RAID PCIe* add-in card + 6 Gb SAS Expander to Backplane
<p>R2312WTxxx R2312WTTYSR</p>	<p>12 x 3.5" 12 Gb SAS Capable</p>	<p>Onboard SATA controllers do not support SAS expanders.</p> <p>If attaching the onboard SATA controller to the Backplane, then use cables that are included in the System SKUs.</p> <p>For building block integration use cable kits: AXXCBL800HDHD AXXCBL875HDHD</p>	<p>With 12 Gb SAS Expander RES3FV288 installed in Riser #1:</p> <ul style="list-style-type: none"> - Use cables in Expander Kit to attach SAS ROC to Expander Card - Use the following cables to attach Expander to Backplane: <p>Expander -> BP 0-3 800 mm HD --- HD</p> <p>Expander -> BP 4-7 875 mm HD --- HD</p> <p>Expander -> BP 8-11 950 mm HD ---HD</p> <p>1 of each cable</p>	<p>With 6 Gb SAS Expander RES2SV240 installed in Riser #1:</p> <ul style="list-style-type: none"> - Use cables in Expander Kit to attach SAS ROC to Expander Card - Use the following cables to attach Expander to Backplane: <p>Expander -> BP 0-3 800 mm HD --- MS</p> <p>Expander -> BP 4-7 875 mm HD --- MS</p> <p>Expander -> BP 8-11 950 mm HD ---MS</p> <p>From data above,</p>	<p>With 12 Gb PCIe RAID and 12 Gb SAS Expander RES3FV288 installed in riser #1:</p> <ul style="list-style-type: none"> - Use cables in Expander Kit to attach PCIe SAS card to Expander Card - Use the following cables to attach Expander to Backplane: <p>Expander -> BP 0-3 800 mm HD --- HD</p> <p>Expander -> BP 4-7 875 mm HD --- HD</p> <p>Expander -> BP 8-11 950 mm HD ---HD</p>	<p>With 6 Gb PCIe RAID and 6 Gb SAS Expander RES2SV240 installed in riser #1:</p> <ul style="list-style-type: none"> - Use cables in Expander Kit to attach PCIe SAS card to Expander Card - Use the following cables to attach Expander to Backplane: <p>Expander -> BP 0-3 800 mm HD --- MS</p> <p>Expander -> BP 4-7 875 mm HD --- MS</p> <p>Expander -> BP 8-11 950 mm HD ---MS</p>

Intel® Server S2600WT Product Family Configuration Guide and Spares/Accessories List

			<p>included with L6 Integrated systems</p> <p>From data above, select appropriate cable kits from list below:</p> <p>AXXCBL800HDHD AXXCBL875HDHD AXXCBL950HDHD</p>	<p>select appropriate cable kits from list below:</p> <p>AXXCBL800HDMS AXXCBL875HDMS AXXCBL950HDMS</p>	<p>From data above, select appropriate cable kits from list below:</p> <p>AXXCBL800HDHD AXXCBL875HDHD AXXCBL950HDHD</p>	<p>From data above, select appropriate cable kits from list below:</p> <p>AXXCBL800HDMS AXXCBL875HDMS AXXCBL950HDMS</p>
--	--	--	--	---	--	--

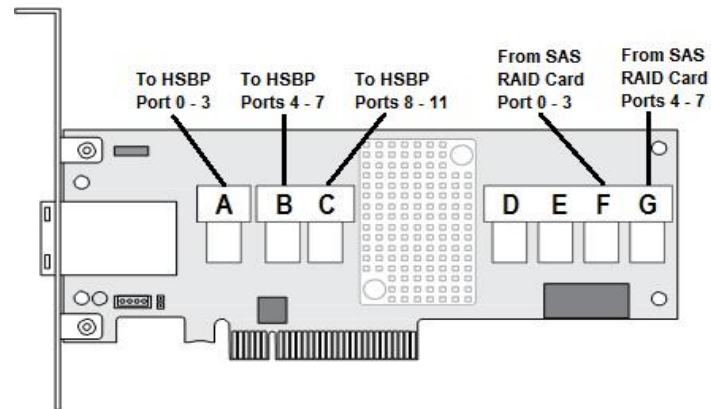

Figure 7. Intel® RAID Expander RES3FV288 Connector Identification

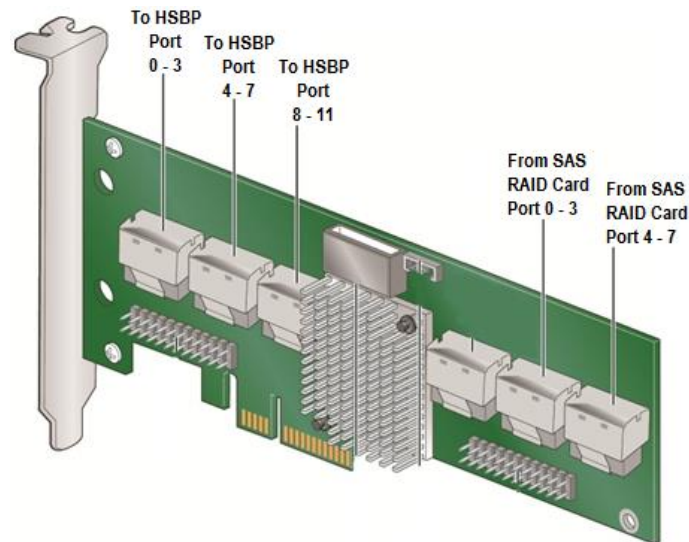
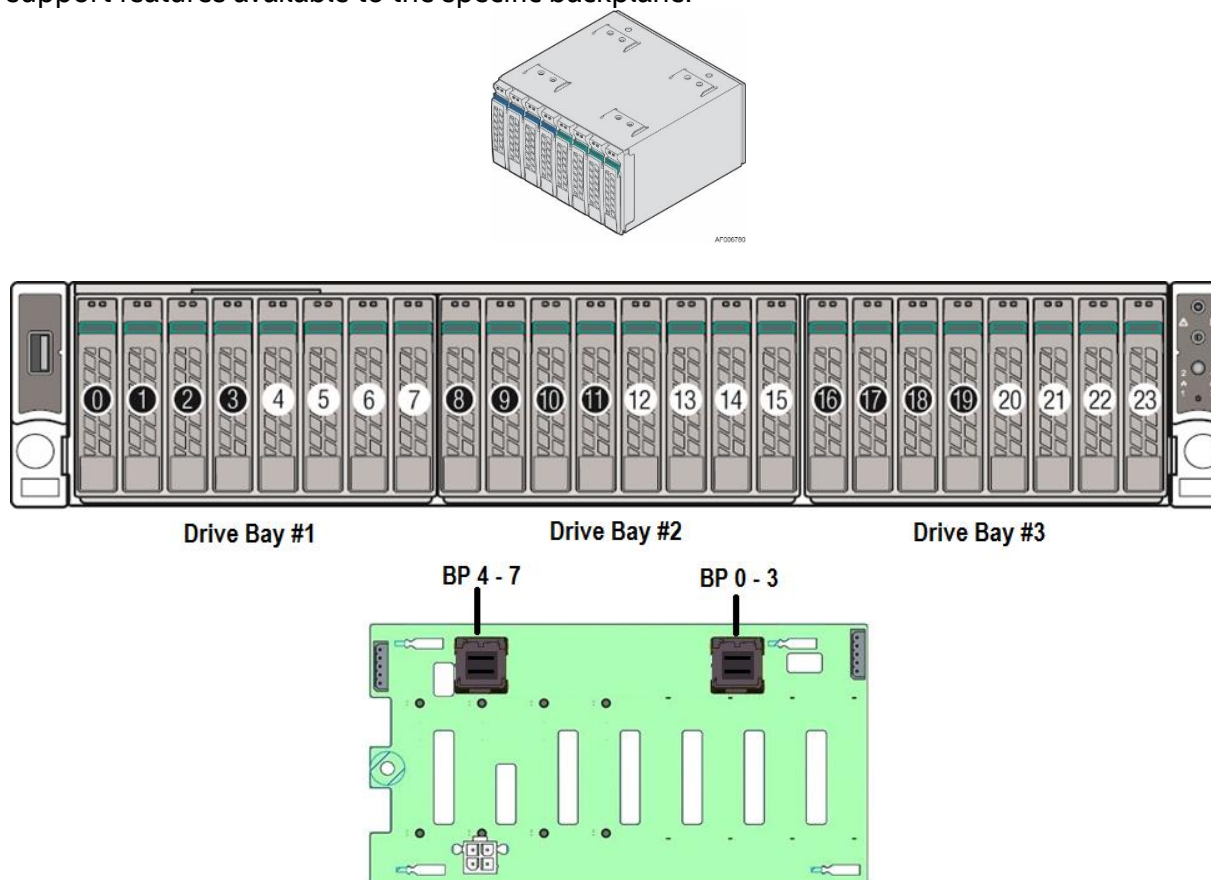

Figure 8. Intel® RAID Expander RES2SV240 Connector Identification

4.2.5 2U 2.5" Front Mount Drive Bay Cable Guide

The front drive bay of the 2U system can support up to three 8x2.5" drive bay modules capable of supporting system configurations of 8 (R2208), 16 (R2216), or 24 (R2224) drives. Each 8x2.5" drive bay is numbered in sequence from 1 to 3, as shown below. Each installed 8x2.5" backplane will include at least two multi-port 8643 data connectors, each supporting a set of four drives. Note that some 8x2.5" backplane options include more than two 8643 connectors in order to support features available to the specific backplane.



Intel makes available several different 8x2.5" drive bay module options, each supporting a different feature set (see chapter 5). The system tables in this section define the SAS/SATA data cables required to support the specified drive bay location regardless of the backplane option installed.

Reference each table as appropriate to determine the cable requirements relevant to your specific drive bay configuration.

Note: For data cable information associated with Intel® Accessory Kit A2U44X25NVMEDK, see sections 5.2.1 and 5.2.2

4.2.5.1 2U 2.5" Front Mount Drive Configurations – SAS Data Cable Guide (with no SAS Expander)

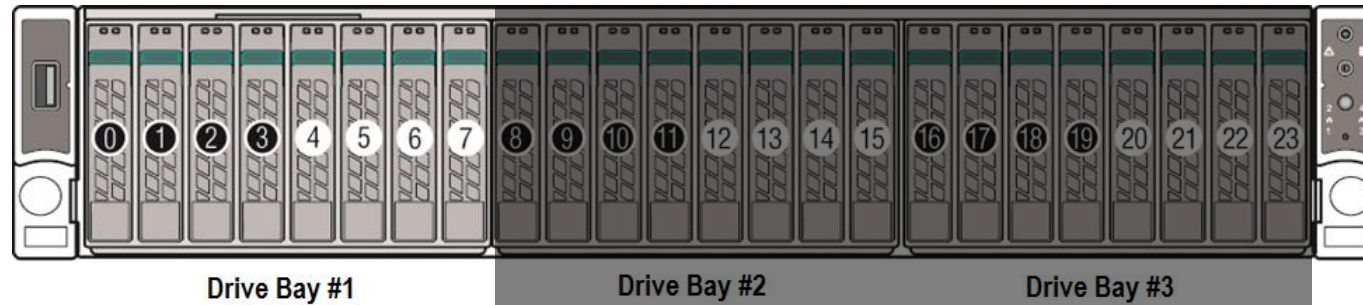
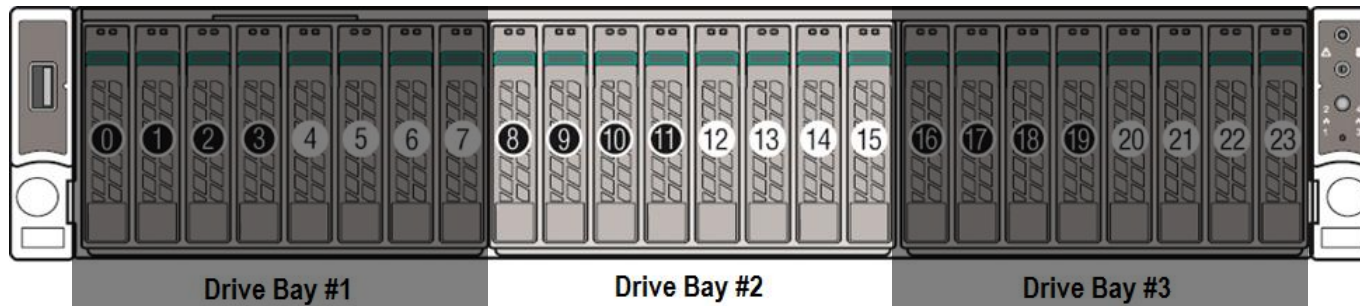

Table 7. 2U 8 x 2.5" (Drive Bay #1) - SAS/SATA Data Cable Guide (with no SAS Expander)

System Configuration	Drive Support	Cables for On-board Multi-port SATA Ports to Drive Bay #1	Cables for Mezzanine 12 Gb SAS ROC Module to Drive Bay #1	Cables for Mezzanine 6 Gb SAS RAID module to Drive Bay #1	Cables for 12 Gb SAS RAID PCIe* add-in card to Drive Bay #1	Cables for 6 Gb SAS RAID PCIe* add-in card to Drive Bay #1
Drive Bay #1 R2208... R2216... R2224...	8 x 2.5"	<p>Cable Connections: SATA Cntrl -> BP 0-3 730mm HD --- HD</p> <p>sSATA Cntrl -> BP 4-7 730 mm HD --- HD</p> <p>From data above, select appropriate cable kits from list below:</p> <p>AXXCBL730HDHD</p> <p>(2) 730mm Cables included with all 2.5" L6 Integrated systems</p>	<p>Cable Connections: SAS Mezz -> BP 0-3 730 mm HD --- HD</p> <p>SAS Mezz -> BP 4-7 730 mm HD --- HD</p> <p>From data above, select appropriate cable kits from list below:</p> <p>AXXCBL730HDHD</p> <p>(2) 730mm Cables included with all 2.5" L6 Integrated systems</p>	<p>Cable Connections: SAS Mezz -> BP 0-3 730 mm HD --- MS</p> <p>SAS Mezz -> BP 4-7 730 mm HD --- MS</p> <p>From data above, select appropriate cable kits from list below:</p> <p>AXXCBL730HDMS</p>	<p>From Riser #1: Cable Connections:</p> <p>SAS PCIe -> BP 0-3 730 mm HD --- HD</p> <p>SAS PCIe -> BP 4-7 730 mm HD --- HD</p> <p>From Riser #2 SAS PCIe -> BP 0-3 730 mm HD --- HD</p> <p>SAS PCIe -> BP 4-7 730 mm HD --- HD</p> <p>From data above, select appropriate cable kits from list below:</p> <p>AXXCBL730HDHD</p> <p>(2) 730mm Cables included with all 2.5" L6 Integrated systems</p>	<p>From Riser #1: Cable Connections:</p> <p>SAS PCIe -> BP 0-3 730 mm HD --- MS</p> <p>SAS PCIe -> BP 4-7 730 mm HD --- MS</p> <p>From Riser #2 SAS PCIe -> BP 0-3 730 mm HD --- MS</p> <p>SAS PCIe -> BP 4-7 730 mm HD --- MS</p> <p>From data above, select appropriate cable kits from list below:</p> <p>AXXCBL730HDMS</p>

** 1 or 2 cable lengths may be specified for a PCIe add-in card. Generally, if the cable connector of the add-in card is located on the back edge of the card, a shorter cable is specified. Cable connectors on the top edge or near the front of the add-in card will require the longer cable length. For R2216WTxxx System configurations with no SAS Expander, reference Tables 7 and 8 for cabling guidance

Table 8. 2U 8 x 2.5" (Drive Bay #2) – SAS / SATA Data Cable Guide (with no SAS Expander)



System Configuration	Drive Support	Cables for On-board Multi-port SATA Ports to Drive Bay #2	Cables for Mezzanine 12 Gb SAS ROC Module to Drive Bay #2	Cables for Mezzanine 6 Gb SAS ROC module to Drive Bay #2	Cables for 12 Gb SAS RAID PCIe* add-in card to Drive Bay #2	Cables for 6 Gb SAS RAID PCIe* add-in card to Drive Bay #2
Drive Bay #2 (no SAS Expander) R2216... R2224...	8 x 2.5"	Cable Connections: SATA Cntrl -> BP 0-3 730mm HD -- HD sSATA Cntrl -> BP 4-7 875mm HD -- HD From data above, select appropriate cable kits from <u>list below</u> : AXXCBL730HDHD (730mm Included in all 2.5" L6) AXXCBL875HDHD (875mm Included in R2224 L6)	Cable Connections: SAS Mezz -> BP 0-3 730mm HD -- HD SAS Mezz -> BP 4-7 875mm HD -- HD From data above, select appropriate cable kits from <u>list below</u> : AXXCBL730HDHD (730mm Included in all 2.5" L6) AXXCBL875HDHD (875mm Included in R2224 L6)	Cable Connections: SAS Mezz -> BP 0-3 730mm HD -- MS SAS Mezz -> BP 4-7 875mm HD -- MS From data above, select appropriate cable kits from <u>list below</u> : AXXCBL730HDMS AXXCBL875HDMS	From Riser #1: SAS PCIe -> BP 0-3 ** 650 or 730mm HD -- HD SAS PCIe -> BP 4-7 ** 730 or 800mm HD -- HD From Riser #2: SAS PCIe -> BP 0-3 ** 800 or 875mm HD -- HD SAS PCIe -> BP 4-7 ** 730 or 875mm HD -- HD From data above, select appropriate cable kits from <u>list below</u> : AXXCBL650HDHD AXXCBL730HDHD (2) 730mm Included in all 2.5" L6 AXXCBL800HDHD AXXCBL875HDHD (4) 875mm Included in R2224 L6)	From Riser #1: SAS PCIe -> BP 0-3 ** 650 or 730mm HD -- MS SAS PCIe -> BP 4-7 ** 730 or 800mm HD -- MS From Riser #2: SAS PCIe -> BP 0-3 ** 800 or 875mm HD -- MS SAS PCIe -> BP 4-7 ** 730 or 875mm HD -- MS From data above, select appropriate cable kits from <u>list below</u> : AXXCBL650HDMS AXXCBL730HDMS AXXCBL800HDMS AXXCBL875HDMS

** 1 or 2 cable lengths may be specified for a PCIe add-in card. Generally, if the cable connector of the add-in card is located on the back edge of the card, a shorter cable is specified. Cable connectors on the top edge or near the front of the add-in card will require the longer cable length. For R2224WTxxx System configurations with no SAS Expander, reference Tables 7, 8, and 9 for cable guidance for all three drive bay modules.

Table 9. 2U 8 x 2.5" (Drive Bay #3) – SAS / SATA Data Cable Guide (with no SAS Expander)

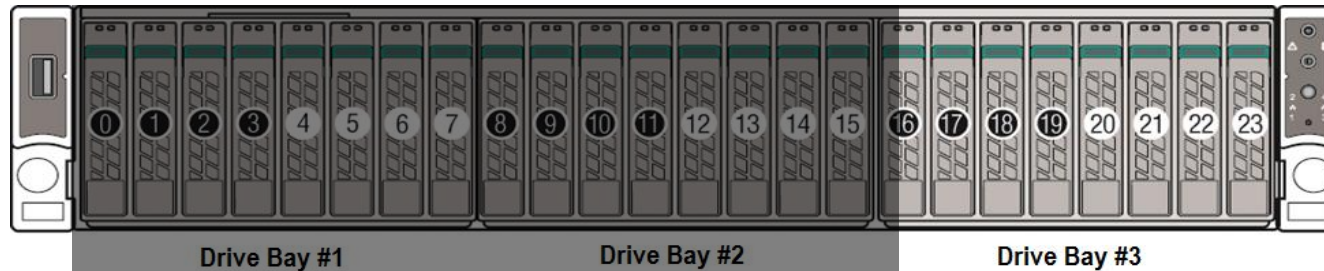



System Configuration	Drive Support	Cables for On-board Multi-port SATA Ports to Drive Bay #3	Cables for Mezzanine 12 Gb SAS ROC Module to Drive Bay #3	Cables for Mezzanine 6 Gb SAS ROC module to Drive Bay #3	Cables for 12 Gb SAS RAID PCIe* add-in card to Drive Bay #3	Cables for 6 Gb SAS RAID PCIe* add-in card to Drive Bay #3
Drive Bay #3 (no SAS Expander) R2224...	8 x 2.5"	<p>Cable Connections:</p> <p>SATA Cntrl -> BP 0-3 800mm HD -- HD</p> <p>sSATA Cntrl -> BP 4-7 730mm HD -- HD</p> <p>From data above, select appropriate cable kits from <u>list below</u>:</p> <p>AXXCBL730HDHD (2) 730mm cables Included in all 2.5" L6)</p> <p>AXXCBL800HDHD</p>	<p>Cable Connections:</p> <p>SAS Mezz -> BP 0-3 730mm HD -- HD</p> <p>SAS Mezz -> BP 4-7 730mm HD -- HD</p> <p>From data above, select appropriate cable kits from <u>list below</u>:</p> <p>AXXCBL730HDHD (2) 730mm cables Included in all 2.5" L6)</p>	<p>Cable Connections:</p> <p>SAS Mezz -> BP 0-3 730mm HD -- MS</p> <p>SAS Mezz -> BP 4-7 730mm HD -- MS</p> <p>From data above, select appropriate cable kits from <u>list below</u>:</p> <p>AXXCBL730HDMS</p>	<p>From Riser #1:</p> <p>SAS PCIe -> BP 0-3 ** 730 or 875mm HD -- HD</p> <p>SAS PCIe -> BP 4-7 ** 800 or 950mm HD -- HD</p> <p>From Riser #2:</p> <p>SAS PCIe -> BP 0-3 ** 730 or 875mm HD -- HD</p> <p>SAS PCIe -> BP 4-7 ** 650 or 800mm HD -- HD</p> <p>From data above, select appropriate cable kits from <u>list below</u>:</p> <p>AXXCBL650HDHD AXXCBL730HDHD (2) 730mm Included in all 2.5" L6 AXXCBL800HDHD AXXCBL875HDHD (4) 875mm Included in R2224 L6 AXXCBL950HDHD</p>	<p>From Riser #1:</p> <p>SAS PCIe -> BP 0-3 ** 730 or 875mm HD -- MS</p> <p>SAS PCIe -> BP 4-7 ** 800 or 950mm HD -- MS</p> <p>From Riser #2:</p> <p>SAS PCIe -> BP 0-3 ** 800 or 875mm HD -- MS</p> <p>SAS PCIe -> BP 4-7 ** 650 or 800mm HD -- MS</p> <p>From data above, select appropriate cable kits from <u>list below</u>:</p> <p>AXXCBL650HDMS AXXCBL730HDMS AXXCBL800HDMS AXXCBL875HDMS AXXCBL950HDMS</p>

** 1 or 2 cable lengths may be specified for a PCIe add-in card. Generally, if the cable connector of the add-in card is located on the back edge of the card, a shorter cable is specified. Cable connectors on the top edge or near the front of the add-in card will require the longer cable length.

4.2.5.2 2U 2.5" Front Mount Drive Configurations – SAS Data Cable Guide (with SAS Expander)

SAS drive configurations consisting of more than 8 drives may require the addition of a SAS Expander card. In the 2U 16x2.5" or 24x2.5" system configurations, a SAS expander can be mounted in the area directly behind the drive bays. Intel provides two SAS expander options to support these drive configurations:

Intel Product Code	Order Information	Product Description	Product Type
<p>iPC – RES3TV360</p>  <p>Intel® RAID Expander RES3TV360</p>	<p>MM# – 932894 UPC – 00735858287364 EAN – 5032037067102 MOQ - 5</p>	<ul style="list-style-type: none"> • SAS 3.0 12 Gb/s expander featuring 6Gbps data aggregation for 12Gbps data transfer with 6Gb/s devices • Internal mount mid-plane form factor • 36 internal ports supporting point-to-point 12, 6, and 3 Gb/s data transfer rates • RA 4-pin power connector • HD Mini-SAS 8643 Connectors <p>Kit includes: (1) SAS expander card; (1) 130mm Power cable; (1 set) Expander-to-backplane cables: (4) HD-HD 165mm, (1) HD-HD 300mm, (1) HD-HD 250mm; (3) Rubber Pads; mounting screws</p> <p>Required (sold separately)</p> <ul style="list-style-type: none"> • HD-HD 12 Gb/sec Raid Controller-to-Expander cables – See table section 0 • HD-MS 6 Gb/s RAID Controller-to-Expander cables – See table section 0 	<ul style="list-style-type: none"> • 2U Accessory Kit
<p>iPC – RES2CV360</p>  <p>Intel® RAID Expander RES2CV360</p>	<p>MM# – 918935 UPC – 00735858241168 EAN – 5032037035897 MOQ - 1</p>	<ul style="list-style-type: none"> • SAS 2.0 6 Gb/s expander • Internal mount mid-plane form factor • 36 Port 6Gb expander card with ports configurable for input or output • Power from 4-pin connector • Mini-SAS 8087 connectors <p>Kit includes: (1) 6 Gb/s SAS Expander card; (1) 130mm power cable; (3) rubber mounting pads; (1 set) 6 Gb Expander to 6 Gb backplane cables: (3) MS-MS 165mm, (2) MS-MS 185mm, (1) MS-MS 245mm (NOTE: included data cables not compatible in R2312WT... system)</p> <p>Required (sold separately): iPC – AXXCBLEXPDM5 - MS-HD 6Gb Expander to 12 Gb Backplane Data Cable kit, SAS Data Cables from 6 Gb SAS RAID PCIe/Mezz Card to expander. See Table 10.</p>	<ul style="list-style-type: none"> • 2U Accessory Kit

Note: The onboard SATA ports are not compatible with SAS Expander cards. The onboard SATA ports can only be cabled directly to a specified backplane.

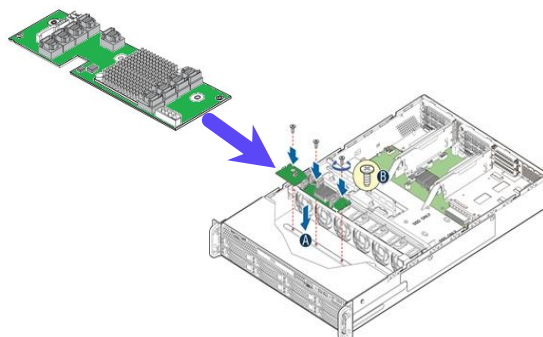

Table 10. 2U 2.5" Front Mount Drive Configurations with SAS Expander – SAS Data Cable Guide

Mezzanine 12Gb SAS ROC Module to 12 Gb SAS Expander	12Gb SAS RAID PCIe* add-in card to 12 Gb SAS Expander	Mezzanine 6 Gb SAS ROC Module to 12 Gb SAS Expander	6Gb SAS RAID PCIe* add-in card to 12 Gb SAS Expander	Mezzanine 6 Gb SAS ROC Module to 6 Gb SAS Expander	6Gb SAS RAID PCIe* add-in card to 6 Gb SAS Expander
<p>12 Gb SAS Expander RES3TV360 installed:</p> <p>SAS Mezz -> Exp 0-3 (G) 730mm HD -- HD</p> <p>SAS Mezz -> Exp 4-7 (H) 730mm HD -- HD</p> <p>From data above, select appropriate cable kits from list below:</p> <p>AXXCBL730HDHD (2) 730mm cables Included in all 2.5" L6)</p>	<p>12 Gb SAS Expander RES3TV360 installed:</p> <p>From Riser #1: SAS PCIe -> Exp 0-3 (G) 650mm HD -- HD SAS PCIe -> Exp 4-7 (H) 650mm HD -- HD</p> <p>From Riser #2: SAS PCIe -> Exp 0-3 (G) 730mm HD -- HD SAS PCIe -> Exp 4-7 (H) 730mm HD -- HD</p> <p>From data above, select appropriate cable kits from list below:</p> <p>AXXCBL650HDHD AXXCBL730HDHD (2) 730mm cables Included in all 2.5" L6)</p>	<p>12 Gb SAS Expander RES3TV360 installed:</p> <p>SAS Mezz -> Exp 0-3 (G) 730mm HD -- MS</p> <p>SAS Mezz -> Exp 4-7 (H) 730mm HD -- MS</p> <p>From data above, select appropriate cable kits from list below:</p> <p>AXXCBL730HDMS</p>	<p>12 Gb SAS Expander RES3TV360 installed:</p> <p>From Riser #1: SAS PCIe -> Exp 0-3 (G) 650mm HD --MS SAS PCIe -> Exp 4-7 (H) 650mm HD --MS</p> <p>From Riser #2: SAS PCIe -> Exp 0-3 (G) 730mm HD --MS SAS PCIe -> Exp 4-7 (H) 730mm HD -- MS</p> <p>From data above, select appropriate cable kits from list below:</p> <p>AXXCBL650HDMS AXXCBL730HDMS</p>	<p>6 Gb SAS Expander RES2CV360 installed:</p> <p>SAS Mezz -> Exp 0-3 (A) 730mm MS -- MS</p> <p>SAS Mezz -> Exp 4-7 (B) 730mm MS -- MS</p> <p>From data above, select appropriate cable kits from list below:</p> <p>AXXCBL730MSMS</p>	<p>6 Gb SAS Expander RES2CV360 installed:</p> <p>From Riser #1: SAS PCIe -> Exp 0-3 (G) 650mm MS --MS SAS PCIe -> Exp 4-7 (H) 650mm MS --MS</p> <p>From Riser #2: SAS PCIe -> Exp 0-3 (G) 730mm MS --MS SAS PCIe -> Exp 4-7 (H) 730mm MS -- MS</p> <p>From data above, select appropriate cable kits from list below:</p> <p>AXXCBL650MSMS AXXCBL730MSMS</p>
12 Gb SAS Expander to drive bays	12 Gb SAS Expander to drive bays	12 Gb SAS Expander to drive bays	12 Gb SAS Expander to drive bays	6 Gb SAS Expander to drive bays	6 Gb SAS Expander to drive bays
Use cables included in SAS Expander Kit	Use cables included in SAS Expander Kit	Use cables included in SAS Expander Kit	Use cables included in SAS Expander Kit	Cable Kit Required: iPC – AXXCBLEXPDMMS	Cable Kit Required: iPC – AXXCBLEXPDMMS

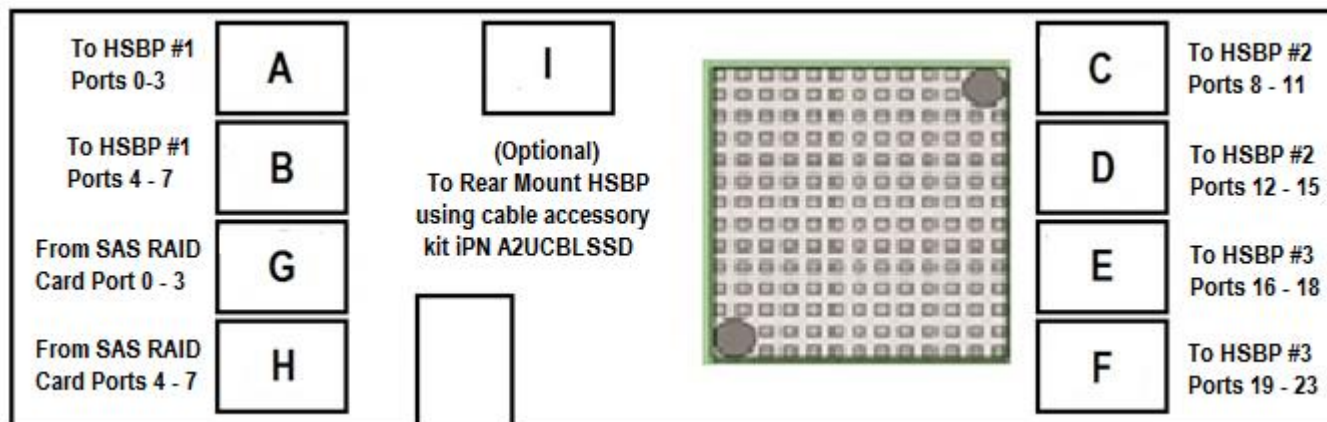

Figure 9. – 12Gb Internal 36-Port Intel® RAID Expander Card RES3TV360 - Connector Identification Block Diagram

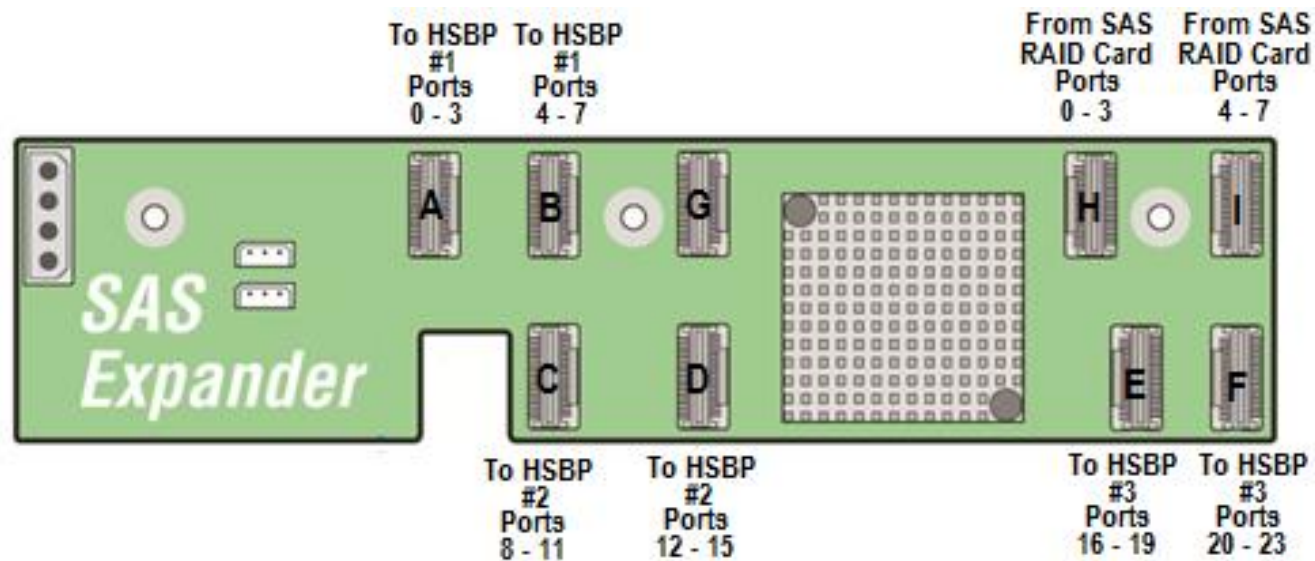





Figure 10. – 6Gb Internal 36-Port Intel® RAID Expander Card RES2CV360 - Connector Identification Block Diagram

4.3 Intel SAS / SATA Data Cable Kits

Each cable accessory kit referenced in this section will identify the connector type at each end of the cable using the following identifiers: **HR**, **HD**, and **MS**. The following table identifies the three cable connector types and their identifiers.

	HR = Right Angle SFF-8643 Mini SAS HD Connector
	HD = Straight SFF-8643 Mini SAS HD Connector
	MS = Straight SFF-8087 Mini SAS Connector (compatible with 6Gb/sec SAS controllers and expanders)

Cable Kit Product Code Decoder

Example – iPC **AXXCBL950HDMS**

AXXCBL – identifies an accessory cable kit

950 – identifies the length of the cable

HD – identifies that one cable connector supports an SFF-8643 type connector

MS – identifies that one cable connector supports an SFF-8087 type connector

Table 11. Storage Data Cable Kit Description and Order Information







Image	Order Information	Description
	iPC – AXXCBL950HDHD MM – 936122 UPC – 00735858286596 EAN – 5032037066495 MOQ – 1	950 mm long, cable kit (2 cables included) straight SFF8643 to straight SFF8643 Used in multiple systems as spare and/or accessory (1304, 2308, 2312)
	iPC – AXXCBL875HDHD MM – 936123 UPC – 00735858284769 EAN – 5032037065054 MOQ – 1	875 mm long, cable kit (2 cables included) straight SFF8643 to straight SFF8643 Used in multiple systems as spare and/or accessory (1304, 1208, 2208, 2312)
	iPC – AXXCBL800HDHD MM – 937312 UPC – 00735858286015 EAN – 5032037066006 MOQ – 1	800 mm long, cable kit (2 cables included) straight SFF8643 to straight SFF8643 Used in multiple systems as spare and/or accessory (1203, 1208, 2308, 2312)
	iPC – AXXCBL730HDHD MM – 936178 UPC – 00735858284745 EAN – 5032037065030 MOQ – 1	730 mm long, cable kit (2 cables included) straight SFF8643 to straight SFF8643 Used in multiple systems as spare and/or accessory (1208, 2208)
	iPC – AXXCBL650HDHD MM – 937129 UPC – 00735858284752 EAN – 5032037065047 MOQ – 1	650 mm long, cable kit (2 cables included) straight SFF8643 to straight SFF8643 Used as accessory when installing 12G ROC module in 1208 for optimal cabling. (longer cable may be used)
	iPC – AXXCBL1UHRHD MM – 937311 UPC – 00735858287401 EAN – 5032037067140 MOQ – 1	Combo cable kit, contains 2 cables. One of each of the following: 730mm (AXXCBL800HRHD), 800mm right angle SFF8643 to straight SFF8643, Spare cables used in 1U WT systems to connect to onboard SATA ports.











Image	Order Information	Description
	<p>iPC – AXXCBL950HDMS MM – 937131 UPC – 00735858286633 EAN – 5032037066532 MOQ – 1</p>	<p>950 mm long, cable kit (2 cables included) straight SFF8643 to straight SFF8087</p> <p>Required in WT 2U systems with 6G SAS ROC module or 6G SAS RAID cards. (1304 with HBA, 2308 and 2312 HBA/module)</p>
	<p>iPC – AXXCBL875HDMS MM – 937130 UPC – 00735858286626 EAN – 5032037066525 MOQ – 1</p>	<p>875 mm long, cable kit (2 cables included) straight SFF8643 to straight SFF8087</p> <p>Required in WT 2U systems with 6G SAS ROC module or 6G SAS RAID cards. (1304 and 1208 with HBA, 2216,2224,2312 with HBA/module)</p>
	<p>iPC – AXXCBL800HDMS MM – 937309 UPC – 00735858286084 EAN – 5032037066075 MOQ – 1</p>	<p>800 mm long, cable kit (2 cables included) straight SFF8643 to straight SFF8087</p> <p>Required in WT 2U systems with 6G SAS ROC module or 6G SAS RAID cards. (1304 and 1208 with module, 2308 and 2312 HBA/module)</p>
	<p>iPC – AXXCBL730HDMS MM – 927238 UPC – 00735858266970 EAN – 5032037053648 MOQ – 5</p>	<p>730 mm long, cable kit (2 cables included) straight SFF8643 to straight SFF8087</p> <p>Required in WT 2U systems with 6G SAS ROC module or 6G SAS HBA cards. (1208 with HBA, 2208 with HBA/module)</p>
	<p>iPC – AXXCBL650HDMS MM – 927237 UPC – 00735858266963 EAN – 5032037053631 MOQ – 5</p>	<p>650 mm long, cable kit (2 cables included) straight SFF8643 to straight SFF8087</p> <p>Used as accessory when installing 6Gb ROC module in 1208 for optimal cabling. (longer cable may be used)</p>

Image	Order Information	Description
	iPC – AXXCBLEXPDM5 MM – 937127 UPC – 00735858284776 EAN – 5032037065061 MOQ – 1	6 Gb Expander to 12 Gb Backplane cable kit 6Gb MS – to – 12Gb HD (3) 165 mm , (1) 185 mm , (1) 245 mm , (1) 300 mm straight SFF8643 to straight SFF8087
	iPC – AXXCBL650MSMS MM – 918376 UPC – 00735858224444 EAN – 5032037019910 MOQ – 5	650 mm long, cable kit (2 cables included) straight SFF8087 to straight SFF8087 Required in WT 2U systems with 6Gb SAS ROC module or 6Gb SAS HBA cards. (1208 with HBA, 2208 with HBA/module) and 6 Gb Expander card
	iPC – AXXCBL730MSMS MM – 921049 UPC – 00735858245340 EAN – 5032037039864 MOQ – 1	730 mm long, cable kit (2 cables included) straight SFF8087 to straight SFF8087 Required in WT 2U systems with 6Gb SAS ROC module or 6Gb SAS HBA cards. (1208 with HBA, 2208 with HBA/module) and 6 Gb Expander card
	iPC – AXXCBL880SATA MM – 922988 UPC – 00735858250290 EAN – 5032037044806 MOQ – 10	Spare SATA ODD Data cable for rack chassis family – 880mm long Included with ODD accessories
	iPC – A2UCBLSSD MM# – 937328 UPC – 00735858287005 EAN – 5032037066747 MOQ - 1	2U Cable kit accessory This kit includes cables necessary to provide simultaneous support for up to two internal air duct mounted SATA SSDs + rear drive bay (iPC – A2UREARHSDK) Kit includes: (1) Power Cable – Connectors to support rear drive bay and 2 internal mount SSDs (No CD/DVD Drive support) (1) fan out multiport SATA Data cable – Cable connectors include (1) HD mini-SAS SFF8643 + (4) 7-pin SATA + (1) SGPIO

5 Intel 1U / 2U System Configuration Options

The following sections identify available accessory kits supported within the Intel® S2600WT product family.

5.1 1U 8x2.5" Combo PCIe* SFF (NVMe) SSD / SAS Backplane – Intel® Accessory Kit A1U44X25NVMEDK

- The 8x2.5" combo backplane kit is capable of supporting a combination of both SAS devices and up to four PCIe* SFF (Small Form Factor) (NVMe) SSD drives
- All eight drive connectors are capable of supporting a SAS device, but only four include SFF8639 connectors that can support PCIe* SFF (NVMe) SSDs
- This kit is only supported in dual processor configurations

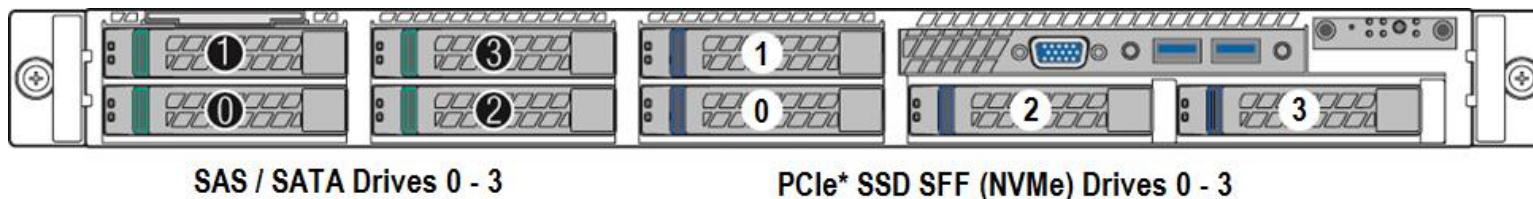

Intel Product Code	Order Information	Product Description	Product Type
<p>iPC – A1U44X25NVMEDK</p> 	<p>MM# – 936251 UPC – 00735858288873 EAN – 5032037068154 MOQ – 1</p>	<p>1U 8x2.5" Combo PCIe* SFF (NVMe) SSD / SAS Backplane Kit</p> <p>Kit IncludesL</p> <ul style="list-style-type: none"> (1) Combo Hot Swap Backplane PCBA (4) SAS / SATA Hot Swap Drive Carriers (Green Latch) (4) PCIe* SFF SSD (NVMe) Hot Swap Drive Carriers (Blue Latch) (2) Dual PCIe* Port Cables (1) PCIe x16 Add-in card (1) Installation Guide <p>Required (Sold Separately): SAS / SATA Data cables - See section 5.1.1</p>	<ul style="list-style-type: none"> • 1U Accessory Kit

See the Intel® Server System R1000WT Technical Product Specification for additional information.

5.1.1 1U 8x2.5" – Intel® Accessory Kit A1U44X25NVMEDK Cable Guide

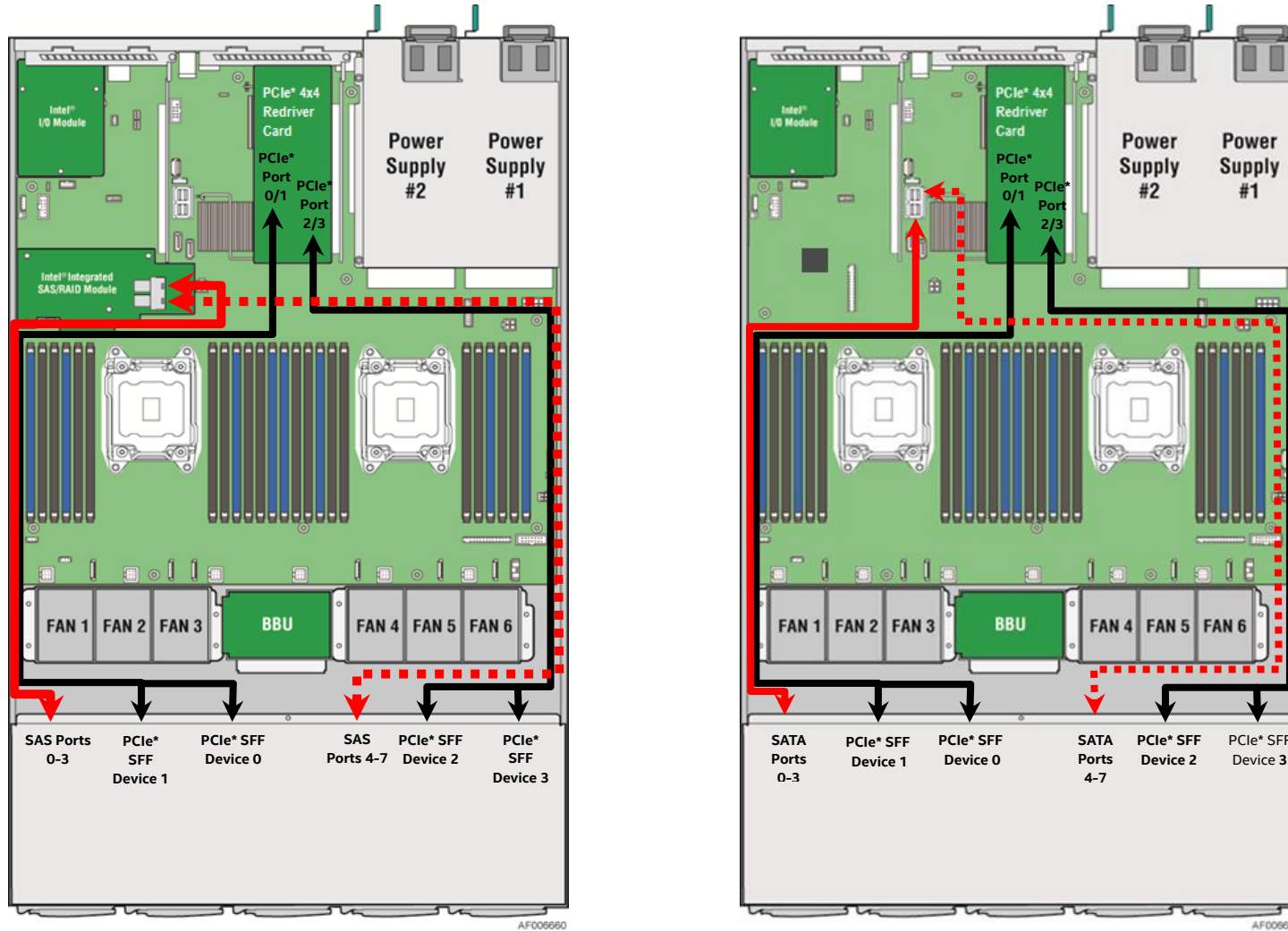

Figure 11. 1U Combo Backplane (iPC – A1U44X25NVMEDK) Cable Routing

Table 12. 1U 8x2.5" Combo Backplane SAS/SATA Cable Guide

System Configuration	Drive Support	Cables for On-board Multi-port SATA Ports to Backplane	Cables for Mezzanine 12 Gb SAS ROC Module to Backplane	Cables for Mezzanine 6 Gb SAS RAID module to Backplane	Cables for 12 Gb SAS RAID PCIe* add-in card to Backplane	Cables for 6 Gb SAS RAID PCIe* add-in card to Backplane
<p>R1208WTxxx R1208WTTGSR R1208WT2GSR</p> <p>with A1U44X25NVMEDK</p>	<p>A1U44X25NVMEDK Accessory kit Option</p> <p>8 x 2.5" Combo SAS / SATA + PCIe* SSD SFF (NVMe) 12 Gb SAS capable</p> <p>PCIe* cables included in accessory kit. For SAS/SATA support see the following options</p>	<p>730 mm HR --- HD Connect cable to: SATA -> BP 0-3</p> <p>and / or</p> <p>800 mm HR --- HD Connect cable to: sSATA -> BP 4-7</p> <p>Cables Included with system SKUs.</p> <p>Cable kit required for building block integration: AXXCBL1UHRHD</p> <p>Use PCIe* cables included with Combo backplane kit for PCIe* SSD / NVMe drive support</p>	<p>650 mm HD --- HD Connect cable to: SAS Mezz -> BP 0-3</p> <p>and/or</p> <p>800 mm HD --- HD Connect cable to: SAS Mezz -> BP 4-7</p> <p>Cable Kits Required: AXXCBL650HDHD and / or AXXCBL800HDHD</p> <p>Use PCIe* cables included with Combo backplane kit for PCIe* SSD / NVMe drive support</p>	<p>650 mm HD --- MS Connect cable to: SAS Mezz -> BP 0-3</p> <p>and/or</p> <p>800 mm HD --- MS Connect cable to: SAS Mezz -> BP 4-7</p> <p>Cable Kits Required: AXXCBL650HDMS and / or AXXCBL800HDMS</p> <p>Use PCIe* cables included with Combo backplane kit for PCIe* SSD / NVMe drive support</p>	<p>From Riser #1</p> <p>730 mm HD --- HD Connect cable to: SAS PCIe -> BP 0-3</p> <p>and/or</p> <p>875 mm HD --- HD Connect cable to: SAS PCIe -> BP 4-7</p> <p>Cable Kits Required: AXXCBL730HDHD and / or AXXCBL875HDHD</p> <p>Use PCIe* cables included with Combo backplane kit for PCIe* SSD / NVMe drive support</p>	<p>From Riser #1</p> <p>730 mm HD --- MS Connect cable to: SAS PCIe -> BP 0-3</p> <p>and/or</p> <p>875 mm HD --- MS Connect cable to: SAS PCIe -> BP 4-7</p> <p>Cable Kits Required: AXXCBL730HDMS and / or AXXCBL875HDMS</p> <p>Use PCIe* cables included with Combo backplane kit for PCIe* SSD / NVMe drive support</p>

5.2 2U 8x2.5" Combo PCIe* SFF (NVMe) SSD / SAS Backplane – Intel® Accessory Kit A2U44X25NVMEDK

- The 8x2.5" combo backplane kit is capable of supporting a combination of both SAS devices and up to four PCIe* SFF (Small Form Factor) (NVMe) SSD drives
- All eight drive connectors are capable of supporting a SAS device, but only four include SFF8639 connectors that can support PCIe* SFF (NVMe) SSDs
- The PCIe* x16 interface add-in card **MUST** be installed in a x16 riser card (included), and is only supported in the Riser #2 slot of the server board.
- This kit is only supported in dual processor configurations
- The 2U system is limited to supporting only one combo backplane kit in addition to one or two other backplane options
- The combo backplane module can only be supported in the first (left) drive bay when no other backplane module is installed
- Due to thermal and power limits associated with 16 x 2.5" and 24 x 2.5" front drive configurations, the combo backplane module can only be supported in the second (middle) drive bay

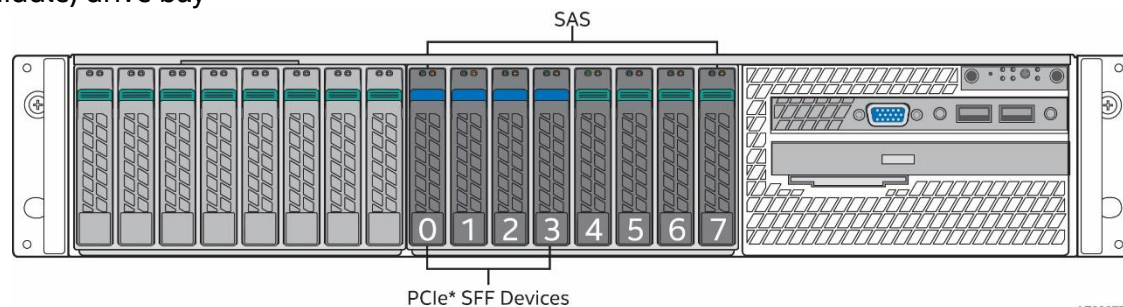

Intel Product Code	Order Information	Product Description	Product Type
iPC – A2U44X25NVMEDK 	MM# – 936253 UPC – 00735858288880 EAN – 5032037068161 MOQ – 1	2U 8x2.5" Combo PCIe* SFF (NVMe) SSD / SAS Backplane Kit Kit Includes: (1) 8x2.5" Drive Bay Assembly with backplane (4) SAS / SATA Hot Swap Drive Carriers (Green Latch) (4) PCIe* SFF SSD (NVMe) Hot Swap Drive Carriers (Blue Latch) (2) Dual PCIe* Port Cables (1) PCIe x16 Add-in card (1) 2-slot PCIe Riser card PCBA and mounting screws (1) I2C jumper cable (used in dual backplane configurations) (1) Installation Guide	<ul style="list-style-type: none"> • 2U Accessory Kit
		Required (Sold Separately): SAS / SATA Data cables - See sections 5.2.1& 5.2.2	

See the Intel® Server System R2000WT Technical Product Specification for additional information.

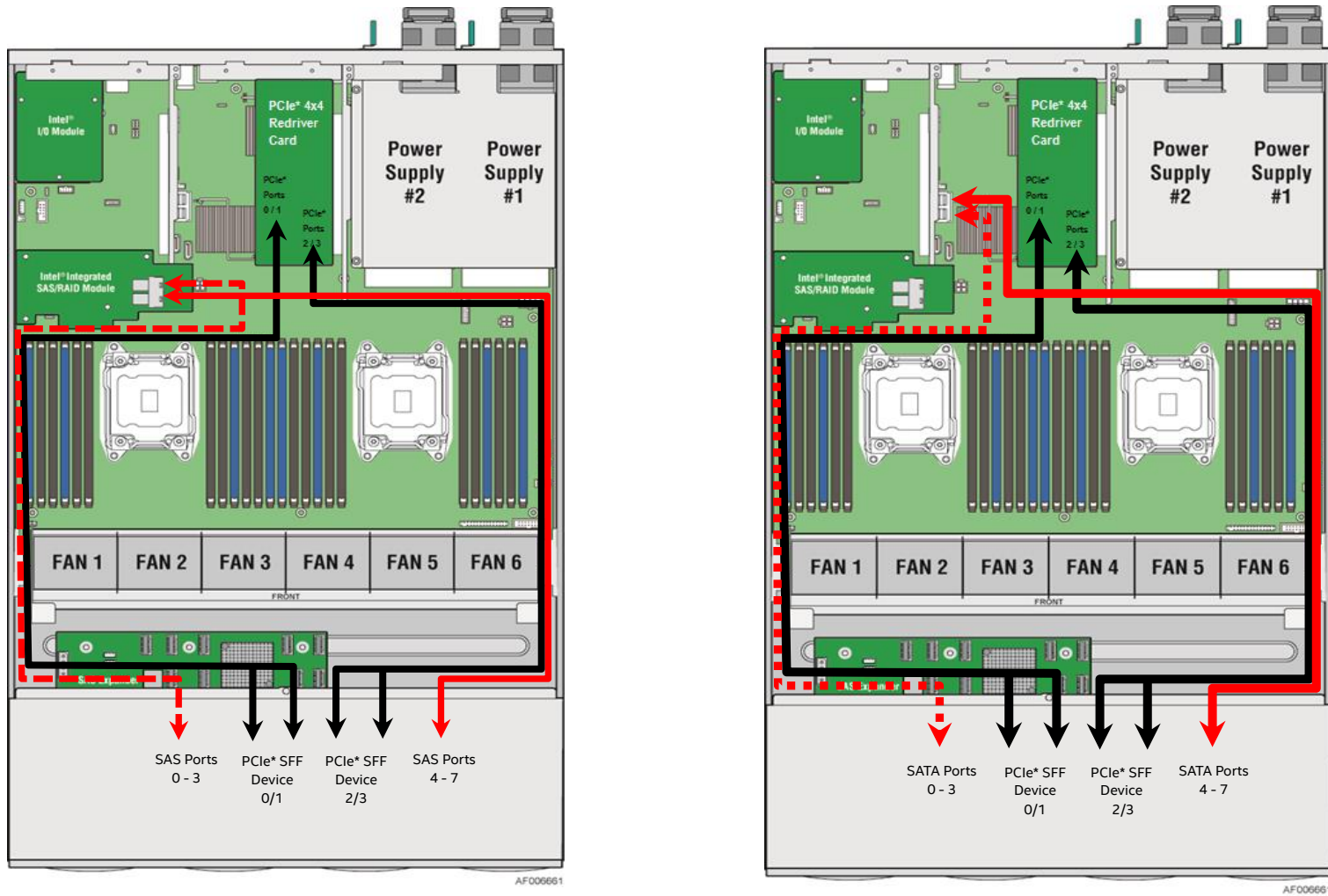

Figure 12. 2U Combo Backplane (iPC – A2U44X25NVMEDK) Cable Routing

5.2.1 2U 8x2.5" – Intel® Accessory Kit A2U44X25NVMEDK SAS/SATA Cable Guide

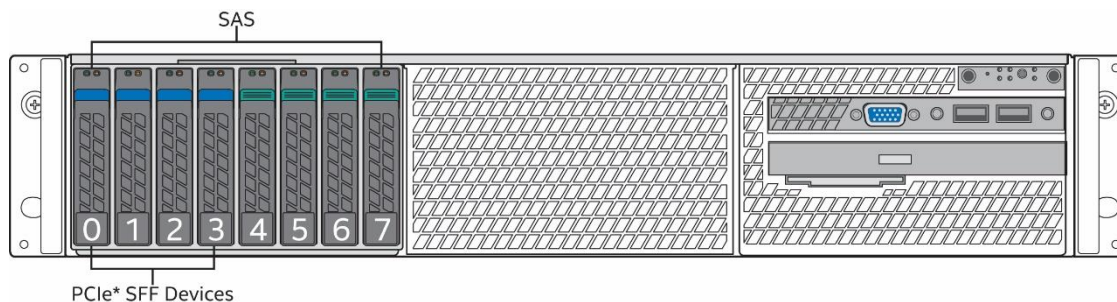

Figure 13. Combo Backplane Module Placement – 8 x 2.5" front drive configurations

System Configuration	Drive Bay #1	Cables for On-board Multi-port SATA Ports to Backplane	Cables for Mezzanine 12 Gb SAS ROC Module to Backplane	Cables for Mezzanine 6 Gb SAS RAID module to Backplane	Cables for 12 Gb SAS RAID PCIe* add-in card to Backplane	Cables for 6 Gb SAS RAID PCIe* add-in card to Backplane
<p>R2208WT...</p> <p>Drive Bay #1 populated</p>	<p>8 x 2.5" Combo SAS / SATA + PCIe* SSD SFF (NVMe) iPC A2U44X25NVMEDK</p> <p>PCIe* cables included in accessory kit. For SAS/SATA support see the following options</p>	<p>730 mm HD --- HD Connect cable to: SATA -> BP 0-3 Included w/system SKUs</p> <p>and / or</p> <p>730 mm HD --- HD Connect cable to: sSATA -> BP 4-7 Included w/system SKUs</p> <p>Cable kit required for building block integration: (2) AXXCBL730HDHD</p> <p>Use PCIe* cables included with Combo backplane kit for PCIe* SSD SFF / NVMe drive support</p>	<p>730 mm HD --- HD Connect cable to: SAS Mezz -> BP 0-3 Included w/system SKUs</p> <p>and/or</p> <p>730 mm HD --- HD Connect cable to: SAS Mezz -> BP 4-7 Included w/system SKUs</p> <p>Cable kit required for building block integration: (2) AXXCBL730HDHD</p> <p>Use PCIe* cables included with Combo backplane kit for PCIe* SSD SFF / NVMe drive support</p>	<p>730 mm HD --- MS Connect cable to: SAS Mezz -> BP 0-3</p> <p>and/or</p> <p>730 mm HD --- MS Connect cable to: SAS Mezz -> BP 4-7</p> <p>Cable Kits Required: (1 or 2) AXXCBL730HDMS</p> <p>Use PCIe* cables included with Combo backplane kit for PCIe* SSD SFF / NVMe drive support</p>	<p>From Riser #1</p> <p>730 mm HD --- HD Connect cable to: SAS PCIe -> BP 0-3</p> <p>and/or</p> <p>730 mm HD --- HD Connect cable to: SAS PCIe -> BP 4-7</p> <p>Cable Kits Required: (1 or 2) AXXCBL730HDHD</p> <p>Use PCIe* cables included with Combo backplane kit for PCIe* SSD SFF / NVMe drive support</p>	<p>From Riser #1</p> <p>730 mm HD --- MS Connect cable to: SAS PCIe -> BP 0-3</p> <p>and/or</p> <p>730 mm HD --- MS Connect cable to: SAS PCIe -> BP 4-7</p> <p>Cable Kits Required: (1 or 2) AXXCBL730HDMS</p> <p>Use PCIe* cables included with Combo backplane kit for PCIe* SSD SFF / NVMe drive support</p>

5.2.2 2U 16x2.5" / 24x2.5" — Intel® Accessory Kit A2U44X25NVMEDK SAS / SATA Cable Guide

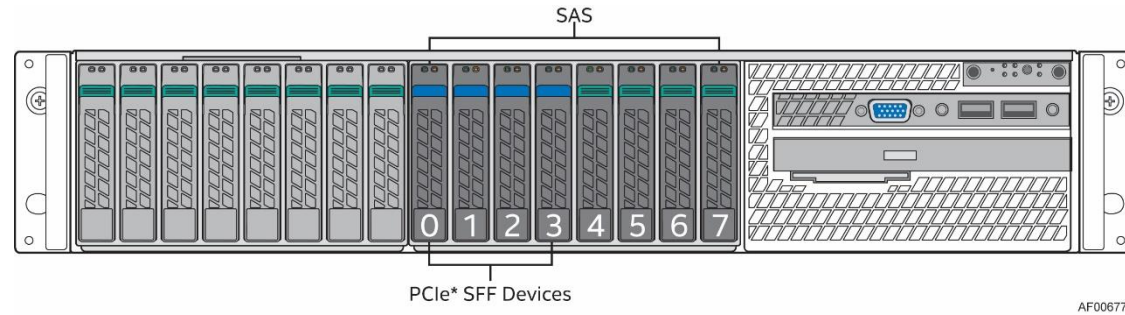



Figure 14. Combo Backplane Module Placement - 16 x 2.5" and 24 x 2.5" front drive configurations

System Configuration	Cables for Drive Bay #1	Drive Bay #2 Backplane Type	Cables for Mezzanine 12 Gb SAS ROC Module to Drive Bay #2	Cables for Mezzanine 6 Gb SAS RAID module to Drive Bay #2	Cables for 12 Gb SAS RAID PCIe* add-in card to Drive Bay #2	Cables for 6 Gb SAS RAID PCIe* add-in card to Drive Bay #2
<p>R2216WT... R2224WT...</p>	See section 5.2.1	<p>8 x 2.5" Combo SAS / SATA + PCIe* SSD SFF (NVMe) iPC A2U44X25NVMEDK</p> <p>PCIe* cables included in accessory kit. For SAS/SATA support see the following options</p>	<p>730mm HD --- HD Connect cable to: SAS Mezz -> BP 0-3</p> <p>and/or</p> <p>800mm HD --- HD Connect cable to: SAS Mezz -> BP 4-7</p> <p>One or both cable kits for building block integration: (1) AXXCBL730HDHD (1) AXXCBL800HDHD</p> <p>Use PCIe* cables included with Combo backplane kit for PCIe* SSD / NVMe drive support</p>	<p>730mm HD --- MS Connect cable to: SAS Mezz -> BP 0-3</p> <p>and/or</p> <p>800mm HD --- MS Connect cable to: SAS Mezz -> BP 4-7</p> <p>One or both cable kits for building block integration: (1) AXXCBL730HDMS (1) AXXCBL800HDMS</p> <p>Use PCIe* cables included with Combo backplane kit for PCIe* SSD / NVMe drive support</p>	<p>From Riser #1</p> <p>730 mm HD --- HD Connect cable to: SAS PCIe -> BP 0-3</p> <p>and/or</p> <p>800 mm HD --- HD Connect cable to: SAS PCIe -> BP 4-7</p> <p>One or both cable kits for building block integration: (1) AXXCBL730HDHD (1) AXXCBL800HDHD</p> <p>Use PCIe* cables included with Combo backplane kit for PCIe* SSD SFF / NVMe drive support</p>	<p>From Riser #1</p> <p>730 mm HD --- MS Connect cable to: SAS PCIe -> BP 0-3</p> <p>and/or</p> <p>800 mm HD --- MS Connect cable to: SAS PCIe -> BP 4-7</p> <p>One or both cable kits for building block integration: (1) AXXCBL730HDMS (1) AXXCBL800HDMS</p> <p>Use PCIe* cables included with Combo backplane kit for PCIe* SSD SFF / NVMe drive support</p>

5.3 2U 8x2.5" Combo PCIe x8 SFF (NVMe) SSD / SAS Backplane – Intel® Accessory Kit A2U44X25NVMEDK2

- This 8x2.5" combo backplane kit is capable of supporting a combination of both SAS devices and up to four PCIe* SFF (Small Form Factor) (NVMe) SSD drives and eight PCIe* SFF (Small Form Factor) (NVMe) SSD drives possible with the of A2U44X25NVMEDK2 kits.
- All eight drive connectors are capable of supporting a SAS device, but only four include SFF8639 connectors that can support PCIe* SFF (NVMe) SSDs
- The Intel® PCI Express 8-Lane add in card included in this kit has 4-Port Fan-Out Switch which is compatible with standard PCIe SIG x8 or x16 PCIe slots
- The Kit comes with both full height and low profile mounting brackets
- To support 8 NVMe drives there would be 4 NVMe in the first bay and 4 NVMe in the 2nd bay
- This kit is only supported in dual processor configurations
- The combo backplane module can be supported in the first (left) drive bay when no other backplane module is installed

Intel Product Code	Order Information	Product Description	Product Type
<p>iPC – A2U44X25NVMEDK2</p> 	<p>MM# – 947924 UPC – 00735858315555 EAN – 5032037086554 MOQ – 1</p>	<p>2U 8x2.5" Combo PCIe x8 SFF (NVMe) SSD / SAS Backplane</p> <p>Kit Includes:</p> <ul style="list-style-type: none"> (1) 8x2.5" Drive Bay Assembly with backplane (4) SAS / SATA Hot Swap Drive Carriers (Green Latch) (4) PCIe* SFF SSD (NVMe) Hot Swap Drive Carriers (Blue Latch) (2) Dualiport PCIe* SFF (NVMe) Device Cables (1) PCIe x8, 4-Port switch Add-In Card (1) I2C jumper cable (used backplane to backplane) (1) Installation Guide <p>Required (Sold Separately):</p> <p>SAS / SATA Data cables - See sections 5.2.1& 5.2.2</p>	<ul style="list-style-type: none"> • 2U Accessory Kit

Note: Cable connections identified in the following cable routing diagrams can be applied to any combo backplane assembly installed. However, cable routing may differ depending on which riser card the x8 PCIe* Retimer card is installed.

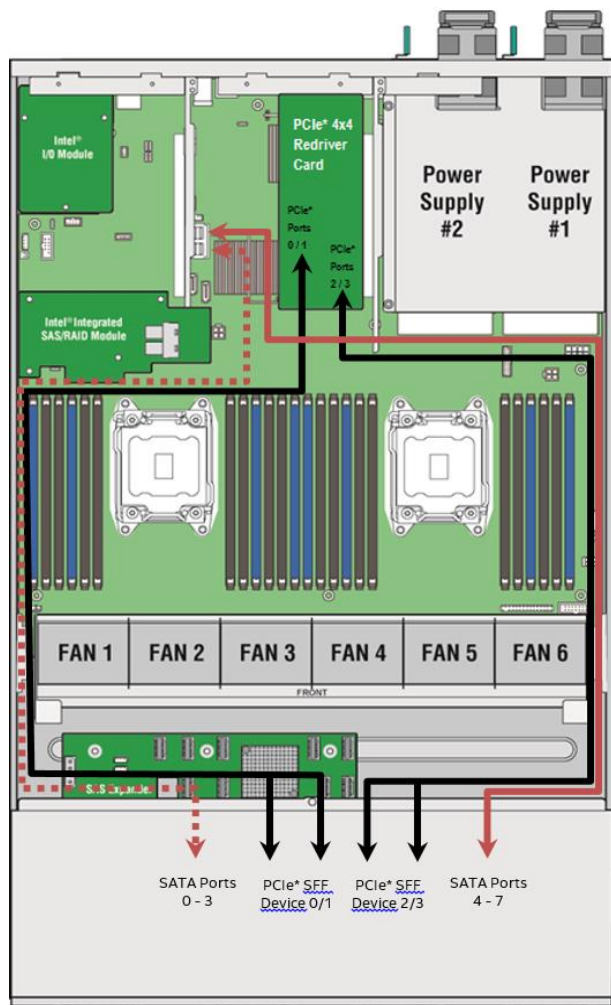

Combo Backplane Cable Routing – PCIe* SFF (NVMe) + SAS

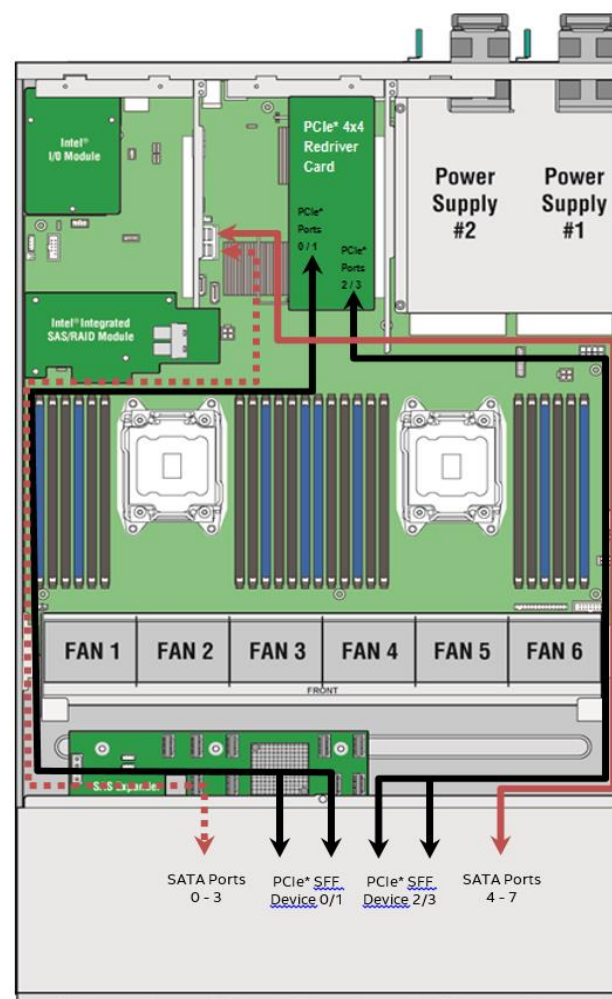

Combo Backplane Cable Routing - PCIe* SFF (NVMe) + SATA

5.3.1 2U Chassis Drive Bay Identification

5.3.1.1 Accessory Kit Integration and Usage Requirements

The 2U system is limited to supporting up to two combo backplane assemblies in addition to one or two other backplane options.

- The combo backplane assembly can only be supported in the first (left) drive bay when no other backplane module is installed.

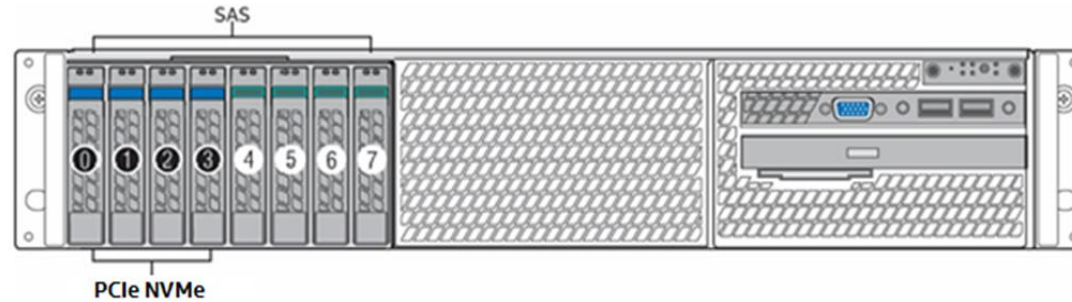

Combo Backplane Module Placement – 8 x 2.5" front drive configurations

- In 16 drive configurations, the combo backplane assemblies are supported in the first two drive bays of the 2U chassis.

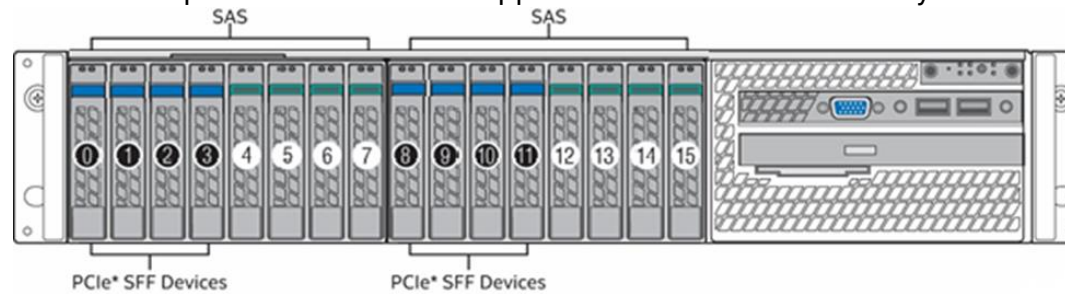

Combo Backplane Module Placement - 16 x 2.5" front drive configurations

- In a 24 drive configuration, the combo backplane assemblies are only supported in the first two drive bays of the chassis.

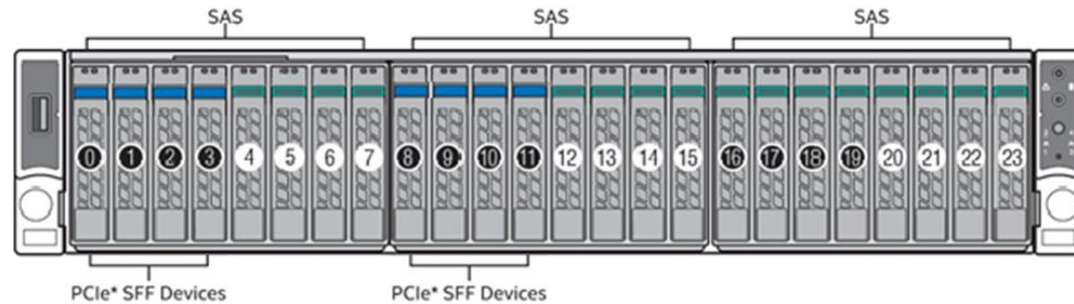

Combo Backplane Module Placement - 24 x 2.5" front drive configurations



- The front side of the backplane includes eight hot swap drive interface connectors. All eight connectors can support SAS (or SATA) drives, but only the first four are capable of supporting PCIe* SFF (NVMe) SSDs.
- The x8 PCIe* Switch Add-in Card can be supported in the following PCIe Riser Card locations:
- PCIe Riser Card #1 – Top and Bottom PCIe add-in card slots only
- PCIe Riser Card #2 – Any available PCIe add-in card slot
- PCIe Riser Card #3** (If installed) – Not supported

Note: With the exception of the top PCIe add-in slot on Riser #1, all PCIe add-in card slots identified above require that the system have 2 processors installed

5.4 2U Rear Mount Hot Swap Drive Bay Accessory Kit – iPC A2UREARHSDK

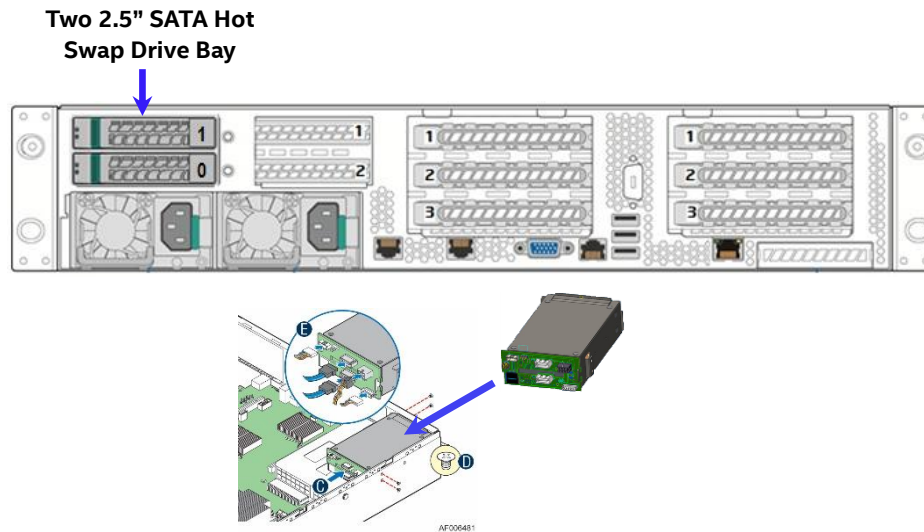
The 2U product family provides the option to support two 2.5" 6 Gb/sec hot swap SSDs installed to a modular drive bay mounted in the back of the system.



Intel Product Code	Order Information	Product Description	Product Type
<p>iPC - A2UREARHSDK</p> 	<p>MM - 934976 UPC - 735858283298 EAN - 5032037064354 MOQ - 1</p>	<p>2U Rear Mount Hot Swap Drive Bay Accessory Kit</p> <p>Kit Includes:</p> <ul style="list-style-type: none"> (1) Drive Bay Assembly and mounting hardware (2) 2.5" Hot Swap Drive Carriers (2) SATA Data Cables (1) Power Cable (1) I2C Cable (1) SGPIO cable 	<ul style="list-style-type: none"> • 2U Accessory Kit System and Building Block
<p>iPC - A2UCBLSSD</p> 	<p>MM# - 937328 UPC - 735858287005 EAN - 5032037066747 MOQ - 1</p>	<p>2U Fixed Mount SSD + Rear Drive Bay Cable Kit</p> <p>This kit includes cables to provide simultaneous support for up to two internal fixed mount SATA SSDs + rear drive bay</p> <p>Kit includes:</p> <ul style="list-style-type: none"> (1) Power Cable - Connectors to support rear drive bay and 2 internal mount SSDs (No CD/DVD Drive support) (1) Fan out multiport SATA Data cable - Cable connectors include (1) HD mini-SAS SFF8643 + (4) 7-pin SATA + (1) SGPIO 	<ul style="list-style-type: none"> • 2U Cable kit accessory

5.5 2U 8x3.5" Front Mount Hot Swap Backplane Assembly - iPC A2U8X35S3HSDK

8x3.5" SAS/SATA Front Mount Hot-Swap Drive Bay Module option for 2U Building Block Chassis iPC – R2000WTxxx.

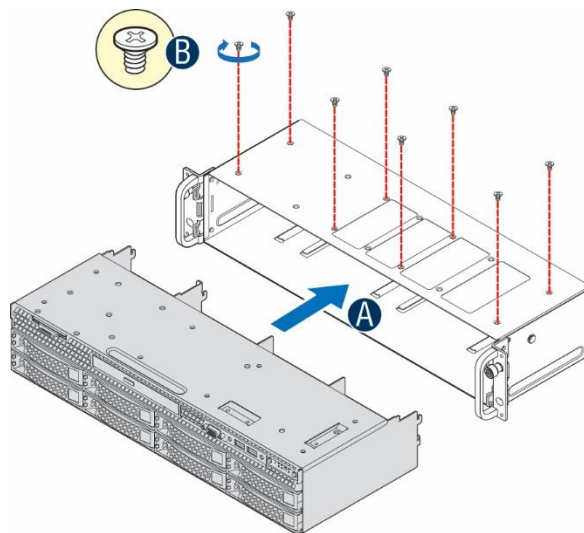

Intel Product Code	Order Information	Product Description	Product Type
<p>iPC – A2U8X35S3HSDK</p> 	<p>MM# – 936191 UPC – 00735858288781 EAN – 5032037068062 MOQ – 5</p>	<p>2U 8x3.5" Front Mount Hot Swap Backplane Assembly</p> <p>Kit Includes:</p> <ul style="list-style-type: none"> (1) Drive Bay Assembly Module (1) 8x3.5" hot swap backplane (8) 3.5" drive carriers + drive blanks (1) 175mm I2C Cable (1) 500mm ODD/SSD Power Cable (1) Chassis mounting clip (1 set) mounting hardware <p>Required (Sold Separately): SAS / SATA Data Cables. See section 4.2.3</p>	<ul style="list-style-type: none"> • 2U Building Block Accessory Kit

See the Intel® Server System R2000WT product family System Integration and Service Guide for complete kit installation instructions.

5.6 2U 8x2.5" Drive Bay Module Options

2U system configurations that include support for 2.5" front mount storage devices can support up to three 8x2.5" drive bay modules. Intel makes available different types of 8x2.5" drive bay modules and can support from 1 to 3 of the same module or a mix of different modules. Only the PCIe* SSD (NVMe) compatible module (iPC – A2U44X25NVMEDK) has the limitation of only supporting one of these modules in combination with other backplane modules in the system.

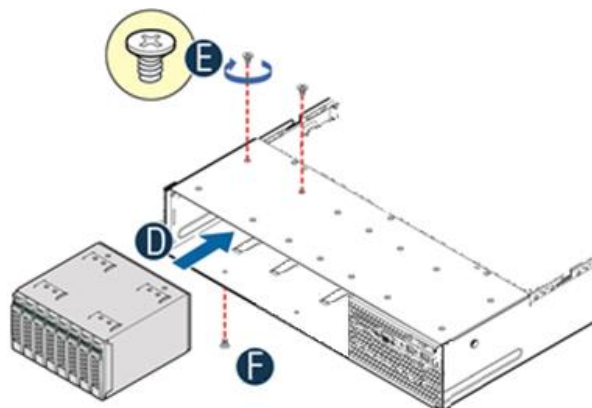

Figure 15. R2208WT and R2216WT based system with Front I/O Module Bay Assembly

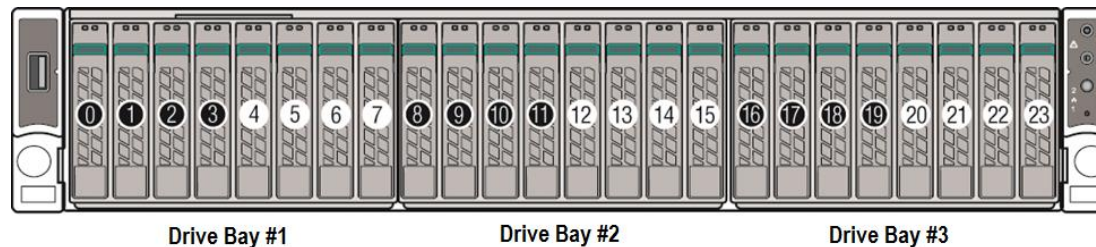



Figure 16. 2U 2.5" Drive Bay Numbering

Drive numbering in the illustrations above is for general reference only. Actual drive numbering will be dependent on SAS / SATA controller configuration and how they are cabled to the backplane. Each drive bay will include a single backplane. Each backplane will include a multi-port data connector for each set of four drives. Ex) for an 8 drive configuration, the backplane will include 2 four port data connectors. In the illustration above, drives showing a common Drive ID label color share a common data connector on the backside of the given backplane.

R2208WT (8x2.5" – 1 drive bay) and **R2216WT** (16x2.5" – 2 drive bays) system configurations utilize the same front I/O module bay assembly containing the System Control Panel and Front I/O Panel (as shown in Figure 9). When upgrading a R2208WT based system to an R2216WT based system, all that is needed is the removal of the Bay #2 face plate to insert the new drive bay, and adding the required data cables. No other chassis changes or additions are required.

Available SAS / SATA 8x25" accessory kits include the following.

Intel Product Code	Order Information	Product Description	Product Type
<p>iPC – A2U8X25S3HSDK</p> 	<p>MM# – 935066 UPC – 00735858288767 EAN – 5032037068048 MOQ – 1</p>	<p>8x2.5" SAS/SATA Front Mount Hot Swap Drive Bay Module for all 2U 2.5" systems</p> <p>Kit Includes:</p> <ul style="list-style-type: none"> (1) Drive Bay Assembly Module (1) 8x2.5" hot swap backplane (8) 2.5" drive carriers + drive blanks (1) 75mm I2C Backplane-to-Backplane jumper cable (1 set) mounting hardware <p>Required (Sold Separately): SAS / SATA Data Cables. See section 4.2.5</p>	<ul style="list-style-type: none"> • 2U 2.5" Drive Upgrade Kit • 2U Building Block Accessory Kit
<p>iPC – A2U8X25S3DPDK</p> 	<p>MM# – 935067 UPC – 00735858288774 EAN – 5032037068055 MOQ – 1</p>	<p>8x2.5" Dual Port SAS Front Mount Hot Swap Drive Bay Module for all 2U 2.5" systems</p> <p>Kit Includes:</p> <ul style="list-style-type: none"> (1) Drive Bay Assembly Module (1) 8x2.5" hot swap backplane (8) 2.5" drive carriers + drive blanks (1) 75mm I2C Backplane-to-Backplane jumper cable (1 set) mounting hardware <p>Required (Sold Separately): SAS / SATA Data Cables. See section 4.2.5</p>	<ul style="list-style-type: none"> • 2U 2.5" Drive Upgrade Kit • 2U Building Block Accessory Kit

For a 2U building block configuration consisting of 24x2.5” drives (3 drive bays – See Figure 10) or when upgrading a R2208WT or R2216WT system to a 24 drive R2224WT system, the 2U storage front panel option of Intel Accessory Kit A2UHANDLKIT must be installed.

Intel Product Code	Order Information	Product Description	Product Type
<p>iPC – A2UHANDLKIT</p> 	<p>MM# – 936038 UPC – 00735858288866 EAN – 5032037068147 MOQ – 1</p>	<p>1U / 2U Rack Handle Kit</p> <p>This kit includes 3 different rack handles, including:</p> <p>(1) Set of 2U storage rack handles with control panel and USB support (R2312WT & R2224WT)</p> <p>(1) Set of 2U non –storage rack handles (R2208WT & R2216WT)</p> <p>(1) Set of 1U rack handles (R1304WT & R1208WT)</p>	<ul style="list-style-type: none"> • 2U – 24 2.5” Drive Upgrade Kit • 1U / 2U Spares Kit

See the *Intel Server System R2000WT Product Family System Integration and Service Guide* for complete system integration and upgrade instructions.

5.7 Locking Front Bezel Accessory Kits

The optional front bezel is made of Black molded plastic and uses a snap-on design. When installed, its design allows for maximum airflow to maintain system cooling requirements. The front bezel includes a keyed locking mechanism which can be used to prevent unauthorized access to installed storage devices and front I/O ports.

5.7.1 2U Front Bezel Accessory Kit – iPC A2UBEZEL

Intel Product Code	Order Information	Product Description	Product Type
<p>iPC – A2UBEZEL</p> 	<p>MM# – 918086 UPC – 735858241137 EAN – 5032037035880 MOQ – 1</p>	<p>2U Front Bezel Accessory Kit</p> <p>Kit Includes:</p> <ul style="list-style-type: none"> (1) 2U locking bezel (1) Front Panel Window Insert (1 Set) Bezel branding inserts – two ID badges, one wave (1 Set) Keys 	<ul style="list-style-type: none"> • 2U Accessory Kit

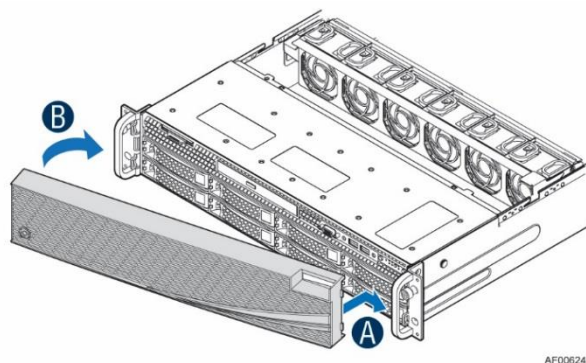

AF006243

The face of the bezel assembly includes snap-in identification badge options and a wave feature option to allow for customization.

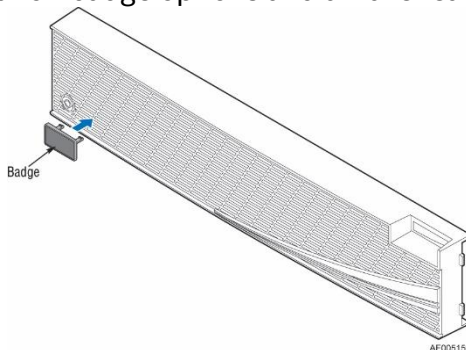

AF005159

5.7.2 1U Front Bezel Accessory Kit – iPC A1UBEZEL

Intel Product Code	Order Information	Product Description	Product Type
<p>iPC – A1UBEZEL</p> 	<p>MM# – 917983 UPC – 735858241120 EAN – 5032037035873 MOQ – 1</p>	<p>1U Front Bezel Accessory Kit</p> <p>Kit Includes:</p> <ul style="list-style-type: none"> (1) 1U locking bezel (1) Front Panel Window Insert (1 Set) Bezel branding inserts – two ID badges, one wave (1 Set) Keys 	<ul style="list-style-type: none"> • 1U Accessory Kit

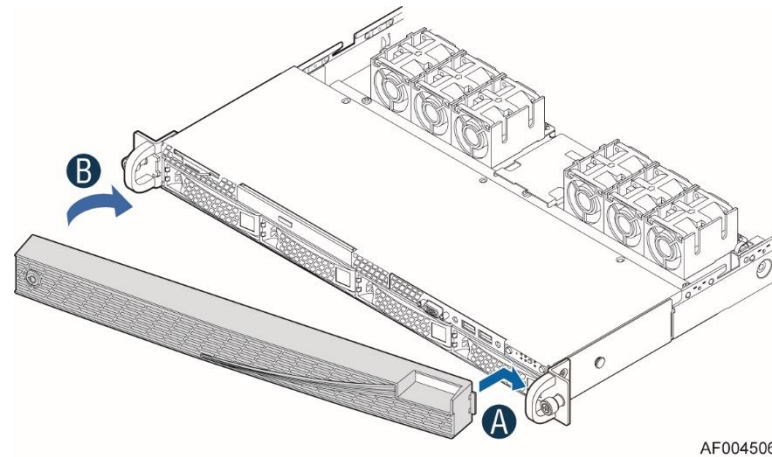

The face of the bezel assembly includes snap-in identification badge options and a wave feature option to allow for customization.

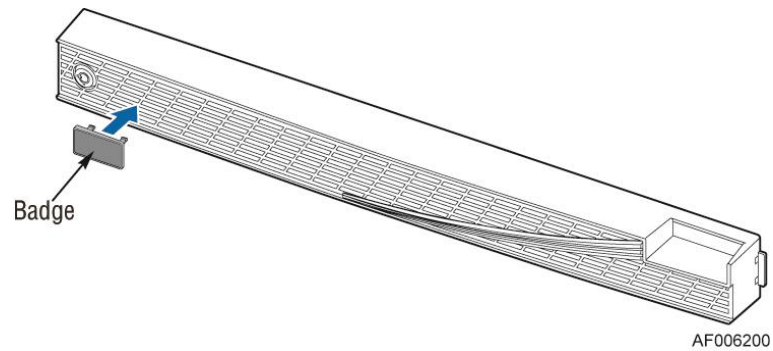

5.8 1U / 2U PCIe* Riser Card Accessory/Spares FRU Options

The Intel® Server Board S2600WT provides three riser slots. Riser slots 1 and 2 are capable of supporting different riser card options to meet needs of specific system configurations. Riser card options for riser slots 1 and 2 are common. Riser slot 3 is only supported in 2U system configurations and can only support a riser capable of supporting low profile PCIe* add-in cards.

All PCIe* bus lanes to the riser slots are routed from the processors. Riser slot 1 has a total of 24 PCIe* 3.0 bus lanes routed from both processors; 16 lanes from processor #1 and 8 lanes from processor #2. Riser slot 2 has a total of 24 PCIe* 3.0 bus lanes routed from CPU 2. For riser slot 3, all PCIe* bus lanes are routed from CPU 2; 8 PCIe* bus lanes are PCIe* 3.0 compatible and 4 PCIe* lanes are PCIe* 2.0 compatible. See the product Technical Product Specification (TPS) for additional information.

Riser slots 1 and 2 are capable of supporting up to 100W maximum power each. Available power to each add-in card slot on a given riser card is defined by the PCIe* specification. The server board provides two Auxiliary 12V power connectors that when cabled (iPC **AXXGPGUCABLE**), can provide additional power to high power PCIe* add-in cards.

5.8.1 1U Riser Card Options

Intel Product Code	Order Information	Product Description	Product Type
iPC – F1UL16RISER2 	MM# – 934884 UPC – 00735858288682 EAN – 5032037067966 MOQ – 1	1U 1-slot PCIe riser card option One PCIe* add-in card slot – PCIe* x16, x16 mechanical Kit includes: (1) Riser card PCBA	<ul style="list-style-type: none"> • 1U Building Block Accessory Kit • 1U Spare FRU

Each riser card assembly has support for a single full height, ½ length PCIe* add-in card. However, riser card #2 may be limited to ½ length, ½ height add-in cards if either of the two mini-SAS HD connectors on the server board are used.

Note: Add-in cards that exceed the PCI specification for ½ length PCI add-in cards (167.65mm or 6.6in) may interfere with other installed devices on the server board.

5.8.2 2U Riser Card Options

Intel Product Code	Order Information	Product Description	Product Type								
<p>iPC – A2UL8RISER2</p> 	<p>MM# – 934885 UPC – 00735858288675 EAN – 5032037067959 MOQ – 1</p>	<p>2U 3-slot PCIe* riser card option</p> <p>Riser Slots #1 & #2 Riser Card Option</p> <table border="1"> <thead> <tr> <th>Slot #</th> <th>Description</th> </tr> </thead> <tbody> <tr> <td>Slot-1 (Top)</td> <td>PCIe* x8 elec, x16 mechanical</td> </tr> <tr> <td>Slot-2 (Middle)</td> <td>PCIe* x8 elec, x16 mechanical</td> </tr> <tr> <td>Slot-3 (Bottom)</td> <td>PCIe* x8 elec, x8 mechanical</td> </tr> </tbody> </table> <p>Kit includes: (1) riser card PCBA</p>	Slot #	Description	Slot-1 (Top)	PCIe* x8 elec, x16 mechanical	Slot-2 (Middle)	PCIe* x8 elec, x16 mechanical	Slot-3 (Bottom)	PCIe* x8 elec, x8 mechanical	<ul style="list-style-type: none"> • 2U Building Block Accessory Kit • 2U Spare FRU
Slot #	Description										
Slot-1 (Top)	PCIe* x8 elec, x16 mechanical										
Slot-2 (Middle)	PCIe* x8 elec, x16 mechanical										
Slot-3 (Bottom)	PCIe* x8 elec, x8 mechanical										

Each 3-slot riser card assembly has support for up to two full height full length add-in cards (top and middle slots) and one full height ½ length add-in card (bottom slot).

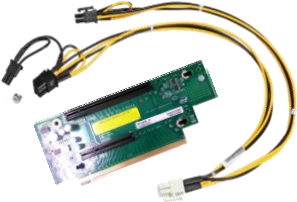
Intel Product Code	Order Information	Product Description	Product Type						
<p>iPC – A2UL16RISER2</p> 	<p>MM# – 934886 UPC – 00735858288668 EAN – 5032037067942 MOQ – 1</p>	<p>2U 2-slot PCIe* Riser card option</p> <p>Riser Slots #1 & #2 Riser Card Option</p> <table border="1"> <thead> <tr> <th>Slot #</th> <th>Description</th> </tr> </thead> <tbody> <tr> <td>Slot-1 (Top)</td> <td>PCIe* x16 elec, x16 mechanical</td> </tr> <tr> <td>Slot-2 (Bottom)</td> <td>PCIe* x8 elec, x8 mechanical</td> </tr> </tbody> </table> <p>Kit includes: (1) Riser card PCBA (1) 12V-AUX Power Cable</p>	Slot #	Description	Slot-1 (Top)	PCIe* x16 elec, x16 mechanical	Slot-2 (Bottom)	PCIe* x8 elec, x8 mechanical	<ul style="list-style-type: none"> • 2U Building Block Accessory Kit • 2U Spare FRU <p>* Required Kit for Intel® Xeon Phi™ or high power PCIe* add-in card support</p>
Slot #	Description								
Slot-1 (Top)	PCIe* x16 elec, x16 mechanical								
Slot-2 (Bottom)	PCIe* x8 elec, x8 mechanical								

Each 2-slot riser card assembly has support for one full height full length add-in card (top slot) and one full height ½ length add-in card (bottom slot).

Note: The **A2UL16RISER2** accessory kit includes a 12V Auxiliary Power cable which can be used to provide additional 12V power for high power PCIe* add-in cards that require it.

Note: The x16 2-slot riser card is included in Intel Accessory Kit A2U44X25NVMEDK. Systems configured with the A2U44X25NVMEDK accessory kit cannot support dual Intel® Xeon Phi™ coprocessor cards or dual non-Intel GPGPU cards.

Intel Product Code	Order Information	Product Description	Product Type						
<p>iPC – A2UX8X4RISER</p> 	<p>MM# – 934883 UPC – 00735858283311 EAN – 5032037064378 MOQ – 1</p>	<p>2U 2-slot riser card option Riser Slot #3 (only) Riser Card Option</p> <table border="1" data-bbox="852 293 1516 477"> <thead> <tr> <th>Slot #</th> <th>Description</th> </tr> </thead> <tbody> <tr> <td>Slot-1 (Top)</td> <td>PCIe* x4 elec, x8 mechanical (PCIe* 2.0 support only)</td> </tr> <tr> <td>Slot-2 (Bottom)</td> <td>PCIe* x8 elec, x8 mechanical</td> </tr> </tbody> </table> <p>Kit includes: (1) Riser card PCBA</p>	Slot #	Description	Slot-1 (Top)	PCIe* x4 elec, x8 mechanical (PCIe* 2.0 support only)	Slot-2 (Bottom)	PCIe* x8 elec, x8 mechanical	<ul style="list-style-type: none"> • 2U Building Block Accessory Kit • 2U Spare FRU
Slot #	Description								
Slot-1 (Top)	PCIe* x4 elec, x8 mechanical (PCIe* 2.0 support only)								
Slot-2 (Bottom)	PCIe* x8 elec, x8 mechanical								

Riser Slot #3 is provided to support up to two additional PCIe* add-in card slots for 2U server configurations. The available riser card option is designed to support low profile add-in cards only.

5.9 Intel® I/O Expansion Modules

The Intel® S2600WT product family includes support for a number of optional Intel® I/O modules that install onto proprietary connectors on the server board leaving all available PCIe* add-in cards slots available for other add-in card options. The onboard high density interface connector has x8 PCIe* 3.0 bus lanes routed to it from CPU 1.

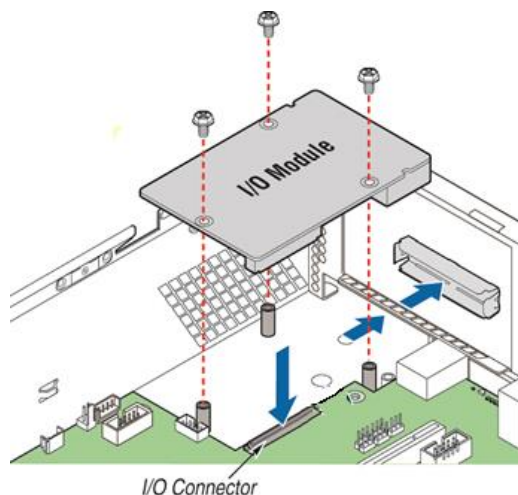









Figure 17. Intel® I/O Module Installation

Intel Product Code	Order Information	Product Description	Product Type
<p>iPC – AXX1P40FRTIOM</p>  <p>iPC – AXX2P40FRTIOM</p> 	<p>MM# – 933742 UPC – 00735858282291 EAN – 5032037063623 MOQ – 1</p> <p>MM# – 933743 UPC – 00735858282314 EAN – 5032037063647 MOQ – 1</p>	<p>Intel® I/O Modules AXX1P40FRTIOM & AXX2P40FRTIOM</p> <p>Intel® Single and Dual-Port 40G QSFP+ Ethernet I/O Modules based on XL710-QDA1 and XL710-QDA2 10 Gigabit Ethernet Controllers</p> <p>On the dual port module, the 4x10GbE SFP+ break out is supported on Port 0 only</p> <p>Available Optics Accessories:</p> <ul style="list-style-type: none"> • Intel® Ethernet QSFP+ SR4 Optics, E40GQSFPSR • Intel® Ethernet 40G DCO Optics, E40GDCCOQSFP <p>Connector and cables:</p> <ul style="list-style-type: none"> • 40GBASE-CR4, QSFP+ Direct Attached Copper Cable • Intel® Ethernet QSFP+ SR4 Optics also supported • Intel® Ethernet 40G DCO Optics, E40GDCCOQSFP <p>Cabling type:</p> <ul style="list-style-type: none"> • 10GBASE-CR4: Copper Direct Attach passive cable (1–7m); • 10GBASE-SR4: MMF (OM3) up to 100m • Intel® Ethernet 40G DCO Optics up to 50m <p>Kits Include:</p> <ul style="list-style-type: none"> (1) I/O module (1) EMI shield (1) Port Labeling Sticker (2 Port only model) (1 set) Mounting screws 	<ul style="list-style-type: none"> • 1U / 2U Accessory Kit
<p>iPC – AXX10GBNIAIOM</p> 	<p>MM# – 917905 UPC – 00735858241090 EAN – 5032037035842 MOQ – 1</p>	<p>Intel® I/O Module AXX10GBNIAIOM</p> <p>Dual SFP+ port 10GbE IO module based on Intel® 82599ES 10 Gigabit Ethernet Controller</p> <p>Kit Includes:</p> <ul style="list-style-type: none"> (1) I/O module (1) EMI shield (1) Port Labeling Sticker (1 set) Mounting screws 	<ul style="list-style-type: none"> • 1U / 2U Accessory Kit

Intel Product Code	Order Information	Product Description	Product Type
<p>iPC – AXX10GBTWLIOM3</p> 	<p>MM – 941869 UPC – 00735858296656 EAN – 5032037072472 MOQ – 1</p>	<p>Intel® I/O Module AXX10GBTWLIOM3 Dual RJ-45 port 10GBASE-T IO module, based on Intel® Ethernet Controller X540</p> <p>Kit Includes: (1) I/O module (1) EMI shield (1) Port Labeling Sticker (1 set) Mounting screws</p>	<ul style="list-style-type: none"> 1U / 2U Accessory Kit
<p>iPC – AXX1FDRIBIOM</p> 	<p>MM – 918607 UPC – 00735858241106 EAN – 5032037035859 MOQ – 1</p>	<p>Intel® I/O Module AXX1FDRIBIOM Single port, FDR 56GT/S speed Intel® I/O Expansion Infiniband* module</p> <p>Kit Includes: (1) I/O module (1) EMI shield (1) Port Labeling Sticker (1 set) Mounting screws</p>	<ul style="list-style-type: none"> 1U / 2U Accessory Kit
<p>iPC – AXX2FDRIBIOM</p> 	<p>MM – 920627 UPC – 00735858245722 EAN – 5032037040235 MOQ – 1</p>	<p>Intel® I/O Module AXX2FDRIBIOM Dual port, FDR 56GT/S (per port capable) speed Infiniband* module</p> <p>Kit Includes: (1) I/O module (1) EMI shield (1) Port Labeling Sticker (1 set) Mounting screws</p>	<ul style="list-style-type: none"> 1U / 2U Accessory Kit

Intel Product Code	Order Information	Product Description	Product Type
<p>5.9.1 iPC – AXX4P1GBPWL IOM</p> 	<p>MM – 917911 UPC – 00735858241083 EAN – 5032037035835 MOQ – 1</p>	<p>Intel® I/O Module AXX4P1GBPWL IOM Quad port 1GbE IO Module based on Intel® Ethernet Controller I350</p> <p>Kit Includes: (1) I/O module (1) EMI shield (1) Port Labeling Sticker (1 set) Mounting screws</p>	<ul style="list-style-type: none"> • 1U / 2U Accessory Kit

5.10 Intel® SAS RAID Add-in Cards, Modules, and Accessories

Intel® RAID offers a broad portfolio of RAID solutions designed to address the storage-related challenges of the modern day datacenter as well as the small business. The Intel® S2600WT product family includes support for the latest generation of 12 Gb/s SAS Intel® RAID add-in cards, modules, expanders, and accessories. Previous generation 6Gb/s Intel RAID cards can also be supported. See the published Tested Hardware and OS List for a full list of validated Intel RAID cards.

Additional information for Intel RAID products can be found at the following Intel web sites:

<https://www.intel.com/content/www/us/en/products/servers/raid/raid-controllers.html?page=2>



<https://www.intel.com/content/www/us/en/servers/raid/tri-mode-raid-controller-brief.html>



<https://www.intel.com/content/dam/www/public/us/en/documents/product-briefs/tri-mode-raid-controller-brief.pdf>



5.10.1 Intel® Integrated RAID Module RMS3 Product Family – SAS 3.0 (12 Gb/s)

Each riser card assembly has support for a single full height, ½ length PCIe* add-in card. However, riser card #2 may be limited to ½ length, ½ height add-in cards if either of the two mini-SAS HD connectors on the server board are used or if a SATADOM storage device is installed into either of the single port SATA connectors.



Note: Add-in cards that exceed the PCI specification for ½ length PCI add-in cards (167.65mm or 6.6in) may interfere with other installed devices on the server board.



Intel Product Code	Order Information	Product Description	Product Type
<p>iPC – RMS3CC080</p> 	<p>MM# – 932474 UPC – 00735858276832 EAN – 5032037060448 MOQ - 5</p>	<p>Intel® Integrated RAID Module RMS3CC080 Mezzanine Form Factor HW RAID Module 8 internal SAS / SATA ports Mini-SAS HD SFF8643 connectors LSI* SAS3108 ROC with 1GB DDR3 RAID Levels 0, 1, 5, 6, 10, 50, 60 Embedded 1GB DDR3 Cache Memory Supports Maintenance Free Backup Unit – iPC AXXRMFBU5</p> <p>SAS Data cables not included . Must be purchased separately</p>	<ul style="list-style-type: none"> • 1U / 2U Accessory Kit
<p>iPC – RMS3CC040</p> 	<p>MM# –932473 UPC – 00735858276849 EAN – 5032037060455 MOQ – 5</p>	<p>Intel® Integrated RAID Module RMS3CC040 Mezzanine Form Factor HW RAID Module 4 internal SAS / SATA ports Mini-SAS HD SFF8643 connectors LSI* SAS3108 ROC with 1GB DDR3 RAID Levels 0, 1, 5, 6, 10, 50, 60 Embedded 1GB DDR3 Cache Memory Supports Maintenance Free Backup Unit – iPC AXXRMFBU5</p> <p>SAS Data cables not included . Must be purchased separately</p>	<ul style="list-style-type: none"> • 1U / 2U Accessory Kit



Intel Product Code	Order Information	Product Description	Product Type
<p>iPC – RMS3HC080</p> 	<p>MM – 932469 UPC – 00735858276818 EAN – 5032037060424 MOQ – 5</p>	<p>Intel® Integrated RAID Module RMS3HC080 Mezzanine Form Factor Entry-RAID Module 8 internal SAS / SATA ports Mini-SAS HD SFF8643 connectors LSI* SAS3008 SAS IOC with Advanced Management Entry HW RAID levels – JBOD, RAID 0,1,10 & Hybrid 5,50 128MB server board memory utilized as cache memory for RAID 5/50</p> <p>SAS Data cables not included . Must be purchased separately</p>	<ul style="list-style-type: none"> • 1U / 2U Accessory Kit
<p>iPC – RMS3JC080</p> 	<p>MM – 932472 UPC – 00735858276825 EAN – 5032037060431 MOQ – 5</p>	<p>Intel® Integrated RAID Module RMS3JC080 Mezzanine Form Factor Entry-RAID Module 8 internal SAS / SATA ports Mini-SAS HD SFF8643 connectors LSI* SAS3008 IOC with Basic Firmware Entry HW RAID levels – JBOD, RAID 0, 1, 1E, 10</p> <p>SAS Data cables not included . Must be purchased separately</p>	<ul style="list-style-type: none"> • 1U / 2U Accessory Kit
<p>iPC – RMS3VC160</p> 	<p>MM – 946902 UPC – 00735858308595 EAN – 5032037081351 MOQ – 5</p>	<p>Intel® Integrated RAID Module RMS3VC160 Mezzanine Form Factor Entry-RAID Module 12Gb/s (SAS 3.0) 16 internal port SAS/SATA PCIe 3.0 dual core I/O Controller (IOC) Entry HW RAID levels – JBOD Only</p> <p>SAS Data cables not included . Must be purchased separately</p>	<ul style="list-style-type: none"> • 1U / 2U Accessory Kit

Intel Product Code	Order Information	Product Description	Product Type
<p>iPC – RMS3AC160</p> 	<p>MM – 947032 UPC – 00735858308571 EAN – 5032037081337 MOQ – 5</p>	<p>Intel® Integrated RAID Module RMS3VC160 Mezzanine Form Factor Entry-RAID Module 12Gb/s (SAS 3.0) 16 internal port SAS/SATA PCIe 3.0 dual core I/O Controller (IOC) Entry HW RAID levels – 0, 1, 10, 5, 50, 6, 60 and JBOD Compatible with Cache Backup accessory “AXXRMFBU6”</p> <p>SAS Data cables not included . Must be purchased separately</p>	<ul style="list-style-type: none"> • 1U / 2U Accessory Kit
<p>iPC – AXXRMFBU5</p> 	<p>MM# – 933907 UPC – 00735858306768 EAN – 5032037060417 MOQ – 5</p>	<p>Intel® RAID Maintenance Free Backup Unit AXXRFMBU5 A super-capacitor module and flash memory card designed to help protect data in dynamic memory during a power failure or system crash event. The AXXRMFBU5 kit is used with the 12 Gb/s Intel® Integrated RAID Modules</p> <p>Compatible with:</p> <ul style="list-style-type: none"> • Intel® Integrated RAID Module RMS3CC080 • Intel® Integrated RAID Module RMS3CC040 	<ul style="list-style-type: none"> • 1U / 2U Accessory Kit
<p>iPC – AXXRMFBU6</p> 	<p>MM# – 945975 UPC – 00735858276801 EAN – 5032037080163 MOQ – 5</p>	<p>Intel® RAID Maintenance Free Backup Unit AXXRFMBU6 A super-capacitor module and flash memory card designed to help protect data in dynamic memory during a power failure or system crash event. The AXXRMFBU6 kit is used with the 12 Gb/s Intel® Integrated RAID Modules</p>	<ul style="list-style-type: none"> • 1U / 2U Accessory Kit



5.10.1.1 Intel® RAID Controller Add-in Cards - SAS 3.0 (12Gb/s)



Intel Product Code	Order Information	Product Description	Product Type
<p>iPC – RS3DC080</p> 	<p>MM# – 934643 UPC – 00735858265355 MOQ – 5</p>	<p>Intel® RAID Controller RS3DC080 Low Profile, half length, (MD2 Compliant) PCIe* add-in card 8 internal SAS / SATA ports LSI* SAS3108 ROC RAID Levels – 0, 1, 5, 6, 10, 50, and 60 Embedded 1GB DDR3 Cache Memory Supports Maintenance Free Backup Unit – iPC AXXRMFBU4</p> <p>SAS Data cables not included . Must be purchased separately</p>	<ul style="list-style-type: none"> • 1U / 2U Accessory Kit
<p>iPC – RS3DC040</p> 	<p>MM# – 934644 UPC – 00735858265362 MOQ – 5</p>	<p>Intel® RAID Controller RS3DC040 Low Profile, half length, (MD2 Compliant) PCIe* add-in card 4 internal SAS / SATA ports LSI* SAS3108 ROC RAID Levels – 0, 1, 5, 6, 10, 50, and 60 Embedded 1GB DDR3 Cache Memory Supports Maintenance Free Backup Unit – iPC AXXRMFBU4</p> <p>SAS Data cables not included . Must be purchased separately</p>	<ul style="list-style-type: none"> • 1U / 2U Accessory Kit
<p>iPC – RS3SC008</p> 	<p>MM# – 928223 UPC – 00735858266956 EAN – 5032037068567 MOQ – 5</p>	<p>Intel® RAID Controller RS3SC008 Low Profile, half length, (MD2 Compliant) PCIe* add-in card 8 external SAS / SATA ports LSI* SAS3108 ROC RAID Levels – 0, 1, 5, 6, 10, 50, and 60 Embedded 1GB DDR3 Cache Memory Supports Maintenance Free Backup Unit – iPC AXXRMFBU4</p> <p>SAS Data cables not included . Must be purchased separately</p>	<ul style="list-style-type: none"> • 1U / 2U Accessory Kit

Intel Product Code	Order Information	Product Description	Product Type
<p>iPC – RS3MC044</p> 	<p>MM# – 928244 UPC – 00735858266987 EAN – 5032037068574 MOQ – 5</p>	<p>Intel® RAID Controller RS3MC044 Low Profile, half length, (MD2 Compliant) PCIe* add-in card 4 internal SAS / SATA ports + 4 external SAS / SATA ports LSI* SAS3108 ROC RAID Levels – 0, 1, 5, 6, 10, 50, and 60 Embedded 1GB DDR3 Cache Memory Supports Maintenance Free Backup Unit – iPC AXXRMFBU4</p> <p>SAS Data cables not included . Must be purchased separately</p>	<ul style="list-style-type: none"> • 1U / 2U Accessory Kit
<p>iPC – RS3GC008</p> 	<p>MM# – 928220 UPC – 00735858267175 EAN – 5032037053839 MOQ – 5</p>	<p>Intel® RAID Controller RS3GC008 Low Profile, half length, (MD2 Compliant) PCIe* add-in card Entry Level SAS Card 8 external SAS / SATA ports LSI* SAS3008 IOC RAID Levels – JBOD (SAS Connectivity)</p> <p>SAS Data cables not included. Must be purchased separately</p>	<ul style="list-style-type: none"> • 1U / 2U Accessory Kit
<p>iPC – RS3UC080</p> 	<p>MM# – 928218 UPC – 00735858267649 EAN – 5032037053938 MOQ – 5</p>	<p>Intel® RAID Controller RS3UC080 Low Profile, half length, (MD2 Compliant) PCIe* add-in card Entry Level SAS RAID Card 8 internal SAS / SATA ports LSI* SAS3008 IOC RAID Levels – 0, 1, 1E, 10, and JBOD</p> <p>SAS Data cables not included. Must be purchased separately</p>	<ul style="list-style-type: none"> • 1U / 2U Accessory Kit

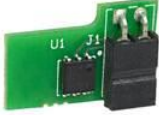
Intel Product Code	Order Information	Product Description	Product Type
<p>iPC – RS3FC044</p> 	<p>MM# – 928219 UPC – 00735858267267 EAN – 5032037053921 MOQ – 5</p>	<p>Intel® RAID Controller RS3FC044 Low Profile, half length, (MD2 Compliant) PCIe* add-in card Entry Level SAS RAID Card 4 internal + 4 external SAS / SATA ports LSI* SAS3008 IOC RAID Levels – 0, 1, 1E, 10, and JBOD</p> <p>SAS Data cables not included. Must be purchased separately</p>	<ul style="list-style-type: none"> • 1U / 2U Accessory Kit
<p>iPC – AXRMFBU4</p> 	<p>MM# – 937318 UPC – 00735858273787 EAN – 5032037058544 MOQ – 5</p>	<p>Intel® RAID Maintenance Free Backup Unit AXRMFBU4 A super-capacitor module and flash memory card designed to help protect data in dynamic memory during a power failure or system crash event.</p> <p>The AXRMFBU4 kit is used with the 12 Gb/s Intel® RAID Controller PCIe* Add-in Cards</p> <p>Compatible with:</p> <ul style="list-style-type: none"> • Intel® RAID Controller RS3DC080 • Intel® RAID Controller RS3DC040 • Intel® RAID Controller RS3SC008 • Intel® RAID Controller RS3MC044 	<ul style="list-style-type: none"> • 1U / 2U Accessory Kit

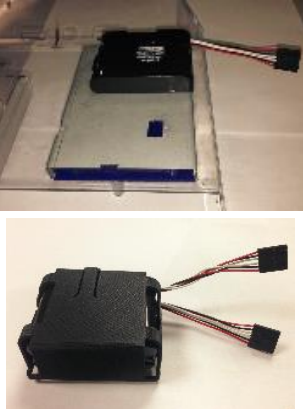

5.10.2 Intel® RAID Accessory Options

Intel Product Code	Order Information	Product Description	Product Type
iPC – AXXPFKSSD2 	MM# – 919499 UPC – 00735858221467 EAN - 5032037051699 MOQ – 5	Intel® RAID SSD Cache with Fast Path I/O Upgrade Key to enable SSD Cache with Fastpath I/O for Intel®'s RAID RS25 and RS3 (based on LSI 3108) families of ROC products.	<ul style="list-style-type: none"> 1U / 2U Accessory Kit
iPC – AXXPFKDE2 	MM# – 915317 UPC – 00735858221474 EAN - 5032037051705 MOQ – 5	Intel® RAID Drive Encryption Management Upgrade Key to enable Drive Encryption Management for Intel®'s RAID RS25 and RS3 (based on LSI 3108) families of ROC products.	<ul style="list-style-type: none"> 1U / 2U Accessory Kit
iPC – AXXPFKSNH2 	MM# – 915318 UPC – 00735858221481 EAN - 5032037051712 MOQ – 5	Intel® RAID Rapid Recovery Snapshot Upgrade Key to enable Rapid Recovery Snapshot for Intel®'s RAID RS25 and RS3 (based on LSI 3108) families of ROC products.	<ul style="list-style-type: none"> 1U / 2U Accessory Kit
iPC – RKSATA4R5 	MM# – 916346 UPC – 00735858238861 EAN – 5032037033640 MOQ - 5	ESRT2 SATA SW RAID activation key Used to enable onboard SATA controllers to support embedded ESRT2 SW RAID 5	<ul style="list-style-type: none"> 1U / 2U Accessory Kit





Intel Product Code	Order Information	Product Description	Product Type
<p>iPC – AXRMFBU5</p> 	<p>MM# – 933907 UPC – 00735858276801 EAN – 5032037060417 MOQ – 5</p>	<p>Intel® RAID Maintenance Free Backup Unit AXRMFBU5</p> <p>A super-capacitor module and flash memory card designed to help protect data in dynamic memory during a power failure or system crash event.</p> <p>The AXRMFBU5 kit is used with the 12 Gb/s Intel® Integrated RAID Modules</p> <p>Compatible with:</p> <ul style="list-style-type: none"> • Intel® Integrated RAID Module RMS3CC080 • Intel® Integrated RAID Module RMS3CC040 	<ul style="list-style-type: none"> • 1U / 2U Accessory Kit
<p>iPC – AXRMFBU4</p> 	<p>MM# – 937318 UPC – 00735858273787 EAN – 5032037058544 MOQ – 5</p>	<p>Intel® RAID Maintenance Free Backup Unit AXRMFBU4</p> <p>A super-capacitor module and flash memory card designed to help protect data in dynamic memory during a power failure or system crash event.</p> <p>The AXRMFBU4 kit is used with the 12 Gb/s Intel® RAID Controller PCIe* Add-in Cards</p> <p>Compatible with:</p> <ul style="list-style-type: none"> • Intel® RAID Controller RS3DC080 • Intel® RAID Controller RS3DC040 • Intel® RAID Controller RS3SC008 <p>Intel® RAID Controller RS3MC044</p>	<ul style="list-style-type: none"> • 1U / 2U Accessory Kit
<p>iPC - AWTAUXBBUBKT</p> 	<p>MM# – 937082 UPC – 00735858289344 EAN – 5032037068321 MOQ – 1</p>	<p>1U / 2U RMFBU Mounting Option Kit</p> <p>Kit includes:</p> <p>(1) – 2U RMFBU Mounting plate. The mounting plate installs in one of two possible mounting locations in front of either riser slot on the 2U air duct and can support up to two AXRMFBU5 or AXRSBBU9 units. Full length PCIe cards cannot be supported when this mounting plate is installed behind the given riser slot.</p> <p>(1) – RMFBU plastic housing bracket to support two stacked AXRMFBU5 units in a 1U chassis</p>	<ul style="list-style-type: none"> • 1U / 2U Accessory Kit

5.11 Intel® PCI Express NVMe Add-in Cards

Intel® offers the PCIe NVMe Add-in cards as solutions designed to address the storage-Performance related challenges of the modern day datacenter as well as the small business. The Intel® S2600WT product family includes support for the latest generation PCI Express* Gen3 SSDs (NVMeS).

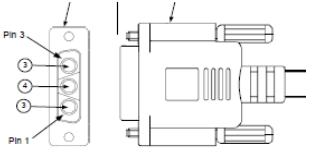

Intel Product Code	Order Information	Product Description	Product Type
<p>iPC – AXX4PX8HDAIC</p> 	<p>MM# – 947923 UPC – 00735858315548 EAN – 5032037086547 MOQ – 1</p>	<p>Intel® PCI Express 8-Lane, 4-Port Fan-Out Switch</p> <p>The Intel® PCI Express 8-Lane, 4-Port Fan-Out Switch is ideal for increasing the number of NVMe SSDs in systems where PCIe lanes from the CPU are limited.</p> <ul style="list-style-type: none"> • Compatible with standard PCIe * SIG x8 or x16 PCIe slots. • Comes with full height and low profile mounting brackets. • Mini-SAS HD cables included for cabling to NVMe drives / backplanes <p>Max Data Rate: Integrated SerDes supports 8.0 GT/s Gen3; 5.0 GT/s Gen2 and 2.5 GT/s Gen1 operation</p>	<ul style="list-style-type: none"> • 2U Accessory Kit
<p>iPC – A1U2PXR3HDAIC</p> 	<p>MM# – 947925 UPC – 00735858315531 EAN – 5032037086530 MOQ – 1</p>	<p>1U PCIe* Switch Riser 3 Card Kit supporting 2x PCIe* SSD drives</p> <p>Kit Includes:</p> <ul style="list-style-type: none"> (1) 1U PCIe* Switch Riser (2) PCIe* SSD Drives (1) Mini-SAS HD cables Included for cabling to NVMe drives 	<ul style="list-style-type: none"> • 1U Accessory Kit

5.12 Intel Power Supply Modules and Power Cords

Intel Product Code	Order Information	Product Description	Product Type
iPC – AXX1100PCRPS 	MM# – 936183 UPC – 00735858287920 EAN – 5032037067478 MOQ - 1	1100W AC CRPS 80+ Platinum efficiency power supply module Power cord sold separately	<ul style="list-style-type: none"> • 2U Building Block Option • 2U Accessory Kit • 2U Spare FRU
iPC – FXX750PCRPS 	MM# – 915604 UPC – 00735858234979 EAN – 5032037030601 MOQ - 1	750W AC CRPS 80+ Platinum efficiency power supply module Power cord sold separately	<ul style="list-style-type: none"> • 1U / 2U Building Block Option • 1U / 2U Accessory Kit • 1U / 2U Spare FRU
iPC – AXX750DCCRPS 	MM# – 927253 UPC – 00735858260862 EAN – 5032037051354 MOQ - 1	750W -48v DC (Direct current) CRPS 80+ Gold efficiency power supply module Kit Includes: (1) power supply (1) O-ring terminal adapter. Power cable sold separately	<ul style="list-style-type: none"> • 1U / 2U Building Block Option • 1U / 2U Accessory Kit • 1U / 2U Spare FRU
iPC – AXXDCCRPSCL 	MM – 922062 UPC – 00735858247993 EAN – 5032037042871 MOQ – 1	4000mm (13ft) DC power cable. Connects directly to power supply instead of O-ring terminals adapter	<ul style="list-style-type: none"> • 1U / 2U Accessory Kit • 1U / 2U Spare FRU
iPC – FPWRCABLENA 	MM# – 879287 UPC – 00735858181129 EAN – 5032037015738 MOQ – 1	1500mm (59in) North American Power Cord	<ul style="list-style-type: none"> • 1U / 2U Accessory Kit • 1U / 2U Spare FRU

5.13 1U / 2U Rack Mount Kits

Caution: Exceeding the rail kit's specified maximum weight limit or misalignment of the server in the rack may result in failure of the rack rails, resulting in damage to the system or personal injury. Using two people or the use of a mechanical assist tool to install and align the server into the rack is highly recommended.

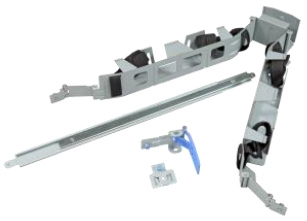
Intel Product Code	Order Information	Product Description	Product Type
<p>5.13.1 iPC - AXXPRAIL</p> 	<p>MM# – 924417 UPC – 00735858219686 EAN – 5032037014823 MOQ – 1</p>	<p>1U / 2U Premium Rail Kit</p> <ul style="list-style-type: none"> • 1U and 2U compatible • Adjustment within 609.6mm~762mm to fit difference depth rack • 800mm maximum travel length • Full extension from rack • 54 lbs (24 kgs) max support weight • Tool-less installation • Drop in system install • For Cable Management arm support – order iPC AXX1U2UCMA 	<ul style="list-style-type: none"> • 1U / 2U Accessory Kit
<p>5.13.2 iPC – AXVELVRAIL</p> 	<p>MM# – 920970 UPC – 00735858244367 EAN – 5032037038980 MOQ - 1</p>	<p>1U / 2U Enhanced Value Rail Kit</p> <ul style="list-style-type: none"> • Works for all 438mm wide Intel® Rack Chassis 1U, 2U, 4U • Adjustment within 609.6mm~765mm to fit difference depth rack • 424.2mm maximum travel length • 2/3 extension from rack • 130 lbs (59 kgs) max support weight • Tool-less chassis attach • Tools required to attach to rails to rack <p>Note: No Cable Management Arm support.</p>	<ul style="list-style-type: none"> • 1U / 2U Accessory Kit
<p>5.13.3 iPC – AXX1U2UCMA</p> 	<p>MM# – 913117 UPC – 00735858224604 EAN – 5032037019972 MOQ – 1</p>	<p>1U / 2U Cable Management Arm (CMA)</p> <ul style="list-style-type: none"> • 1U / 2U compatible • Support for Premium 1U/2U AXXPRAIL and 1U A1UFULLRAIL rail kit options only 	<ul style="list-style-type: none"> • 1U / 2U Accessory Kit

Intel® Server S2600WT Product Family Configuration Guide and Spares/Accessories List

Intel Product Code	Order Information	Product Description	Product Type
<p>iPC - AXX2POSTBRCKT</p> 	<p>MM# – 918808 UPC – 00735858245319 EAN – 5032037039833 MOQ – 1</p>	<p>1U / 2U 2-Post fixed mount bracket kit</p> <ul style="list-style-type: none"> • 1U and 2U compatible • Tools required to attach components to rack <p>Note: Not compatible with 24x2.5" drive or 12x3.5" drive system configurations</p>	<ul style="list-style-type: none"> • 1U / 2U Accessory Kit
<p>iPC – A1USHRTRAIL</p>	<p>MM# – 939208 UPC –00735858289931 EAN –5032037068772 MOQ – 1</p>	<p>1U Premium quality rails with no CMA support</p> <ul style="list-style-type: none"> • Travel distance 780mm • Bracket adjustment from 609.6mm to 762mm • Supports up to 18Kg • Tool-less installation • Full extension from rack <p>Kit includes: Rails, screws, installation manual</p>	<ul style="list-style-type: none"> • 1U Accessory Kit
<p>iPC – A1UFULLRAIL</p>	<p>MM# –939207 UPC –00735858291972 EAN –5032037070539 MOQ – 1</p>	<p>1U Premium quality rails with CMA support.</p> <ul style="list-style-type: none"> • Travel distance 780mm • Bracket adjustment from 609.6mm to 762mm • Tool-less installation • Full extension from rack • Supports up to 18Kg • Kit includes: Rails, screws, installation manual <p>For Cable Management arm support – order iPC AXX1U2UCMA</p>	<ul style="list-style-type: none"> • 1U Accessory Kit
<p>iPC - AXXSHRTRAIL</p>	<p>MM# – 939210 UPC – 00735858291996 EAN – 5032037070553 MOQ – 1</p>	<p>2U+ Premium quality rails with no CMA support.</p> <ul style="list-style-type: none"> • Travel distance 788mm • Bracket adjustment from 594.8mm to 813mm • Tool-less installation • Supports up to 45Kg • Full extension from rack • Kit includes: Rails, screws, installation manual 	<ul style="list-style-type: none"> • 2U Accessory Kit

Intel Product Code	Order Information	Product Description	Product Type
iPC – AXXFULLRAIL	MM# –939209 UPC –00735858291989 EAN –5032037070546 MOQ – 1	<p>2U+ Premium quality rails with CMA support.</p> <ul style="list-style-type: none"> • Travel distance 800mm • Bracket adjustment from 594.8mm to 813mm • Tool-less installation • Supports up to 45Kg • Full extension from rack • Kit includes: Rails, screws, installation manual • For Cable Management arm – order iPC AXXCMA2 	<ul style="list-style-type: none"> • 2U Accessory Kit
iPC – AXXCMA2	MM# – 939211 UPC –00735858292009 EAN –5032037070560 MOQ – 1	<p>Cable management arm</p> <p>Compatible with AXXFULLRAIL only</p>	<ul style="list-style-type: none"> • 2U Accessory Kit

5.13.4 Intel® Xeon Phi™ Coprocessor Card and Non-Intel GPGPU Support

Intel® Xeon Phi™ Coprocessor cards and non-Intel GPGPU cards are supported in the following 2U system configurations only: **R2208WT, R2308WT, and R2216WT.**

Because of mechanical and thermal limits, the **1U product family** and the **R2312WT... and R2224WT...** system configurations do NOT have support for Intel® Xeon Phi™ coprocessor cards or non-Intel GPGPU cards.

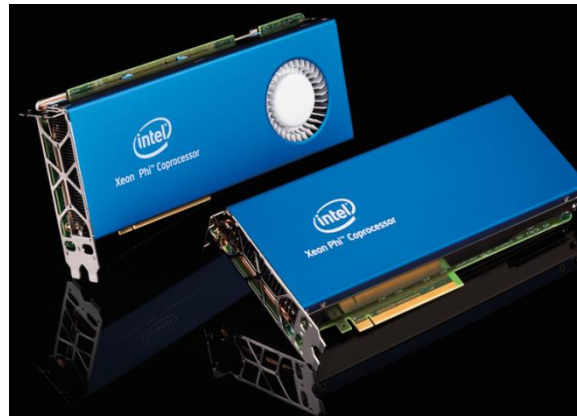
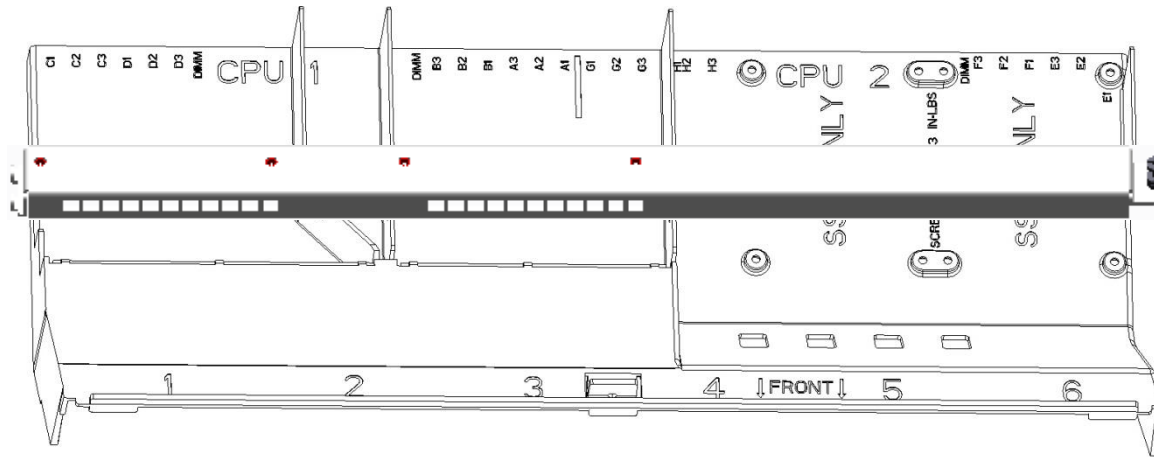

Figure 18. Intel® Xeon Phi™ Coprocessor Cards With Active and Passive Cooling

- Supported 2U systems configured with the standard (default) air duct, can only support high power add-in cards (>75W) with active (with fan) heat sinks.

- In supported 2U system, high power add-in cards (>75W) with passive (no fan) heat sinks can only be supported in systems configured with a high air flow air duct available in Intel Accessory Kit – iPC **AWTCOPRODUCT**.



Note: Intel® Server System **R2208WTTYC1R** is a special system SKU that includes the necessary components to support passive high power (>75W) add-in cards like the Intel® Xeon Phi™ coprocessor card, **Intel® Visual Compute Accelerator or** non-Intel GPGPU cards.

See the *Intel® Server System R2000WT product family Technical Product Specification* for more information.

Non-Intel GPGPU Support Disclaimer:

Intel incorporates necessary features and conducts appropriate thermal testing of its server systems to ensure the thermal requirements of Intel® Xeon Phi™ coprocessor cards can be supported when the documented support criteria are met.

Intel can make support recommendations for non-Intel GPGPU cards listed on its Tested Hardware and Support List, based on the same support criteria. However, Intel cannot guarantee its server systems can meet the thermal requirements of these non-Intel high power add-in cards. System integrators should verify non-Intel GPGPU add-in card air flow and thermal requirements from vendor specifications before integrating them into the system. It is the responsibility of the system integrator to conduct appropriate system testing on server systems configured with a non-Intel GPGPU card to ensure reliable operation.

For non-Intel GPGPU cards listed on Intel's tested hardware and OS list, Intel will provide best internal support efforts to duplicate and understand reported issues. However, Intel cannot guarantee an issue will be root caused nor that a fix can be made available to correct it.

Intel Product Code	Order Information	Product Description	Product Type
<p>iPC – AWTCOPRODUCT</p> 	<p>MM# – 934988 UPC – 00735858283328 EAN – 5032037064385 MOQ – 1</p>	<p>2U High Air flow Air Duct Kit</p> <p>Required 2U accessory kit when installing an Intel® Xeon Phi™ coprocessor card with passive heat sink (heat sink only, no fan)</p> <p>Kit Includes:</p> <ul style="list-style-type: none"> (1) High air flow air duct (1) Metal shipping bracket (2) Non-intel GPGPU secure mounting adapters <p>Note: Intel Xeon Phi cards with active heat sinks are NOT supported in systems configured with the high air flow air duct.</p> <p>Note: Systems configured with any type of Intel® Xeon Phi™ card and/or non-Intel GPGPU card must have the shipping bracket installed before the system is exposed to any level of shock or vibration or is shipped to the end user location. Failure to install the shipping bracket has the potential to cause serious damage to various components within the system.</p>	<ul style="list-style-type: none"> • 2U Accessory Kit



- Each Intel® Xeon Phi™ coprocessor card and non-Intel GPGPU card must be installed into the top x16 slot of a 2-Slot PCIe* Riser card. With a 2-slot riser card installed, the embedded fan speed control will operate system fans at a higher speed. 3-slot riser cards (as shipped in the standard platform configuration) cannot be used due to air flow and thermal limitations.



Intel Product Code	Order Information	Product Description	Product Type						
<p>iPC – A2UL16RISER2</p> 	<p>MM# – 934886 UPC – 00735858288668 EAN – 5032037067942 MOQ – 1</p>	<p>2U 2-slot riser card</p> <p>Required 2U accessory kit when installing an Intel® Xeon Phi™ coprocessor or other Non-Intel GPGPU card</p> <table border="1" data-bbox="863 1122 1421 1224"> <thead> <tr> <th>Slot #</th> <th>Description</th> </tr> </thead> <tbody> <tr> <td>Slot-1 (Top)</td> <td>PCIe* x16 elec, x16 mechanical</td> </tr> <tr> <td>Slot-2 (Bottom)</td> <td>PCIe* x8 elec, x8 mechanical</td> </tr> </tbody> </table> <p>Kit includes:</p> <ul style="list-style-type: none"> (1) Riser card PCBA (1) 12V-AUX Power Cable 	Slot #	Description	Slot-1 (Top)	PCIe* x16 elec, x16 mechanical	Slot-2 (Bottom)	PCIe* x8 elec, x8 mechanical	<ul style="list-style-type: none"> • 2U Building Block Accessory Kit • 2U Spare FRU
Slot #	Description								
Slot-1 (Top)	PCIe* x16 elec, x16 mechanical								
Slot-2 (Bottom)	PCIe* x8 elec, x8 mechanical								



5.14 Intel® I/O Expansion Add-in Cards

Intel Product Code	Order Information	Product Description	Product Type
<p>iPC – 100HFA016LS</p> 	<p>MM# – 948159 UPC – 00735858313445 EAN – 5032037084970 MOQ – 1</p>	<p>2U 2-slot riser card</p> <p>Intel® Omni-Path Host Fabric Interface Adapter 100 Series 1</p> <ul style="list-style-type: none"> • Designed specifically for HPC • Single port • Link speed 100Gb/s • Port PCIe x16 Low Profile and Std Height Brackets 	<ul style="list-style-type: none"> • 1U / 2U Accessory Kit

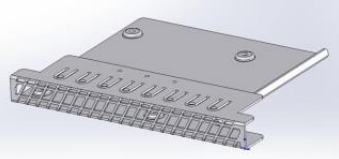
6 1U / 2U Miscellaneous Accessory Options

Intel Product Code	Order Information	Product Description	Product Type
<p data-bbox="184 444 432 477">iPC – A1U2ULCP</p> 	<p data-bbox="562 428 726 451">MM# – 921028</p> <p data-bbox="562 464 831 487">UPC – 00735858245302</p> <p data-bbox="562 500 819 522">EAN – 5032037039826</p> <p data-bbox="562 535 655 558">MOQ – 1</p>	<p data-bbox="1129 289 1423 311">Intel® Local Control Panel</p> <p data-bbox="898 326 1640 349">A 1U / 2U front panel module which supports the following features:</p> <ul data-bbox="947 363 1388 467" style="list-style-type: none"> • 2 line LCD screen • Customized messaging • Able to display critical system errors <p data-bbox="898 482 1619 597">When installed this module replaces the front I/O port module on R1304, R1208, R2308, R2208, and R2216 based systems. The LCP module re-uses the existing front USB port assembly from these systems. It does NOT support a front video connector.</p> <p data-bbox="898 651 1608 673">This Kit is NOT compatible with R2224 and R2312 based systems.</p> <p data-bbox="898 727 1644 781">See the <i>Intel® Local Control Panel Technical Product Specification</i> for more information</p>	<ul data-bbox="1682 524 1965 547" style="list-style-type: none"> • 1U / 2U Accessory Kit
<p data-bbox="128 834 491 867">iPC – AXXSATADVROM</p> 	<p data-bbox="562 867 726 889">MM# – 937569</p> <p data-bbox="562 902 831 925">UPC – 00735858197663</p> <p data-bbox="562 938 819 961">EAN – 5032037015127</p> <p data-bbox="562 974 655 997">MOQ – 1</p>	<p data-bbox="1108 816 1444 839">Slimline SATA DVDROM Drive</p> <p data-bbox="898 854 1213 876">Includes 880mm SATA cable</p> <p data-bbox="898 891 1587 950">A peripheral power cable is included with the systems that have support for optical drives</p> <p data-bbox="898 1003 1598 1057">Optical drives are not supported in R2312WT & R2224WT based systems</p>	<ul data-bbox="1682 924 1965 946" style="list-style-type: none"> • 1U / 2U Accessory Kit
<p data-bbox="100 1122 518 1154">iPC – AXXSATADVDRWROM</p> 	<p data-bbox="562 1154 726 1177">MM# – 937575</p> <p data-bbox="562 1190 831 1213">UPC – 00735858197670</p> <p data-bbox="562 1226 819 1248">EAN – 5032037015134</p> <p data-bbox="562 1261 655 1284">MOQ – 1</p>	<p data-bbox="1066 1104 1486 1127">Slimline SATA DVD+/-RW ROM Drive</p> <p data-bbox="898 1141 1213 1164">Includes 880mm SATA cable</p> <p data-bbox="898 1179 1587 1237">A peripheral power cable is included with the systems that have support for optical drives</p> <p data-bbox="898 1291 1598 1344">Optical drives are not supported in R2312WT & R2224WT based systems</p>	<ul data-bbox="1682 1214 1965 1237" style="list-style-type: none"> • 1U / 2U Accessory Kit



Intel Product Code	Order Information	Product Description	Product Type
<p>iPC - AXXSSDODDKIT</p> 	<p>MM# – 935065 UPC – 00735858288750 EAN – 5032037068031 MOQ – 1</p>	<p>1U fixed mount SSD mounting Kit</p> <p>Tray is installed in the optical drive bay of 1U systems.</p> <p>Kit includes:</p> <ul style="list-style-type: none"> (1) – Metal SSD mounting tray accomodates one 2.5" SATA SSD (1) – 800mm SATA data cable (1) – SSD peripheral power cable <p>Note: Maximum SSD thickness supported = 7mm Note: Systems configured with this kit cannot support an additional optical drive</p>	<ul style="list-style-type: none"> • 1U Accessory Kit
<p>iPC - AXXRJ45DB93</p> 	<p>MM# – 920430 UPC – 00735858242820 EAN – 5032037037525 MOQ – 1</p>	<p>Serial Port Cable Kit</p> <p>This kit provides serial port cables for use with systems that include a back panel cut out to support a DB9 Serial 'B' port as routed from the server board and for systems that include an external RJ45 Serial 'A' port that need to convert the connector to a DB9 style connector.</p> <p>Kit includes:</p> <ul style="list-style-type: none"> (1) - 1040mm Internal Serial 'B' port cable – Onboard DH10 header-to- External Mount DB9 – for 2U systems (1) - 520mm Internal Serial 'B' port cable – Onboard DH10 header-to- External mount DB9 – for 2U systems (1) – 100mm DCD RJ45 to DB9 Dongle (1) – 100mm DSR RJ45 to DB9 Dongle 	<ul style="list-style-type: none"> • 1U / 2U Accessory Kit
<p>iPC - AXXRMM4LITE</p> 	<p>MM# – 911660 UPC – 00735858219297 EAN – 5032037014946 MOQ – 1</p>	<p>Intel® Remote Management Module 4 Lite Activation key</p> <p>Installation of this activation key on to the server board enables support for the following advanced server management features:</p> <ul style="list-style-type: none"> • Integrated KVM • Media Redirection <p>See the <i>Intel Remote Management Module 4 and Integrated Web Console Users Guide</i> for more information.</p>	<ul style="list-style-type: none"> • 1U / 2U Accessory Kit

Intel Product Code	Order Information	Product Description	Product Type
<p>iPC - AXXRMM4LITE2</p> 	<p>MM# – 946514 UPC – 00735858307413 EAN – 5032037080750 MOQ – 10</p>	<p>Intel® Remote Management Module 4 Lite version 2 – RoHS free</p> <p>Installation of this activation key on to the server board enables support for the following advanced server management features:</p> <ul style="list-style-type: none"> • Integrated KVM • Media Redirection • RoHS free <p>See the Intel Remote Management Module 4 and Integrated Web Console Users Guide for more information.</p>	<ul style="list-style-type: none"> • 1U / 2U Accessory Kit
<p>iPC - AXXTPME5</p> 	<p>MM# – 919737 UPC – 00735858240352 EAN – 5032037035088 MOQ – 1</p>	<p>Intel® Trusted Platform Module (TPM)</p> <p>A TPM is a hardware-based security device that addresses the growing concern on boot process integrity and offers better data protection. TPM protects the system start-up process by ensuring it is tamper-free before releasing system control to the operating system. A TPM device provides secured storage to store data, such as security keys and passwords. In addition, a TPM device has encryption and hash functions.</p> <p>AXXTPME5 implements TPM as per TPM PC Client specifications revision 1.2 by the Trusted Computing Group (TCG)</p>	<ul style="list-style-type: none"> • 1U / 2U Accessory Kit
<p>iPC – AXXTPME6</p> 	<p>MM# – 947921 UPC – 00735858314534 EAN – 5032037086059 MOQ – 10</p>	<p>Intel® Trusted Platform Module (TPM)</p> <p>A TPM is a hardware-based security device that addresses the growing concern on boot process integrity and offers better data protection. TPM protects the system start-up process by ensuring it is tamper-free before releasing system control to the operating system. A TPM device provides secured storage to store data, such as security keys and passwords. In addition, a TPM device has encryption and hash functions.</p> <p>AXXTPME6 implements TPM as per TPM PC Client specifications revision 2.0 by the Trusted Computing Group (TCG)</p>	<ul style="list-style-type: none"> • 1U / 2U Accessory Kit



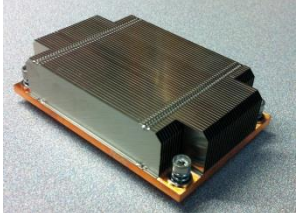
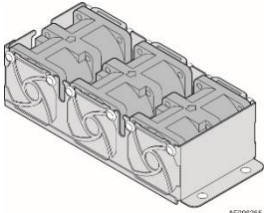

Intel Product Code	Order Information	Product Description	Product Type
<p data-bbox="184 240 436 272">iPC – AXxTPME7</p> 	<p data-bbox="562 337 726 358">MM# – 947922</p> <p data-bbox="562 375 831 396">UPC – 00735858314541</p> <p data-bbox="562 412 819 433">EAN – 5032037086066</p> <p data-bbox="562 449 674 470">MOQ – 10</p>	<p data-bbox="1066 170 1486 191">Intel® Trusted Platform Module (TPM)</p> <p data-bbox="1031 246 1522 267">Note: <u>AXxTPME7 compatible for use in China</u></p> <p data-bbox="898 326 1654 532">A TPM is a hardware-based security device that addresses the growing concern on boot process integrity and offers better data protection. TPM protects the system start-up process by ensuring it is tamper-free before releasing system control to the operating system. A TPM device provides secured storage to store data, such as security keys and passwords. In addition, a TPM device has encryption and hash functions.</p> <p data-bbox="898 587 1654 641">AXxTPME7 implements TPM as per TPM PC Client specifications revision 2.0 by the Trusted Computing Group (TCG)</p>	<ul data-bbox="1682 393 1965 414" style="list-style-type: none"> • 1U / 2U Accessory Kit



7 1U / 2U Spare and Replacement Parts (FRUs)

System integrators and distributors may choose to hold additional stock of individual system components. Intel makes available the following Spare and Replacement Parts (FRUs) compatible with the specified Intel server family.

Intel Product Code	Order Information	Product Description	Product Type
iPC – FXXFPANEL2 	MM# – 937543 UPC – 00735858288712 EAN – 5032037067997 MOQ – 1	Front Panel board spare for use on 1U/2U rack systems (R1000, R2000 except R2224 and R2312) Rack chassis and P4000 Pedestal Chassis. Different from FXXFPANEL by 0.6mm offset of reset and power buttons.	<ul style="list-style-type: none"> 1U / 2U Spare FRU
iPC – FXXCA84X106HS 	MM# – 918318 UPC – 00735858236676 EAN - 5032037031448 MOQ – 2	1U Heat Sink FXXCA84X106HS (Cu/Al 84mmx106mm)	<ul style="list-style-type: none"> 1U / 2U Spare FRU
iPC - FR1UFAN10PW 	MM# – 935064 UPC – 00735858283342 EAN – 5032037064408 MOQ – 1	Three spare fans for 1U R1000WT system. 40x56mm dual rotor with 10p connector. Includes 3 fans in the bracket, with grommets preinstalled.	<ul style="list-style-type: none"> 1U Spare FRU
iPC - FR2UFAN60HSW 	MM# – 934990 UPC – 00735858283359 EAN – 5032037064415 MOQ – 1	Two spare fans for 2U R2000WT system. 60x38mm, with hot swap connector. Includes 2 fans with finger guards and housing.	<ul style="list-style-type: none"> 2U Spare FRU

Intel® Server S2600WT Product Family Configuration Guide and Spares/Accessories List

Intel Product Code	Order Information	Product Description	Product Type
<p>iPC – FR1304S3HSBP2</p> 	<p>MM# – 947357 UPC – 00735858309264 EAN – 5032037081856 MOQ – 1</p>	<p>Hot swap backplane board spare for 1U 4x3.5" chassis (R1304 family). RoHs compliance.</p>	<ul style="list-style-type: none"> • 1U Spare FRU
<p>iPC – F1U8X25S3HSBP</p> 	<p>MM# – 934888 UPC – 00735858288798 EAN – 5032037068079 MOQ – 1</p>	<p>Hot swap backplane board spare for 1U 8x2.5" chassis (R1208 family).</p>	<ul style="list-style-type: none"> • 1U Spare FRU
<p>iPC – FXX8X25S3HSBP</p> 	<p>MM# – 934890 UPC – 00735858288804 EAN – 5032037068086 MOQ – 1</p>	<p>Single port hot swap backplane board spare for 2U 8x2.5" cage (R2200 and P4000 families). Includes one backplane board.</p>	<ul style="list-style-type: none"> • 2U Spare FRU
<p>iPC – F2U8X35S3HSBP</p> 	<p>MM# – 934892 UPC – 00735858288811 EAN – 5032037068093 MOQ – 1</p>	<p>Hot swap backplane board spare for 2U 8x3.5" chassis (R2308 family). Includes one backplane board.</p>	<ul style="list-style-type: none"> • 2U Spare FRU
<p>iPC – F2U12X35S3HSBP</p> 	<p>MM# – 934893 UPC – 00735858288828 EAN – 5032037068109 MOQ – 1</p>	<p>Hot swap backplane board spare for 2U 12x3.5" chassis (R2312 family). Includes one backplane board.</p>	<ul style="list-style-type: none"> • 2U Spare FRU

Intel Product Code	Order Information	Product Description	Product Type
<p>iPC – A2UHANDLKIT</p> 	<p>MM# – 936038 UPC – 00735858288866 EAN – 5032037068147 MOQ – 1</p>	<p>1U / 2U Rack Handle Kit</p> <p>This kit includes 3 different rack handles, including:</p> <p>(1) Set of 2U storage rack handles with control panel and USB support (R2312WT & R2224WT)</p> <p>(1) Set of 2U non –storage rack handles (R2208WT & R2216WT)</p> <p>(1) Set of 1U rack handles (R1304WT & R1208WT)</p>	<ul style="list-style-type: none"> • 2U – 24 2.5" Drive Upgrade Kit • 1U / 2U Spares Kit
<p>iPC – FXX25HSCAR2</p> 	<p>MM# – 937542 UPC – 00735858289405 EAN – 5032037068383 MOQ – 8</p>	<p>Spare 2.5" HDD hot swap carriers.</p>	<ul style="list-style-type: none"> • 1U / 2U Spare FRU
<p>iPC – FXX35HSCAR</p> 	<p>MM# – 936192 UPC – 00735858289412 EAN – 5032037068390 MOQ – 8</p>	<p>Spare 3.5" hot swap drive carriers. Includes mounting screws for mounting 2.5" SSDs.</p>	<ul style="list-style-type: none"> • 1U / 2U Spare FRU

8 Intel® Visual Compute Accelerators

The Intel® Visual Compute Accelerator brings 4K Ultra High Definition (UHD) media processing capabilities to Intel® Xeon® processor E5 platforms. The Intel® Visual Compute Accelerator card integrates three Intel® Xeon® E3 processors with Intel® Iris™ Pro graphics and Intel® Media Server Studio-enabled hardware accelerated video processing into a PCIe* card form factor that fits into Intel® Xeon® processor E5-based servers.

- Offer fast transcoding for video into multiple formats and bit rates reducing the amount of time needed to process the video inputs
- Reduce the amount of storage needed for those multiple formats through higher compression processing
- Allow for real time transcoding into multiple formats from the stored format, reducing the need to store all possible media formats
- Reduces the amount of network bandwidth needed (lower bit rates) at better video quality by compressing the video prior to transmission

The Intel® Visual Compute Accelerator is uniquely capable of supporting the different media processing solutions as it contains three Intel Xeon processor E3 v4 with Intel Iris Pro Graphics P6300; placing these three processors on a Gen3 x16 PCIe card provides high throughput and low latency when moving data to and from the card.

Intel Product Code	Order Information	Product Description	Product Type
<p>iPC – VCA1283LVV</p> 	<p>MM# – 942876 UPC – 00735858309493 EAN – 5032037081986 MOQ – 1</p>	<ul style="list-style-type: none"> • Full-length, full-height, double width Gen3 PCIe x16 • 4 Cores Supported • 47W TDP • Processor Numer E3-1283L v4 • Base freq 2.9 GHz, Max Turbo freq 3.8 GHz • Max Memory size 96GB (DDR3-1333/1600/1866) <p>Note: it requires to purchase separately the accessory spare "AWTCOPRODUCT"</p>	<ul style="list-style-type: none"> • 2U Accessory Kit

Intel Product Code	Order Information	Product Description	Product Type
<p>iPC – VCA1585LMV</p> 	<p>MM# – 954907 UPC – 00735858334532 EAN – 5032037099127 MOQ – 1</p>	<ul style="list-style-type: none"> • Full-length, full-height, double width Gen3 PCIe x16 • 4 Cores Supported • 235W Max TDP • 3 x Intel® Xeon® processors E3-1585L v5 • Base freq 3.0 GHz, Max Turbo freq 3.7 GHz • Max Memory size 64GB (DDR4 ECC SODIMMs, 2 channels per CPU) • 8 MB cache <p>Note: it requires to purchase separately the accessory spare "AWTCOPRODUCT"</p>	<ul style="list-style-type: none"> • 2U Accessory Kit

9 Software Security - McAfee® Antivirus for Intel® Server Systems*

McAfee® Antivirus for Intel® Server Systems Accessory is a software accessory offered with the Intel® Server Systems S2600WT product family. It safeguards systems and files from viruses and other security risks that it detects and removes malware, and configures antivirus policies to manage quarantined items.

The McAfee® Antivirus for Intel® Server Systems Accessory provides the latest version of either McAfee® Virus Scan® Enterprise for Windows or McAfee® VirusScan® Enterprise for Linux. There are downloadable 1- or 3-year license and 1- or 3-year renewals at the end of the licensing term.

9.1 How to order it?

Customers have the opportunity to purchase McAfee® Antivirus for Intel® Server Systems from an Intel authorized distributor. Upon placing an order for one or more McAfee® Antivirus for Intel® Server Systems SKU(s) and registering their purchase, they will receive a certificate from McAfee, asking them to register the software. Once Registered, they will receive a grant letter from McAfee that includes download instructions.

See <http://www.intelserveredge/mcafeeaccessory> for more information.

Note: This accessory will only be offered from the Intel site with a qualifying Intel® Server System purchase.

Learn more at:



<http://www.intelserveredge/mcafeeaccessory>.

9.2 McAfee® Antivirus for Intel® Server Systems

Intel Product Code	Order Information	Description	Supported Operating Systems
iPC – SWMAVSE1YR	MM# – 946352 MOQ - 1	1 year license (30-day grace period at end of the term), Two download options: McAfee® VirusScan Enterprise or McAfee® VirusScan Enterprise for Linux*. *Renewal option available for 1- and 3- year terms.	Supported Operating systems can be located on the Server compatibility list on (THOL) or external web http://www.intel.com/content/www/us/en/support/server-products/server-boards/dual-socket-server-boards/intel-server-board-s2600wt-family.html
iPC – SWMAVSE3YR	MM# – 946354 MOQ - 1	3 year license (30-day grace period at end of the term), Two download options: McAfee® VirusScan Enterprise or McAfee® VirusScan Enterprise for Linux*. *Renewal option available for 1- and 3- year terms.	
iPC – SWMAVSERN1YR	MM# – 946381 MOQ - 1	1 year renewal of existing license. Renewal option available.	
iPC – SWMAVSERN3YR	MM# – 946383 MOQ - 1	3 year renewal of existing license. Renewal option available.	

Support link <http://support.intel.com/support/motherboards/server/sb/CS-035755.htm>

10 Extended Warranty

Image	Order Information	Description
 <p>Intel Server Component Extended Warranty Key <small>Component Order Code</small></p> <p>Expiration: 30 Days</p> <p>Instructions to enable Intel® Server Component Extended Warranty</p> <ol style="list-style-type: none"> 1. Register your system online at the Intel® Server System, Intel® Server Board, Intel® Server Rack, or Intel® Server Blade only by going to the online page at the following URL: www.intel.com/go/ServerWarranty 2. Log in with your Intel® Server System, Intel® Server Board, Intel® Server Rack, or Intel® Server Blade account. If you do not have an account, you can create one. For more information, see the "How to Register" section of the online page at the following URL: www.intel.com/go/ServerWarranty 3. Add the Intel® Server Component Extended Warranty to your system. 	<p>iPC – SVCEWDPSY MM# – 911295 MOQ – 1</p>	<p>Two year extended warranty for Intel® Server Systems or Intel® Server Knock Down Kits + Intel® Server Boards that support two processors. Intel® RAID controller extended warranty is purchased separately.</p>
 <p>Intel Server Component Extended Warranty Key <small>Component Order Code</small></p> <p>Expiration: 30 Days</p> <p>Instructions to enable Intel® Server Component Extended Warranty</p> <ol style="list-style-type: none"> 1. Register your system online at the Intel® Server System, Intel® Server Board, Intel® Server Rack, or Intel® Server Blade only by going to the online page at the following URL: www.intel.com/go/ServerWarranty 2. Log in with your Intel® Server System, Intel® Server Board, Intel® Server Rack, or Intel® Server Blade account. If you do not have an account, you can create one. For more information, see the "How to Register" section of the online page at the following URL: www.intel.com/go/ServerWarranty 3. Add the Intel® Server Component Extended Warranty to your system. 	<p>iPC - SVCEWDPBD MM# – 911294 MOQ – 1</p>	<p>Two year extended warranty for Intel® Server Boards that support two processors.</p>
 <p>Intel Server Component Extended Warranty Key <small>Component Order Code</small></p> <p>Expiration: 30 Days</p> <p>Instructions to enable Intel® Server Component Extended Warranty</p> <ol style="list-style-type: none"> 1. Register your system online at the Intel® Server System, Intel® Server Board, Intel® Server Rack, or Intel® Server Blade only by going to the online page at the following URL: www.intel.com/go/ServerWarranty 2. Log in with your Intel® Server System, Intel® Server Board, Intel® Server Rack, or Intel® Server Blade account. If you do not have an account, you can create one. For more information, see the "How to Register" section of the online page at the following URL: www.intel.com/go/ServerWarranty 3. Add the Intel® Server Component Extended Warranty to your system. 	<p>iPC - SVCEWRAID MM# – 911298 MOQ – 1</p>	<p>Two year extended warranty for Intel® RAID controllers. Batteries are not included in the Extended Warranty. RAID expanders are included as part of the system SKU</p>

Glossary of Terms

A list of Acronyms and Terms used throughout this document:

Acronym or Term	Definition	Acronym or Term	Definition
BIK	Baseboard In Knock-Down-Kit – Integrated System	NVMe	NVM Express – based on Non-Volatile Memory Host Controller Interface Specification (NVMeHCI)
CRPS	Common Redundant Power Supply	Optional Accessory	Hardware that can be added to the system to enhance the default feature set of the shipping configuration
EAN	International Article Number (Barcode)	PCBA	Printed Circuit Board Assembly
EMI	Electromagnetic Interference	QSFP	Quad Small Form factor Pluggable
ESRT2	Intel® Embedded Server RAID Technology 2	RAID	Redundant Array of Independent Drives
FDR Infiniband	Fourteen Data Rate Infiniband	Required Option	Hardware that must be added to the shipping configuration for the system to operate
FRU	Field Replaceable Unit	RMFBU	RAID Maintenance Free Backup Unit
GPGPU	General Purpose computing on Graphics Processing Unit	RMM4 Lite	Intel® Remote Management Module 4 Lite Activation key
iPC	Intel Product Code	ROC	RAID on Chip
iPN	Intel Product Number	RSTe	Intel® Rapid Storage Technology
JBOD	Just a bunch of drives	SAS	Serial Attached SCSI
L6 BIK	Integrated system with no processors, memory, or storage devices installed	SATA	Serial ATA
L8 BIK	Integrated system including storage devices, but no processors or memory	SFF NVMe	NVMe SSD in a 2.5" form factor
LCP	Intel® Local Control Panel	SFP	Small Form factor Pluggable
KDK	Knock-Down-Kit – (Chassis only product)	SKU	Stock Keeping Unit
KVM	Keyboard / Video / Mouse	SSD	Solid State Drive
MM#	Master Material order number	UPC	Universal Product Code (Barcode)
MOQ	Minimum Order Quantity		

X-ON Electronics

Largest Supplier of Electrical and Electronic Components

Click to view similar products for [Specialised Cables category](#):

Click to view products by [Intel manufacturer](#):

Other Similar products are found below :

[603PT6](#) [603SS6L](#) [604PT6](#) [604SS6](#) [706000D02F200](#) [910640](#) [1200740077](#) [1200740114](#) [AC172](#) [ACL-SSI-4](#) [R88ACAKA0015SRE](#)
[R88ACAWL005SDE](#) [R88ACRGD0R3C](#) [1300150047](#) [1300660036](#) [1302262116](#) [1300150149](#) [1300220020](#) [1300220104](#) [1300220119](#)
[1301240492](#) [1301810221](#) [1365323-1](#) [1613055](#) [176P12](#) [1971465-2](#) [20240400003](#) [20240400013](#) [2085828-1](#) [20886510030](#) [2-22733-8](#) [22733-](#)
[8](#) [CB-5PSBC-RS](#) [CB-704EC-RS](#) [CB-BATACC-RS](#) [CB-JST3PSW-RS](#) [CB-M12COM-R10](#) [25AC84](#) [25AK84X](#) [25AU25](#) [25FN82](#) [3011-03](#)
[AC118](#) [ACL-HHS-1M\(CAT5E\)](#) [SSL009PC2DC012N](#) [FC2A-KC6C](#) [2085828-2](#) [20886510150](#) [CCS-FCB-5](#) [CCSFCBF2](#)