

NOT RECOMMENDED FOR NEW DESIGN

The Altera® Enpirion® EY1603 is a wide input voltage range, low quiescent current linear regulator ideally suited for “always-on” and “keep alive” applications. The EY1603 operates from an input voltage of +6V to +40V under normal operating conditions and consumes only 18µA of quiescent current at no load.

The EY1603 has an adjustable output voltage range from 1.223V to 12V. The EY1603 features an $\overline{\text{EN}}$ pin that can be used to put the device into a low-quiescent current shutdown mode where it draws only 2µA of supply current. The device features automatic thermal shutdown and current limit protection.

The EY1603 is rated over the -40°C to +125°C temperature range and is available in a 14 lead HTSSOP with an exposed pad package.

TABLE 1. KEY DIFFERENCES IN FAMILY OF 40V LDO PARTS

PART NUMBER	MINIMUM I_{OUT}	ADJ OR FIXED V_{OUT}
EY1602SI-ADJ	50mA	ADJ
EY1603TI-ADJ	150mA	ADJ

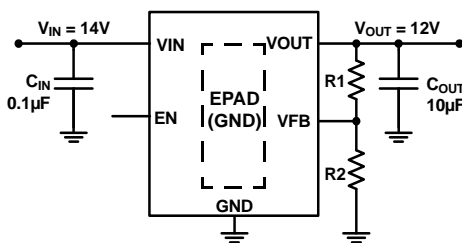

FIGURE 1. TYPICAL APPLICATION

Features

- Wide V_{IN} Range of 6V to 40V
- Adjustable Output Voltage from 1.223V to 12V
- Guaranteed 150mA Output Current
- Ultra Low 18µA Typical Quiescent Current
- Low 2µA of Typical Shutdown Current
- ±1% Accurate Voltage Reference
- Low Dropout Voltage of 295mV at 150mA
- 40V Tolerant Logic Level (TTL/CMOS) Enable Input
- Stable Operation with 10µF Output Capacitor
- 5kV ESD HBM Rated
- Thermal Shutdown and Current Limit Protection
- Thermally Enhanced 14 Ld Exposed Pad HTSSOP Package

Applications

- Industrial
- Telecommunications

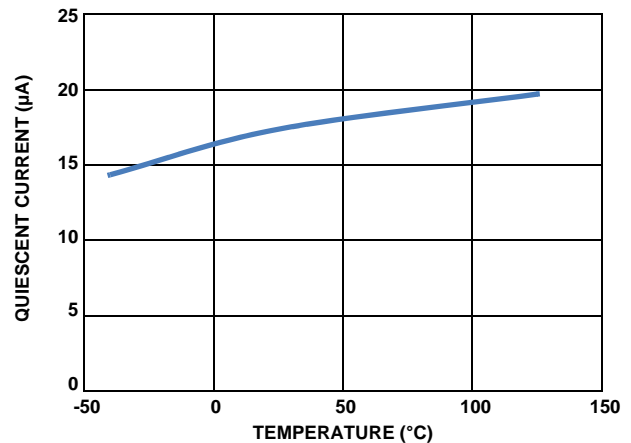

FIGURE 2. QUIESCENT CURRENT vs TEMPERATURE (AT UNITY GAIN), $V_{\text{IN}} = 14\text{V}$

Ordering Information

PART NUMBER (Notes 1, 2)	PART MARKING	TEMP. RANGE (°C)	ENABLE PIN	OUTPUT VOLTAGE (V)	PACKAGE (Pb-Free)	PKG. DWG. #
EY1603TI-ADJ	1603AT	-40 to +125	Yes	Adjustable	14 Ld HTSSOP	M14.173B
EVB-EY1603TI-ADJ	Evaluation Platform					

NOTES:

1. Add "-T*" suffix for tape and reel.
2. These Altera Enpirion Pb-free plastic packaged products employ special Pb-free material sets, molding compounds/die attach materials, and 100% matte tin plate plus anneal (e3 termination finish, which is RoHS compliant and compatible with both SnPb and Pb-free soldering operations). Altera Enpirion Pb-free products are MSL classified at Pb-free peak reflow temperatures that meet or exceed the Pb-free requirements of IPC/JEDEC J STD-020.

Pin Configuration

EY1603TI-ADJ (14 LD HTSSOP)

TOP VIEW

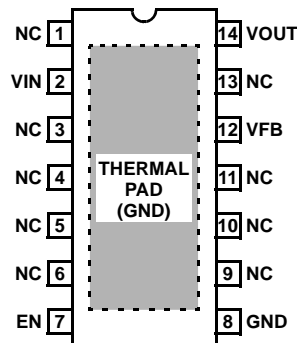

Pin Descriptions

PIN NUMBER	PIN NAME	DESCRIPTION
1, 3, 4, 5, 6, 9, 10, 11, 13	NC	Pins have internal termination and can be left unconnected. Connection to ground is optional.
2	VIN	Input voltage pin. A minimum 0.1µF ceramic capacitor is required for proper operation. Range 6V to 40V.
7	EN	Enable pin. High on this pin enables the device. Range 0V to V_{IN} .
8	GND	Ground pin.
12	VFB	This pin is connected to the external feedback resistor divider which sets the LDO output voltage. Range 0V to 3V.
14	VOUT	Regulated output voltage. A 10µF ceramic capacitor is required for stability. Range 0V to 12V.
-	EPAD	It is recommended to solder the EPAD to the ground plane.

Absolute Maximum Ratings

VIN Pin to GND Voltage	GND - 0.3V to +45V
VOU Pin to GND Voltage	GND - 0.3V to 16V
VFB Pin to GND Voltage	GND - 0.3V to 3V
EN Pin to GND Voltage	GND - 0.3V to VIN
Output Short-circuit Duration	Indefinite
ESD Rating	
Human Body Model (Tested per JESD22-A114E)	5kV
Machine Model (Tested per JESD-A115-A)	200V
Charge Device Model (Tested per JESD22-C101C)	2.2kV
Latch Up (Tested per JESD78B; Class II, Level A)	100mA

Thermal Information

Thermal Resistance (Typical)	θ_{JA} (°C/W)	θ_{JC} (°C/W)
14 Ld HTSSOP Package (Notes 3,4)	37	5
Maximum Junction Temperature	+150°C	
Maximum Storage Temperature Range	-65°C to +175°C	
Pb-Free Reflow Profile	—	

Recommended Operating Conditions

Ambient Temperature Range	-40°C to +125°C
VIN pin to GND Voltage	+6V to +40V
VOU pin to GND Voltage	+1.223V to +12V
EN pin to GND Voltage	.0V to +40V

CAUTION: Do not operate at or near the maximum ratings listed for extended periods of time. Exposure to such conditions may adversely impact product reliability and result in failures not covered by warranty.

NOTES:

- θ_{JA} is measured with the component mounted on a high effective thermal conductivity test board in free air.
- For θ_{JC} , the “case temp” location is the center of the exposed metal pad on the package underside.

Electrical Specifications Recommended Operating Conditions, unless otherwise noted. $V_{IN} = 14V$, $I_{OUT} = 1mA$, $C_{IN} = 0.1\mu F$, $C_{OUT} = 10\mu F$, $T_A = T_J = -40^\circ C$ to $+125^\circ C$, unless otherwise noted. Typical specifications are at $T_A = +25^\circ C$. **Boldface limits apply over the operating temperature range, -40°C to +125°C.**

PARAMETER	SYMBOL	TEST CONDITIONS	MIN (Note 7)	TYP	MAX (Note 7)	UNIT
Input Voltage Range	V_{IN}		6		40	V
Guaranteed Output Current	I_{OUT}	$V_{IN} = V_{OUT} + V_{DO}$	150			mA
VFB Reference Voltage	V_{OUT}	$\overline{EN} = \text{High}$, $V_{IN} = 14V$, $I_{OUT} = 0.1mA$ to $150mA$	1.211	1.223	1.235	V
Line Regulation	$\Delta V_{OUT}/\Delta V_{IN}$	$3V \leq V_{IN} \leq 40V$, $I_{OUT} = 1mA$		0.04	0.15	%
Load Regulation	$\Delta V_{OUT}/\Delta I_{OUT}$	$V_{IN} = V_{OUT} + V_{DO}$, $I_{OUT} = 100\mu A$ to $150mA$		0.3	0.6	%
Dropout Voltage (Note 5)	ΔV_{DO}	$I_{OUT} = 1mA$, $V_{OUT} = 3.3V$		7	33	mV
		$I_{OUT} = 150mA$, $V_{OUT} = 3.3V$		380	525	mV
		$I_{OUT} = 1mA$, $V_{OUT} = 5V$		7	33	mV
		$I_{OUT} = 150mA$, $V_{OUT} = 5V$		295	460	mV
Shutdown Current	I_{SHDN}	EN = LOW		2	3.64	μA
Quiescent Current	IQ	EN = HIGH, $I_{OUT} = 0mA$		18	24	μA
		EN = HIGH, $I_{OUT} = 1mA$		22	42	μA
		EN = HIGH, $I_{OUT} = 10mA$		34	60	μA
		EN = HIGH, $I_{OUT} = 150mA$		90	125	μA
Power Supply Rejection Ratio	PSRR	$f = 100Hz$; $V_{IN_RIPPLE} = 500mV_{P-P}$; Load = $150mA$		66		dB
EN FUNCTION						
\overline{EN} Threshold Voltage	V_{EN_H}	$V_{OUT} = \text{Off to On}$			1.485	V
	V_{EN_L}	$V_{OUT} = \text{On to Off}$	0.975			V
\overline{EN} Pin Current	I_{EN}	$V_{OUT} = 0V$		0.026		μA
\overline{EN} to Regulation Time (Note 6)	t_{EN}			1.65	1.93	ms

Electrical Specifications Recommended Operating Conditions, unless otherwise noted. $V_{IN} = 14V$, $I_{OUT} = 1mA$, $C_{IN} = 0.1\mu F$, $C_{OUT} = 10\mu F$, $T_A = T_J = -40^\circ C$ to $+125^\circ C$, unless otherwise noted. Typical specifications are at $T_A = +25^\circ C$. **Boldface limits apply over the operating temperature range, $-40^\circ C$ to $+125^\circ C$.** (Continued)

PARAMETER	SYMBOL	TEST CONDITIONS	MIN (Note 7)	TYP	MAX (Note 7)	UNIT
PROTECTION FEATURES						
Output Current Limit	I_{LIMIT}	$V_{OUT} = 0V$	175	410		mA
Thermal Shutdown	T_{SHDN}	Junction Temperature Rising		+165		$^\circ C$
Thermal Shutdown Hysteresis	T_{HYST}			+20		$^\circ C$

NOTES:

- Dropout voltage is defined as $(V_{IN} - V_{OUT})$ when V_{OUT} is 2% below the value of V_{OUT} when $V_{IN} = V_{OUT} + 3V$.
- Enable to Regulation is the time the output takes to reach 95% of its final value with $V_{IN} = 14V$ and \overline{EN} is taken from V_{IL} to V_{IH} in 5ns. For the adjustable versions, the output voltage is set at 5V.
- Parameters with MIN and/or MAX limits are 100% tested at $+25^\circ C$, unless otherwise specified. Temperature limits established by characterization and are not production tested.

Typical Performance Curves $V_{IN} = 14V, I_{OUT} = 1mA, V_{OUT} = 5V, T_J = +25^{\circ}C$, unless otherwise specified.

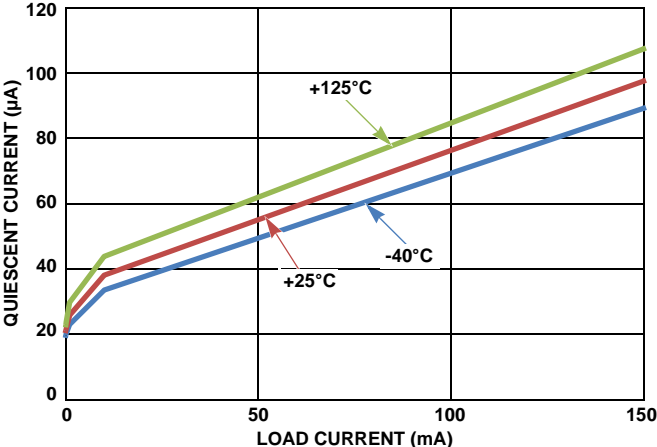

FIGURE 3. QUIESCENT CURRENT vs LOAD CURRENT

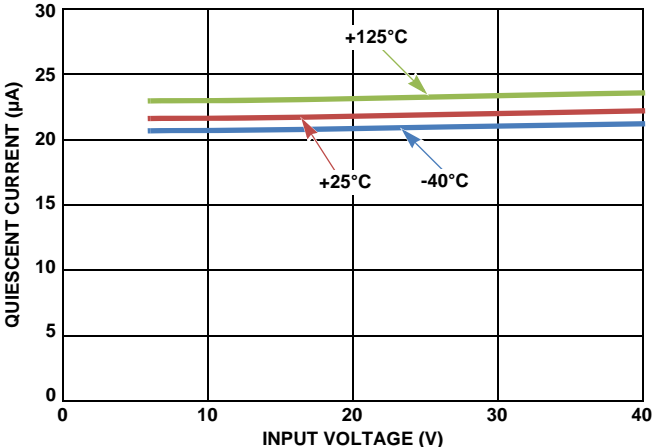

FIGURE 4. QUIESCENT CURRENT vs INPUT VOLTAGE (NO LOAD)

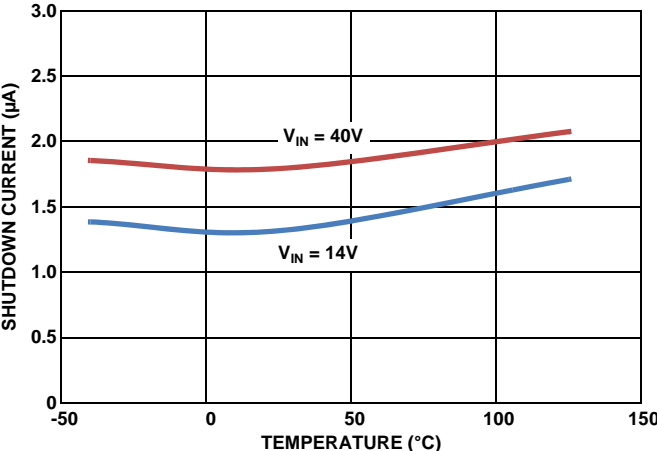

FIGURE 5. SHUTDOWN CURRENT vs TEMPERATURE (EN = 0)

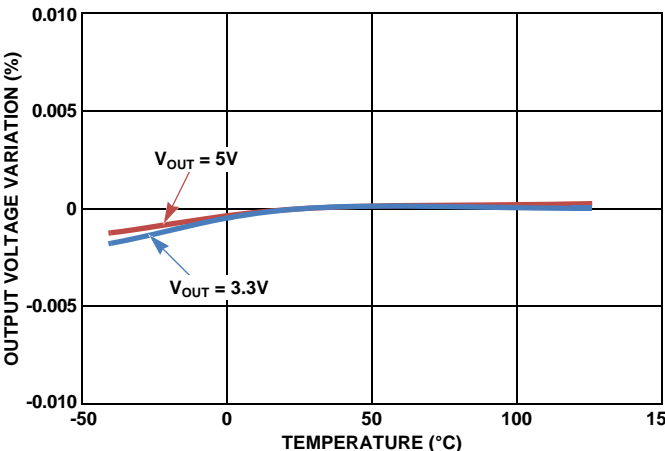

FIGURE 6. OUTPUT VOLTAGE vs TEMPERATURE (LOAD = 50mA)

Typical Performance Curves $V_{IN} = 14V, I_{OUT} = 1mA, V_{OUT} = 5V, T_J = +25^{\circ}C$, unless otherwise specified. (Continued)

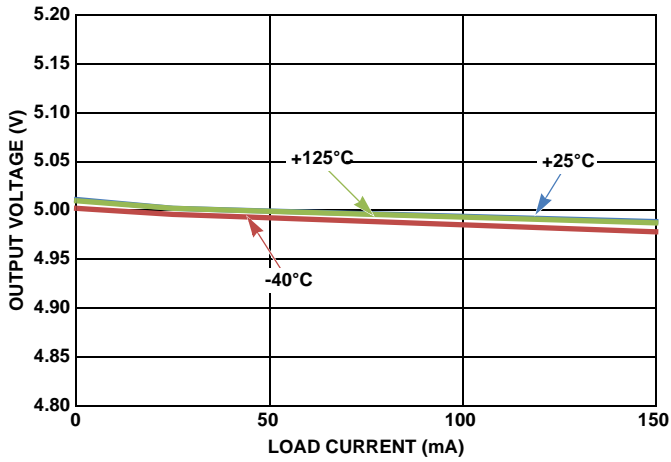

FIGURE 7. OUTPUT VOLTAGE vs LOAD CURRENT

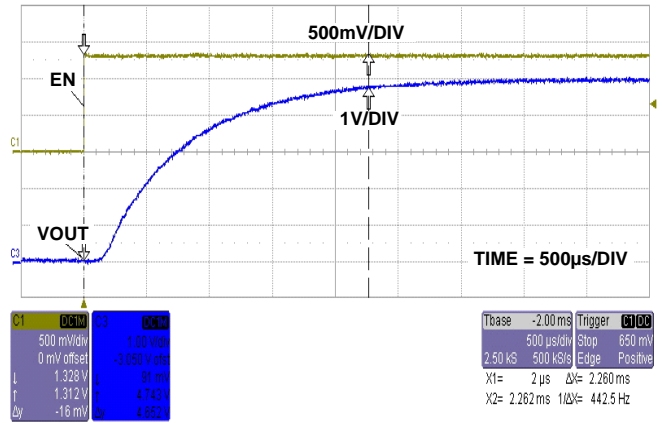

FIGURE 8. START-UP WAVEFORM

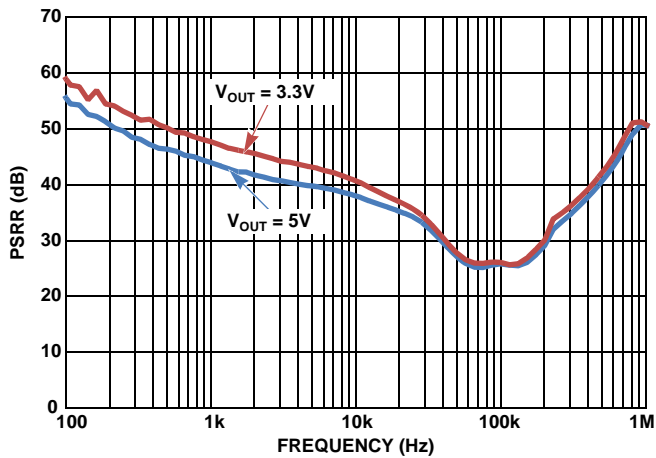

FIGURE 9. POWER SUPPLY REJECTION RATIO (LOAD = 150mA)

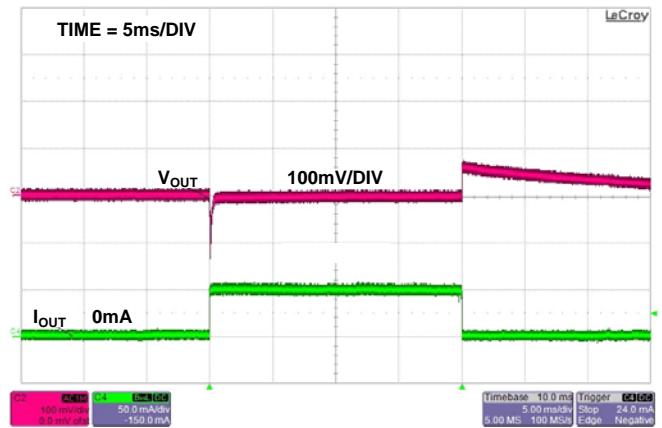
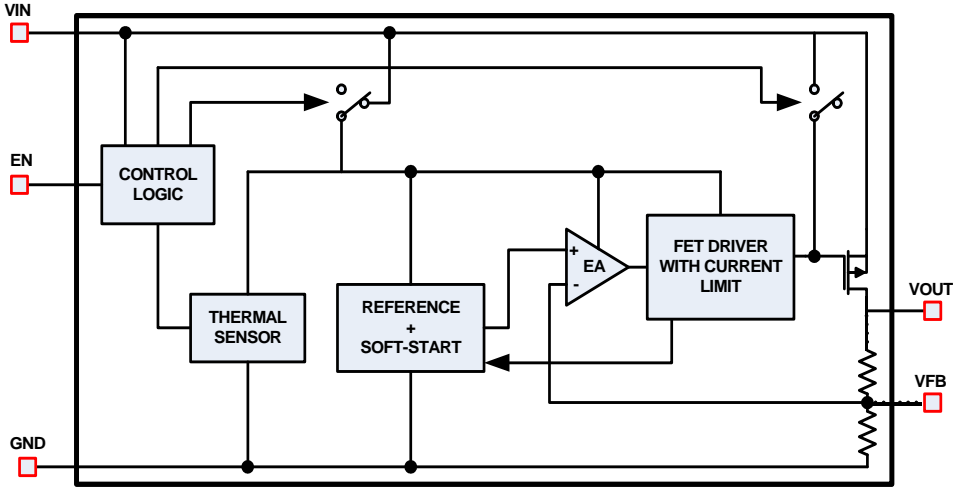

FIGURE 10. LOAD TRANSIENT RESPONSE

Block Diagram



Functional Description

Functional Overview

The EY1603 is a high performance, high voltage, low-dropout regulator (LDO) with 150mA sourcing capability. The part is rated to operate over the -40°C to +125°C temperature range. Featuring ultra-low quiescent current, it is an ideal choice for “always-on” applications. It works well under a “load dump condition” where the input voltage could rise up to 40V. This LDO device also features current limit and thermal shutdown protection.

Enable Control

The EY1603 has an enable pin, which turns the device on when pulled high. When EN is low, the IC goes into shutdown mode and draws less than 2µA. In “always-on” applications, EN can be tied to IN.

Current Limit Protection

The EY1603 has internal current limiting functionality to protect the regulator during fault conditions. During current limit, the output sources a fixed amount of current largely independent of the output voltage. If the short or overload is removed from V_{OUT} , the output returns to normal voltage regulation mode.

Thermal Fault Protection

In the event that the die temperature exceeds a typical value of +165°C, the output of the LDO will shut down until the die temperature cools down to a typical +145°C. The level of power dissipated, combined with the ambient temperature and the thermal impedance of the package, determines if the junction temperature exceeds the thermal shutdown temperature. See the “Power Dissipation” section on page 8 for more details.

Application Information

Input and Output Capacitors

A minimum 0.1µF ceramic capacitor is recommended at the input for proper operation. For the output, a ceramic capacitor with a capacitance of 10µF is recommended for the EY1603 to maintain stability. The ground connection of the output capacitor should be routed directly to the GND pin of the device and also placed close to the IC.

Output Voltage Setting

The EY1603TI-ADJ output voltage is programmed using an external resistor divider as shown in Figure 11.

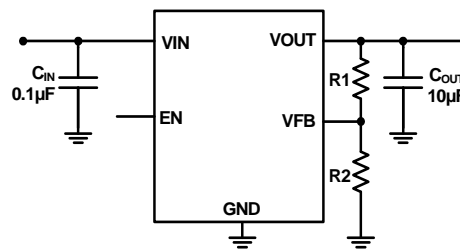

FIGURE 11. OUTPUT VOLTAGE SETTING

The output voltage is calculated using Equation 1:

$$V_{OUT} = 1.223V \times \left(\frac{R_1}{R_2} + 1 \right) \quad (\text{EQ. 1})$$

Power Dissipation

The junction temperature must not exceed the range specified in “Recommended Operating Conditions” on page 3. The power dissipation can be calculated using Equation 2:

The maximum allowable junction temperature, $T_{J(\text{MAX})}$ and the maximum expected ambient temperature, $T_{A(\text{MAX})}$ will determine the maximum allowable junction temperature rise (ΔT_J), as shown in Equation 2:

$$\Delta T_J = T_{J(\text{MAX})} - T_{A(\text{MAX})} \quad (\text{EQ. 2})$$

To calculate the maximum ambient operating temperature, use the junction-to-ambient thermal resistance (θ_{JA}) as shown in Equation 3:

$$T_{J(MAX)} = P_{D(MAX)} \times \theta_{JA} + T_A \quad (\text{EQ. 3})$$

Board Layout Recommendations

A good PCB layout is important to achieve expected performance. Consideration should be taken when placing the components and routing the trace to minimize the ground impedance and keep the parasitic inductance low. The input and output capacitors should have a good ground connection and be placed as close to the IC as possible. The feedback trace in the adjustable version should be away from other noisy traces.

The 14 Ld HTSSOP package uses the copper area on the PCB as a heat-sink. The EPAD of this package must be soldered to the copper plane (GND plane) for effective heat dissipation. Figure 12 shows a curve for θ_{JA} of the package for different copper area sizes.

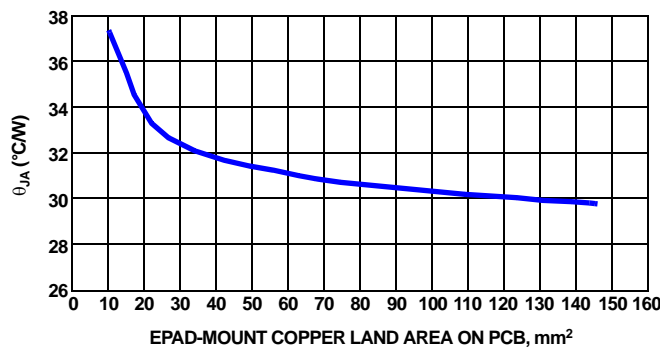

FIGURE 12. θ_{JA} vs EPAD-MOUNT COPPER LAND AREA ON PCB

Document Revision History

The table lists the revision history for this document.

Date	Version	Changes
April 2019	C	Added NRND.
June 2015	B	Updated the output voltage range.
February 2014	A	Initial release.

209

Package Outline Drawing

M14.173B

14 LEAD HEAT-SINK THIN SHRINK SMALL OUTLINE PACKAGE (HTSSOP)

Rev 1, 1/10

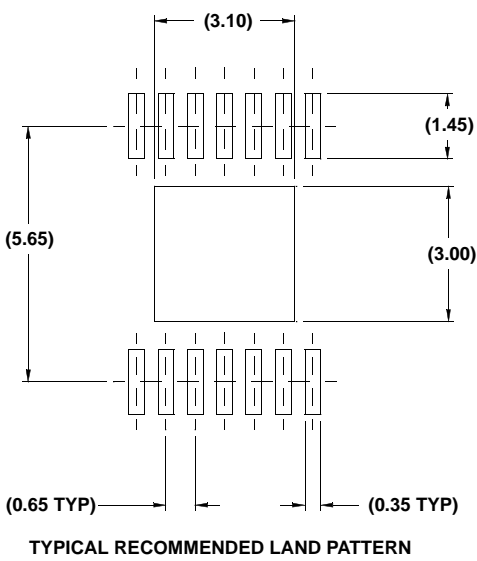
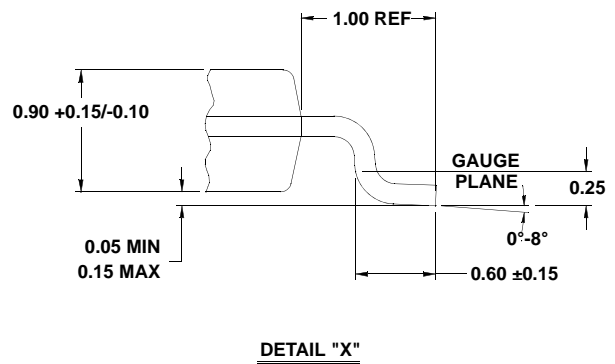
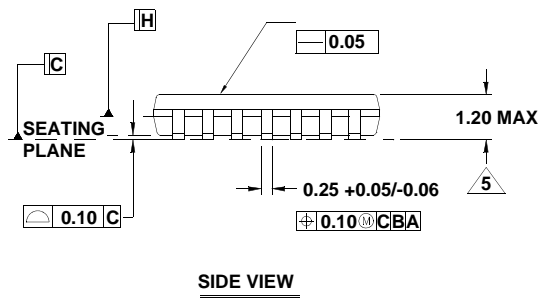
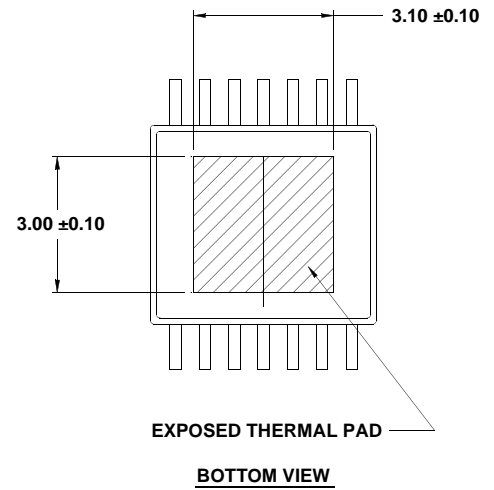
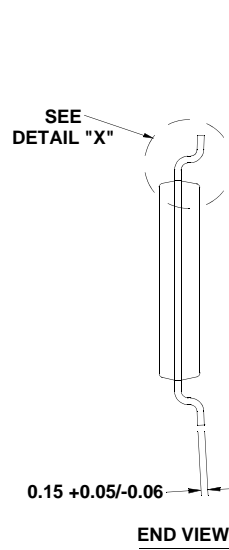
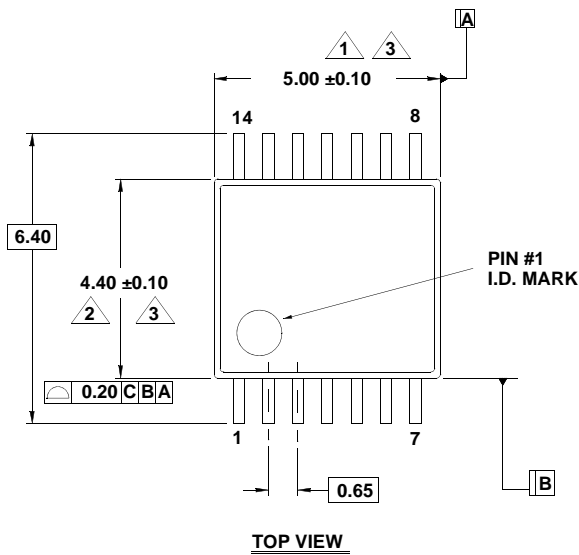

NOTES:

1. Dimension does not include mold flash, protrusions or gate burrs. Mold flash, protrusions or gate burrs shall not exceed 0.15 per side.
2. Dimension does not include interlead flash or protrusion. Interlead flash or protrusion shall not exceed 0.25 per side.
3. Dimensions are measured at datum plane H.
4. Dimensioning and tolerancing per ASME Y14.5M-1994.
5. Dimension does not include dambar protrusion. Allowable protrusion shall be 0.80mm total in excess of dimension at maximum material condition. Minimum space between protrusion and adjacent lead is 0.07mm.
6. Dimension in () are for reference only.
7. Conforms to JEDEC MO-153, variation ABT-1.

X-ON Electronics

Largest Supplier of Electrical and Electronic Components

Click to view similar products for [Switching Voltage Regulators](#) category:

Click to view products by [Intel](#) manufacturer:

Other Similar products are found below :

[FAN53610AUC33X](#) [FAN53611AUC123X](#) [FAN48610BUC33X](#) [FAN48610BUC45X](#) [FAN48617UC50X](#) [R3](#) [430464BB](#) [KE177614](#)
[FAN53611AUC12X](#) [MAX809TTR](#) [NCV891234MW50R2G](#) [NCP81103MNTXG](#) [NCP81203PMNTXG](#) [NCP81208MNTXG](#)
[NCP81109GMNTXG](#) [SCY1751FCCT1G](#) [NCP81109JMNTXG](#) [AP3409ADNTR-G1](#) [NCP81241MNTXG](#) [LTM8064IY](#) [LT8315EFE#TRPBF](#)
[LTM4664EY#PBF](#) [LTM4668AIY#PBF](#) [NCV1077CSTBT3G](#) [XCL207A123CR-G](#) [MPM54304GMN-0002](#) [MPM54304GMN-0004](#)
[MPM54304GMN-0003](#) [AP62300Z6-7](#) [MP8757GL-P](#) [MIC23356YFT-TR](#) [LD8116CGL](#) [HG2269M/TR](#) [OB2269](#) [XD3526](#) [U6215A](#) [U6215B](#)
[U6620S](#) [LTC3412IFE](#) [LT1425IS](#) [MAX25203BATJA/VY+](#) [MAX77874CEWM+](#) [XC9236D08CER-G](#) [MP3416GJ-P](#) [BD9S201NUX-CE2](#)
[MP5461GC-Z](#) [MPQ4415AGQB-Z](#) [MPQ4590GS-Z](#) [MAX38640BENT18+T](#) [MAX77511AEWB+](#)