



MOBILE PENTIUM® II PROCESSOR IN Micro-PGA AND BGA PACKAGES AT 400 MHz, 366 MHz, 333 MHz, 300PE MHz, AND 266PE MHz

- + Available at 400 MHz, 366 MHz, 333 MHz, 300PE MHz, and 266PE MHz
- + Supports the Intel Architecture with Dynamic Execution
- + Integrated primary 16-Kbyte instruction cache and 16-Kbyte write back data cache
- + Integrated second level cache (256-Kbyte)
- + Micro-PGA and BGA packaging technologies
 - Supports thin form factor notebook designs
 - Exposed die enables more efficient heat dissipation
- + Fully compatible with previous Intel microprocessors
 - Binary compatible with all applications
 - Support for MMX™ technology
- + Power Management Features
 - Quick Start and Deep Sleep modes provide extremely low power dissipation
- + Low-Power GTL+ processor system bus interface
- + Integrated math co-processor
- + Integrated thermal diode

The Intel® Mobile Pentium® II processor introduces a higher level of performance for today's mobile computing environment, including multimedia enhancements and improved Internet and communications capabilities. It provides an improved performance¹ available for applications running on advanced operating systems such as Windows* 98. On top of its built-in power management capabilities, the Pentium II processor takes advantage of software designed for Intel's MMX™ technology to unleash enhanced color, smoother graphics and other multimedia and communications enhancements.

The Mobile Pentium® II processor may contain design defects or errors know as errata that may cause the product to deviate from published specifications. Current characterized errata are available upon request.



1. Refer to the *Mobile Pentium® II Processor Performance Brief*.

**MOBILE PENTIUM® II PROCESSOR IN MICRO-PGA AND BGA PACKAGES
AT 400 MHZ, 366 MHZ, 333 MHZ, 300PE MHZ, AND 266PE MHZ**



Information in this document is provided in connection with Intel products. No license, express or implied, by estoppel or otherwise, to any intellectual property rights is granted by this document or by the sale of Intel products. Except as provided in Intel's terms and conditions of sale for such products, Intel assumes no liability whatsoever, and Intel disclaims any express or implied warranty, relating to sale and/or use of Intel products including liability or warranties relating to fitness for a particular purpose, merchantability, or infringement of any patent, copyright or other intellectual property right. Intel products are not intended for use in medical, life saving or life sustaining applications.

Intel retains the right to make changes to specifications and product descriptions at any time, without notice.

Designers must not rely on the absence or characteristics of any features or instructions marked "reserved" or "undefined." Intel reserves these for future definition and shall have no responsibility whatsoever for conflicts or incompatibilities arising from future changes to them.

The Mobile Pentium® II processor may contain design defects or errors known as errata which may cause the product to deviate from published specifications. Current characterized errata are available on request.

Contact your local Intel sales office or your distributor to obtain the latest specifications and before placing your product order.

Copies of documents which have an order number and are referenced in this document, or other Intel literature, may be obtained by calling 1-800-548-4725 or by visiting Intel's website at <http://www.intel.com>

Copyright © Intel Corporation, 1999.

*Third-party brands and names are the property of their respective owners.



CONTENTS

	PAGE		PAGE
1. INTRODUCTION	1	3.4 Maximum Ratings	16
1.1 Overview	2	3.5 DC Specifications	18
1.2 Terminology	2	3.6 AC Specifications	23
1.3 References	2	3.6.1 System Bus, Clock, APIC, TAP, CMOS and Open-Drain AC Specifications	23
2. MOBILE PENTIUM® II PROCESSOR FEATURES	4	4. SYSTEM SIGNAL SIMULATIONS	37
2.1 Feature Differences between the Mobile Pentium® II Processor at 400 MHz and Mobile Pentium® II Processor at 366 MHz and below	4	4.1 System Bus Clock (BCLK) Signal Quality Specifications	37
2.2 Power Management	4	4.2 Low Power GTL+ Signal Quality Specifications	38
2.2.1 Clock Control Architecture	4	4.3 Non-Low Power GTL+ Signal Quality Specifications	41
2.2.2 Normal State	6	4.3.1 Overshoot and Undershoot Guidelines	42
2.2.3 Auto Halt State	6	4.3.1 Ringback Specification	43
2.2.4 STOP GRANT State	6	4.3.2 Settling Limit Guideline	43
2.2.5 QUICK START State	6	5. MECHANICAL SPECIFICATIONS	44
2.2.6 HALT/GRANT SNOOP State	7	5.1 Dimensions of the Micro-PGA Package ...	44
2.2.7 SLEEP State	8	5.2 Dimensions of the BGA Package	46
2.2.8 Deep Sleep State	8	5.3 Signal Listings	49
2.2.9 Operating System Implications of Quick Start and Sleep States	8	6. THERMAL SPECIFICATIONS	62
2.3 Low Power GTL+	8	6.1 Thermal Diode	63
2.3.1 GTL+ Signals	9	6.2 Case Temperature	64
2.4 Mobile Pentium® II Processor CPUID	9	7. PROCESSOR INITIALIZATION AND CONFIGURATION	65
3. ELECTRICAL SPECIFICATIONS	11	7.1 Description	65
3.1 Processor System Signals	11	7.1.1 Quick Start Enable	65
3.1.1 Power Sequencing Requirements ...	12	7.1.2 System Bus Frequency	65
3.1.2 Test Access Port (TAP) Connection	13	7.1.3 APIC Disable	65
3.1.3 Catastrophic Thermal Protection	13	7.2 Clock Frequencies and Ratios	65
3.1.4 Unused Signals	13	8. PROCESSOR INTERFACE	66
3.1.5 Signal State in Low Power States ...	13	8.1 Alphabetical Signal Reference	66
3.2 Power Supply Requirements	14	8.2 Signal Summaries	72
3.2.1 Decoupling Recommendations	14		
3.2.2 Voltage Planes	14		
3.3 System Bus Clock and Processor Clocking	15		



LIST OF FIGURES

	PAGE
Figure 1.1 Signal Groups of a Mobile Pentium® II Processor-Based System	1
Figure 2.1 Clock Control States	5
Figure 3.1 Ramp Rate Requirement	13
Figure 3.2 PLL LC Filter	14
Figure 3.3 Generic Clock Waveform.....	30
Figure 3.4 Valid Delay Timings.....	31
Figure 3.5 Setup and Hold Timings	31
Figure 3.6 Reset and Configuration Timings.....	32
Figure 3.7 Power-On Reset Timings.....	33
Figure 3.8 Test Timings (Boundary Scan)	34
Figure 3.9 Test Reset Timings.....	34
Figure 3.10 Quick Start/Deep Sleep Timing.....	35
Figure 3.11 Stop Grant/Sleep/Deep Sleep Timing	36
Figure 4.1 BCLK Generic Clock Waveform	38
Figure 4.2 GTL+ Receiver Ringback Tolerance	39
Figure 4.3 Maximum Acceptable GTL+ Overshoot/Undershoot Waveform for the Mobile Pentium® II Processor at 400 MHz	41
Figure 4.4 Non-GTL+ Signal Ringback and Settling Limit.....	42
Figure 5.1 Micro-PGA Package-Top and Side View.....	45
Figure 5.2 Micro-PGA Package - Bottom View	46
Figure 5.3 Surface-Mount BGA Package - Top and Side View.....	48
Figure 5.4 Surface-Mount BGA Package - Bottom View.....	49
Figure 5.5 Pin/Ball Map - Top View	50
Figure 6.1 Technique for Measuring Case Temperature	64
Figure 8.1 PWRGOOD Relationship at Power-On	70



LIST OF TABLES

	PAGE		PAGE
Table 2.1	VTOL, CMOS and Open Drain Signal Characteristics.....	4	
Table 2.2	Clock State Characteristics.....	7	
Table 2.3	Mobile Pentium® II Processor CPUID	9	
Table 2.4	Mobile Pentium® II Processor CPUID Cache and TLB Descriptors.....	9	
Table 3.1	System Signal Groups.....	11	
Table 3.2	Recommended Resistors for Open Drain Signals.....	12	
Table 3.3	LC Filter Specifications.....	15	
Table 3.4	Core Frequency to System Bus Ratio Configuration.....	15	
Table 3.5	Absolute Maximum Ratings for Mobile Pentium® II Processor at 400 MHz	16	
Table 3.6	Absolute Maximum Ratings for Mobile Pentium® II Processor at 366 MHz and Below.....	17	
Table 3.7	Power Specifications for Mobile Pentium® II Processor at 400 MHz.....	18	
Table 3.8	Power Specifications for Mobile Pentium® II Processor at 366 MHz and Below.....	19	
Table 3.9	Power Specifications for Low Voltage Pentium® II Processor.....	20	
Table 3.10	Low Power GTL+ Signal Group DC Specifications.....	21	
Table 3.11	Low Power GTL+ Bus DC Specifications.....	21	
Table 3.12	Clock, APIC, TAP, CMOS and Open-Drain Signal Group DC Specifications for the Mobile Pentium® II Processor at 400 MHz.....	22	
Table 3.13	Clock, APIC, TAP, CMOS and Open-Drain Signal Group DC Specifications for the Mobile Pentium® II Processor at 366 MHz and Below.....	23	
Table 3.14	System Bus Clock AC Specifications.	24	
Table 3.15	Valid Mobile Pentium® II Processor Frequencies.....	25	
Table 3.16	Low Power GTL+ Signal Groups AC Specifications.....	25	
Table 3.17	CMOS and Open-Drain Signal Groups AC Specifications.....	26	
Table 3.18	Reset Configuration AC Specifications	27	
Table 3.19	TAP Signal AC Specifications.....	28	
Table 3.20	Quick Start/Deep Sleep AC Specifications.....	29	
Table 3.21	Stop Grant/Sleep/Deep Sleep AC Specifications.....	29	
Table 4.1	BCLK Signal Quality Specifications.....	37	
Table 4.2	Low Power GTL+ Signal Group Ringback Specification for the Mobile Pentium® II Processor.....	39	
Table 4.3	GTL+ Signal Group Overshoot/Undershoot Tolerance at the Processor Core for the Mobile Pentium® II Processor at 400 MHz.....	40	
Table 4.4	Signal Ringback Specifications for Non-GTL+ Signals for the Mobile Pentium® II Processor at 400 MHz.....	43	
Table 4.5	Signal Ringback Specifications for Non-GTL+ Signals for the Mobile Pentium® II Processor at 366 MHz and Below ...	43	
Table 5.1	Micro-PGA Package Mechanical Specifications.....	44	
Table 5.2	Surface-Mount BGA Package Specifications.....	47	
Table 5.3	Signal Listing in Order by Pin/Ball Number.....	51	
Table 5.4	Signal Listing in Order by Signal Name	57	
Table 5.5	Voltage and No-Connect Ball/Pin Locations.....	61	
Table 6.1	Mobile Pentium®II Processor (0.18µm) Power Specifications.....	62	
Table 6.2	Thermal Diode Interface.....	63	
Table 6.3	Thermal Diode Specifications.....	63	
Table 8.1	Input Signals.....	73	
Table 8.2	Output Signals.....	74	
Table 8.3	Input/Output Signals (Single Driver).....	74	
Table 8.4	Input/Output Signals (Multiple Driver)...	75	



**MOBILE PENTIUM® II PROCESSOR IN MICRO-PGA AND BGA PACKAGES
AT 400 MHZ, 366 MHZ, 333 MHZ, 300PE MHZ, AND 266PE MHZ**

1. INTRODUCTION

The Mobile Pentium® II processor is now offered at 400 MHz, 366 MHz, 333 MHz, 300PE MHz, and 266PE MHz, with a system bus speed of 66 MHz. The Mobile Pentium® II processor at 400 MHz in Micro-PGA and BGA packages are the first mobile processors manufactured in 0.18µm technology. Processors at frequencies 366 MHz and below are manufactured in 0.25µm processing technology. The Mobile Pentium® II processor consists of a processor core with an integrated L2 cache and a

64-bit high performance system bus. The integrated L2 cache is designed to help improve performance; it complements the system bus by providing critical data faster and reducing total system power consumption. The Mobile Pentium® II processor's 64-bit wide Low Power Gunning Transceiver Logic (GTL+) system bus is compatible with the 440BX AGPSet and provides a glue-less, point-to-point interface for an I/O bridge/memory controller. Figure 1.1 shows the various parts of a Mobile Pentium II processor-based system and how the Mobile Pentium II processor connects to them.

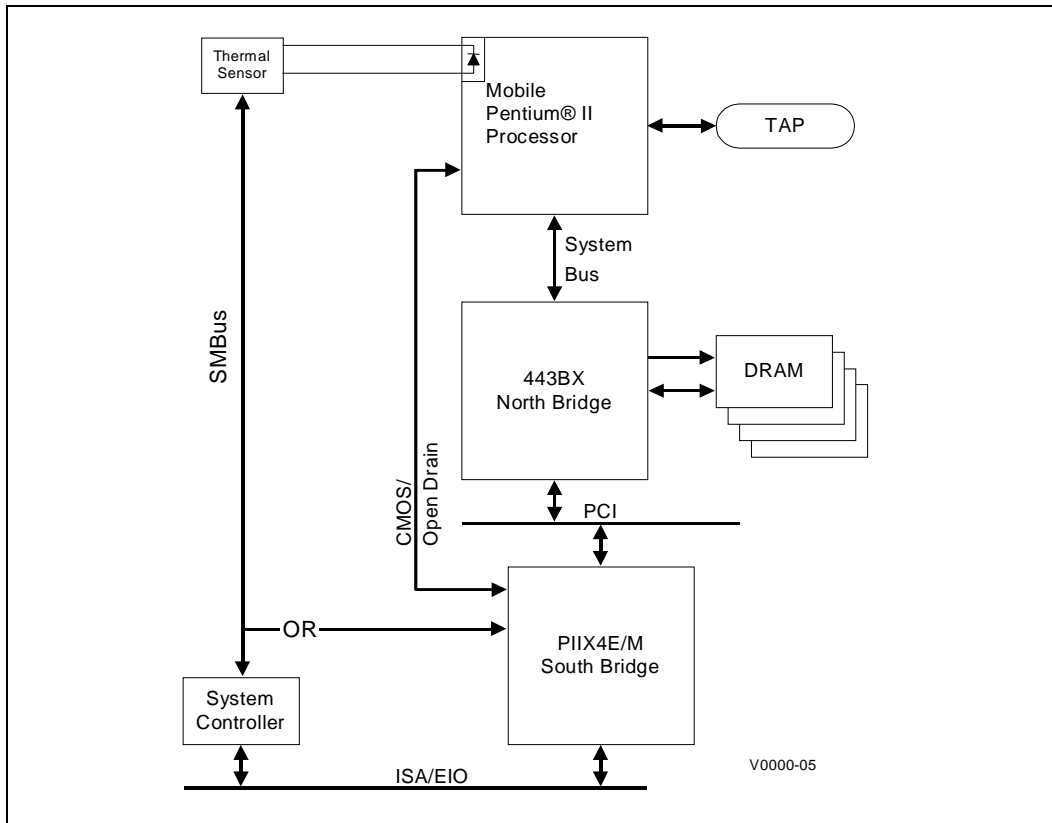

Figure 1.1 Signal Groups of a Mobile Pentium® II Processor-Based System



1.1 Overview

- Performance improved over existing mobile processors
 - Supports the Intel Architecture with Dynamic Execution
 - Supports the Intel Architecture MMX™ technology
 - Integrated Intel Floating-Point Unit compatible with the IEEE 754 standard
- Integrated primary (L1) instruction and data caches
 - 4-way set associative, 32-byte line size, 1 line per sector
 - 16-Kbyte instruction cache and 16-Kbyte writeback data cache
 - Cacheable range programmable by processor programmable registers
- Integrated second level (L2) cache
 - 4-way set associative, 32-byte line size, 1 line per sector
 - Operates at full core speed
 - 256-Kbyte, ECC protected cache data array
 - 4 Gbyte cacheable range
- Low Power GTL+ system bus interface
 - 64-bit data bus, 66-MHz operation
 - Uniprocessor, two loads only (processor and I/O bridge/memory controller)
 - Short trace length and low capacitance allows for single ended termination
- Voltage reduction technology
- Advanced processor clock control
 - Quick Start for low power, low exit latency clock “throttling”
 - Deep Sleep mode for extremely low power dissipation
- Thermal diode for measuring processor temperature

1.2 Terminology

In this document a ‘#’ symbol following a signal name indicates that the signal is active low. This means that when the signal is asserted (based on

the name of the signal) it is in an electrical low state. Otherwise, signals are driven in an electrical high state when they are asserted. In state machine diagrams, a signal name in a condition indicates the condition of that signal being asserted. If the signal name is preceded by a ‘!’ symbol, then it indicates the condition of that signal not being asserted. For example, the condition ‘!STPCLK# and HS’ is equivalent to ‘the active low signal STPCLK# is unasserted (i.e., it is at 1.5V for the 400 MHz, and 2.5V for the 366 MHz and below) and the HS condition is true.’ The symbols ‘L’ and ‘H’ refer respectively to electrical low and electrical high signal levels. The symbols ‘0’ and ‘1’ refer respectively to logical low and logical high signal levels. For example, BD[3:0] = ‘1010’ = ‘HLHL’ refers to a hexadecimal ‘A’, and D[3:0]# = ‘1010’ = ‘LHLH’ also refers to a hexadecimal ‘A’.

1.3 References

Pentium® II Processor at 233 MHz, 266 MHz, 300 MHz and 333 MHz (Order Number 243335)

Pentium® II Processor Developer's Manual (Order Number 243502)

CKDM66-M Clock Driver Specification (Contact your Intel Field Sales Representative)

CK97 Clock Driver Specification (Contact your Intel Field Sales Representative)

Intel Architecture Software Developer's Manual (Order Number 243193)

Volume I: Basic Architecture (Order Number 243190)

Volume II: Instruction Set Reference (Order Number 243191)

Volume III: System Programming Guide (Order Number 243192)

Mobile Pentium II Processor (0.18µm)/I/O Buffer Models, IBIS Format (Available in electronic form; contact your Intel Field Sales Representative)

Mobile Pentium® II Processor System Bus Layout Guideline (Order Number 243672-001)



**MOBILE PENTIUM® II PROCESSOR IN MICRO-PGA AND BGA PACKAGES
AT 400 MHZ, 366 MHZ, 333 MHZ, 300PE MHZ, AND 266PE MHZ**

*Mobile Pentium® II Processor Mechanical and
Thermal Design Guide (Order Number 243671-001)*



2. MOBILE PENTIUM® II PROCESSOR FEATURES

2.1 Feature Differences between the Mobile Pentium® II Processor at 400 MHz and Mobile Pentium® II Processor at 366 MHz and below

- Power specifications
- CPUID
- CMOS/Open Drain signal voltage tolerance
- Pull-up/pull-down recommendation for almost all signals
- CMOS signal DC specifications
- CMOS signal AC specifications
- VTOL pin impedance
- Core voltages, V_{CC} and V_{CCP}

Table 2.1 VTOL, CMOS and Open Drain Signal Characteristics

Mobile Pentium® II Processor	VTOL Pin	CMOS/Open Drain Signal Voltage Tolerance (V_{CMOS})	CMOS/Open Drain Signal Trip Voltage (V_{TRIP})
400 MHz	Short to Vss	1.5V	0.75V
366 MHz and below	High Impedance	2.5V	1.25V

2.2 Power Management

2.2.1 Clock Control Architecture

The Mobile Pentium® II processor clock control architecture (Figure 2.1) has been optimized for leading edge “Deep Green” desktop and mobile computer designs.

The Auto Halt state provides a low power clock state that can be controlled through the software execution of the HLT instruction. The Quick Start state provides a very low power, low exit latency clock state that can be used for hardware controlled “idle” computer states. The Deep Sleep state provides an extremely low power state that can be used for “Power-on Suspend” computer states, which is an alternative to shutting off the processor’s power. Compared to the Pentium processor exit latency of 1 msec, the exit latency of the Deep Sleep state has been reduced to 30 μ sec in the Mobile Pentium II processor. The Stop Grant and Sleep states shown in Figure 2.1 are intended for use in “Deep Green” desktop and server systems —

not in mobile systems. Performing state transitions not shown in Figure 2.1 is neither recommended nor supported.

The clock control architecture consists of seven different clock states: Normal, Auto Halt, Stop Grant, Quick Start, HALT/Grant Snoop, Sleep and Deep Sleep states. The Stop Grant and Quick Start clock states are mutually exclusive, i.e., a strapping option on signal A15# chooses which state is entered when the STPCLK# signal is asserted. Strapping the A15# signal to ground at Reset enables the Quick Start state; otherwise, asserting the STPCLK# signal puts the processor into the Stop Grant state. The Stop Grant state has a higher power level than the Quick Start state and is designed for SMP platforms. The Quick Start state has a much lower power level, but it can only be used in uniprocessor platforms. Table 2.2 provides clock state characteristics (power numbers based on estimates for a Mobile Pentium II processor at 400 MHz and 366 MHz), which are described in detail in the following sections.



**MOBILE PENTIUM® II PROCESSOR IN MICRO-PGA AND BGA PACKAGES
AT 400 MHZ, 366 MHZ, 333 MHZ, 300PE MHZ, AND 266PE MHZ**

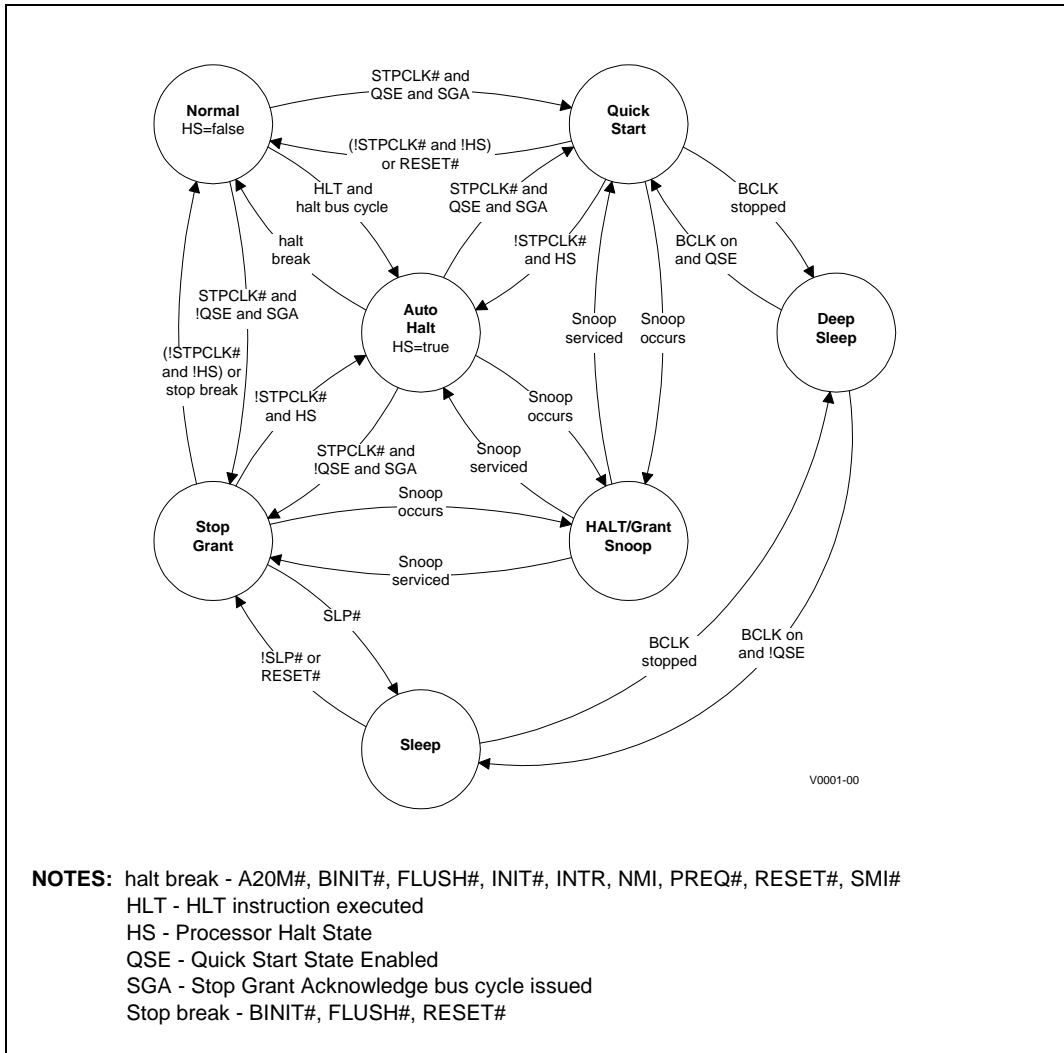

Figure 2.1 Clock Control States



2.2.2 Normal State

The Normal state of the processor is the normal operating mode where the processor's internal clock is running and the processor is actively executing instructions.

2.2.3 Auto Halt State

This is a low power mode entered by the processor through the execution of the HLT instruction. The power level of this mode is similar to the Stop Grant state. A transition to the Normal state is made by a halt break event (one of the following signals going active: NMI, INTR, BINIT#, INIT#, RESET#, FLUSH# or SMI#).

Asserting the STPCLK# signal while in the Auto Halt state will cause the processor to transition to the Stop Grant or Quick Start state, where a Stop Grant Acknowledge bus cycle will be issued. Deasserting STPCLK# will cause the processor to return to the Auto Halt state without issuing a new Halt bus cycle.

The SMI# interrupt is recognized in the Auto Halt state. The return from the System Management Interrupt (SMI) handler can be to either the Normal state or the Auto Halt state. See the *Intel® Architecture Software Developer's Manual, Volume III: System Programmer's Guide* for more information. No Halt bus cycle is issued when returning to the Auto Halt state from System Management Mode (SMM).

The FLUSH# signal is serviced in the Auto Halt state. After the on-chip and off-chip caches have been flushed, the processor will return to the Auto Halt state without issuing a Halt bus cycle. Transitions in the A20M# and PREQ# signals are recognized while in the Auto Halt state.

2.2.4 STOP GRANT State

The processor enters this mode with the assertion of the STPCLK# signal when it is configured for Stop Grant state (via the A15# strapping option). The processor is still able to respond to snoop requests and latch interrupts. Latched interrupts will

be serviced when the processor returns to the Normal state. Only one occurrence of each interrupt event will be latched. A transition back to the Normal state can be made by the de-assertion of the STPCLK# signal, or the occurrence of a stop break event (a BINIT#, FLUSH# or RESET# assertion).

The processor will return to the Stop Grant state after the completion of a BINIT# bus initialization unless STPCLK# has been de-asserted. RESET# assertion will cause the processor to immediately initialize itself, but the processor will stay in the Stop Grant state after initialization until STPCLK# is deasserted. If the FLUSH# signal is asserted, the processor will flush the on-chip caches and return to the Stop Grant state. A transition to the Sleep state can be made by the assertion of the SLP# signal.

While in the Stop Grant state, assertions of SMI#, INIT#, INTR and NMI will be latched by the processor. These latched events will not be serviced until the processor returns to the Normal state. Only one of each event will be recognized upon return to the Normal state.

2.2.5 QUICK START State

This is a mode entered by the processor with the assertion of the STPCLK# signal when it is configured for the Quick Start state (via the A15# strapping option). In the Quick Start state the processor is only capable of acting on snoop transactions generated by the system bus priority device. Because of its snooping behavior, Quick Start can only be used in a Uniprocessor (UP) configuration.

A transition to the Deep Sleep state can be made by stopping the clock input to the processor. A transition back to the Normal state (from the Quick Start state) is made only if the STPCLK# signal is deasserted.

While in this state the processor is limited in its ability to respond to input. It is incapable of latching any interrupts, servicing snoop transactions from symmetric bus masters or responding to FLUSH# or



**MOBILE PENTIUM® II PROCESSOR IN MICRO-PGA AND BGA PACKAGES
AT 400 MHZ, 366 MHZ, 333 MHZ, 300PE MHZ, AND 266PE MHZ**

BINIT# assertions. While the processor is in the Quick Start state, it will not respond properly to any input signal other than STPCLK#, RESET# or BPRI#. If any other input signal changes, then the behavior of the processor will be unpredictable. No serial interrupt messages may begin or be in

progress while the processor is in the Quick Start state.

RESET# assertion will cause the processor to immediately initialize itself, but the processor will stay in the Quick Start state after initialization until STPCLK# is deasserted.

Table 2.2 Clock State Characteristics

Clock State	Exit Latency	Power	Snooping?	System Uses
Normal	N/A	Varies	Yes	Normal program execution
Auto Halt	Approximately 10 bus clocks	1.25 W	Yes	S/W controlled entry idle mode
Stop Grant	Approximately 10 bus clocks	1.25 W	Yes	H/W controlled entry/exit mobile throttling
Quick Start	Through snoop, to HALT/Grant Snoop state: immediate Through STPCLK#, to Normal state: 8 bus clocks	0.5 W	Yes	H/W controlled entry/exit mobile throttling
HALT/Grant Snoop	A few bus clocks after the end of snoop activity.	Not specified	Yes	Supports snooping in the low power states
Sleep	To Stop Grant state 10 bus clocks	0.5 W	No	H/W controlled entry/exit desktop idle mode support
Deep Sleep	30 μsec	150 mW	No	H/W controlled entry/exit powered-on suspend support

NOTE: Not 100% tested. Specified at 50°C by design/characterization.

2.2.6 HALT/GRANT SNOOP State

The processor will respond to snoop transactions on the system bus while in the Auto Halt, Stop Grant or Quick Start state. When a snoop transaction is presented on the system bus the processor will enter the HALT/Grant Snoop state. The processor will remain in this state until the snoop has been serviced and the system bus is quiet. After the

snoop has been serviced, the processor will return to its previous state. If the HALT/Grant Snoop state is entered from the Quick Start state, then the input signal restrictions of the Quick Start state still apply in the HALT/Grant Snoop state, except for those signal transitions that are required to perform the snoop.



2.2.7 SLEEP State

The Sleep state is a very low power state in which the processor maintains its context and the phase-locked loop (PLL) maintains phase lock. The Sleep state can only be entered from the Stop Grant state. After entering the Stop Grant state, the SLP# signal can be asserted, causing the processor to enter the Sleep state. The SLP# signal is not recognized in the Normal or Auto Halt states.

The processor can be reset by the RESET# signal while in the Sleep state. If RESET# is driven active while the processor is in the Sleep state then SLP# and STPCLK# must immediately be driven inactive to ensure that the processor correctly initializes itself.

Input signals (other than RESET#) may not change while the processor is in the Sleep state or transitioning into or out of the Sleep state. Input signal changes at these times will cause unpredictable behavior. Thus, the processor is incapable of snooping or latching any events in the Sleep state.

While in the Sleep state, the processor can enter its lowest power state, the Deep Sleep state. Removing the processor's input clock puts the processor in the Deep Sleep state. PICCLK may be removed in the Sleep state.

2.2.8 Deep Sleep State

The Deep Sleep state is the lowest power mode the processor can enter while maintaining its context. The Deep Sleep state is entered by stopping the BCLK input to the processor, while it is in the Sleep or Quick Start state. For proper operation, the BCLK input should be stopped in the low state.

The processor will return to the Sleep or Quick Start state from the Deep Sleep state when the BCLK input is restarted. Due to the PLL lock latency, there is a 30 μ sec delay after the clocks have started before this state transition happens. PICCLK may be removed in the Deep Sleep state. PICCLK should be designed to turn on when BCLK turns on when transitioning out of the Deep Sleep state.

The input signal restrictions for the Deep Sleep state are the same as for the Sleep state, except that RESET# assertion will result in unpredictable behavior.

2.2.9 Operating System Implications of Quick Start and Sleep States

There are a number of architectural features of the Mobile Pentium® II processor that are not available when the Quick Start state is enabled or do not function in the Quick Start or Sleep state as they do in the Stop Grant state. These features are part of the time-stamp counter and performance monitor counters. The time-stamp counter and the performance monitor counters are not guaranteed to count in the Quick Start or Sleep states.

2.3 Low Power GTL+

The Mobile Pentium® II processor system bus signals use a variation of the low voltage swing GTL signaling technology. The Mobile Pentium II processor system bus specification is similar to the Pentium II processor system bus specification, which is a version of GTL with enhanced noise margins and less ringing. The Mobile Pentium II processor system bus specification reduces system cost and power consumption by raising the termination voltage and termination resistance and changing the termination from dual ended to single ended. Because the specification is different from the standard GTL specification and from the Pentium II processor GTL+ specification, it is referred to as Low Power GTL+.

The Pentium II processor GTL+ system bus depends on incident wave switching and uses flight time for timing calculations of the GTL+ signals. The Low Power GTL+ system bus is short and lightly loaded. With Low Power GTL+ signals, timing calculations are based on capacitive derating. Analog signal simulation of the system bus including trace lengths is highly recommended to ensure that there are no significant transmission line effects. Contact your field sales representative to receive the IBIS models for the Mobile Pentium II processor.



**MOBILE PENTIUM® II PROCESSOR IN MICRO-PGA AND BGA PACKAGES
AT 400 MHZ, 366 MHZ, 333 MHZ, 300PE MHZ, AND 266PE MHZ**

The GTL+ system bus of the Pentium II processor was designed to support high-speed data transfers with multiple loads on a long bus that behaves like a transmission line. However, in a mobile system, the system bus only has two loads (the processor and the chipset) and the bus traces are short enough that transmission line effects are not significant. It is possible to change the layout and termination of the system bus to take advantage of the mobile environment using the same GTL+ I/O buffers. The benefit is that it reduces the number of terminating resistors in half and substantially reduces the AC and DC power dissipation of the system bus. Low Power GTL+ uses GTL+ I/O buffers but only two loads are allowed. The trace length is limited and the bus is terminated at one end only. Since the system bus is small and lightly loaded, it behaves like a capacitor, and the GTL+ I/O buffers behave like high-speed open-drain buffers. With a 66-MHz bus frequency, the pull-up would be 120Ω. If 100Ω termination resistors are used rather than 120Ω, then 20% more power will be dissipated in the termination resistors. 120Ω termination is recommended to conserve power.

Refer to the *Mobile Pentium® II Processor System Bus Layout Guideline* (Order Number 243672-001) for details on laying out the Low Power GTL+ system bus.

2.3.1 GTL+ Signals

Two signals of the system bus can potentially not meet the Low Power GTL+ layout requirements:

PRDY# and RESET#. These two signals connect to the debug port and might not meet the maximum length requirements. If PRDY# or RESET# do not meet the layout requirements for Low Power GTL+, then they must be terminated using dual-ended termination at 120Ω. Higher resistor values can be used if simulations show that the signal quality specifications in Section 4 are met.

2.4 Mobile Pentium® II Processor CPUID

The Mobile Pentium® II processor has the same CPUID family and model number as some Celeron™ processors. The Mobile Pentium II processor can be distinguished from these Celeron processors by looking at the stepping number and the CPUID cache descriptor information. A Mobile Pentium II processor has a stepping number in the range of 0AH to 0FH (0AH to 0CH for the 400 MHz, 0DH to 0FH for the 366 MHz and below) and an L2 cache descriptor of 042H (256-Kbyte L2 cache). If the stepping number is less than 0AH or the L2 cache descriptor is not 042H then the processor is a Celeron processor. The L2 cache must be properly initialized for the L2 cache descriptor information to be correct. After a power-on RESET, or when the CPUID instruction is executed, the EAX register contains the values shown in Table 2.3. After the L2 cache is initialized, the CPUID cache/TLB descriptors will be the values shown in Table 2.4.

Table 2.3 Mobile Pentium® II Processor CPUID

Reserved [31:14]	Type [13:12]	Family [11:8]	Model [7:4]	Stepping [3:0]
X	0	6	6	0DH– 0FH (400 MHz)
				0AH – 0CH (366 MHz and below)

Table 2.4 Mobile Pentium® II Processor CPUID Cache and TLB Descriptors

Cache and TLB Descriptors	01H, 02H, 03H, 04H, 08H, 0CH, 42H
----------------------------------	-----------------------------------

**MOBILE PENTIUM® II PROCESSOR IN MICRO-PGA AND BGA PACKAGES
AT 400 MHZ, 366 MHZ, 333 MHZ, 300PE MHZ, AND 266PE MHZ**





3. ELECTRICAL SPECIFICATIONS

All Low Power GTL+ signals are synchronous with the BCLK signal. All TAP signals are synchronous with the TCK signal except TRST#. All CMOS input signals can be applied asynchronously.

3.1 Processor System Signals

Table 3.1 lists the processor system signals by type.

Table 3.1 System Signal Groups

Group Name	Signals
Low Power GTL+ Input	BPRI#, DEFER#, RESET#, RS[2:0]#, RSP#, TRDY#
Low Power GTL+ Output	PRDY#
Low Power GTL+ I/O	A[35:3]#, ADS#, AERR# ⁵ , AP[1:0]#, BERR#, BINIT#, BNR#, BP[3:2]#, BPM[1:0]#, BREQ0#, D[63:0]#, DBSY#, DEP[7:0]#, DRDY#, HIT#, HITM#, LOCK#, REQ[4:0]#, RP#
CMOS Input ^{1,2}	A20M#, BSEL, FLUSH#, IGNNE#, INIT#, INTR, NMI, PREQ#, PWRGOOD, SLP#, SMI#, STPCLK#
Open Drain Output ²	FERR#, IERR#, VTOL
Clock ³	BCLK
APIC Clock ²	PICCLK
APIC I/O ²	PICD[1:0]
Thermal Diode	THERMDA, THERMDC
TAP Input ²	TCK, TDI, TMS, TRST#
TAP Output ²	TDO
Power/Other ⁴	EDGECTRLN, NC, PLL1, PLL2, TESTHI, TESTHI2, TESTHI3, TESTLO, V _{CC} , V _{CCP} ¹ , V _{REF} ¹ , V _{SS}

NOTES:

1. See Section 8 for information on the PWRGOOD signal.
2. Except for the 1.6V tolerant VTOL, these signals are tolerant to 1.5V for the 400 MHz, and 2.5V tolerant for the 366 MHz and below. See Table 3.2 for the recommended pull-up resistor.
3. BCLK is a 2.5V tolerant signal.



4. V_{CC} is the power supply for the core logic.
 PLL1 and PLL2 are the power supply for the PLL analog section.
 V_{CCP} is the power supply for the CMOS voltage references.
 V_{REF} is the voltage reference for the Low Power GTL+ input buffers.
 V_{SS} is system ground.
5. The AERR# processor bus pin is removed as a processor feature for the 400 MHz. The pin must still be terminated to V_{CC} through a 120Ω pull-up resistor. But the processor must not be configured to drive or observe the pin.

The CMOS and TAP inputs can be driven from ground to V_{CMOS} . The TAP outputs are open drain and should be pulled up to V_{CMOS} using resistors with the values shown in Table 3.2. If

open drain drivers are used for input signals, then they should also be pulled up to V_{CMOS} using resistors with the values shown in Table 3.2.

Table 3.2 Recommended Resistors for Open Drain Signals

Recommended Resistor Value (Ω)	Open Drain Signal ¹
150 pull-up	TDI, TDO, TESTHI3 ²
680 pull-up	STPCLK#
1K pull-up	INIT#, TCK, TESTHI, TESTHI2, TESTHI3 ² , TMS
680 - 1K pull-down	TRST#
1.5K pull-up (400 MHz)	A20M#, FERR#, FLUSH#, IERR#, IGNNE#, INTR, NMI, PREQ#,
4.7K pull-up (366 MHz and Below)	PWRGOOD, SLP#, SMI#, VTOL

NOTE:

1. Refer to Section 3.1.4 for the required pull-up or pull-down resistors for signals that are not being used.
2. The TESTHI3 signal must be pulled up to V_{CC} using a 150Ω resistor on 400 MHz processors. On 366 MHz and below the resistor may be between 150Ω and $1K\Omega$.

3.1.1 Power Sequencing Requirements

The Mobile Pentium® II processor has no power sequencing requirements. It is recommended that all of the processor power planes rise to their specified values within one second of each other.

The V_{CC} power plane must not rise too fast. At least $200\ \mu\text{sec}$ (T_R) must pass from the time that V_{CC} is at 10% of its nominal value until the time that V_{CC} is at 90% of its nominal value (See Figure 3.1).

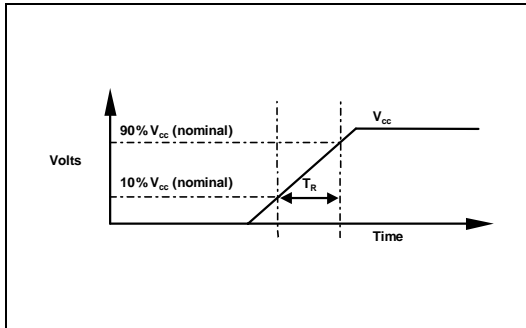

Figure 3.1 Ramp Rate Requirement

3.1.2 Test Access Port (TAP) Connection

The TAP interface is an implementation of the IEEE 1149.1 ("JTAG") standard. Due to the voltage levels supported by the TAP interface, it is recommended that the Mobile Pentium II processor and the other 1.5V/2.5V JTAG specification compliant devices be last in the JTAG chain after any devices with 3.3V or 5V JTAG interfaces within the system. A translation buffer should be used to reduce the TDO output voltage of the last 3.3/5V device down to the V_{CMOS} range that the Mobile Pentium II processor can tolerate. Multiple copies of TCK, TMS, and TRST# must be provided, one for each voltage level.

A Debug Port and connector may be placed at the start and end of the JTAG chain containing the processor, with TDI to the first component coming from the Debug Port and TDO from the last component going to the Debug Port. There are no requirements for placement of the Mobile Pentium II processor in the JTAG chain, except for those that are dictated by voltage requirements of the TAP signals.

3.1.3 Catastrophic Thermal Protection

The Mobile Pentium II processor does not support catastrophic thermal protection or the THERMTRIP# signal. An external thermal sensor should use the

thermal diode to protect the processor and the system against excessive temperatures.

3.1.4 Unused Signals

All signals named NC must be unconnected. All signals named TESTLO must be pulled down to V_{SS} , or tied directly to V_{SS} . All signals named TESTHI or TESTHI3 must be pulled up to V_{CC} with a resistor. All signals named TESTHI2 must be pulled up to V_{CCP} with a resistor. Each TESTHI and TESTHI2 signal must have an individual, $1k\Omega$ pull-up resistor. The TESTHI3 signals can share a single pull-up of 150Ω for the 400 MHz processor and 150Ω to $1K\Omega$ for 366 MHz and below.

Unused Low Power GTL+ inputs, outputs and bi-directional signals should be individually connected to V_{CC} with 120Ω pull-up resistors. Unused CMOS active low inputs should be connected to V_{CMOS} . Unused active high inputs should be connected to V_{SS} . Unused open-drain outputs should be unconnected. If the processor is configured to enter the Quick Start state rather than the Stop Grant state, then the SLP# signal should be connected to V_{CMOS} . When tying any signal to power or ground, a resistor will allow for system testability. For unused signals, it is suggested that $1k\Omega$ resistors be used for pull-ups and for pull-downs.

PICCLK and PICD[1:0] must be tied to V_{SS} with a $1k\Omega$ resistor. BSEL must be connected to V_{SS} .

3.1.5 Signal State in Low Power States

3.1.5.1 System Bus Signals

All of the system bus signals have Low Power GTL+ input, output or input/output drivers. Except when servicing snoops, the system bus signals are tri-stated and pulled up by the termination resistors. Snoops are not permitted in the Sleep and Deep Sleep states.

3.1.5.2 CMOS and Open-Drain Signals

The CMOS input signals are allowed to be in either the logic high or low state when the processor is in a



low power state. In the Auto Halt and Stop Grant states these signals are allowed to toggle. These input buffers have no internal pull-up or pull-down resistors and system logic can use CMOS or open-drain drivers to drive them.

The open-drain output signals have open drain drivers and external pull-up resistors are required. One of the two output signals (IERR#) is a catastrophic error indicator and is tri-stated (and pulled-up) when the processor is functioning normally. The FERR# output can be either tri-stated or driven to V_{SS} when the processor is in a low power state, depending on the condition of the floating point unit. Since this signal is a DC current path when it is driven to V_{SS} , it is recommended that the software clears or masks any floating point error condition before putting the processor into the Deep Sleep state.

3.1.5.3 Other Signals

The system bus clock (BCLK) must be driven in all of the low power states except the Deep Sleep state.

3.2 Power Supply Requirements

3.2.1 Decoupling Recommendations

The amount of bulk decoupling required to meet the processor voltage tolerance requirements is a

strong function of the power supply design. Contact your Intel Field Sales Representative for tools to help determine how much decoupling is required. The processor core power plane (V_{CC}) should have at least twenty-six $0.1\mu\text{F}$ high frequency decoupling capacitors. The CMOS voltage reference power plane (V_{CCP}) requires 50 to $100\mu\text{F}$ of bulk decoupling and at least eight $0.1\mu\text{F}$ high frequency decoupling capacitors.

For the Low Power GTL+ pull-up resistors, one $0.1\mu\text{F}$ high frequency decoupling capacitor is recommended per resistor pack. There should be no more than eight pull-up resistors per resistor pack. The Low Power GTL+ voltage reference power plane (V_{REF}) should have at least three $0.1\mu\text{F}$ high frequency decoupling capacitors.

3.2.2 Voltage Planes

All V_{CC} and V_{SS} balls/pins must be connected to the appropriate voltage plane. All V_{CCP} and V_{REF} balls/pins must be connected to the appropriate traces on the system electronics.

In addition to the main V_{CC} , V_{CCP} and V_{SS} power supply signals, PLL1 and PLL2 provide isolated power to the PLL section. PLL1 and PLL2 should be connected according to Figure 3.2. Do not connect PLL2 directly to V_{SS} . A separate power supply should be used to generate V_{CCP} to isolate the PLL from processor core noise. Table 3.3 contains the requirements for C1 and L1.

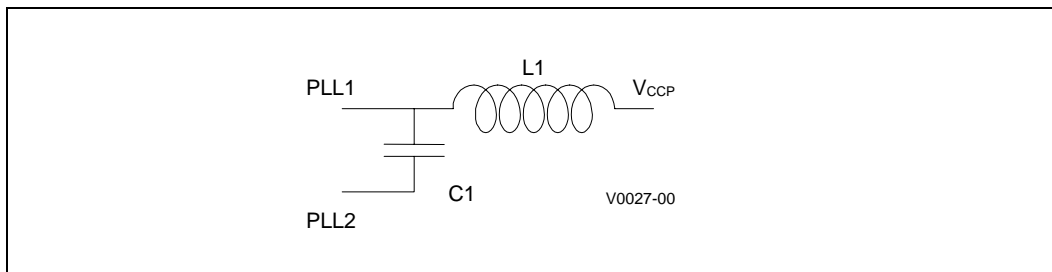

Figure 3.2 PLL LC Filter



Table 3.3 LC Filter Specifications

Symbol	Parameter	Min	Max	Unit	Notes
C1	LC Filter Capacitance	47		μF	≤30% tolerance, 1Ω max series resistance, ~2nH series inductance
L1	LC Filter Inductance	20	47	μH	low-Q type choke, ≤30% tolerance, 1.5Ω max series resistance, ≥50mA current, self-resonant frequency >10 MHz

3.3 System Bus Clock and Processor Clocking

The 2.5V BCLK clock input directly controls the operating speed of the system bus interface. All system bus timing parameters are specified with respect to the rising edge of the BCLK input. The Mobile Pentium II processor core frequency is a multiple of the BCLK frequency.

The Mobile Pentium® II processor (0.18μm) at 400 MHz is implemented with the Bus Fraction Locking scheme, which allows the processor to operate at the marked core frequency only. The bus ratio configuration signals are not effective. However, if desired, the signals can be set accordingly to Table 3.4.

Table 3.4 Core Frequency to System Bus Ratio Configuration

Processor Core Frequency to System Bus Frequency Ratio	NMI	INTR	IGNNE#	A20M#	Powerup Configuration [25:22]
4/1 (266 MHz)	L	L	L	H	0010
9/2 (300 MHz)	L	H	L	H	0110
5/1 (333 MHz)	L	L	H	H	0000
11/2 (366 MHz)	L	H	H	H	0100
6/1 (400 MHz)	H	L	L	L	1011

The mobile Pentium II processors at 366 MHz and below frequencies are implemented with a *Bus fraction Limiting scheme*. A multiplexer is required between the system electronics and the processor to drive the bus ratio configuration signals during Reset. Figure 3.6 and Table 3.18 describe the

timing requirements for this operation. The 443BX CRESET# signal has suitable timing to control the multiplexer. After RESET# and PWRGOOD are asserted, the multiplexer logic must guarantee that the bus ratio configuration signals encode one of the bus ratios in Table 3.4 and that the bus ratio



corresponds to a core frequency at or below the marked core frequency for the processor. The selected bus ratio is visible to software in the Power-On configuration register, see Section 7.2 for details.

Multiplying the bus clock frequency is necessary to increase performance while allowing for easier distribution of signals within the system. Clock multiplication within the processor is provided by the internal Phase Lock Loop (PLL), which requires a constant frequency BCLK input. During Reset, or on exit from the Deep Sleep state, the PLL requires some amount of time to acquire the phase of BCLK. This time is called the PLL lock latency, which is specified in Section 3.6, AC timing parameters T18 and T47. Except for the 400 MHz processor, the system bus frequency ratio can be changed when RESET# is active, assuming that all Reset specification are met. The BCLK frequency should

not be changed during Deep Sleep state (see Section 2.2.8).

3.4 Maximum Ratings

Table 3.5 and Table 3.6 contains the Mobile Pentium II processor stress ratings. Functional operation at the absolute maximum and minimum is neither implied nor guaranteed. The processor should not receive a clock while subjected to these conditions. Functional operating conditions are provided in the AC and DC tables. Extended exposure to the maximum ratings may affect device reliability. Furthermore, although the processor contains protective circuitry to resist damage from static electric discharge, one should always take precautions to avoid high static voltages or electric fields.

Table 3.5 Absolute Maximum Ratings for Mobile Pentium® II Processor at 400 MHz

Symbol	Parameter	Min	Max	Unit	Notes
T _{Storage}	Storage Temperature	-40	85	°C	Note1
V _{CC(Abs)}	Supply Voltage with respect to V _{SS}	-0.5	2.0	V	
V _{CCP}	CMOS Reference Voltage with respect to V _{SS}	-0.3	2.0	V	
V _{IN}	GTL+ Buffer DC Input Voltage with respect to V _{SS}	-0.3	V _{CC} + 0.5	V	Note 2
V _{IN15}	1.5V Buffer DC Input Voltage with respect to V _{SS}	-0.3	2.0	V	Note 3
V _{BLCK}	BLCK Buffer DC Input Voltage with respect to V _{SS}	-0.3	3.3	V	

NOTES:

1. The shipping container is only rated for 65°C.
2. Parameter applies to the Low Power GTL+ signal groups only.
3. Parameter applies to CMOS, Open-Drain, APIC and TAP bus signal groups only.



MOBILE PENTIUM® II PROCESSOR IN MICRO-PGA AND BGA PACKAGES
AT 400 MHZ, 366 MHZ, 333 MHZ, 300PE MHZ, AND 266PE MHZ

Table 3.6 Absolute Maximum Ratings for Mobile Pentium® II Processor at 366 MHz and Below

Symbol	Parameter	Min	Max	Unit	Notes
T _{Storage}	Storage Temperature	-40	85	°C	Note1
V _{CC(Abs)}	Supply Voltage with respect to V _{SS}	-0.5	3.0	V	
V _{CCP}	CMOS Reference Voltage with respect to V _{SS}	-0.3	3.0	V	
V _{IN}	GTL+ Buffer DC Input Voltage with respect to V _{SS}	-0.3	V _{CC} + 0.7	V	Note 2
V _{BLCK}	2.5V Buffer DC Input Voltage with respect to V _{SS}	-0.3	3.3	V	Note 3

NOTES:

1. The shipping container is only rated for 65°C.
2. Parameter applies to the Low Power GTL+ signal groups only.
3. Parameter applies to CMOS, Open-Drain, APIC and TAP bus signal groups only.



3.5 DC Specifications

Table 3.7 through Table 3.12 list the DC specifications for the Mobile Pentium II processor . Specifications are valid only while meeting

specifications for case temperature, clock frequency and input voltages. Care should be taken to read all notes associated with each parameter.

Table 3.7 Power Specifications for Mobile Pentium® II Processor at 400 MHz

T _{CASE} = 0 to T _{CASE,max} ; V _{CC} = 1.5V ±115mV; V _{CCP} = 1.5V ±90mV						
Symbol	Parameter	Min	Typ	Max	Unit	Notes
V _{CC}	V _{CC} for core logic	1.385	1.500	1.615	V	±115 mV
V _{CCP}	V _{CC} for CMOS voltage references	1.410	1.500	1.590	V	±90 mV
I _{CC}	I _{CC} for V _{CC} at core @ 400 MHz frequency			7.10	A	Note 3
I _{CCP}	Current for V _{CCP}			100	mA	Notes 1, 2, 3
I _{CC,SG}	Processor Stop Grant and Auto Halt current			1.29	A	Note 3
I _{CC,QS}	Processor Quick Start and Sleep current			994	mA	Note 3
I _{CC,DSL}	Processor Deep Sleep leakage current			700	mA	Note 3
dI _{CC} /dt	V _{CC} power supply current slew rate			20	A/μs	Notes 4, 5

NOTES:

1. I_{CCP} is the current supply for the CMOS voltage references.
2. Not 100% tested. Specified by design/characterization.
3. I_{CC,max} specifications are specified at V_{CC,max}, V_{CCP,max} and 100°C and under maximum signal loading conditions.
4. Based on simulations and averaged over the duration of any change in current. Use to compute the maximum inductance and reaction time of the voltage regulator. This parameter is not tested.
5. Maximum values specified by design/characterization at nominal V_{CC} and V_{CCP}.



**MOBILE PENTIUM® II PROCESSOR IN MICRO-PGA AND BGA PACKAGES
AT 400 MHZ, 366 MHZ, 333 MHZ, 300PE MHZ, AND 266PE MHZ**

Table 3.8 Power Specifications for Mobile Pentium® II Processor at 366 MHz and Below

T _{CASE} = 0 to T _{CASE,max} ; V _{CC} = 1.6V ±135mV; V _{CCP} = 1.8V ±90mV						
Symbol	Parameter	Min	Typ	Max	Unit	Notes
V _{CC}	V _{CC} of core logic for regular voltage processors	1.465	1.600	1.735	V	±135 mV
V _{CC,LP}	V _{CC} when I _{CC} < 300 mA	1.465	1.600	1.805	V	+205/-135 mV ¹
V _{CCP}	V _{CC} for CMOS voltage references	1.710	1.800	1.890	V	1.8V ±90 mV
I _{CC}	I _{CC} for V _{CC} at core frequency @ 366 MHz @ 333 MHz @ 300PE MHz @ 266PE MHz			8.87 7.95 7.49 6.63	A A A A	Note 4
I _{CCP}	Current for V _{CCP}			75	mA	Notes 2, 3, 4
I _{CC,SG}	Processor Stop Grant and Auto Halt current			1190	mA	Note 4
I _{CC,QS}	Processor Quick Start and Sleep current			880	mA	Note 4
I _{CC,DSL}	Processor Deep Sleep leakage current			650	mA	Note 4
di _{CC} /dt	V _{CC} power supply current slew rate			20	A/μs	Notes 5, 6

NOTES:

1. A higher V_{CC,MAX} is allowed when the processor is in a low power state to enable high efficiency, low current modes in the power regulator.
2. I_{CCP} is the current supply for the CMOS voltage references.
3. Not 100% tested. Specified by design/characterization.
4. I_{CC,max} specifications are specified at V_{CC,max}, V_{CCP,max} and 100°C and under maximum signal loading conditions.
5. Based on simulations and averaged over the duration of any change in current. Use to compute the maximum inductance and reaction time of the voltage regulator. This parameter is not tested.
6. Maximum values specified by design/characterization at nominal V_{CC} and V_{CCP}.



Table 3.9 Power Specifications for Low Voltage Pentium® II Processor

T _{CASE} = 0 to T _{CASE,max} ; V _{CC} = 1.5V ±135mV; V _{CCP} = 1.8V ±90mV						
Symbol	Parameter	Min	Typ	Max	Unit	Notes
V _{CC}	V _{CC} of core logic for 266PE MHz at low voltage	1.365	1.500	1.635	V	±135 mV
V _{CC,LP}	V _{CC} when I _{CC} < 300 A	1.365	1.500	1.705	V	+205/-135 mV ¹
V _{CCP}	V _{CC} for CMOS voltage references	1.710	1.800	1.890	V	1.8V ±90 mV
I _{CC}	I _{CC} for V _{CC} at core frequency @ 266PE MHz at low voltage			5.90	A	Note 4
I _{CCP}	Current for V _{CCP}			75	mA	Notes 2, 3, 4
I _{CC,SG}	Processor Stop Grant and Auto Halt current			940	mA	Note 4
I _{CC,QS}	Processor Quick Start and Sleep current			630	mA	Note 4
I _{CC,DSL}	Processor Deep Sleep leakage current			400	mA	Note 4
dl _{CC} /dt	V _{CC} power supply current slew rate			20	A/μs	Notes 5, 6

NOTES:

1. A higher V_{CC,MAX} is allowed when the processor is in a low power state to enable high efficiency, low current modes in the power regulator.
2. I_{CCP} is the current supply for the CMOS voltage references.
3. Not 100% tested. Specified by design/characterization.
4. I_{CCx,max} specifications are specified at V_{CC,max}, V_{CCP,max} and 100°C and under maximum signal loading conditions.
5. Based on simulations and averaged over the duration of any change in current. Use to compute the maximum inductance and reaction time of the voltage regulator. This parameter is not tested.
6. Maximum values specified by design/characterization at nominal V_{CC} and V_{CCP}.

The signals on the Mobile Pentium II processor system bus are included in the Low Power GTL+ signal group. These signals are specified to be terminated to V_{CC}. The DC specifications for these signals are listed in Table 3.10; the termination and reference voltage specifications for these

signals are listed in Table 3.11. The Mobile Pentium II processor requires external termination and a V_{REF}. Refer to *Mobile Pentium® II Processor System Bus Layout Guideline* (Order Number 243672-001) for full details of system V_{TT} and V_{REF} requirements.



**MOBILE PENTIUM® II PROCESSOR IN MICRO-PGA AND BGA PACKAGES
AT 400 MHZ, 366 MHZ, 333 MHZ, 300PE MHZ, AND 266PE MHZ**

Table 3.10 Low Power GTL+ Signal Group DC Specifications

$T_{CASE} = 0$ to $T_{CASE,max}$; $V_{CC} = 1.5V \pm 115mV$, $V_{CC} = 1.6V \pm 135mV$, or $1.5V \pm 135mV$; $V_{CCP} = 1.5V \pm 90mV$, or $V_{CCP} = 1.8V \pm 90mV$

Symbol	Parameter	Min	Max	Unit	Notes
V_{IL}	Input Low Voltage	-0.3	$\frac{5}{9}V_{TT} - 0.2$	V	See Table 3.11 ¹
V_{IH}	Input High Voltage	$\frac{5}{9}V_{TT} + 0.2$	V_{CC}	V	Note 1
V_{OH}	Output High Voltage	—	—	V	See V_{TT} max in Table 3.11.
R_{ON}	Output Low Drive Strength		35	ohms	
I_L	Leakage Current for inputs		± 100	μA	Note 2
I_{LO}	Leakage Current for outputs & I/Os		± 30	μA	366 MHz and below ³
I_{LO}	Leakage Current for outputs and I/Os		± 100	μA	400 MHz ³

NOTES:

1. V_{REF} worst case, not nominal. Noise on V_{REF} should be accounted for.
2. ($0 \leq V_{IN} \leq V_{CC}$).
3. ($0 \leq V_{out} \leq V_{CC}$).

Table 3.11. Low Power GTL+ Bus DC Specifications

$T_{CASE} = 0$ to $T_{CASE,max}$; $V_{CC} = 1.5V \pm 115mV$, $V_{CC} = 1.6V \pm 135mV$, or $1.5V \pm 135mV$; $V_{CCP} = 1.5V \pm 90mV$, or $V_{CCP} = 1.8V \pm 90mV$

Symbol	Parameter	Min	Typ	Max	Unit	Notes
V_{TT}	Bus Termination Voltage	$V_{CC,MIN}$	V_{CC}	$V_{CC,MAX}$	V	Note 1
V_{REF}	Input Reference Voltage	$\frac{5}{9}V_{TT} - 2\%$	$\frac{5}{9}V_{TT}$	$\frac{5}{9}V_{TT} + 2\%$	V	$\pm 2\%$ ²

NOTES:

1. The intent is to use the same power supply for V_{CC} and V_{TT} .
2. V_{REF} for the system logic should be created from V_{TT} by a voltage divider.

The CMOS, Open-Drain and TAP signals are to other devices. BCLK is a 2.5V clock. The DC designed to interface at V_{CMOS} to allow connection



specifications for these signals are listed in Table 3.12.

Table 3.12 Clock, APIC, TAP, CMOS and Open-Drain Signal Group DC Specifications for the Mobile Pentium® II Processor at 400 MHz

T _{CASE} = 0 to T _{CASE,max} ; V _{CC} = 1.5V ± 115mV, V _{CCP} = 1.5V ± 90mV					
Symbol	Parameter	Min	Max	Unit	Notes
V _{IL}	Input Low Voltage	-0.3	0.6	V	
V _{IL,BCLK}	Input Low Voltage, BCLK	-0.3	0.7	V	
V _{IH}	Input High Voltage	1.135	1.615	V	
V _{IH,BCLK}	Input High Voltage, BCLK	1.8	2.625	V	
V _{OL}	Output Low Voltage		0.4	V	Note 1
V _{OH}	Output High Voltage	N/A	1.615	V	All outputs are open-drain
I _{OL}	Output Low Current		14	mA	
I _L	Leakage Current for inputs, outputs, and I/Os		±100	μA	Note 2

NOTES:

1. Parameter measured at 14 mA.
2. (0 ≤ V_{IN/OUT} ≤ 1.615V).



Table 3.13 Clock, APIC, TAP, CMOS and Open-Drain Signal Group DC Specifications for the Mobile Pentium® II Processor at 366 MHz and Below

T _{CASE} = 0 to T _{CASE,max} ; V _{CC} = 1.6V ± 135mV, or V _{CC} = 1.5V ± 115mV, V _{CCP} = 1.8V ± 90mV					
Symbol	Parameter	Min	Max	Unit	Notes
V _{IL}	Input Low Voltage	-0.3	0.7	V	
V _{IL,BCLK}	Input Low Voltage, BCLK	-0.3	0.7	V	
V _{IH}	Input High Voltage	1.700	2.625	V	
V _{IH,BCLK}	Input High Voltage, BCLK	1.800	2.625	V	
V _{OL}	Output Low Voltage		0.4	V	Note 1
V _{OH}	Output High Voltage	N/A	2.625	V	All outputs are open-drain
I _{OL}	Output Low Current		14	mA	
I _L	Input Leakage Current		±100	µA	Note 2
I _{LO}	Output and I/O Leakage Current		±30	µA	Note 2

NOTES:

1. Parameter measured at 14 mA.
2. (0 ≤ V_{IN/OUT} ≤ 2.625V).

3.6 AC Specifications

3.6.1 System Bus, Clock, APIC, TAP, CMOS and Open-Drain AC Specifications

Table 3.14 through Table 3.21 provide AC specifications associated with the Mobile Pentium II processor. The AC specifications are divided into the following categories: Table 3.14 contains the system bus clock specifications; Table 3.15 contains the processor core frequencies; Table 3.16 contains the Low Power GTL+ specifications; Table

3.17 contains the CMOS and Open-Drain signal groups specifications; Table 3.18 contains timings for the reset conditions; Table 3.19 contains the TAP specifications; and Table 3.20 and Table 3.21 contain the power management timing specifications.

All system bus AC specifications for the Low Power GTL+ signal group are relative to the rising edge of the BCLK input at 1.25V. All Low Power GTL+ timings are referenced to V_{REF} for both '0' and '1' logic levels unless otherwise specified.



Table 3.14 System Bus Clock AC Specifications¹

$T_{CASE} = 0$ to $T_{CASE,max}$; $V_{CC} = 1.5V \pm 115mV$, $V_{CC} = 1.6V \pm 135mV$, or $1.5V \pm 135mV$; $V_{CCP} = 1.5V \pm 90mV$, or $V_{CCP} = 1.8V \pm 90mV$

Symbol	Parameter	Min	Typ	Max	Unit	Figure	Notes
	System Bus Frequency		66.67		MHz		
T1	BCLK Period		15		ns	3.3	Note 2
T2	BCLK Period Stability			±250	ps		Notes 3, 4
T3	BCLK High Time	5.0			ns	3.3	@>1.8V
T4	BCLK Low Time	5.0			ns	3.3	@<0.7V
T5	BCLK Rise Time	0.175		0.875	ns	3.3	(0.9V – 1.6V) ⁴
T6	BCLK Fall Time	0.175		0.875	ns	3.3	(1.6V – 0.9V) ⁴

NOTES:

1. All AC timings for Low Power GTL+ and CMOS signals are referenced to the BCLK rising edge at 1.25V. All CMOS signals are referenced at V_{TRIP} .
2. The BCLK period allows a +0.5ns tolerance for clock driver variation.
3. Not 100% tested. Specified by design/characterization.
4. Measured on the rising edge of adjacent BCLKs at 1.25V. The jitter present must be accounted for as a component of BCLK skew between devices.



**MOBILE PENTIUM® II PROCESSOR IN MICRO-PGA AND BGA PACKAGES
AT 400 MHZ, 366 MHZ, 333 MHZ, 300PE MHZ, AND 266PE MHZ**

Table 3.15 Valid Mobile Pentium® II Processor Frequencies

$T_{CASE} = 0$ to $T_{CASE,max}$; $V_{CC} = 1.5V \pm 115mV$, $V_{CC} = 1.6V \pm 135mV$, or $1.5V \pm 135mV$; $V_{CCP} = 1.5V \pm 90mV$, or $V_{CCP} = 1.8V \pm 90mV$		
BCLK Frequency (MHz)	Frequency Multiplier	Core Frequency (MHz)
66.67	4	266.67
66.67	9/2	300.00
66.67	5	333.33
66.67	11/2	366.67
66.67	6	400.00

NOTE: Because of the Bus Fraction Locking scheme implemented in this processor, the frequency multiplier is internally set to a fixed value of six (6). The processor operates only at a core frequency of 400 MHz.

Table 3.16 Low Power GTL+ Signal Groups AC Specifications¹

$R_{TT} = 120\Omega$ terminated to V_{CC} ; $V_{REF} = 5/9 V_{CC}$; load = 0pF $T_{CASE} = 0$ to $T_{CASE,max}$; $V_{CC} = 1.5V \pm 115mV$, $V_{CC} = 1.6V \pm 135mV$, or $1.5V \pm 135mV$; $V_{CCP} = 1.5V \pm 90mV$, or $V_{CCP} = 1.8V \pm 90mV$						
Symbol	Parameter	Min	Max	Unit	Figure	Notes
T7	Low Power GTL+ Output Valid Delay	0.00	7.78	ns	3.4	
T8	Low Power GTL+ Input Setup Time	2.98		ns	3.5	Notes 2, 3
T9	Low Power GTL+ Input Hold Time	0.90		ns	3.5	Note 4
T10	RESET# Pulse Width	1		ms	3.6 3.7	Note 5

NOTES:

1. All AC timings for Low Power GTL+ signals are referenced to the BCLK rising edge at 1.25V. All Low Power GTL+ signals are referenced at V_{REF} .
2. RESET# can be asserted (active) asynchronously, but must be de-asserted synchronously.
3. Specification is for a minimum 0.40V swing.
4. Specification is for a maximum 1.0V swing.
5. After V_{CC} , V_{CCP} and BCLK become stable and PWRGOOD is asserted.



Table 3.17 CMOS and Open-Drain Signal Groups AC Specifications^{1,2}

T _{CASE} = 0 to T _{CASE,max} ; V _{CC} = 1.5V ± 115mV, V _{CC} = 1.6V ± 135mV, or 1.5V ± 135mV; V _{CCP} = 1.5V ± 90mV, or V _{CCP} = 1.8V ± 90mV						
Symbol	Parameter	Min	Max	Unit	Figure	Notes
T14	CMOS Input Pulse Width, except PWRGOOD	2		BCLKs	3.4	Active and Inactive states
T15	PWRGOOD Inactive Pulse Width	10		BCLKs	3.7	Notes 3, 4

NOTES:

1. All AC timings for CMOS and Open-Drain signals are referenced to the BCLK rising edge at 1.25V. All CMOS and Open-Drain signals are referenced at V_{TRIP}.
2. Minimum output pulse width on CMOS outputs is 2 BCLKs.
3. When driven inactive, or after V_{CC}, V_{CCP} and BCLK become stable. PWRGOOD must remain below V_{IL,max} from Table 3.12 until all the voltage planes meet the voltage tolerance specifications in Table 3.7, and BCLK has met the BCLK AC specifications in Table 3.14 for at least 10 clock cycles. PWRGOOD must rise glitch-free and monotonically to V_{CMOS}.
4. If the BCLK signal meets its AC specification within 150ns of turning on then the PWRGOOD Inactive Pulse Width specification (T15) is waived and BCLK may start after PWRGOOD is asserted. PWRGOOD must still remain below V_{IL,max} until all the voltage planes meet the voltage tolerance specifications.



**MOBILE PENTIUM® II PROCESSOR IN MICRO-PGA AND BGA PACKAGES
AT 400 MHZ, 366 MHZ, 333 MHZ, 300PE MHZ, AND 266PE MHZ**

Table 3.18 Reset Configuration AC Specifications

T _{CASE} = 0 to T _{CASE,max} ; V _{CC} = 1.5V ±115mV; V _{C_{CP}} = 1.5V ±90mV						
Symbol	Parameter	Min	Max	Unit	Figure	Notes
T16	Reset Configuration Signals (A[15:5]#, BREQ0#, FLUSH#, INIT#, PICD0) Setup Time	4		BCLKs	3.5 3.6	Before deassertion of RESET#
T17	Reset Configuration Signals (A[15:5]#, BREQ0#, FLUSH#, INIT#, PICD0) Hold Time	2	20	BCLKs	3.5 3.6	After clock that deasserts RESET#
T18	Reset Configuration Signals (A20M#, IGNNE#, INTR, NMI) Setup Time	1		ms	3.7	Before deassertion of RESET# ¹
T19	Reset Configuration Signals (A20M#, IGNNE#, INTR, NMI) Delay Time		5	BCLKs	3.7	After assertion of RESET# ²
T20	Reset Configuration Signals (A20M#, IGNNE#, INTR, NMI) Hold Time	2	20	BCLKs	3.5 3.7	After clock that deasserts RESET#

NOTES:

1. At least 1 ms must pass after PWRGOOD rises above V_{IH,min} from Table 3.12, and BCLK meets its AC timing specification, until RESET# may be deasserted.
2. For a Reset, the clock ratio defined by these signals must be a safe value (their final value or a lower multiplier) within this delay after RESET# is asserted unless PWRGOOD is inactive (below V_{IL,max}).



Table 3.19 TAP Signal AC Specifications¹

T _{CASE} = 0 to T _{CASE,max} ; V _{CC} = 1.5V ±115mV; V _{CCP} = 1.5V ±90mV						
Symbol	Parameter	Min	Max	Unit	Figure	Notes
T30	TCK Frequency	—	16.67	MHz		
T31	TCK Period	60	—	ns	3.3	
T32	TCK High Time	25.0		ns	3.3	≥ 1.135V ²
T33	TCK Low Time	25.0		ns	3.3	≤ 0.60V ²
T34	TCK Rise Time		5.0	ns	3.3	(0.60V-1.135V) ^{2,3}
T35	TCK Fall Time		5.0	ns	3.3	(1.135V-0.60V) ^{2,3}
T36	TRST# Pulse Width	40.0		ns	3.9	Asynchronous ²
T37	TDI, TMS Setup Time	5.0		ns	3.8	Note 4
T38	TDI, TMS Hold Time	14.0		ns	3.8	Note 4
T39	TDO Valid Delay	1.0	10.0	ns	3.8	Notes 5, 6
T40	TDO Float Delay		25.0	ns	3.8	Notes 2, 5, 6
T41	All Non-Test Outputs Valid Delay	2.0	25.0	ns	3.8	Notes 5, 7, 8
T42	All Non-Test Outputs Float Delay		25.0	ns	3.8	Notes 2, 5, 7, 8
T43	All Non-Test Inputs Setup Time	5.0		ns	3.8	Notes 4, 7, 8
T44	All Non-Test Inputs Hold Time	13.0		ns	3.8	Notes 4, 7, 8

NOTES:

1. All AC timings for TAP signals are referenced to the TCK rising edge at V_{TRIP}. All CMOS signals are referenced at V_{TRIP}.
2. Not 100% tested. Specified by design/characterization.
3. 1 ns can be added to the maximum TCK rise and fall times for every 1 MHz below 16 MHz.
4. Referenced to TCK rising edge.
5. Referenced to TCK falling edge.
6. Valid delay timing for this signal is specified into 150Ω terminated to V_{CMOS} and 0pF of external load. For real system timings these specifications must be derated for external capacitance at 105 ps/pF.
7. Non-Test Outputs and Inputs are the normal output or input signals (except TCK, TRST#, TDI, TDO and TMS). These timings correspond to the response of these signals due to boundary scan operations.
8. During Debug Port operation use the normal specified timings rather than the TAP signal timings.



**MOBILE PENTIUM® II PROCESSOR IN MICRO-PGA AND BGA PACKAGES
AT 400 MHZ, 366 MHZ, 333 MHZ, 300PE MHZ, AND 266PE MHZ**

Table 3.20 Quick Start/Deep Sleep AC Specifications

$T_{CASE} = 0$ to $T_{CASE,max}$; $V_{CC} = 1.5V \pm 115mV$, $V_{CC} = 1.6V \pm 135mV$, or $1.5V \pm 135mV$; $V_{CCP} = 1.5V \pm 90mV$, or $V_{CCP} = 1.8V \pm 90mV$

Symbol	Parameter	Min	Max	Unit	Figure
T45	Stop Grant Cycle Completion to Clock Stop	100		BCLKs	3.10
T46	Stop Grant Cycle Completion to Input Signals Stable		0	ns	3.10
T47	Deep Sleep PLL Lock Latency		30	μ s	3.10
T48	STPCLK# Hold Time from PLL Lock	0		ns	3.10
T49	Input Signal Hold Time from STPCLK# Deassertion	8		BCLKs	3.10

NOTE: Input signals other than RESET# and BPRI# must be held constant in the Quick Start state.

Table 3.21 Stop Grant/Sleep/Deep Sleep AC Specifications

$T_{CASE} = 0$ to $T_{CASE,max}$; $V_{CC} = 1.5V \pm 115mV$, $V_{CC} = 1.6V \pm 135mV$, or $1.5V \pm 135mV$; $V_{CCP} = 1.5V \pm 90mV$, or $V_{CCP} = 1.8V \pm 90mV$

Symbol	Parameter	Min	Max	Unit	Figure
T50	SLP# Signal Hold Time from Stop Grant Cycle Completion	100		BCLKs	3.11
T51	SLP# Assertion to Input Signals Stable		0	ns	3.11
T52	SLP# Assertion to Clock Stop	10		BCLKs	3.11
T54	SLP# Hold Time from PLL Lock	0		ns	3.11
T55	STPCLK# Hold Time from SLP# Deassertion	10		BCLKs	3.11
T56	Input Signal Hold Time from SLP# Deassertion	10		BCLKs	3.11

NOTE: Input signals other than RESET# must be held constant in the Sleep state.



Figure 3.3 through Figure 3.11 are to be used in conjunction with Table 3.14 through Table 3.21.

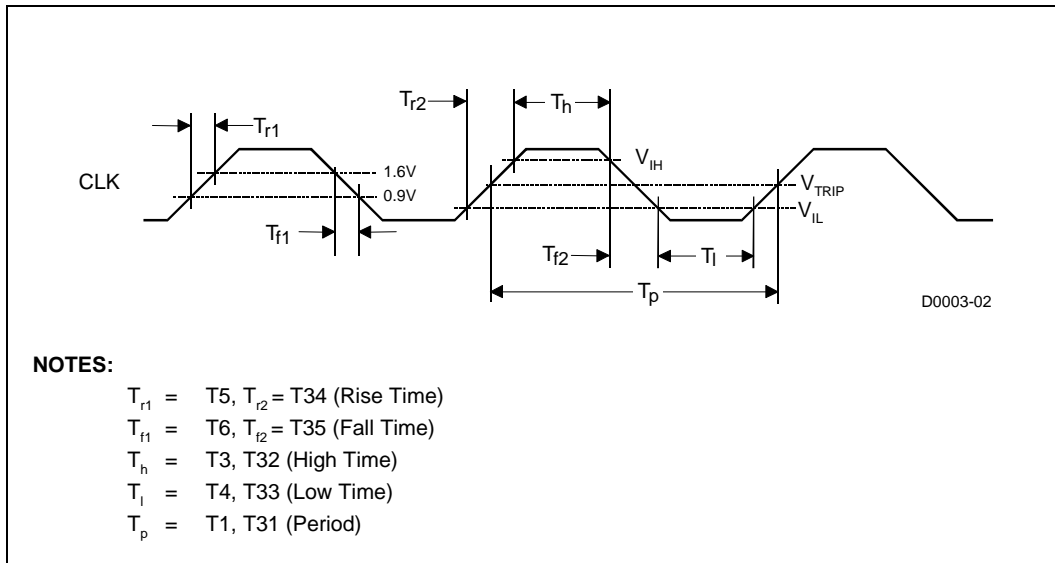

Figure 3.3 Generic Clock Waveform



MOBILE PENTIUM® II PROCESSOR IN MICRO-PGA AND BGA PACKAGES
AT 400 MHZ, 366 MHZ, 333 MHZ, 300PE MHZ, AND 266PE MHZ

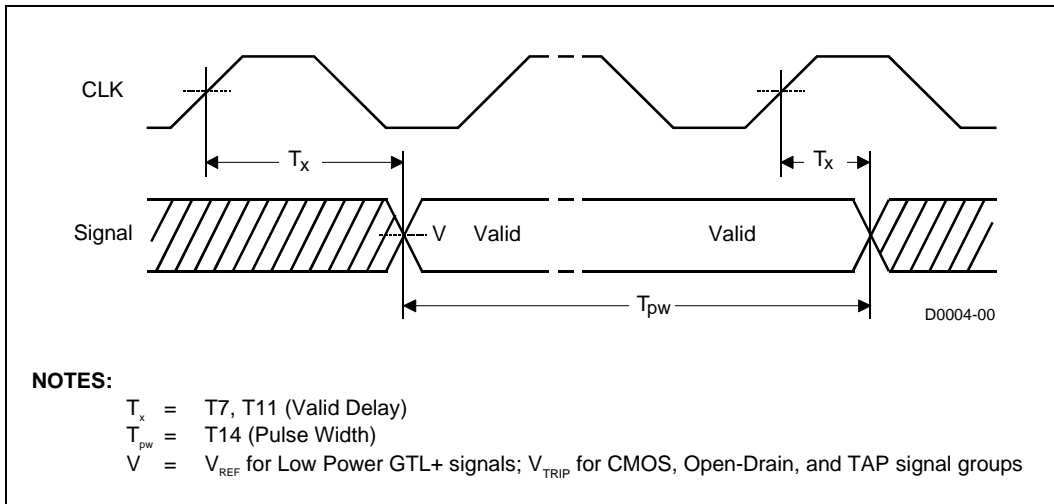

Figure 3.4 Valid Delay Timings

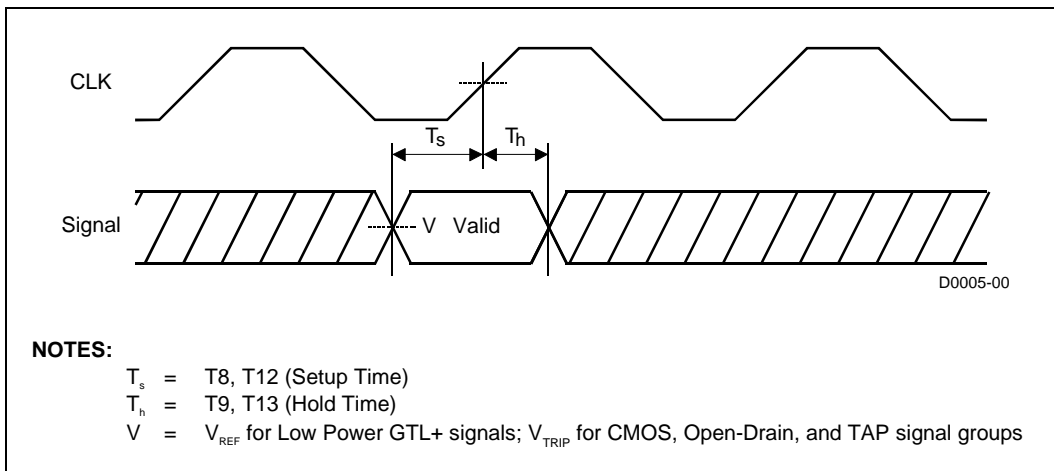

Figure 3.5 Setup and Hold Timings

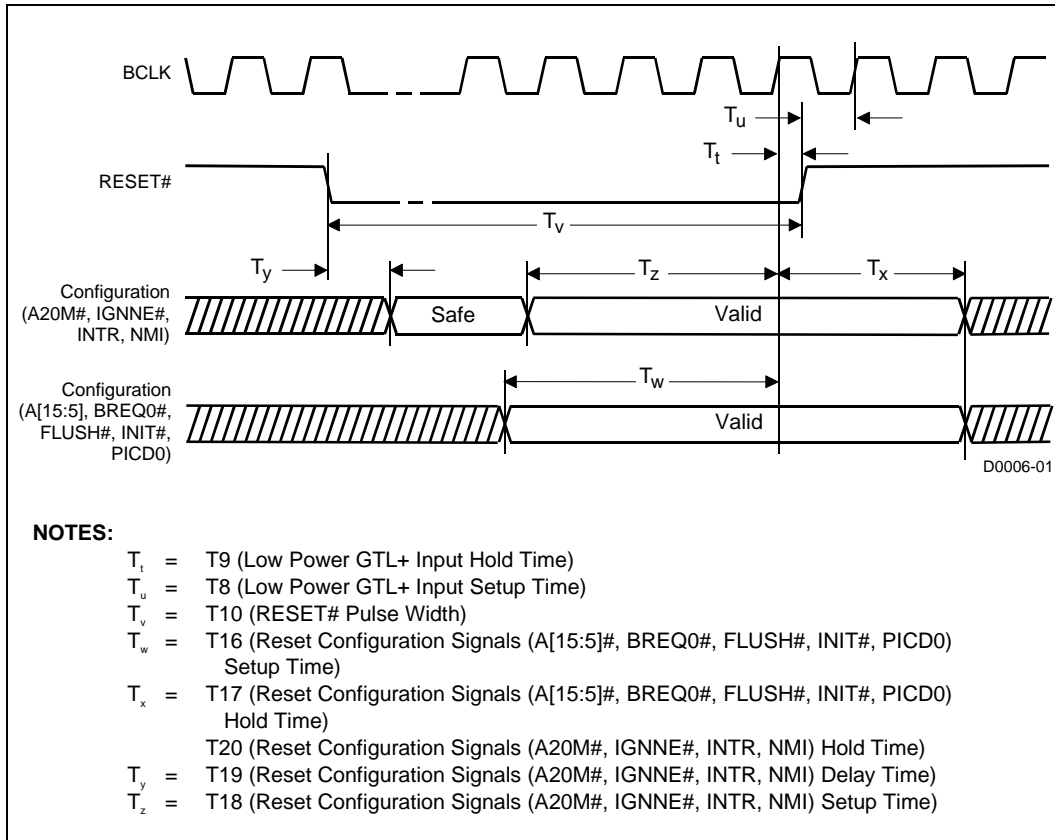

Figure 3.6 Reset and Configuration Timings



MOBILE PENTIUM® II PROCESSOR IN MICRO-PGA AND BGA PACKAGES
AT 400 MHZ, 366 MHZ, 333 MHZ, 300PE MHZ, AND 266PE MHZ

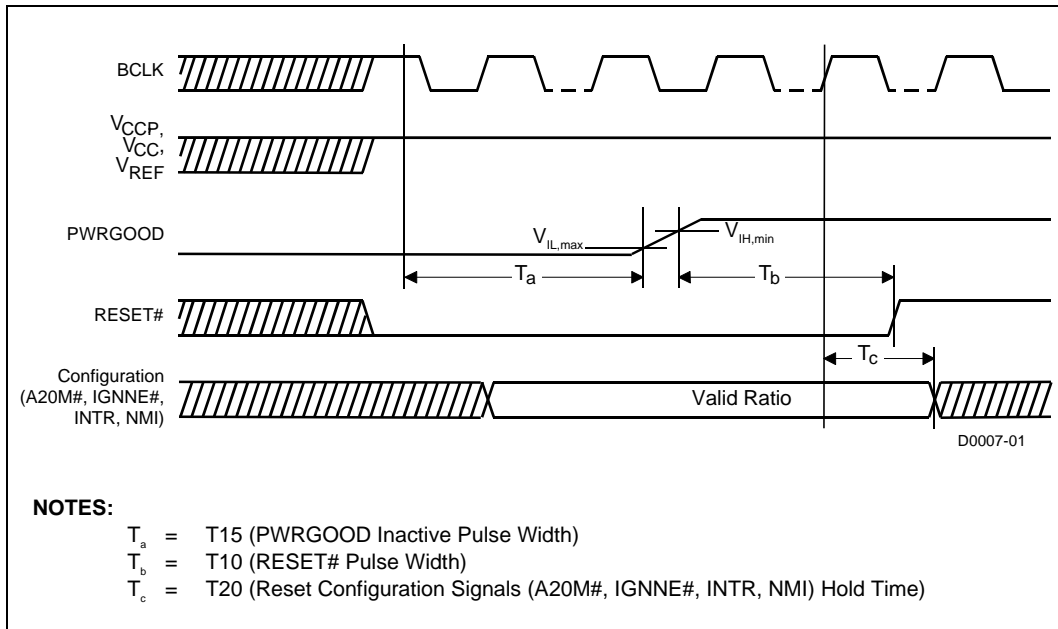

Figure 3.7 Power-On Reset Timings

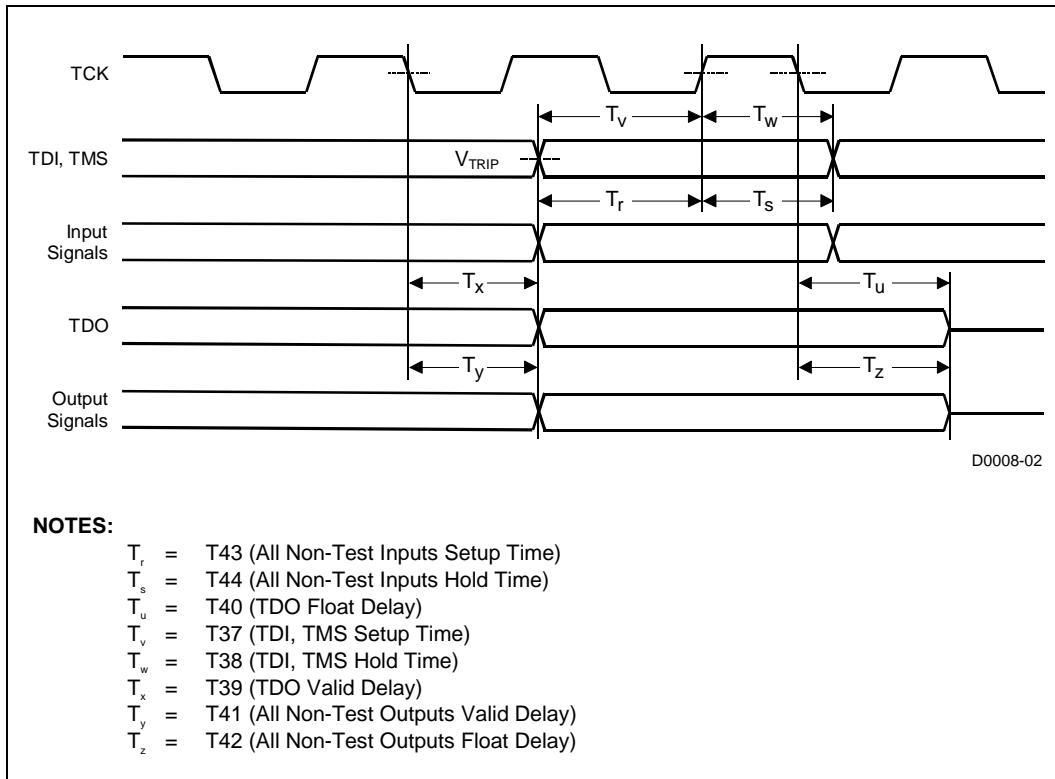

Figure 3.8 Test Timings (Boundary Scan)

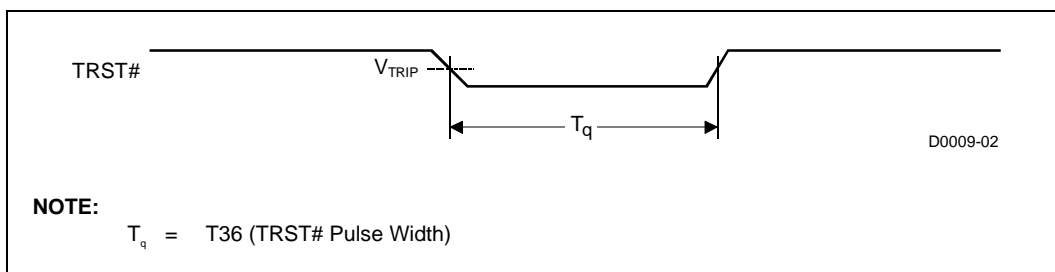

Figure 3.9 Test Reset Timings



**MOBILE PENTIUM® II PROCESSOR IN MICRO-PGA AND BGA PACKAGES
AT 400 MHZ, 366 MHZ, 333 MHZ, 300PE MHZ, AND 266PE MHZ**

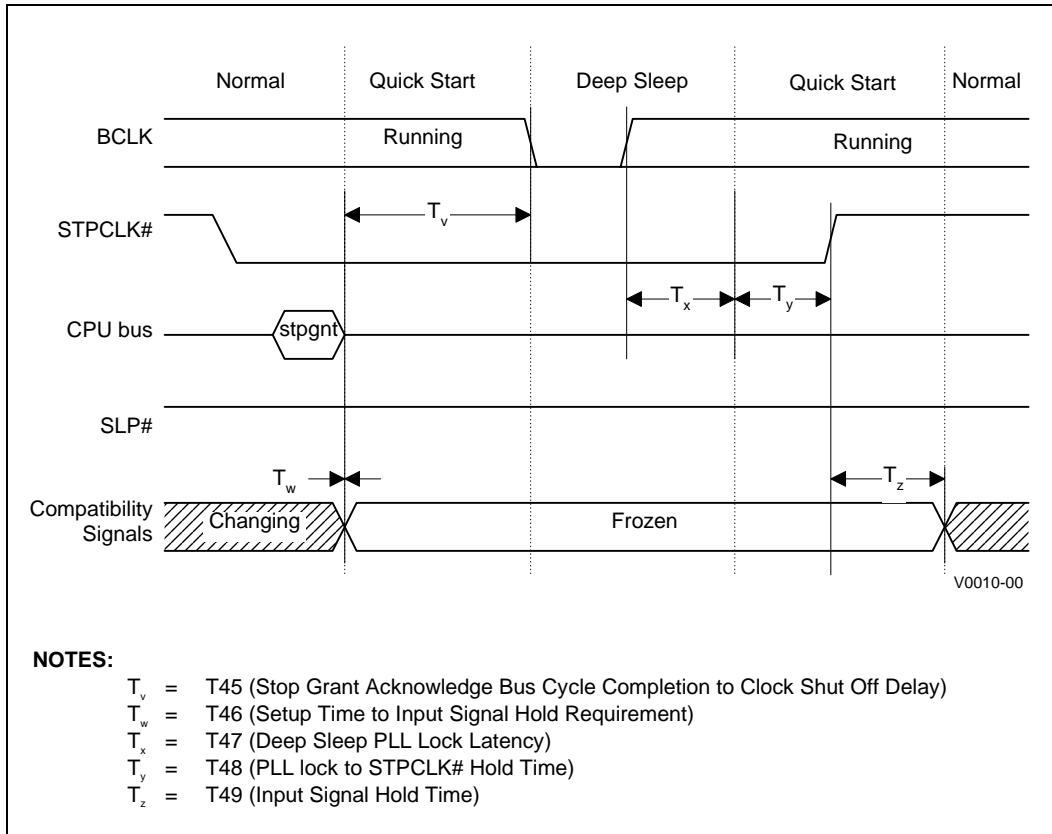

Figure 3.10 Quick Start/Deep Sleep Timing

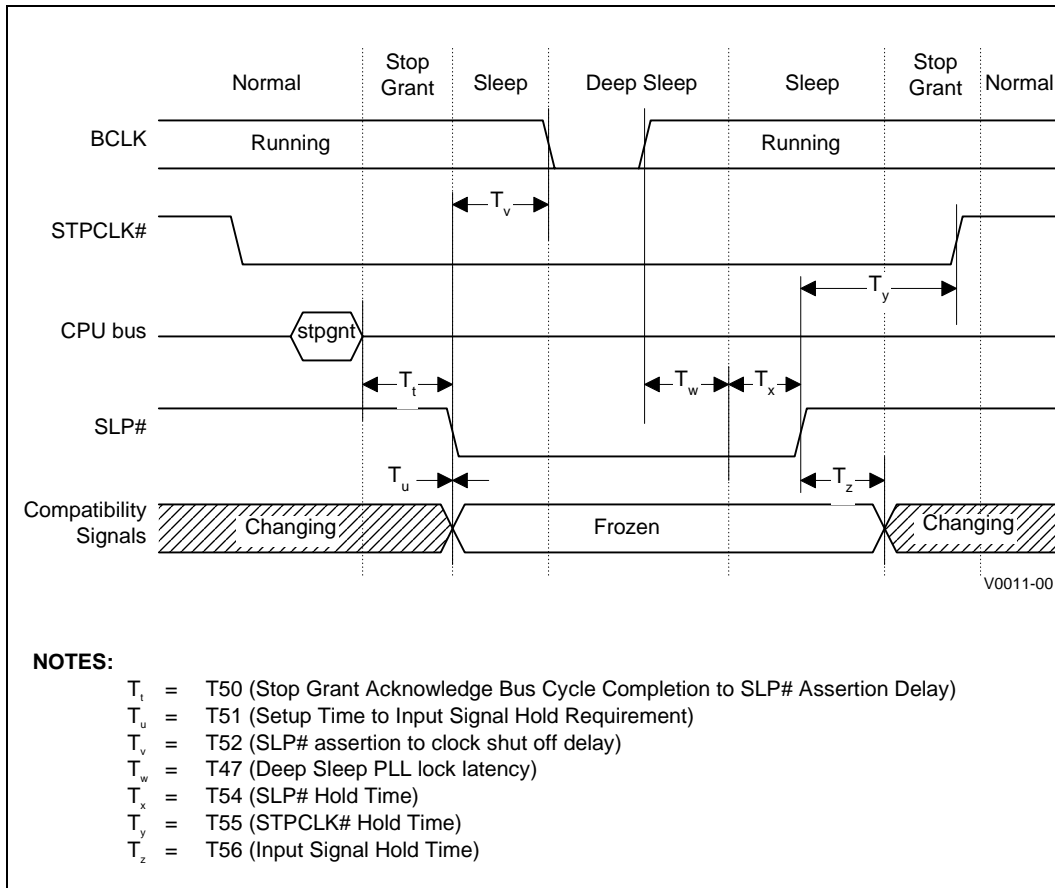

Figure 3.11 Stop Grant/Sleep/Deep Sleep Timing



4. SYSTEM SIGNAL SIMULATIONS

Many scenarios have been simulated to generate a set of Low Power GTL+ processor system bus layout guidelines which are available in the *Mobile Pentium® II Processor System Bus Layout Guideline* (Order Number 243672-001). Systems must be simulated using the IBIS models to determine if they are compliant with this specification. There are different IBIS models for the 400 MHz and for the 366 MHz and below

4.1 System Bus Clock (BCLK) Signal Quality Specifications

Table 4.1 and Figure 4.1 show the signal quality for the system bus clock (BCLK) signal as measured at the processor. The timings illustrated in Figure 4.1 are taken from Table 3.14. BCLK is a 2.5V clock.

Table 4.1 BCLK Signal Quality Specifications

Symbol	Parameter	Min	Max	Unit	Figure	Notes
V1	$V_{IL,BCLK}$		0.7	V	4.1	Note 1
V2	$V_{IH,BCLK}$	1.8		V	4.1	Note 1
V3	V_{IN} Absolute Voltage Range	-0.7	3.5	V	4.1	Undershoot, Overshoot ²
V3	V_{IN} Absolute Voltage Range	-0.8	3.5	V	4.1	Undershoot, Overshoot ³
V4	Rising Edge Ringback	1.8		V	4.1	Absolute Value ⁴
V5	Falling Edge Ringback		0.7	V	4.1	Absolute Value ⁴
	BCLK rising/falling slew rate	0.8	4	V/ns	4.1	

NOTES:

1. BCLK must rise/fall monotonically between $V_{IL,BCLK}$ and $V_{IH,BCLK}$.
2. 400 MHz processor only.
3. 366 MHz and below.
4. The rising and falling edge ringback voltage specified is the minimum (rising) or maximum (falling) absolute voltage the BCLK signal can dip back to after passing the $V_{IH,BCLK}$ (rising) or $V_{IL,BCLK}$ (falling) voltage limits.

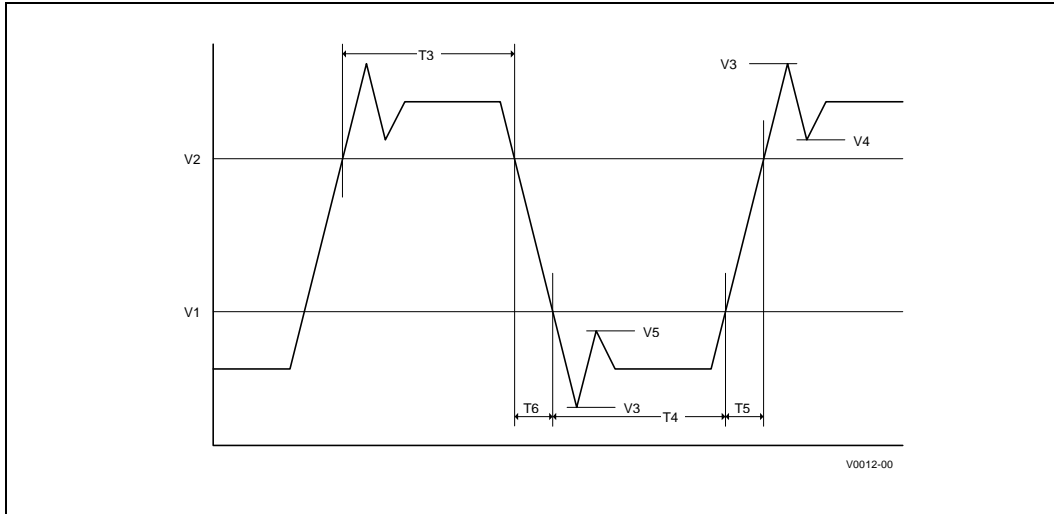

Figure 4.1 BCLK Generic Clock Waveform

4.2 Low Power GTL+ Signal Quality Specifications

Table 4.2 and Figure 4.2 illustrate the GTL+ signal quality specifications for the Mobile Pentium II processor. Refer to the *Pentium® II Processor Developer's Manual* for the GTL+ buffer specification.

The Mobile Pentium® II processor at 400 MHz also

has additional specifications on maximum allowable overshoot and undershoot for a given duration of time, as listed in Table 4.3. Contact your Intel Field Sales representative for a copy of the OVERSHOOT_CHECKER tool. OVERSHOOT_CHECKER determines if a specific waveform meets the overshoot/undershoot specification. Figure 4.3 shows the overshoot/undershoot waveform.



**MOBILE PENTIUM® II PROCESSOR IN MICRO-PGA AND BGA PACKAGES
AT 400 MHZ, 366 MHZ, 333 MHZ, 300PE MHZ, AND 266PE MHZ**

**Table 4.2 Low Power GTL+ Signal Group Ringback Specification for
the Mobile Pentium® II Processor**

Symbol	Parameter	Min	Unit	Figure	Notes
α	Overshoot	100	mV	4.2	Notes 1, 2
τ	Minimum Time at High	1	ns	4.2	Notes 1, 2
ρ	Amplitude of Ringback	-100	mV	4.2	Notes 1, 2, 3
ϕ	Final Settling Voltage	100	mV	4.2	Notes 1, 2
δ	Duration of Sequential Ringback	N/A	ns	4.2	Notes 1, 2

NOTES:

1. Specified for the edge rate of 0.3 – 0.8 V/ns. See Figure 4.2 for the generic waveform.
2. All values determined by design/characterization.
3. Ringback below $V_{REF} + 100$ mV is not authorized during low to high transitions. Ringback above $V_{REF} - 100$ mV is not authorized during high to low transitions.

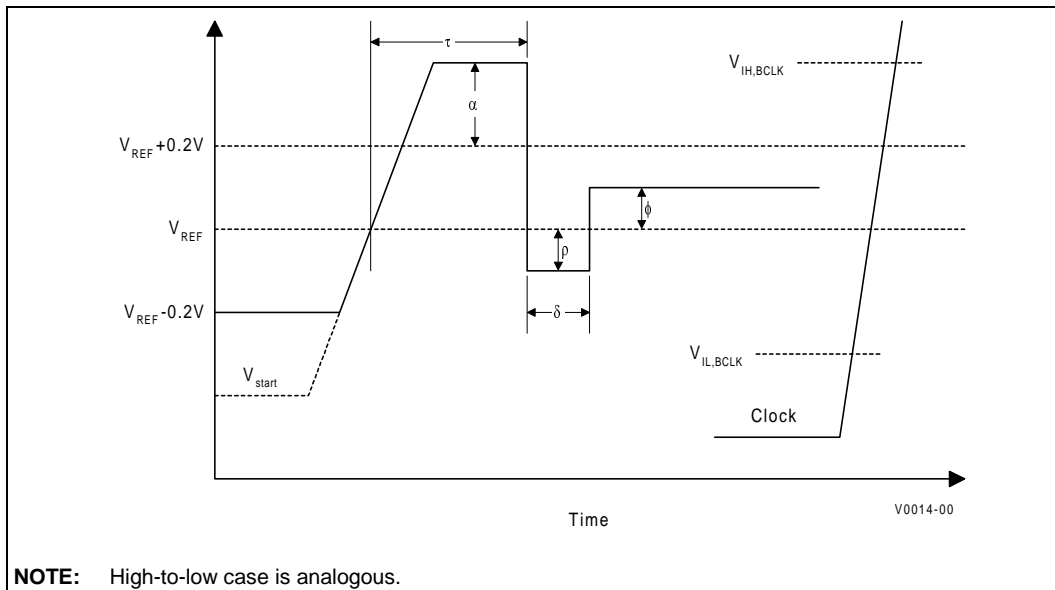

Figure 4.2 GTL+ Receiver Ringback Tolerance



Table 4.3. GTL+ Signal Group Overshoot/Undershoot Tolerance at the Processor Core ^{1, 4, 5} for the Mobile Pentium® II Processor at 400 MHz

Pulse Duration	Allowed Overshoot ²	Allowed Undershoot ³
0.1 ns	2.0V	-0.35V
0.3 ns	1.9V	-0.25V
1.0 ns	1.8V	-0.15V

NOTES:

1. Under no circumstances should the GTL+ signal voltage ever exceed 2.0V maximum with respect to ground or -2.0V minimum with respect to V_{CCT} (i.e., $V_{CCT} - 2.0V$) under operating conditions.
2. Ring-backs below V_{CCT} cannot be subtracted from overshoots. Lesser undershoot does not allocate longer or larger overshoot.
3. Ring-backs above ground cannot be subtracted from undershoots. Lesser overshoot does not allocate longer or larger undershoot.
4. System designers are encouraged to follow Intel provided GTL+ layout guidelines.
5. All values are specified by design characterization, and are not tested.

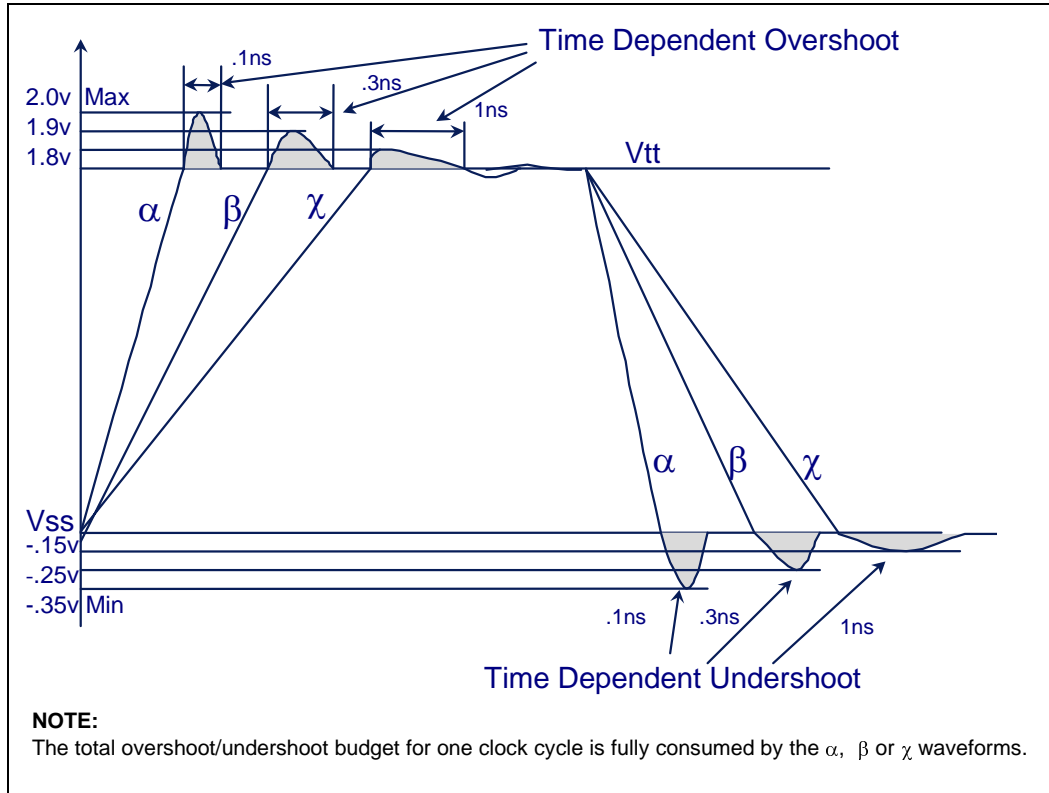

Figure 4.3 Maximum Acceptable GTL+ Overshoot/Undershoot Waveform for the Mobile Pentium® II Processor at 400 MHz

4.3 Non-Low Power GTL+ Signal Quality Specifications

Signals driven to the Mobile Pentium II processor should meet signal quality specifications to ensure that the processor reads data properly and that incoming signals do not affect the long-term

reliability of the processor. There are three signal quality parameters defined: overshoot/undershoot, ringback and settling limit. The ringback and settling limit signal quality parameters are shown in Figure 4.4 for non-GTL+ signal groups. The overshoot and undershoot specifications for non-GTL+ signals are the same as for GTL+ signals; see Section 4.2.

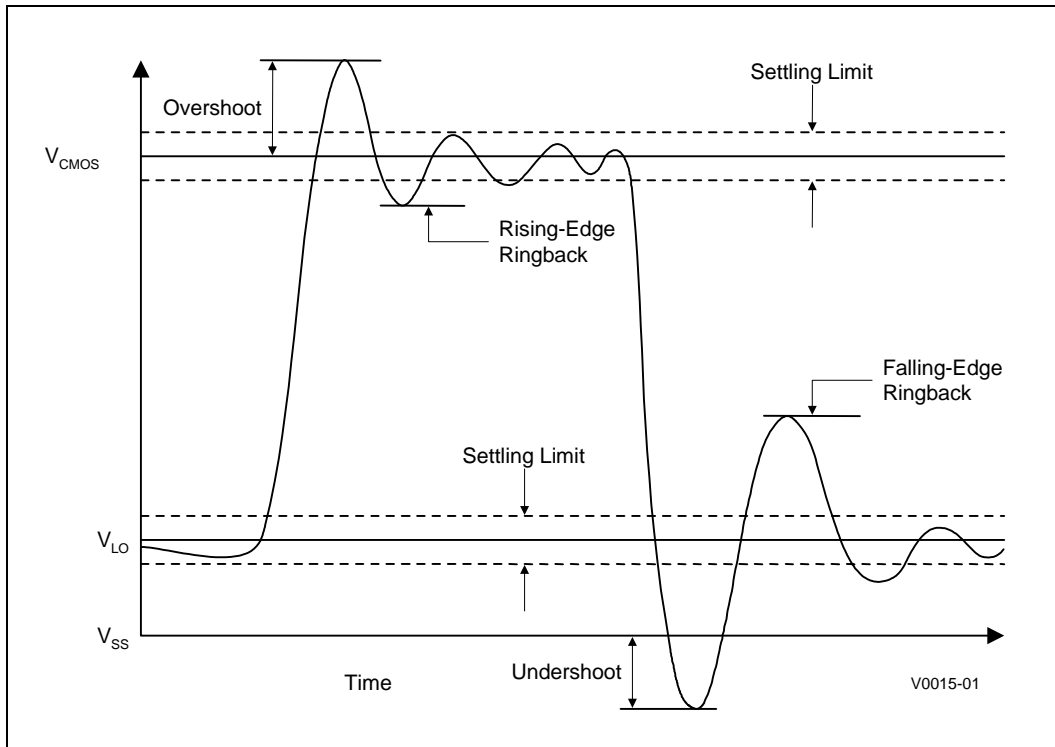

Figure 4.4 Non-GTL+ Signal Ringback and Settling Limit

4.3.1 Overshoot and Undershoot Guidelines

Overshoot (or undershoot) is the absolute value of the maximum voltage above the nominal high voltage or below V_{SS} . The overshoot/undershoot guideline limits transitions beyond V_{CC} or V_{SS} due to the fast signal edge rates. The processor can be damaged by repeated overshoot events on V_{CMOS} tolerant buffers if the charge is large enough (i.e., if the overshoot is great enough).

However, excessive ringback is the dominant detrimental system timing effect resulting from overshoot/undershoot (i.e., violating the overshoot/undershoot guideline will make it difficult to satisfy the ringback specification). The overshoot/undershoot guideline is 0.7V for the 400 MHz, 0.8V for the 366 MHz and below and assumes the absence of diodes on the input. These guidelines should be verified in simulations *without the on-chip ESD protection diodes present* because the diodes will begin clamping the V_{CMOS} tolerant signals beginning at approximately 1.25V above V_{CC} and 0.5V below V_{SS} . If the signals do not reach the clamping voltage, then this will not be an issue. A



system should not rely on the diodes for overshoot/undershoot protection as this will negatively affect the life of the components and

make meeting the ringback specification very difficult.

4.3.1 Ringback Specification

Ringback refers to the amount of reflection seen after a signal has switched. The ringback specification is the voltage to which the signal rings back after achieving its maximum absolute value. Excessive ringback can cause false signal detection or extend the propagation delay. The ringback specification applies to the input signal of each receiving agent. Violations of the signal ringback specification are not allowed under any circumstances for the non-GTL+ signals.

Ringback can be simulated with or without the input protection diodes that can be added to the input buffer model. However, signals that reach the clamping voltage should be evaluated further. See Table 4.4 for the signal ringback specifications for non-GTL+ signals.

4.3.2 Settling Limit Guideline

Settling limit defines the maximum amount of ringing at the receiving signal that a signal may reach before its next transition. The amount allowed is 10% of the total signal swing ($V_{HI} - V_{LO}$) above and below its final value. A signal should be within the settling limits of its final value, when either in its high state or low state, before its next transition.

Signals that are not within their settling limit before transitioning are at risk of unwanted oscillations that could jeopardize signal integrity. Simulations to verify settling limit may be done either with or without the input protection diodes present. Violation of the settling limit guideline is acceptable if simulations of 5 to 10 successive transitions do not show the amplitude of the ringing increasing in the subsequent transitions.

Table 4.4 Signal Ringback Specifications for Non-GTL+ Signals for the Mobile Pentium® II Processor at 400 MHz

Input Signal Group	Transition	Maximum Ringback (with Input Diodes Present)	Figure
Non-GTL+ Signals	0 → 1	1.135 V	4.4
Non-GTL+ Signals	1 → 0	0.600 V	4.4

Table 4.5 Signal Ringback Specifications for Non-GTL+ Signals for the Mobile Pentium® II Processor at 366 MHz and Below

Input Signal Group	Transition	Maximum Ringback (with Input Diodes Present)	Figure
Non-GTL+ Signals	0 → 1	1.700 V	4.4
Non-GTL+ Signals	1 → 0	0.700 V	4.4



5. MECHANICAL SPECIFICATIONS

The Mobile Pentium® II processor are available in a PPGA-B615 package (also known as Micro-PGA) or in a PBGA-B615 package (also known as BGA). The back of the processor die exposed on top of both packages. This section contains information describing the packages and the signal pin assignments.

5.1 Dimensions of the Micro-PGA Package

The Micro-PGA dimensions are given in Table 5.1, and shown in Figure 5.1 and Figure 5.2. For component handling, the substrate may only be contacted within the region between the keepout outline and the edge of the substrate.

Table 5.1 Micro-PGA Package Mechanical Specifications

Symbol	Parameter	Min	Max	Unit
A	Overall Height, top of die to seating plane of the interposer	3.23	3.83	mm
A ₁	Pin length	1.25 REF		mm
A ₂	Die Height	0.854 REF		mm
B	Pin Diameter	0.30 REF		mm
D	Die Substrate Width	30.85	31.15	mm
D ₁	Die Width	10.36 REF		mm
D ₂	Package Width	32.60 REF		mm
E	Die Substrate Length	34.85	35.15	mm
E ₁	Die Length	17.36 REF		mm
E ₂	Package Length	36.80 REF		mm
e	Pin pitch	1.27		
—	Pin Tip Radial True Position	<=1.27		
N	Pin Count	615		each
S ₁	Pin row A to short edge of interposer	2.220 REF		mm
S ₂	Pin column 1 to long edge of interposer	1.415 REF		mm
P _{DIE}	Allowable Pressure on the Die for Thermal Solution	—	689	kPa
W	Package Weight	7.5 REF		grams



**MOBILE PENTIUM® II PROCESSOR IN MICRO-PGA AND BGA PACKAGES
AT 400 MHZ, 366 MHZ, 333 MHZ, 300PE MHZ, AND 266PE MHZ**

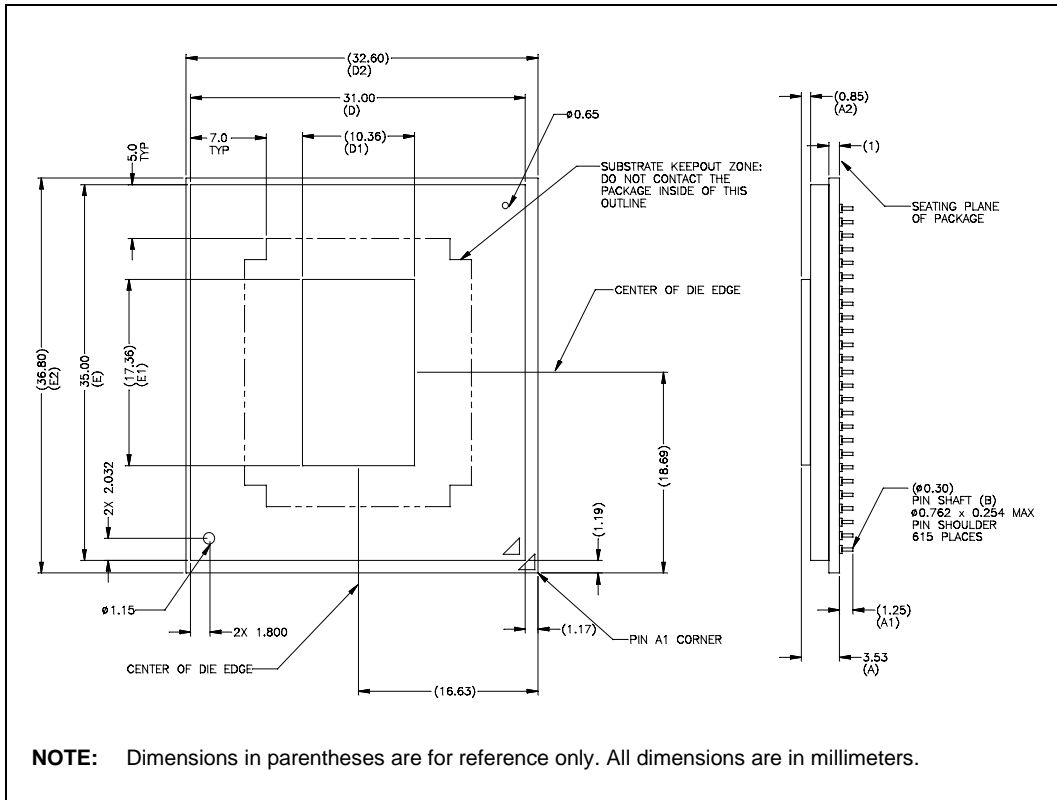

Figure 5.1 Micro-PGA Package-Top and Side View

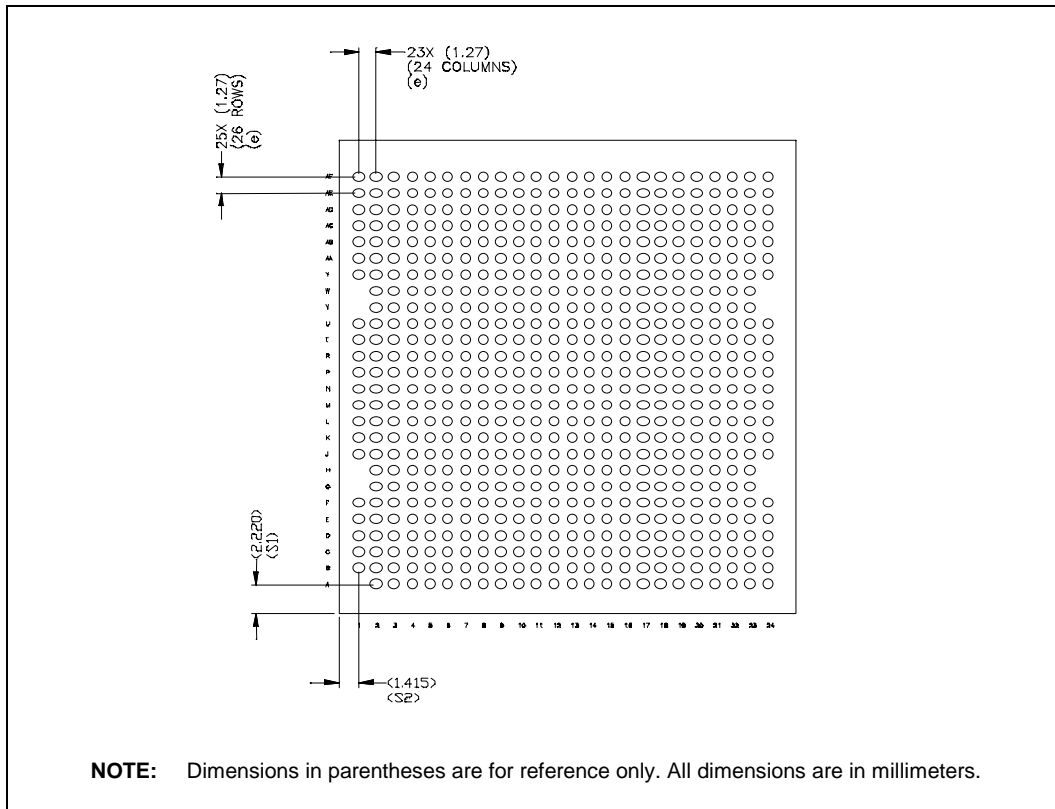

Figure 5.2 Micro-PGA Package - Bottom View

5.2 Dimensions of the BGA Package

The mechanical specifications for the surface-mount package are provided in Table 5.2. Figure 5.3 shows the top and side views of the surface-mount

package and, and Figure 5.4 shows the bottom view of the surface-mount package. For component handling, the substrate may only be contacted within the shaded region between the keepout outline and the edge of the substrate.



**MOBILE PENTIUM® II PROCESSOR IN MICRO-PGA AND BGA PACKAGES
AT 400 MHZ, 366 MHZ, 333 MHZ, 300PE MHZ, AND 266PE MHZ**

Table 5.2 Surface-Mount BGA Package Specifications

Symbol	Parameter	Min	Max	Unit
A	Overall Height, as delivered (USE THIS FOR 5.2)	2.29	2.79	mm
A ₁	Substrate Height, as delivered	1.50 REF		mm
A ₂	Die Height	0.854 REF		mm
b	Ball Diameter	0.78 REF		mm
D	Package Width	30.85	31.15	mm
D ₁	Die Width	10.36 REF		mm
E	Package Length	34.85	35.15	mm
e	Ball Pitch	1.27		mm
E ₁	Die Length	17.36 REF		mm
N	Ball Count	615		each
S ₁	Outer Ball Center to Short Edge of Substrate	1.625 REF		mm
S ₂	Outer Ball Center to Long Edge of Substrate	0.895 REF		mm
P _{DIE}	Allowable Pressure on the Die for Thermal Solution	—	689	kPa
W	Package Weight	3.71	4.52	grams



**MOBILE PENTIUM® II PROCESSOR IN MICRO-PGA AND BGA PACKAGES
AT 400 MHZ, 366 MHZ, 333 MHZ, 300PE MHZ, AND 266PE MHZ**

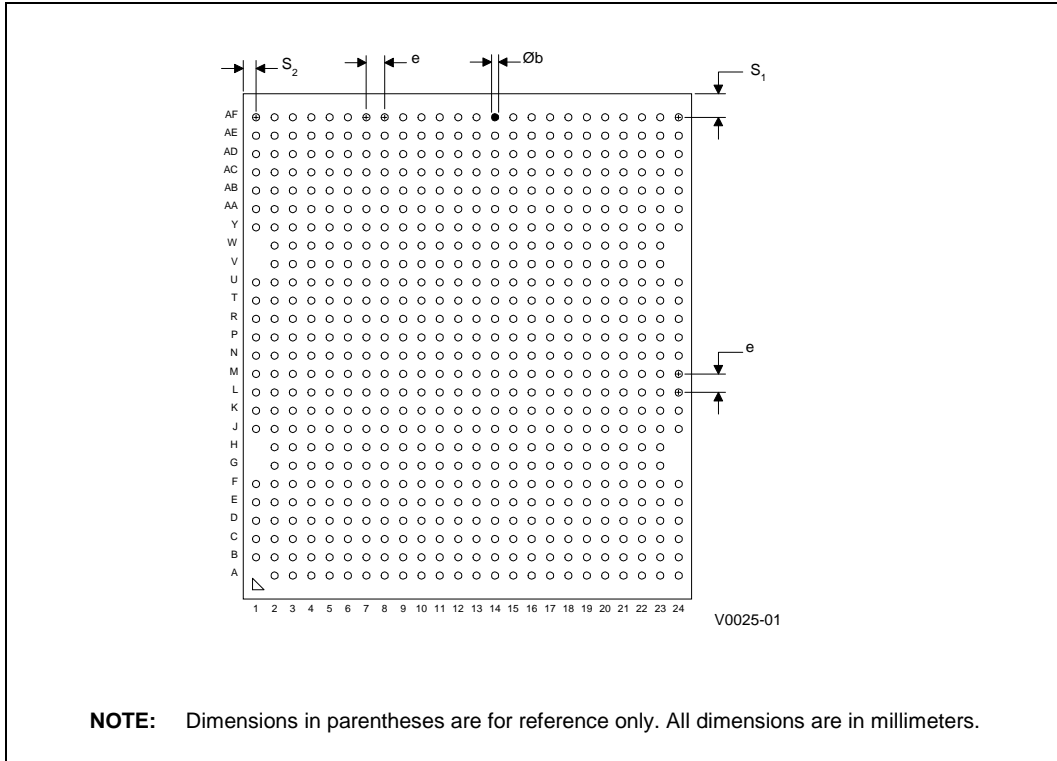

Figure 5.4 Surface-Mount BGA Package - Bottom View

5.3 Signal Listings

Figure 5.5 is a topside view of the ball/pin map of the Mobile Pentium® II processor with the voltage

pins/balls called out. Table 5.3 lists the signals in pin/ball number order. Table 5.4 and Table 5.5 list the signals in signal name order.

MOBILE PENTIUM® II PROCESSOR IN MICRO-PGA AND BGA PACKAGES
 AT 400 MHZ, 366 MHZ, 333 MHZ, 300PE MHZ, AND 266PE MHZ

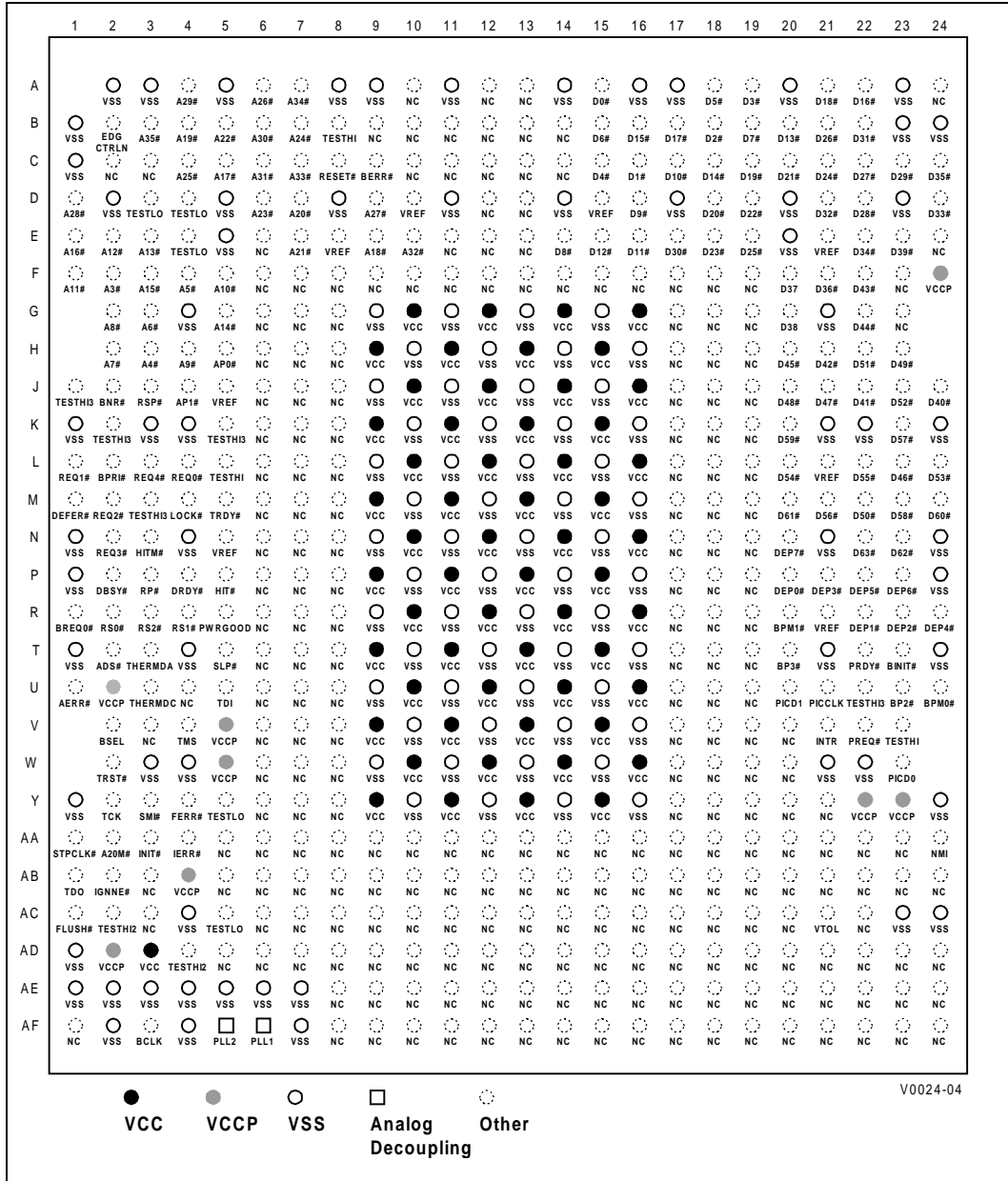

Figure 5.5 Pin/Ball Map - Top View



MOBILE PENTIUM® II PROCESSOR IN MICRO-PGA AND BGA PACKAGES
AT 400 MHZ, 366 MHZ, 333 MHZ, 300PE MHZ, AND 266PE MHZ

Table 5.3 Signal Listing in Order by Pin/Ball Number

No.	Signal Name	No.	Signal Name	No.	Signal Name	No.	Signal Name
A2	VSS	B8	TESTHI	C14	NC	D20	VSS
A3	VSS	B9	NC	C15	D4#	D21	D32#
A4	A29#	B10	NC	C16	D1#	D22	D28#
A5	VSS	B11	NC	C17	D10#	D23	VSS
A6	A26#	B12	NC	C18	D14#	D24	D33#
A7	A34#	B13	NC	C19	D19#	E1	A16#
A8	VSS	B14	NC	C20	D21#	E2	A12#
A9	VSS	B15	D6#	C21	D24#	E3	A13#
A10	NC	B16	D15#	C22	D27#	E4	TESTLO
A11	VSS	B17	D17#	C23	D29#	E5	VSS
A12	NC	B18	D2#	C24	D35#	E6	NC
A13	NC	B19	D7#	D1	A28#	E7	A21#
A14	VSS	B20	D13#	D2	VSS	E8	VREF
A15	D0#	B21	D26#	D3	TESTLO	E9	A18#
A16	VSS	B22	D31#	D4	TESTLO	E10	A32#
A17	VSS	B23	VSS	D5	VSS	E11	NC
A18	D5#	B24	VSS	D6	A23#	E12	NC
A19	D3#	C1	VSS	D7	A20#	E13	NC
A20	VSS	C2	NC	D8	VSS	E14	D8#
A21	D18#	C3	NC	D9	A27#	E15	D12#
A22	D16#	C4	A25#	D10	VREF	E16	D11#
A23	VSS	C5	A17#	D11	VSS	E17	D30#
A24	NC	C6	A31#	D12	NC	E18	D23#
B1	VSS	C7	A33#	D13	NC	E19	D25#
B2	EDGCTRLN	C8	RESET#	D14	VSS	E20	VSS
B3	A35#	C9	BERR#	D15	VREF	E21	VREF
B4	A19#	C10	NC	D16	D9#	E22	D34#
B5	A22#	C11	NC	D17	VSS	E23	D39#
B6	A30#	C12	NC	D18	D20#	E24	NC
B7	A24#	C13	NC	D19	D22#	F1	A11#



Table 5.3 Signal Listing in Order by Pin/Ball Number

No.	Signal Name	No.	Signal Name	No.	Signal Name	No.	Signal Name
F2	A3#	G8	NC	H15	VCC	J21	D47#
F3	A15#	G9	VSS	H16	VSS	J22	D41#
F4	A5#	G10	VCC	H17	NC	J23	D52#
F5	A10#	G11	VSS	H18	NC	J24	D40#
F6	NC	G12	VCC	H19	NC	K1	VSS
F7	NC	G13	VSS	H20	D45#	K2	TESTHI3
F8	NC	G14	VCC	H21	D42#	K3	VSS
F9	NC	G15	VSS	H22	D51#	K4	VSS
F10	NC	G16	VCC	H23	D49#	K5	TESTHI3
F11	NC	G17	NC	J1	TESTHI3	K6	NC
F12	NC	G18	NC	J2	BNR#	K7	NC
F13	NC	G19	NC	J3	RSP#	K8	NC
F14	NC	G20	D38#	J4	AP1#	K9	VCC
F15	NC	G21	VSS	J5	VREF	K10	VSS
F16	NC	G22	D44#	J6	NC	K11	VCC
F17	NC	G23	NC	J7	NC	K12	VSS
F18	NC	H2	A7#	J8	NC	K13	VCC
F19	NC	H3	A4#	J9	VSS	K14	VSS
F20	D37#	H4	A9#	J10	VCC	K15	VCC
F21	D36#	H5	AP0#	J11	VSS	K16	VSS
F22	D43#	H6	NC	J12	VCC	K17	NC
F23	NC	H7	NC	J13	VSS	K18	NC
F24	VCCP	H8	NC	J14	VCC	K19	NC
G2	A8#	H9	VCC	J15	VSS	K20	D59#
G3	A6#	H10	VSS	J16	VCC	K21	VSS
G4	VSS	H11	VCC	J17	NC	K22	VSS
G5	A14#	H12	VSS	J18	NC	K23	D57#
G6	NC	H13	VCC	J19	NC	K24	VSS
G7	NC	H14	VSS	J20	D48#	L1	REQ1#



**MOBILE PENTIUM® II PROCESSOR IN MICRO-PGA AND BGA PACKAGES
AT 400 MHZ, 366 MHZ, 333 MHZ, 300PE MHZ, AND 266PE MHZ**

Table 5.3 Signal Listing in Order by Pin/Ball Number

No.	Signal Name	No.	Signal Name	No.	Signal Name	No.	Signal Name
L2	BPRI#	M8	NC	N14	VCC	P20	DEP0#
L3	REQ4#	M9	VCC	N15	VSS	P21	DEP3#
L4	REQ0#	M10	VSS	N16	VCC	P22	DEP5#
L5	TESTHI	M11	VCC	N17	NC	P23	DEP6#
L6	NC	M12	VSS	N18	NC	P24	VSS
L7	NC	M13	VCC	N19	NC	R1	BREQ0#
L8	NC	M14	VSS	N20	DEP7#	R2	RS0#
L9	VSS	M15	VCC	N21	VSS	R3	RS2#
L10	VCC	M16	VSS	N22	D63#	R4	RS1#
L11	VSS	M17	NC	N23	D62#	R5	PWRGOOD
L12	VCC	M18	NC	N24	VSS	R6	NC
L13	VSS	M19	NC	P1	VSS	R7	NC
L14	VCC	M20	D61#	P2	DBSY#	R8	NC
L15	VSS	M21	D56#	P3	RP#	R9	VSS
L16	VCC	M22	D50#	P4	DRDY#	R10	VCC
L17	NC	M23	D58#	P5	HIT#	R11	VSS
L18	NC	M24	D60#	P6	NC	R12	VCC
L19	NC	N1	VSS	P7	NC	R13	VSS
L20	D54#	N2	REQ3#	P8	NC	R14	VCC
L21	VREF	N3	HITM#	P9	VCC	R15	VSS
L22	D55#	N4	VSS	P10	VSS	R16	VCC
L23	D46#	N5	VREF	P11	VCC	R17	NC
L24	D53#	N6	NC	P12	VSS	R18	NC
M1	DEFER#	N7	NC	P13	VCC	R19	NC
M2	REQ2#	N8	NC	P14	VSS	R20	BPM1#
M3	TESTHI3	N9	VSS	P15	VCC	R21	VREF
M4	LOCK#	N10	VCC	P16	VSS	R22	DEP1#
M5	TRDY#	N11	VSS	P17	NC	R23	DEP2#
M6	NC	N12	VCC	P18	NC	R24	DEP4#
M7	NC	N13	VSS	P19	NC	T1	VSS



Table 5.3 Signal Listing in Order by Pin/Ball Number

No.	Signal Name	No.	Signal Name	No.	Signal Name	No.	Signal Name
T2	ADS#	U8	NC	V15	VCC	W23	PICD0
T3	THERMDA	U9	VSS	V16	VSS	Y1	VSS
T4	VSS	U10	VCC	V17	NC	Y2	TCK
T5	SLP#	U11	VSS	V18	NC	Y3	SMI#
T6	NC	U12	VCC	V19	NC	Y4	FERR#
T7	NC	U13	VSS	V20	NC	Y5	TESTLO
T8	NC	U14	VCC	V21	INTR	Y6	NC
T9	VCC	U15	VSS	V22	PREQ#	Y7	NC
T10	VSS	U16	VCC	V23	TESTHI	Y8	NC
T11	VCC	U17	NC	W2	TRST#	Y9	VCC
T12	VSS	U18	NC	W3	VSS	Y10	VSS
T13	VCC	U19	NC	W4	VSS	Y11	VCC
T14	VSS	U20	PICD1	W5	VCCP	Y12	VSS
T15	VCC	U21	PICCLK	W6	NC	Y13	VCC
T16	VSS	U22	TESTHI3	W7	NC	Y14	VSS
T17	NC	U23	BP2#	W8	NC	Y15	VCC
T18	NC	U24	BPM0#	W9	VSS	Y16	VSS
T19	NC	V2	BSEL	W10	VCC	Y17	NC
T20	BP3#	V3	NC	W11	VSS	Y18	NC
T21	VSS	V4	TMS	W12	VCC	Y19	NC
T22	PRDY#	V5	VCCP	W13	VSS	Y20	NC
T23	BINIT#	V6	NC	W14	VCC	Y21	NC
T24	VSS	V7	NC	W15	VSS	Y22	VCCP
U1	AERR#	V8	NC	W16	VCC	Y23	VCCP
U2	VCCP	V9	VCC	W17	NC	Y24	VSS
U3	THERMDC	V10	VSS	W18	NC	AA1	STPCLK#
U4	NC	V11	VCC	W19	NC	AA2	A20M#
U5	TDI	V12	VSS	W20	NC	AA3	INIT#
U6	NC	V13	VCC	W21	VSS	AA4	IERR#
U7	NC	V14	VSS	W22	VSS	AA5	NC



**MOBILE PENTIUM® II PROCESSOR IN MICRO-PGA AND BGA PACKAGES
AT 400 MHZ, 366 MHZ, 333 MHZ, 300PE MHZ, AND 266PE MHZ**

Table 5.3 Signal Listing in Order by Pin/Ball Number

No.	Signal Name	No.	Signal Name	No.	Signal Name	No.	Signal Name
AA6	NC	AB12	NC	AC18	NC	AD24	NC
AA7	NC	AB13	NC	AC19	NC	AE1	VSS
AA8	NC	AB14	NC	AC20	NC	AE2	VSS
AA9	NC	AB15	NC	AC21	VTOL	AE3	VSS
AA10	NC	AB16	NC	AC22	NC	AE4	VSS
AA11	NC	AB17	NC	AC23	VSS	AE5	VSS
AA12	NC	AB18	NC	AC24	VSS	AE6	VSS
AA13	NC	AB19	NC	AD1	VSS	AE7	VSS
AA14	NC	AB20	NC	AD2	VCCP	AE8	NC
AA15	NC	AB21	NC	AD3	VCC	AE9	NC
AA16	NC	AB22	NC	AD4	TESTHI2	AE10	NC
AA17	NC	AB23	NC	AD5	NC	AE11	NC
AA18	NC	AB24	NC	AD6	NC	AE12	NC
AA19	NC	AC1	FLUSH#	AD7	NC	AE13	NC
AA20	NC	AC2	TESTHI2	AD8	NC	AE14	NC
AA21	NC	AC3	NC	AD9	NC	AE15	NC
AA22	NC	AC4	VSS	AD10	NC	AE16	NC
AA23	NC	AC5	TESTLO	AD11	NC	AE17	NC
AA24	NMI	AC6	NC	AD12	NC	AE18	NC
AB1	TDO	AC7	NC	AD13	NC	AE19	NC
AB2	IGNNE#	AC8	NC	AD14	NC	AE20	NC
AB3	NC	AC9	NC	AD15	NC	AE21	NC
AB4	VCCP	AC10	NC	AD16	NC	AE22	NC
AB5	NC	AC11	NC	AD17	NC	AE23	NC
AB6	NC	AC12	NC	AD18	NC	AE24	NC
AB7	NC	AC13	NC	AD19	NC	AF1	NC
AB8	NC	AC14	NC	AD20	NC	AF2	VSS
AB9	NC	AC15	NC	AD21	NC	AF3	BCLK
AB10	NC	AC16	NC	AD22	NC	AF4	VSS
AB11	NC	AC17	NC	AD23	NC	AF5	PLL2



Table 5.3 Signal Listing in Order by Pin/Ball Number

No.	Signal Name	No.	Signal Name	No.	Signal Name	No.	Signal Name
AF6	PLL1	AF11	NC	AF16	NC	AF21	NC
AF7	VSS	AF12	NC	AF17	NC	AF22	NC
AF8	NC	AF13	NC	AF18	NC	AF23	NC
AF9	NC	AF14	NC	AF19	NC	AF24	NC
AF10	NC	AF15	NC	AF20	NC		



**MOBILE PENTIUM® II PROCESSOR IN MICRO-PGA AND BGA PACKAGES
AT 400 MHZ, 366 MHZ, 333 MHZ, 300PE MHZ, AND 266PE MHZ**

Table 5.4 Signal Listing in Order by Signal Name					
No.	Signal Name	Signal Buffer Type	No.	Signal Name	Signal Buffer Type
F2	A3#	Low Power GTL+ I/O	C7	A33#	Low Power GTL+ I/O
H3	A4#	Low Power GTL+ I/O	A7	A34#	Low Power GTL+ I/O
F4	A5#	Low Power GTL+ I/O	B3	A35#	Low Power GTL+ I/O
G3	A6#	Low Power GTL+ I/O	AA2	A20M#	CMOS Input
H2	A7#	Low Power GTL+ I/O	T2	ADS#	Low Power GTL+ I/O
G2	A8#	Low Power GTL+ I/O	U1	AERR#	Low Power GTL+ I/O
H4	A9#	Low Power GTL+ I/O	H5	AP0#	Low Power GTL+ I/O
F5	A10#	Low Power GTL+ I/O	J4	AP1#	Low Power GTL+ I/O
F1	A11#	Low Power GTL+ I/O	AF3	BCLK	Processor Clock Input
E2	A12#	Low Power GTL+ I/O	C9	BERR#	Low Power GTL+ I/O
E3	A13#	Low Power GTL+ I/O	T23	BINIT#	Low Power GTL+ I/O
G5	A14#	Low Power GTL+ I/O	J2	BNR#	Low Power GTL+ I/O
F3	A15#	Low Power GTL+ I/O	U23	BP2#	Low Power GTL+ I/O
E1	A16#	Low Power GTL+ I/O	T20	BP3#	Low Power GTL+ I/O
C5	A17#	Low Power GTL+ I/O	U24	BPM0#	Low Power GTL+ I/O
E9	A18#	Low Power GTL+ I/O	R20	BPM1#	Low Power GTL+ I/O
B4	A19#	Low Power GTL+ I/O	L2	BPRI#	Low Power GTL+ Input
D7	A20#	Low Power GTL+ I/O	R1	BREQ0#	Low Power GTL+ I/O
E7	A21#	Low Power GTL+ I/O	V2	BSEL	CMOS Input
B5	A22#	Low Power GTL+ I/O	A15	D0#	Low Power GTL+ I/O
D6	A23#	Low Power GTL+ I/O	C16	D1#	Low Power GTL+ I/O
B7	A24#	Low Power GTL+ I/O	B18	D2#	Low Power GTL+ I/O
C4	A25#	Low Power GTL+ I/O	A19	D3#	Low Power GTL+ I/O
A6	A26#	Low Power GTL+ I/O	C15	D4#	Low Power GTL+ I/O
D9	A27#	Low Power GTL+ I/O	A18	D5#	Low Power GTL+ I/O
D1	A28#	Low Power GTL+ I/O	B15	D6#	Low Power GTL+ I/O
A4	A29#	Low Power GTL+ I/O	B19	D7#	Low Power GTL+ I/O
B6	A30#	Low Power GTL+ I/O	E14	D8#	Low Power GTL+ I/O
C6	A31#	Low Power GTL+ I/O	D16	D9#	Low Power GTL+ I/O
E10	A32#	Low Power GTL+ I/O	C17	D10#	Low Power GTL+ I/O



Table 5.4 Signal Listing in Order by Signal Name

No.	Signal Name	Signal Buffer Type	No.	Signal Name	Signal Buffer Type
E16	D11#	Low Power GTL+ I/O	J22	D41#	Low Power GTL+ I/O
E15	D12#	Low Power GTL+ I/O	H21	D42#	Low Power GTL+ I/O
B20	D13#	Low Power GTL+ I/O	F22	D43#	Low Power GTL+ I/O
C18	D14#	Low Power GTL+ I/O	G22	D44#	Low Power GTL+ I/O
B16	D15#	Low Power GTL+ I/O	H20	D45#	Low Power GTL+ I/O
A22	D16#	Low Power GTL+ I/O	L23	D46#	Low Power GTL+ I/O
B17	D17#	Low Power GTL+ I/O	J21	D47#	Low Power GTL+ I/O
A21	D18#	Low Power GTL+ I/O	J20	D48#	Low Power GTL+ I/O
C19	D19#	Low Power GTL+ I/O	H23	D49#	Low Power GTL+ I/O
D18	D20#	Low Power GTL+ I/O	M22	D50#	Low Power GTL+ I/O
C20	D21#	Low Power GTL+ I/O	H22	D51#	Low Power GTL+ I/O
D19	D22#	Low Power GTL+ I/O	J23	D52#	Low Power GTL+ I/O
E18	D23#	Low Power GTL+ I/O	L24	D53#	Low Power GTL+ I/O
C21	D24#	Low Power GTL+ I/O	L20	D54#	Low Power GTL+ I/O
E19	D25#	Low Power GTL+ I/O	L22	D55#	Low Power GTL+ I/O
B21	D26#	Low Power GTL+ I/O	M21	D56#	Low Power GTL+ I/O
C22	D27#	Low Power GTL+ I/O	K23	D57#	Low Power GTL+ I/O
D22	D28#	Low Power GTL+ I/O	M23	D58#	Low Power GTL+ I/O
C23	D29#	Low Power GTL+ I/O	K20	D59#	Low Power GTL+ I/O
E17	D30#	Low Power GTL+ I/O	M24	D60#	Low Power GTL+ I/O
B22	D31#	Low Power GTL+ I/O	M20	D61#	Low Power GTL+ I/O
D21	D32#	Low Power GTL+ I/O	N23	D62#	Low Power GTL+ I/O
D24	D33#	Low Power GTL+ I/O	N22	D63#	Low Power GTL+ I/O
E22	D34#	Low Power GTL+ I/O	P2	DBSY#	Low Power GTL+ I/O
C24	D35#	Low Power GTL+ I/O	M1	DEFER#	Low Power GTL+ Input
F21	D36#	Low Power GTL+ I/O	P20	DEP0#	Low Power GTL+ I/O
F20	D37#	Low Power GTL+ I/O	R22	DEP1#	Low Power GTL+ I/O
G20	D38#	Low Power GTL+ I/O	R23	DEP2#	Low Power GTL+ I/O
E23	D39#	Low Power GTL+ I/O	P21	DEP3#	Low Power GTL+ I/O
J24	D40#	Low Power GTL+ I/O	R24	DEP4#	Low Power GTL+ I/O



**MOBILE PENTIUM® II PROCESSOR IN MICRO-PGA AND BGA PACKAGES
AT 400 MHZ, 366 MHZ, 333 MHZ, 300PE MHZ, AND 266PE MHZ**

Table 5.4 Signal Listing in Order by Signal Name					
No.	Signal Name	Signal Buffer Type	No.	Signal Name	Signal Buffer Type
P22	DEP5#	Low Power GTL+ I/O	R2	RS0#	Low Power GTL+ Input
P23	DEP6#	Low Power GTL+ I/O	R4	RS1#	Low Power GTL+ Input
N20	DEP7#	Low Power GTL+ I/O	R3	RS2#	Low Power GTL+ Input
P4	DRDY#	Low Power GTL+ I/O	J3	RSP#	Low Power GTL+ Input
B2	EDGCTRLN	Low Power GTL+ Control	T5	SLP#	CMOS Input
Y4	FERR#	Open Drain Output	Y3	SMI#	CMOS Input
AC1	FLUSH#	CMOS Input	AA1	STPCLK#	CMOS Input
P5	HIT#	Low Power GTL+ I/O	Y2	TCK	JTAG Clock Input
N3	HITM#	Low Power GTL+ I/O	U5	TDI	JTAG Input
AA4	IERR#	Open Drain Output	AB1	TDO	JTAG Output
AB2	IGNNE#	CMOS Input	B8	TESTHI	GTL+ Test Input
AA3	INIT#	CMOS Input	L5	TESTHI	GTL+ Test Input
V21	INTR	CMOS Input	V23	TESTHI	GTL+ Test Input
M4	LOCK#	Low Power GTL+ I/O	AC2	TESTHI2	CMOS Test Input
AA24	NMI	CMOS Input	AD4	TESTHI2	CMOS Test Input
U21	PICCLK	APIC Clock Input	J1	TESTHI3	GTL+ Test Input
W23	PICD0	Open Drain I/O	K2	TESTHI3	GTL+ Test Input
U20	PICD1	Open Drain I/O	K5	TESTHI3	GTL+ Test Input
AF6	PLL1	PLL Analog Voltage	M3	TESTHI3	GTL+ Test Input
AF5	PLL2	PLL Analog Voltage	U22	TESTHI3	GTL+ Test Input
T22	PRDY#	Low Power GTL+ Output	D3	TESTLO	Test Input
V22	PREQ#	CMOS Input	D4	TESTLO	Test Input
R5	PWRGOOD	CMOS Input	E4	TESTLO	Test Input
L4	REQ0#	Low Power GTL+ I/O	Y5	TESTLO	Test Input
L1	REQ1#	Low Power GTL+ I/O	AC5	TESTLO	Test Input
M2	REQ2#	Low Power GTL+ I/O	T3	THERMDA	Thermal Diode Anode
N2	REQ3#	Low Power GTL+ I/O	U3	THERMDC	Thermal Diode Cathode
L3	REQ4#	Low Power GTL+ I/O	V4	TMS	JTAG Input
C8	RESET#	Low Power GTL+ Input	M5	TRDY#	Low Power GTL+ Input
P3	RP#	Low Power GTL+ I/O	J5	VREF	GTL+ Reference Voltage



Table 5.4 Signal Listing in Order by Signal Name

No.	Signal Name	Signal Buffer Type	No.	Signal Name	Signal Buffer Type
D10	VREF	GTL+ Reference Voltage	L21	VREF	GTL+ Reference Voltage
D15	VREF	GTL+ Reference Voltage	N5	VREF	GTL+ Reference Voltage
E8	VREF	GTL+ Reference Voltage	R21	VREF	GTL+ Reference Voltage
E21	VREF	GTL+ Reference Voltage	AC21	VTOL	Voltage Tolerance
W2	TRST#	JTAG Input			

NOTE: Except for BCLK, the CMOS signals are 1.5V tolerant for 400 MHz; and 2.5V tolerant for 366 MHz and below.



**MOBILE PENTIUM® II PROCESSOR IN MICRO-PGA AND BGA PACKAGES
AT 400 MHZ, 366 MHZ, 333 MHZ, 300PE MHZ, AND 266PE MHZ**

Table 5.5 Voltage and No-Connect Ball/Pin Locations

Signal Name	Ball Numbers
NC	A10, A12, A13, A24, B9, B10, B11, B12, B13, B14, C2, C3, C10, C11, C12, C13, C14, D12, D13, E6, E11, E12, E13, E24, F6, F7, F8, F9, F10, F11, F12, F13, F14, F15, F16, F17, F18, F19, F23, G6, G7, G8, G17, G18, G19, G23, H6, H7, H8, H17, H18, H19, J6, J7, J8, J17, J18, J19, K6, K7, K8, K17, K18, K19, L6, L7, L8, L17, L18, L19, M6, M7, M8, M17, M18, M19, N6, N7, N8, N17, N18, N19, P6, P7, P8, P17, P18, P19, R6, R7, R8, R17, R18, R19, T6, T7, T8, T17, T18, T19, U4, U6, U7, U8, U17, U18, U19, V3, V6, V7, V8, V17, V18, V19, V20, W6, W7, W8, W17, W18, W19, W20, Y6, Y7, Y8, Y17, Y18, Y19, Y20, Y21, AA5, AA6, AA7, AA8, AA9, AA10, AA11, AA12, AA13, AA14, AA15, AA16, AA17, AA18, AA19, AA20, AA21, AA22, AA23, AB3, AB5, AB6, AB7, AB8, AB9, AB10, AB11, AB12, AB13, AB14, AB15, AB16, AB17, AB18, AB19, AB20, AB21, AB22, AB23, AB24, AC3, AC6, AC7, AC8, AC9, AC10, AC11, AC12, AC13, AC14, AC15, AC16, AC17, AC18, AC19, AC20, AC22, AD5, AD6, AD7, AD8, AD9, AD10, AD11, AD12, AD13, AD14, AD15, AD16, AD17, AD18, AD19, AD20, AD21, AD22, AD23, AD24, AE8, AE9, AE10, AE11, AE12, AE13, AE14, AE15, AE16, AE17, AE18, AE19, AE20, AE21, AE22, AE23, AE24, AF1, AF8, AF9, AF10, AF11, AF12, AF13, AF14, AF15, AF16, AF17, AF18, AF19, AF20, AF21, AF22, AF23, AF24
VCC	G10, G12, G14, G16, H9, H11, H13, H15, J10, J12, J14, J16, K9, K11, K13, K15, L10, L12, L14, L16, M9, M11, M13, M15, N10, N12, N14, N16, P9, P11, P13, P15, R10, R12, R14, R16, T9, T11, T13, T15, U10, U12, U14, U16, V9, V11, V13, V15, W10, W12, W14, W16, Y9, Y11, Y13, Y15, AD3
VCCP	F24, U2, V5, W5, Y22, Y23, AB4, AD2
VSS	A2, A3, A5, A8, A9, A11, A14, A16, A17, A20, A23, B1, B23, B24, C1, D2, D5, D8, D11, D14, D17, D20, D23, E5, E20, G4, G9, G11, G13, G15, G21, H10, H12, H14, H16, J9, J11, J13, J15, K1, K3, K4, K10, K12, K14, K16, K21, K22, K24, L9, L11, L13, L15, M10, M12, M14, M16, N1, N4, N9, N11, N13, N15, N21, N24, P1, P10, P12, P14, P16, P24, R9, R11, R13, R15, T1, T4, T10, T12, T14, T16, T21, T24, U9, U11, U13, U15, V10, V12, V14, V16, W3, W4, W9, W11, W13, W15, W21, W22, Y1, Y10, Y12, Y14, Y16, Y24, AC4, AC23, AC24, AD1, AE1, AE2, AE3, AE4, AE5, AE6, AE7, AF2, AF4, AF7



6. THERMAL SPECIFICATIONS

In order to achieve proper cooling of the processor, a thermal solution (e.g., heat spreader, heat pipe, or other heat transfer system) must make firm contact to the exposed processor die. The processor die must be clean before the thermal solution is attached or the processor may be damaged.

During all operating environments, the processor case temperature, T_{CASE} , must be within the specified range of 0°C to 100°C. An A/D converter attached to the thermal diode can be used to measure the processor core temperature to ensure compliance with this specification. The designer is responsible for insuring that the thermal diode and A/D converter accurately track the processor temperature. The designer should verify this by correlating “sensor” output temperature with a thermocouple placed directly on the die surface. Refer to Section 6.2 for more details.

Symbol	Parameter	Min	Typ ¹	Max	Unit	Notes
TDP	Thermal Design Power @ 400 MHz		—	9.80	W	at 100 °C ^{2,3}
	@ 366 MHz		—	13.10	W	
	@ 333 MHz		—	11.80	W	
	@ 300PE MHz		—	11.10	W	
	@ 266PE MHz		—	9.80	W	
	@ 266PE MHz Low Voltage		—	7.90	W	
P _{SGNT}	Stop Grant and Auto Halt power			1.25	W	at 50°C ³
P _{QS}	Quick Start and Sleep power			500	mW	at 50°C ³
P _{D_{SLP}}	Deep Sleep power			150	mW	at 50°C ³
T _{CASE}	Case Temperature	0		100	°C	

NOTES:

1. TDP_{Typ} is a recommendation based on the power dissipation of the processor while executing publicly available software under normal operating conditions at nominal voltages. Contact your Intel Field Sales Representative for further information.
2. TDP_{Max} is a specification of the total power dissipation of the processor while executing a worst-case instruction mix under normal operating conditions at nominal voltages. It includes the power dissipated by all of the components within the processor. Specified by design/characterization.
3. Not 100% tested or guaranteed. The power specifications are composed of the current of the processor on the various voltage planes. These currents are measured and specified at high temperature in Table 3.10. These 50°C power specifications are determined by characterization of the processor currents at higher temperatures.



6.1 Thermal Diode

The Mobile Pentium II processor has an on-die diode that can be used to monitor the die temperature. A thermal sensor located on the

system electronics may use the diode to monitor the die temperature of the processor for thermal management purposes. Table 6.2 and Table 6.3 provide the diode interface and specifications.

Table 6.2 Thermal Diode Interface

Signal Name	Ball/Pin Number	Signal Description
THERMDA	T3	Thermal diode anode
THERMDC	U3	Thermal diode cathode

Table 6.3. Thermal Diode Specifications

Symbol	Parameter	Min	Typ	Max	Unit	Notes
I _{FW}	Forward Bias Current	5		500	μA	Note 1
n	Diode Ideality Factor	1.0057	1.0080	1.0125		Notes 2, 4, 5
n	Diode Ideality Factor	1.0000	1.0065	1.0173		Notes 3, 4, 5

NOTES:

- Intel does not support or recommend operation of the thermal diode under reverse bias. Intel does not support or recommend operation of the thermal diode when the processor power supplies are not within their specified tolerance range.
- For the 400 MHz processor. Characterized at 100°C.
- For the 366 MHz processor and below. Characterized at 35°C.
- Not 100% tested. Specified by design/characterization.
- The ideality factor, n, represents the deviation from ideal diode behavior as exemplified by the diode I/V equation:

$$I = I_o \cdot \left(\frac{qV_D}{nkT} - 1 \right)$$

6.2 Case Temperature

To verify that the proper T_{CASE} (case temperature) is maintained for the processor, it should be measured at the center of the die on the package top surface. To minimize any measurement errors, the following techniques are recommended:

- Use 36 gauge or finer diameter K, T or J type thermocouples. Intel's laboratory testing was done using a thermocouple made by Omega (part number: 5TC-TTK-36-36).
- Attach the thermocouple bead or junction to the center of the die on the top package surface using highly thermally conductive cements. Intel's laboratory testing was done using Omega Bond (part number: OB100). Thermal grease provides equivalent temperature measurement results when used correctly but is not as mechanically resilient as cement.
- The thermocouple should be attached at a 90° angle as shown in Figure 6.1. A horizontal thermocouple mount is acceptable.

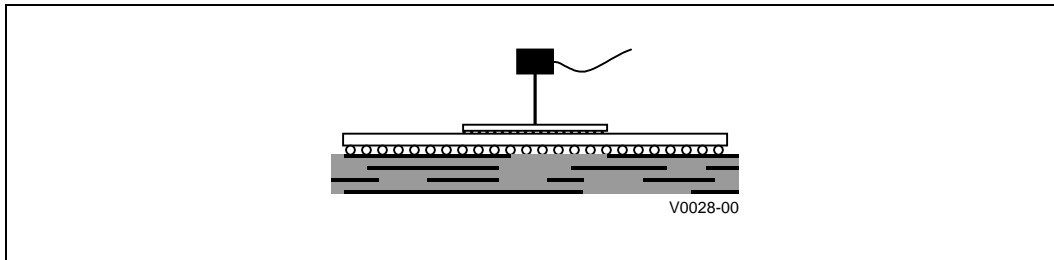

Figure 6.1 Technique for Measuring Case Temperature



7. PROCESSOR INITIALIZATION AND CONFIGURATION

7.1 Description

The Mobile Pentium® II processor has some configuration options that are determined by hardware and some that are determined by software. The processor samples its hardware configuration at reset, on the active-to-inactive transition of RESET#. Most of the configuration options for the Mobile Pentium II processor are identical to those of the Pentium II processor. The *Pentium® II Processor Developer's Manual* (order number 243502) describes these configuration options. New configuration options for the Mobile Pentium II processor are described in the remainder of this section.

7.1.1 Quick Start Enable

The processor normally enters the Stop Grant state when the STPCLK# signal is asserted, but it will enter the Quick Start state instead if A15# is sampled active on the RESET# signal's active-to-inactive transition. The Quick Start state supports snoops from the bus priority device like the Stop Grant state, but it does not support symmetric master snoops, nor is the latching of interrupts supported. A '1' in bit position 5 of the Power-On Configuration register indicates that the Quick Start state has been enabled.

7.1.2 System Bus Frequency

The current generation Mobile Pentium II processor will only function with a system bus frequency of 66 MHz, but future generations may operate at 100 MHz. Bit position 19 of the Power-On Configuration register indicates at which speed a processor will run. A '0' in bit 19 indicates a 66-MHz bus frequency and a '1' indicates a 100-MHz bus frequency.

7.1.3 APIC Disable

The APIC has been removed as a feature of the Mobile Pentium II processor. The PICCLK and PICD[1:0] signals must be tied to V_{SS} with a 1K Ω resistor to disable the APIC. Driving PICD0 low at reset has the effect of clearing the APIC Global Enable bit in the APIC Base MSR. This bit is normally set when the processor is reset, but when it is cleared the APIC is completely disabled until the next reset.

7.2 Clock Frequencies and Ratios

The Mobile Pentium II processor uses a clock design in which the bus clock is multiplied by a ratio to produce the processor's internal (or "core") clock. The Bus Fraction Locking scheme implemented in the processor permanently sets the clock ratio multiplier to the corresponding processor marked frequency. Section 3.3 describes how this is done. The bus ratio programmed into the processor is visible in bit positions 22 to 25 of the Power-On Configuration register. Table 3.4 shows the 4-bit codes in the Power-On Configuration register and their corresponding bus ratios.



8. PROCESSOR INTERFACE

8.1 Alphabetical Signal Reference

Except for BCLK, the 1.5V Tolerant signals are for the 400 MHz; the 2.5V tolerant signals are for the 366 MHz and below.

A[35:3]# (I/O - Low Power GTL+)

The A[35:3]# (Address) signals define a 2^{36} -byte physical memory address space. When ADS# is active, these signals transmit the address of a transaction; when ADS# is inactive, these signals transmit transaction information. These signals must be connected to the appropriate balls/pins of both agents on the system bus. The A[35:24]# signals are protected with the AP1# parity signal, and the A[23:3]# signals are protected with the AP0# parity signal.

On the active-to-inactive transition of RESET#, each processor bus agent samples A[35:3]# signals to determine its power-on configuration. See Section 7 of this document and the *Pentium® II Processor Developer's Manual* for details.

A20M# (I - 1.5V/2.5V tolerant)

If the A20M# (Address-20 Mask) input signal is asserted, the processor masks physical address bit 20 (A20#) before looking up a line in any internal cache and before driving a read/write transaction on the bus. Asserting A20M# emulates the 8086 processor's address wrap-around at the 1-Mbyte boundary. Assertion of A20M# is only supported in real mode.

ADS# (I/O - Low Power GTL+)

The ADS# (Address Strobe) signal is asserted to indicate the validity of a transaction address on the A[35:3]# signals. Both bus agents observe the ADS# activation to begin parity checking, protocol checking, address decode, internal snoop or deferred reply ID match operations associated with the new transaction. This signal must be connected

to the appropriate balls/pins on both agents on the system bus.

AERR# (I/O - Low Power GTL+)

The AERR# (Address Parity Error) signal is observed and driven by both system bus agents, and if used, must be connected to the appropriate balls of both agents on the system bus. AERR# observation is optionally enabled during power-on configuration; if enabled, a valid assertion of AERR# aborts the current transaction.

If AERR# observation is disabled during power-on configuration, a central agent may handle an assertion of AERR# as appropriate to the error handling architecture of the system.

The AERR# processor bus pin is removed as a processor feature for mobile Pentium® II processor at 400 MHz. The pin must still be terminated to Vcc through a 120Ω pull-up resistor. But the processor must not be configured to drive or observe the pin.

AP[1:0]# (I/O - Low Power GTL+)

The AP[1:0]# (Address Parity) signals are driven by the request initiator along with ADS#, A[35:3]#, REQ[4:0]# and RP#. AP1# covers A[35:24]#. AP0# covers A[23:3]#. A correct parity signal is high if an even number of covered signals are low and low if an odd number of covered signals are low. This allows parity to be high when all the covered signals are high. AP[1:0]# should be connected to the appropriate balls/pins on both agents on the system bus.

BCLK (I - 2.5V tolerant)

The BCLK (Bus Clock) signal determines the system bus frequency. Both system bus agents must receive this signal to drive their outputs and latch their inputs on the BCLK rising edge. All external timing parameters are specified with respect to the BCLK signal.



BERR# (I/O - Low Power GTL+)

The BERR# (Bus Error) signal is asserted to indicate an unrecoverable error without a bus protocol violation. It may be driven by either system bus agent, and must be connected to the appropriate balls/pins of both agents, if used. However, the Mobile Pentium® II processor does not observe assertions of the BERR# signal.

BERR# assertion conditions are defined by the system configuration. Configuration options enable the BERR# driver as follows:

- Enabled or disabled
- Asserted optionally for internal errors along with IERR#
- Asserted optionally by the request initiator of a bus transaction after it observes an error
- Asserted by any bus agent when it observes an error in a bus transaction

BINIT# (I/O - Low Power GTL+)

The BINIT# (Bus Initialization) signal may be observed and driven by both system bus agents, and must be connected to the appropriate balls/pins of both agents, if used. If the BINIT# driver is enabled during the power-on configuration, BINIT# is asserted to signal any bus condition that prevents reliable future information.

If BINIT# is enabled during power-on configuration, and BINIT# is sampled asserted, all bus state machines are reset and any data which was in transit is lost. All agents reset their rotating ID for bus arbitration to the state after reset, and internal count information is lost. The L1 and L2 caches are not affected.

If BINIT# is disabled during power-on configuration, a central agent may handle an assertion of BINIT# as appropriate to the Machine Check Architecture (MCA) of the system.

BNR# (I/O - Low Power GTL+)

The BNR# (Block Next Request) signal is used to assert a bus stall by any bus agent that is unable to

accept new bus transactions. During a bus stall, the current bus owner cannot issue any new transactions.

Since multiple agents may need to request a bus stall simultaneously, BNR# is a wired-OR signal which must be connected to the appropriate balls/pins of both agents on the system bus. In order to avoid wire-OR glitches associated with simultaneous edge transitions driven by multiple drivers, BNR# is activated on specific clock edges and sampled on specific clock edges.

BP[3:2]# (I/O - Low Power GTL+)

The BP[3:2]# (Breakpoint) signals are the System Support group Breakpoint signals. They are outputs from the processor that indicate the status of breakpoints.

BPM[1:0]# (I/O - Low Power GTL+)

The BPM[1:0]# (Breakpoint Monitor) signals are breakpoint and performance monitor signals. They are outputs from the processor that indicate the status of breakpoints and programmable counters used for monitoring processor performance.

BPRI# (I - Low Power GTL+)

The BPRI# (Bus Priority Request) signal is used to arbitrate for ownership of the system bus. It must be connected to the appropriate balls/pins on both agents on the system bus. Observing BPRI# active (as asserted by the priority agent) causes the processor to stop issuing new requests, unless such requests are part of an ongoing locked operation. The priority agent keeps BPRI# asserted until all of its requests are completed, and then releases the bus by deasserting BPRI#.

BREQ0# (I/O - Low Power GTL+)

The BREQ0# (Bus Request) signal is a processor Arbitration Bus signal. The processor indicates that it wants ownership of the system bus by asserting the BREQ0# signal.



During power-up configuration, the central agent must assert the BREQ0# bus signal. The processor samples BREQ0# on the active-to-inactive transition of RESET#.

BSEL (I - 1.5V/2.5V tolerant)

The BSEL (System Bus Speed Select) signal is used to configure the processor for the system bus frequency. A '1' on this signal configures the processor for 100 MHz operation and a '0' configures it for 66 MHz operation. This signal must be connected to V_{SS}.

D[63:0]# (I/O - Low Power GTL+)

The D[63:0]# (Data) signals are the data signals. These signals provide a 64-bit data path between both system bus agents, and must be connected to the appropriate balls/pins on both agents. The data driver asserts DRDY# to indicate a valid data transfer.

DBSY# (I/O - Low Power GTL+)

The DBSY# (Data Bus Busy) signal is asserted by the agent responsible for driving data on the system bus to indicate that the data bus is in use. The data bus is released after DBSY# is deasserted. This signal must be connected to the appropriate balls/pins on both agents on the system bus.

DEFER# (I - Low Power GTL+)

The DEFER# (Defer) signal is asserted by an agent to indicate that the transaction cannot be guaranteed in-order completion. Assertion of DEFER# is normally the responsibility of the addressed memory agent or I/O agent. This signal must be connected to the appropriate balls/pins on both agents on the system bus.

DEP[7:0]# (I/O - Low Power GTL+)

The DEP[7:0]# (Data Bus ECC Protection) signals provide optional ECC protection for the data bus. They are driven by the agent responsible for driving D[63:0]#, and must be connected to the appropriate

balls/pins on both agents on the system bus if they are used. During power-on configuration, DEP[7:0]# signals can be enabled for ECC checking or disabled for no checking.

DRDY# (I/O - Low Power GTL+)

The DRDY# (Data Ready) signal is asserted by the data driver on each data transfer, indicating valid data on the data bus. In a multi-cycle data transfer, DRDY# can be deasserted to insert idle clocks. This signal must be connected to the appropriate balls/pins on both agents on the system bus.

EDGCTRLN (analog)

This signal is used to configure the edge rate of the Low Power GTL+ output buffers. Connect the EDGCTRLN (Edge Rate Control N-FET) signal to V_{CC} with a 51Ω, 1% resistor.

FERR# (O - 1.5V/2.5V tolerant open-drain)

The FERR# (Floating-point Error) signal is asserted when the processor detects an unmasked floating-point error. FERR# is similar to the ERROR# signal on the Intel387 coprocessor, and is included for compatibility with systems using DOS-type floating-point error reporting.

FLUSH# (I - 1.5V/2.5V tolerant)

When the FLUSH# (Flush) input signal is asserted, the processor writes back all internal cache lines in the Modified state and invalidates all internal cache lines. At the completion of a flush operation, the processor issues a Flush Acknowledge transaction. The processor stops caching any new data while the FLUSH# signal remains asserted.

On the active-to-inactive transition of RESET#, each processor bus agent samples FLUSH# to determine its power-on configuration.



**HIT# (I/O - Low Power GTL+), HITM#
(I/O - Low Power GTL+)**

The HIT# (Snoop Hit) and HITM# (Hit Modified) signals convey transaction snoop operation results, and must be connected to the appropriate balls/pins on both agents on the system bus. Either bus agent can assert both HIT# and HITM# together to indicate that it requires a snoop stall, which can be continued by reasserting HIT# and HITM# together.

IERR# (O - 1.5V/2.5V tolerant open-drain)

The IERR# (Internal Error) signal is asserted by the processor as the result of an internal error. Assertion of IERR# is usually accompanied by a SHUTDOWN transaction on the system bus. This transaction may optionally be converted to an external error signal (e.g., NMI) by system logic. The processor will keep IERR# asserted until it is handled in software or with the assertion of RESET#, BINIT or INIT#.

IGNNE# (I - 1.5V/2.5V tolerant)

The IGNNE# (Ignore Numeric Error) signal is asserted to force the processor to ignore a numeric error and continue to execute non-control floating-point instructions. If IGNNE# is deasserted, the processor freezes on a non-control floating-point instruction if a previous instruction caused an error. IGNNE# has no effect when the NE bit in control register 0 (CR0) is set.

During active RESET#, the processor begins sampling the A20M#, IGNNE#, INTR and NMI values to determine the ratio of core-clock frequency to bus-clock frequency (see Table 3.4). On the active-to-inactive transition of RESET#, the processor latches these signals and freezes the frequency ratio internally. System logic must then release these signals for normal operation.

INIT# (I - 1.5V/2.5V tolerant)

The INIT# (Initialization) signal is asserted to reset integer registers inside the processor without affecting the internal (L1 or L2) caches or the

floating-point registers. The processor begins execution at the power-on reset vector configured during power-on configuration. The processor continues to handle snoop requests during INIT# assertion. INIT# is an asynchronous input.

If INIT# is sampled active on RESET#'s active-to-inactive transition, then the processor executes its built-in self test (BIST).

INTR (I - 1.5V/2.5V tolerant)

The INTR (Interrupt) signal indicates that an external interrupt has been generated. The interrupt is maskable using the IF bit in the EFLAGS register. If the IF bit is set, the processor vectors to the interrupt handler after completing the current instruction execution. Upon recognizing the interrupt request, the processor issues a single Interrupt Acknowledge (INTA) bus transaction. INTR must remain active until the INTA bus transaction to guarantee its recognition. INTR must be deasserted for a minimum of two clocks to guarantee its inactive recognition.

LOCK# (I/O - Low Power GTL+)

The LOCK# (Lock) signal indicates to the system that a sequence of transactions must occur atomically. This signal must be connected to the appropriate balls/pins on both agents on the system bus. For a locked sequence of transactions, LOCK# is asserted from the beginning of the first transaction through the end of the last transaction.

When the priority agent asserts BPRI# to arbitrate for bus ownership, it waits until it observes LOCK# deasserted. This enables the processor to retain bus ownership throughout the bus locked operation and guarantee the atomicity of lock.

NMI (I - 1.5V/2.5V tolerant)

The NMI (Non-Maskable Interrupt) indicates that an external interrupt has been generated. Asserting NMI causes an interrupt with an internally supplied vector value of 2. An external interrupt-acknowledge transaction is not generated. If NMI is asserted during the execution of an NMI service routine, it



remains pending and is recognized after the IRET is executed by the NMI service routine. At most, one assertion of NMI is held pending. NMI is rising-edge sensitive. Active and inactive pulse widths must be a minimum of two clocks.

PICCLK (I - 1.5V/2.5V tolerant)

The PICCLK (APIC Clock) signal is an input clock to the processor and system logic or I/O APIC that is required for operation of the processor, system logic and I/O APIC components on the APIC bus.

PICD[1:0] (I/O - 1.5V/2.5V tolerant open-drain)

The PICD[1:0] (APIC Data) signals are used for bidirectional serial message passing on the APIC bus. They must be connected to the appropriate balls/pins of all APIC bus agents, including the processor and the system logic or I/O APIC components. If the PICD0 signal is sampled low on the active-to-inactive transition of the RESET# signal, then the APIC is hardware disabled.

PRDY# (O - Low Power GTL+)

The PRDY# (Probe Ready) signal is a processor output used by debug tools to determine processor debug readiness.

PREQ# (I - 1.5V/2.5V tolerant)

The PREQ# (Probe Request) signal is used by debug tools to request debug operation of the processor.

PWRGOOD (I - 2.5V/2.5V tolerant)

PWRGOOD (Power Good) is a 1.5V tolerant input for the 400 MHz, and 2.5V tolerant for the 366 MHz and below. The processor requires this signal to be a clean indication that clocks and the power supplies (V_{CC} , V_{CCP} , etc.) are stable and within their specifications. Clean implies that the signal will remain low, (capable of sinking leakage current) and without glitches, from the time that the power supplies are turned on, until they come within specification. The signal will then transition monotonically to a high (1.5V or 2.5V) state. Figure 8.1 illustrates the relationship of PWRGOOD to other system signals. PWRGOOD can be driven inactive at any time, but clocks and power must again be stable before the rising edge of PWRGOOD. It must also meet the minimum pulse width specified in Table 3.16 (Section 3.5), and be followed by a 1 ms RESET# pulse.

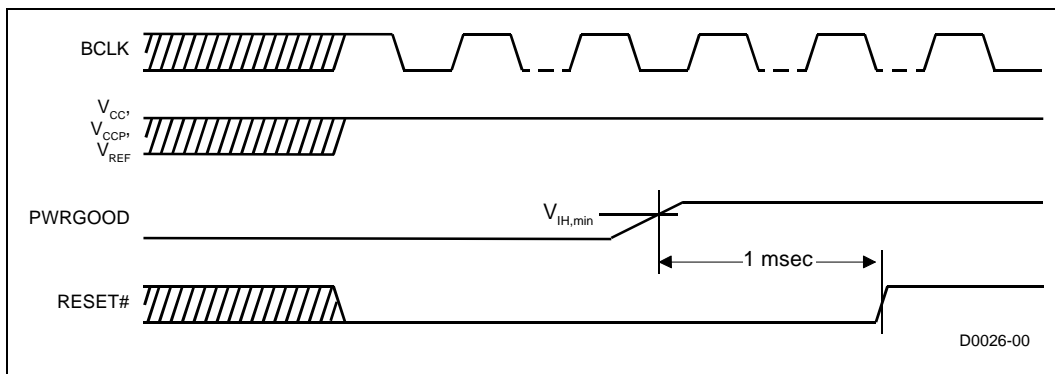

Figure 8.1 PWRGOOD Relationship at Power-On



**MOBILE PENTIUM® II PROCESSOR IN MICRO-PGA AND BGA PACKAGES
AT 400 MHZ, 366 MHZ, 333 MHZ, 300PE MHZ, AND 266PE MHZ**

The PWRGOOD signal, which must be supplied to the processor, is used to protect internal circuits against voltage sequencing issues. The PWRGOOD signal should be driven high throughout boundary scan operation.

REQ[4:0]# (I/O - Low Power GTL+)

The REQ[4:0]# (Request Command) signals must be connected to the appropriate balls/pins on both agents on the system bus. They are asserted by the current bus owner when it drives A[35:3]# to define the currently active transaction type.

RESET# (I - Low Power GTL+)

Asserting the RESET# signal resets the processor to a known state and invalidates the L1 and L2 caches without writing back Modified (M state) lines. For a power-on type reset, RESET# must stay active for at least 1 msec after V_{CC} and BCLK have reached their proper DC and AC specifications and after PWRGOOD has been asserted. When observing active RESET#, all bus agents will deassert their outputs within two clocks.

A number of bus signals are sampled at the active-to-inactive transition of RESET# for the power-on configuration. The configuration options are described in Section 7 and in the *Pentium® II Processor Developer's Manual*.

Unless its outputs are tri-stated during power-on configuration, after an active-to-inactive transition of RESET#, the processor optionally executes its built-in self-test (BIST) and begins program execution at reset-vector 000FFFF0H or FFFFFFF0H. RESET# must be connected to the appropriate balls/pins on both agents on the system bus.

RP# (I/O - Low Power GTL+)

The RP# (Request Parity) signal is driven by the request initiator, and provides parity protection on ADS# and REQ[4:0]#. RP# should be connected to the appropriate balls/pins on both agents on the system bus.

A correct parity signal is high if an even number of covered signals are low, and low if an odd number of covered signals are low. This definition allows parity to be high when all covered signals are high.

RS[2:0]# (I - Low Power GTL+)

The RS[2:0]# (Response Status) signals are driven by the response agent (the agent responsible for completion of the current transaction), and must be connected to the appropriate balls/pins on both agents on the system bus.

RSP# (I - Low Power GTL+)

The RSP# (Response Parity) signal is driven by the response agent (the agent responsible for completion of the current transaction) during assertion of RS[2:0]#. RSP# provides parity protection for RS[2:0]#. RSP# should be connected to the appropriate balls/pins on both agents on the system bus.

A correct parity signal is high if an even number of covered signals are low, and low if an odd number of covered signals are low. During Idle state of RS[2:0]# (RS[2:0]#=000), RSP# is also high since it is not driven by any agent guaranteeing correct parity.

SLP# (I - 1.5V/2.5V tolerant)

The SLP# (Sleep) signal, when asserted in the Stop Grant state, causes the processor to enter the Sleep state. During the Sleep state, the processor stops providing internal clock signals to all units, leaving only the Phase-Locked Loop (PLL) still running. The processor will not recognize snoop and interrupts in the Sleep state. The processor will only recognize changes in the SLP#, STPCLK# and RESET# signals while in the Sleep state. If SLP# is deasserted, the processor exits Sleep state and returns to the Stop Grant state in which it restarts its internal clock to the bus and APIC processor units.



SMI# (I - 1.5V/2.5V tolerant)

The SMI# (System Management Interrupt) is asserted asynchronously by system logic. On accepting a System Management Interrupt, the processor saves the current state and enters System Management Mode (SMM). An SMI Acknowledge transaction is issued, and the processor begins program execution from the SMM handler.

STPCLK# (I - 1.5V/2.5V tolerant)

The STPCLK# (Stop Clock) signal, when asserted, causes the processor to enter a low-power Stop Grant state. The processor issues a Stop Grant Acknowledge special transaction, and stops providing internal clock signals to all units except the bus and APIC units. The processor continues to snoop bus transactions and service interrupts while in the Stop Grant state. When STPCLK# is deasserted, the processor restarts its internal clock to all units and resumes execution. The assertion of STPCLK# has no effect on the bus clock.

TCK (I - 1.5V/2.5V tolerant)

The TCK (Test Clock) signal provides the clock input for the test bus (also known as the test access port).

TDI (I - 1.5V/2.5V tolerant)

The TDI (Test Data In) signal transfers serial test data to the processor. TDI provides the serial input needed for JTAG support.

TDO (O - 1.5V/2.5V tolerant open-drain)

The TDO (Test Data Out) signal transfers serial test data from the processor. TDO provides the serial output needed for JTAG support.

THERMDA, THERMDC (analog)

The THERMDA (Thermal Diode Anode) and THERMDC (Thermal Diode Cathode) signals connect to the anode and cathode of the on-die thermal diode.

TMS (I - 1.5V/2.5V tolerant)

The TMS (Test Mode Select) signal is a JTAG support signal used by debug tools.

TRDY# (I - Low Power GTL+)

The TRDY# (Target Ready) signal is asserted by the target to indicate that the target is ready to receive write or implicit writeback data transfer. TRDY# must be connected to the appropriate balls/pins on both agents on the system bus.

TRST# (I - 1.5V/2.5V tolerant)

The TRST# (Test Port Reset) signal resets the Test Access Port (TAP) logic. The Mobile Pentium® II processor does not self-reset during power-on; therefore, it is necessary to drive this signal low during power-on reset.

VTOL (O – 1.6V tolerant open-drain)

The VTOL (Voltage Tolerance) signal indicates whether the processor has 2.5V tolerant CMOS signals or 1.5V tolerant CMOS signals. This signal is a high impedance pin on the 2.5V tolerant Mobile Pentium® II processor at 366 MHz and below, and is shorted to VSS on the 1.5V tolerant Mobile Pentium® II processor at 400 MHz. It is safe to connect this signal to 1.6V with a pull-up resistor..

8.2 Signal Summaries

Table 8.1 through Table 8.4 list the attributes of the processor input, output, and I/O signals.



**MOBILE PENTIUM® II PROCESSOR IN MICRO-PGA AND BGA PACKAGES
AT 400 MHZ, 366 MHZ, 333 MHZ, 300PE MHZ, AND 266PE MHZ**

Table 8.1 Input Signals

Name	Active Level	Clock	Signal Group	Qualified
A20M#	Low	Asynch	CMOS	Always
BCLK	High	—	System Bus	Always
BPRI#	Low	BCLK	System Bus	Always
BSEL	High	Asynch	Implementation	Always
DEFER#	Low	BCLK	System Bus	Always
FLUSH#	Low	Asynch	CMOS	Always
IGNNE#	Low	Asynch	CMOS	Always
INIT#	Low	Asynch	System Bus	Always
INTR	High	Asynch	CMOS	APIC disabled mode
NMI	High	Asynch	CMOS	APIC disabled mode
PICCLK	High	—	APIC	Always
PREQ#	Low	Asynch	Implementation	Always
PWRGOOD	High	Asynch	Implementation	Always
RESET#	Low	BCLK	System Bus	Always
RS[2:0]#	Low	BCLK	System Bus	Always
RSP#	Low	BCLK	System Bus	Always
SLP#	Low	Asynch	Implementation	Stop Grant state
SMI#	Low	Asynch	CMOS	Always
STPCLK#	Low	Asynch	Implementation	Always
TCK	High	—	JTAG	
TDI		TCK	JTAG	
TMS		TCK	JTAG	
TRDY#	Low	BCLK	System Bus	Response phase
TRST#	Low	Asynch	JTAG	



Table 8.2 Output Signals

Name	Active Level	Clock	Signal Group
FERR#	Low	Asynch	Open-Drain
IERR#	Low	Asynch	Open-Drain
PRDY#	Low	BCLK	Implementation
TDO	High	TCK	JTAG
VTOL	High	Asynch	Implementation

Table 8.3 Input/Output Signals (Single Driver)

Name	Active Level	Clock	Signal Group	Qualified
A[35:3]#	Low	BCLK	System Bus	ADS#, ADS#+1
ADS#	Low	BCLK	System Bus	Always
AP[1:0]#	Low	BCLK	System Bus	ADS#, ADS#+1
BREQ0#	Low	BCLK	System Bus	Always
BP[3:2]#	Low	BCLK	System Bus	Always
BPM[1:0]#	Low	BCLK	System Bus	Always
D[63:0]#	Low	BCLK	System Bus	DRDY#
DBSY#	Low	BCLK	System Bus	Always
DEP[7:0]#	Low	BCLK	System Bus	DRDY#
DRDY#	Low	BCLK	System Bus	Always
LOCK#	Low	BCLK	System Bus	Always
REQ[4:0]#	Low	BCLK	System Bus	ADS#, ADS#+1
RP#	Low	BCLK	System Bus	ADS#, ADS#+1



MOBILE PENTIUM® II PROCESSOR IN MICRO-PGA AND BGA PACKAGES
AT 400 MHZ, 366 MHZ, 333 MHZ, 300PE MHZ, AND 266PE MHZ

Table 8.4 Input/Output Signals (Multiple Driver)				
Name	Active Level	Clock	Signal Group	Qualified
AERR#	Low	BCLK	System Bus	ADS#+3
BERR#	Low	BCLK	System Bus	Always
BINIT#	Low	BCLK	System Bus	Always
BNR#	Low	BCLK	System Bus	Always
HIT#	Low	BCLK	System Bus	Always
HITM#	Low	BCLK	System Bus	Always
PICD[1:0]	High	PICCLK	APIC	Always



UNITED STATES, Intel Corporation
2200 Mission College Blvd., P.O. Box 58119, Santa Clara, CA 95052-8119
Tel: +1 408 765-8080

JAPAN, Intel Japan K.K.
5-6 Tokodai, Tsukuba-shi, Ibaraki-ken 300-26
Tel: + 81-29847-8522

FRANCE, Intel Corporation S.A.R.L.
1, Quai de Grenelle, 75015 Paris
Tel: +33 1-45717171

UNITED KINGDOM, Intel Corporation (U.K.) Ltd.
Pipers Way, Swindon, Wiltshire, England SN3 1RJ
Tel: +44 1-793-641440

GERMANY, Intel GmbH
Dornacher Strasse 1
85622 Feldkirchen/ Muenchen
Tel: +49 89/99143-0

HONG KONG, Intel Semiconductor Ltd.
32/F Two Pacific Place, 88 Queensway, Central
Tel: +852 2844-4555

CANADA, Intel Semiconductor of Canada, Ltd.
190 Attwell Drive, Suite 500
Rexdale, Ontario M9W 6H8
Tel: +416 675-2438

BRAZIL, Intel Semicondutores do Brasil
Centro Empresarial Nações Unidas - Edifício Torre Oeste
Av. das Nações Unidas, 12.901 - 18o. andar - Brooklin Novo
04578.000 São Paulo - S.P. - Brasil
Tel: +55-11-5505-2296

X-ON Electronics

Largest Supplier of Electrical and Electronic Components

Click to view similar products for CPU - Central Processing Units category:

Click to view products by Intel manufacturer:

Other Similar products are found below :

[AT80612003090AAS LBWJ](#) [B4860NSE7QUMD](#) [NPIXP2855AB-S-LA88](#) [IVPX7225-RTM-1](#) [96MPI5-2.9-6M10T](#) [2SC4646D-AN](#)
[SMBV1061LT1G](#) [2SC4646E-AN](#) [2SJ268-DL-E](#) [CP80617003981AHS LBTQ](#) [MATXM-CORE-411-HTSNK](#) [TEC0193BPF](#) [TND516SS-TL-E](#)
[BGSF 1717MN26 E6327](#) [D8086-2](#) [LF80538GF0282M-S-L8VY](#) [CM8063401293902S R1A4](#) [CM8063501521302S R1B8](#)
[CM8066201919901 SR2L0](#) [CM8066201928505 SR2HT](#) [CPH5855-TL-E](#) [CM8063501293200S R1A0](#) [AV8063801129600S R10F](#) [EMS36-02-](#)
[2H-MDT](#) [EMM04-MDT](#) [NG80386DX33](#) [GG8067402569300S R2DJ](#) [NK80530MZ866256S-L7XH](#) [P1021NXE2HFB](#) [R0K5ML001SS00BR](#)
[LC87F2608A](#) [LC87FBK08A](#) [PRIXP425BC](#) [PRIXP423BB](#) [CM8066201921712S R2LF](#) [CM8064601467102S R152](#) [CM8063501375800S](#)
[R1AX](#) [CM8063501293506S R1A2](#) [CM8063401293802S R1A3](#) [CM8062107185405S R0KM](#) [LC87F0G08A](#) [CM8066002032201S R2R6](#) [PB-](#)
[8SMB](#) [FJ8066401836620S R2KT](#) [COMX-300-HSP](#) [RTM-ATCA-7360](#) [96MPI7-3.4-8M11T](#) [CM8066002023801S R2J1](#) [96MPP-2.3-3M10T](#)
[96MPI7-3.4-8M11T1](#)