



# 82545GM Gigabit Ethernet Controller

Networking Silicon

Datasheet

## Product Features

- PCI/PCI-X
  - PCI-X Revision 1.0a support for frequencies up to 133 MHz
  - Multi-function PCI device
  - PCI Revision 2.3 support for 32-bit wide or 64-bit wide interface at 33 MHz and 66 MHz
- MAC
  - IEEE 802.3x compliant flow control support with software controllable pause times and threshold values
  - Programmable host memory receive buffers (256 Bytes to 16 Kbytes) and cache line size (16 Bytes to 256 Bytes)
  - Wide, optimized internal data path architecture (128 bits)
  - 64 Kbyte configurable Transmit and Receive FIFO buffers
  - Optimized descriptor fetching and write-back mechanisms
- PHY
  - Integrated PHY for 10/100/1000 Mbps full and half duplex operation
  - IEEE 802.3ab Auto-Negotiation support
  - IEEE 802.3ab PHY compliance and compatibility
  - PHY ability to automatically detect polarity and cable lengths and MDI versus MDI-X cable at all speeds
- Host Offloading
  - Transmit and receive IP, TCP and UDP checksum off-loading capabilities
  - Transmit TCP segmentation
  - IEEE 802.1q VLAN support with VLAN tag insertion, stripping and packet filtering for up to 4096 VLAN tags
  - Advanced packet filtering
- Manageability
  - Manageability features on both ports: SMB port, ASF 1.0, ACPI, Wake on LAN, and PXE
  - Compliance with PCI Power Management 1.1 and ACPI 2.0 register set compliant
- Four activity and link indication outputs that directly drive LEDs
- Lead-free<sup>a</sup> 364-pin Ball Grid Array (BGA). Devices that are lead-free are marked with a circled “e1” and have the product code: PCxxxxxx.

- a. This device is lead-free. That is, lead has not been intentionally added, but lead may still exist as an impurity at <1000 ppm. The Material Declaration Data Sheet, which includes lead impurity levels and the concentration of other Restriction on Hazardous Substances (RoHS)-banned materials, is available at:

[ftp://download.intel.com/design/packtech/material\\_content\\_IC\\_Package.pdf#pagemode=bookmarks](ftp://download.intel.com/design/packtech/material_content_IC_Package.pdf#pagemode=bookmarks)

In addition, this device has been tested and conforms to the same parametric specifications as previous versions of the device. For more information regarding lead-free products from Intel Corporation, contact your Intel Field Sales representative.



# Revision History

---

Revision	Date	Description
1.0	Mar 2003	Initial release.
1.1	Nov 2003	Removed Confidential Status. Modified power specification tables in Section 4.0. Added a ball pad dimension drawing for the 82545GM device in Section 5.0.
1.2	Sept 2004	Corrected the nominal impedance values for the I/O cells from 50 kohms to a nominal impedance value of 120 kohms, with a minimum of 90 kohms and a maximum of 190 kohms.
1.5	June 2005	Added Specification Change and Specification Clarification information from the 82545GM Gigabit Ethernet Controller Specification Update. Added a more detailed AUX_PWR pin description. Added tristate and XOR non-JTAG test modes description.
2.0	Sept 2005	Added lead free information.
2.1	Feb 2007	Updated Table 3.
2.2	Aug 2009	Updated section 5.2, table 3.

Information in this document is provided in connection with Intel products. No license, express or implied, by estoppel or otherwise, to any intellectual property rights is granted by this document. Except as provided in Intel's Terms and Conditions of Sale for such products, Intel assumes no liability whatsoever, and Intel disclaims any express or implied warranty, relating to sale and/or use of Intel products including liability or warranties relating to fitness for a particular purpose, merchantability, or infringement of any patent, copyright or other intellectual property right. Intel products are not intended for use in medical, life saving, or life sustaining applications.

Intel may make changes to specifications and product descriptions at any time, without notice.

Designers must not rely on the absence or characteristics of any features or instructions marked "reserved" or "undefined." Intel reserves these for future definition and shall have no responsibility whatsoever for conflicts or incompatibilities arising from future changes to them.

The 82545GM may contain design defects or errors known as errata which may cause the product to deviate from published specifications. Current characterized errata are available on request.

Contact your local Intel sales office or your distributor to obtain the latest specifications and before placing your product order.

Copies of documents which have an ordering number and are referenced in this document, or other Intel literature may be obtained by calling 1-800-548-4725 or by visiting Intel's website at <http://www.intel.com>.

Intel® is a trademark or registered trademark of Intel Corporation or its subsidiaries in the United States and other countries.

Copyright © 2009 Intel Corporation.

\*Third-party brands and names are the property of their respective owners.



# Contents

---

1.0	Introduction.....	1
1.1	Document Scope.....	2
1.2	Reference Documents.....	2
1.3	Product Code .....	3
2.0	Additional 82545GM Features.....	5
2.1	PCI .....	5
2.2	MAC Specific.....	5
2.3	PHY Specific .....	5
2.4	Host Offloading.....	5
2.5	Manageability .....	6
2.6	Additional Device.....	6
2.7	Technology .....	7
3.0	Signal Descriptions.....	9
3.1	Signal Type Definitions.....	9
3.2	PCI Bus Interface .....	9
3.2.1	PCI Address, Data and Control Signals .....	10
3.2.2	Arbitration Signals .....	11
3.2.3	Interrupt Signal.....	11
3.2.4	System Signals.....	12
3.2.5	Error Reporting Signals .....	12
3.2.6	Power Management Signals .....	12
3.2.7	Impedance Compensation Signals.....	13
3.2.8	SMB Signals.....	13
3.3	EEPROM Interface Signals .....	13
3.4	Flash Interface Signals.....	14
3.5	Miscellaneous Signals.....	14
3.5.1	LED Signals.....	14
3.5.2	Software Definable Signals .....	14
3.6	PHY Signals .....	15
3.6.1	Crystal Signals .....	15
3.6.2	Analog Signals .....	15
3.7	Serializer / Deserializer (SERDES) Signals .....	16
3.8	JTAG Test Interface Signals .....	16
3.9	Power Supply Connections .....	16
3.9.1	Power Support Signals.....	16
3.9.2	Digital Supplies.....	17
3.9.3	Analog Supplies .....	17
3.9.4	Ground and No Connects.....	17
4.0	Test Port Functionality.....	19
4.1	XOR Testing.....	19
4.1.1	XOR Tree Control and Operation.....	19
4.1.2	Pins Tested .....	20
4.2	Tristate Mode .....	21
4.2.1	Tristate Mode Control and Operation .....	21



	4.2.2	Tristate Mode Using JTAG (TAP).....	21
5.0		Voltage, Temperature, and Timing Specifications .....	23
	5.1	Targeted Absolute Maximum Ratings .....	23
	5.2	Recommended Operating Conditions .....	23
	5.3	DC Specifications .....	24
	5.4	AC Characteristics .....	28
	5.5	Serial Interface Specifications .....	29
	5.6	Timing Specifications .....	30
	5.6.1	PCI/PCI-X Bus Interface .....	30
	5.6.2	Link Interface Timing .....	33
	5.6.3	Flash Interface .....	36
	5.6.4	EEPROM Interface.....	37
6.0		Package and Pinout Information .....	39
	6.1	Device Identification .....	39
	6.2	Lead-Free Device Identification .....	40
	6.3	Package Information .....	41
	6.4	Thermal Specifications .....	43
	6.5	Ball Mapping Diagram .....	44
	6.6	Pinout Information .....	44



## 1.0 Introduction

---

The Intel® 82545GM Gigabit Ethernet Controller is a single, compact component with an integrated Gigabit Ethernet Media Access Control (MAC) and physical layer (PHY) functions. The Intel® 82545GM enables Gigabit Ethernet implementations in a very small area and can be used for desktop and workstation PC network designs as well as backplane applications with critical space constraints.

The Intel® 82545GM integrates Intel's fourth generation gigabit MAC and PHY to provide a standard IEEE 802.3 Ethernet interface for 1000BASE-T, 100BASE-TX, and 10BASE-T applications (802.3, 802.3u, and 802.3ab). The controller is capable of transmitting and receiving data at rates of 1000 Mbps, 100 Mbps, or 10 Mbps. In addition, it provides a 64-bit wide direct Peripheral Component Interconnect (PCI) 2.3 and PCI-X 1.0a compliant interface capable of operating at frequencies up to 133 MHz.

The Intel® 82545GM on-board System Management Bus (SMB) port enables network manageability implementations required by information technology personnel for remote control and alerting through the LAN. Using the SMB, management packets can be routed to or from a management processor. The SMB port enables industry standards, such as Intelligent Platform Management Interface (IPMI) and Alert Standard Format (ASF), to be implemented using the 82545GM. In addition, on chip ASF 1.0 circuitry provides alerting and remote control capabilities with standardized interfaces.

The 82545GM Gigabit Ethernet Controller architecture is designed to deliver high performance and PCI/PCI-X bus efficiency. Wide internal data paths eliminate performance bottlenecks by efficiently handling large address and data words. Combining a parallel and pipe-lined logic architecture optimized for Gigabit Ethernet and independent transmit and receive queues, the 82545GM controller efficiently handles packets with minimum latency. The 82545GM controller includes advanced interrupt handling features to limit PCI bus traffic and a PCI interface that maximizes the use of bursts for efficient bus usage. The 82545GM is able to cache up to 64 packet descriptors in a single burst for efficient PCI bandwidth use. A large 64-Kbyte on-chip packet buffer maintains superior performance as available PCI bandwidth changes. By using hardware acceleration, the controller is able to offload tasks, such as checksum calculations and TCP segmentation, from the host processor.



The 82545GM is packaged in a 21 mm x 21 mm 364-ball grid array and footprint compatible with the Intel® 82544GC Gigabit Ethernet Controller.

**Figure 1. Gigabit Ethernet Controller Block Diagram**

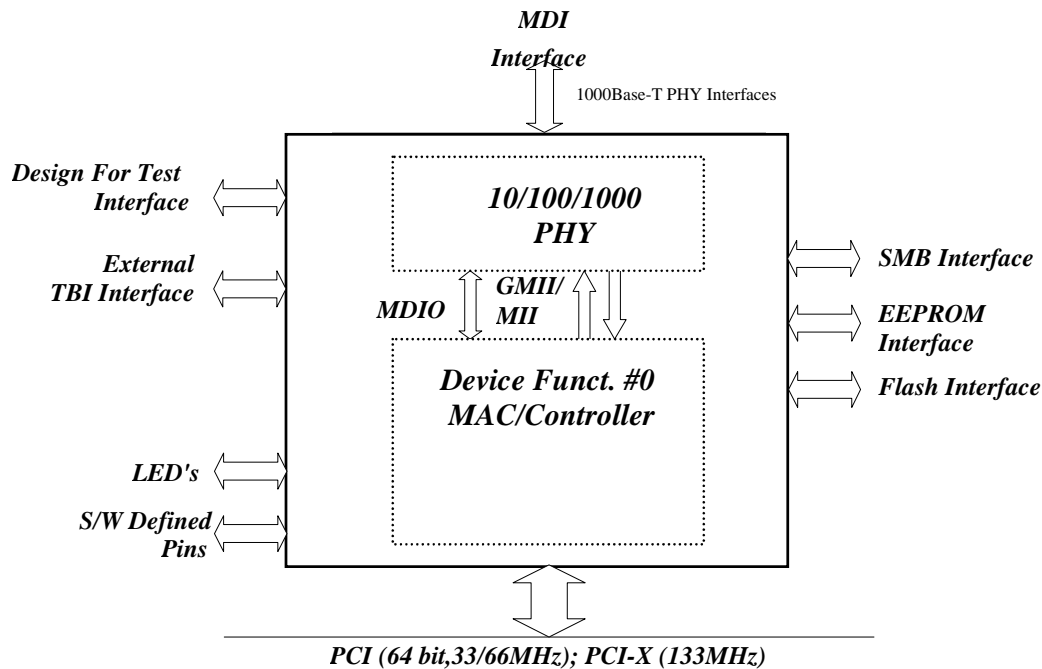

## 1.1 Document Scope

This document contains datasheet specifications for the 82545GM Gigabit Ethernet Controller, which includes signal descriptions, DC and AC parameters, packaging data, and pinout information.

## 1.2 Reference Documents

It is assumed that the designer is acquainted with high-speed design and board layout techniques. Document that may provide additional information are:

- PCI Local Bus Specification, Revision 2.3, PCI Special Interest Group.
- PCI-X Specification, Revision 1.0a, PCI Special Interest Group.
- PCI Bus Power Management Interface Specification, Rev. 1.1, PCI Special Interest Group.
- IEEE Standard 802.3, 1996 Edition, Institute of Electrical and Electronics Engineers (IEEE).
- IEEE Standard 802.3u, 1995 Edition, Institute of Electrical and Electronics Engineers (IEEE).
- IEEE Standard 802.3x, 1997 Edition, Institute of Electrical and Electronics Engineers (IEEE).
- IEEE Standard 802.3z, 1998 Edition, Institute of Electrical and Electronics Engineers (IEEE).



- IEEE Standard 802.3ab, 1999 Edition, Institute of Electrical and Electronics Engineers (IEEE).
- Intel<sup>®</sup> Ethernet Controllers Timing Device Selection Guide, AP-419. Intel Corporation.

### **1.3 Product Code**

The product ordering code for the 82545GM is: RC82545GM.

The product ordering code for the lead-free 82545GM is: PC82545GM.



*Note:* This page is intentionally left blank.





## 2.0 Additional 82545GM Features

---

### 2.1 PCI

Features	Benefits
Algorithms that optimally use advanced PCI, MWI, MRM, and MRL commands as well as PCI-X MRD, MRB, and MWB commands	<ul style="list-style-type: none"><li>• Efficient bus operations</li></ul>

### 2.2 MAC Specific

Features	Benefits
Low-latency transmit and receive queues	<ul style="list-style-type: none"><li>• Network packets handled without waiting or buffer overflow.</li></ul>
Mechanism available for reducing interrupts generated by transmit and receive operations	<ul style="list-style-type: none"><li>• Maximizes system performance and throughput</li></ul>
Support for transmission and reception of packets up to 16 Kbytes	<ul style="list-style-type: none"><li>• Enables jumbo frames</li></ul>

### 2.3 PHY Specific

Features	Benefits
State-of-the-art DSP architecture implements digital adaptive equalization, echo cancellation, and cross-talk cancellation	<ul style="list-style-type: none"><li>• Robust performance in noisy environments</li><li>• Tolerance of common electrical signal impairments</li></ul>

### 2.4 Host Offloading

Features	Benefits
Descriptor ring management hardware for transmit and receive	<ul style="list-style-type: none"><li>• Optimized fetching and write-back mechanisms for efficient system memory and PCI bandwidth usage</li></ul>
16 Kbyte jumbo frame support	<ul style="list-style-type: none"><li>• High throughput for large data transfers on networks supporting jumbo frames</li></ul>
Interrupt coalescing (multiple packets per interrupt)	<ul style="list-style-type: none"><li>• Increased throughput by reducing interrupts generated by transmit and receive operations</li></ul>

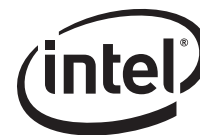

## 2.5 Manageability

Features	Benefits
On-board SMB port	<ul style="list-style-type: none"> <li>Enables IPMI and ASF implementations</li> <li>Allows packets routing to and from either LAN port and a server management processor</li> </ul>
Preboot eXecution Environment (PXE) Flash interface support (32-bit and 64-bit)	<ul style="list-style-type: none"> <li>Local Flash interface for PXE image</li> </ul>
SNMP and RMON statistic counters	<ul style="list-style-type: none"> <li>Easy system monitoring with industry standard consoles</li> </ul>
SDG 3.0, WfM 2.0, and PC2001 compliance	<ul style="list-style-type: none"> <li>Remote network management capabilities through DMI 2.0 and SNMP software</li> </ul>
Wake on LAN support	<ul style="list-style-type: none"> <li>Packet recognition and wake-up for NIC and LOM applications without software configuration</li> </ul>

## 2.6 Additional Device

Features	Benefits
Internal PLL for clock generation using a 25 MHz crystal as a clock reference	<ul style="list-style-type: none"> <li>Lower component count and system cost</li> </ul>
JTAG (IEEE 1149.1) Test Access Port built in silicon	<ul style="list-style-type: none"> <li>Simplified testing using boundary scan</li> </ul>
On-chip power control circuitry	<ul style="list-style-type: none"> <li>Reduced number of on-board power supply regulators</li> <li>Simplified power supply design</li> </ul>
Four software definable pins	<ul style="list-style-type: none"> <li>Additional flexibility for LEDs or other low speed I/O devices</li> </ul>
Supports little endian byte ordering for both 32 and 64 bit systems and big endian byte ordering for 64 bit systems	<ul style="list-style-type: none"> <li>Portable across application architectures</li> </ul>
Provides loopback capabilities	<ul style="list-style-type: none"> <li>Validates silicon integrity</li> </ul>
Single-pin LAN disable function	<ul style="list-style-type: none"> <li>Allows LAN port enabling and disabling through BIOS control (OS not required)</li> </ul>



## 2.7 Technology

Features	Benefits
364-pin Ball Grid Array (BGA) package	<ul style="list-style-type: none"><li>• 21 mm x 21 mm component making LOM designs easier</li></ul>
Footprint compatible with the 82544GC, 82545EM, and 82546EB controllers	<ul style="list-style-type: none"><li>• Single port or dual port implementation on the same board with minor option changes</li></ul>
Implemented in 0.15 $\mu$ CMOS process	<ul style="list-style-type: none"><li>• Offers lowest geometry to minimize power and size while maintaining Intel quality reliability standards</li></ul>
0 C to 70 C (maximum) operating temperature Heat sink or forced airflow not required 65 C to 140 C storage temperature range	<ul style="list-style-type: none"><li>• Simple thermal design</li></ul>
3.3 V (5 V tolerant) PCI signaling with power dissipation less than 2.0 W (maximum)	<ul style="list-style-type: none"><li>• Lower power requirements</li></ul>
Improved SERDES differential output	<ul style="list-style-type: none"><li>• Complies with PICMG 3.1 Specification</li></ul>



*Note:* This page intentionally left blank.



## 3.0 Signal Descriptions

---

**Note:** The targeted signal names are subject to change without notice. Verify with your local Intel sales office that you have the latest information before finalizing a design.

### 3.1 Signal Type Definitions

The signals of the 82545GM controller are electrically defined as follows:

Name	Definition
I	<b>Input.</b> Standard input only digital signal.
O	<b>Output.</b> Standard output only digital signal.
TS	<b>Tri-state.</b> Bi-directional three-state digital input/output signal.
STS	<b>Sustained Tri-state.</b> Sustained digital three-state signal driven by one agent at a time. An agent driving the STS pin low must actively drive it high for at least one clock before letting it float. The next agent of the signal cannot drive the pin earlier than one clock after it has been released by the previous agent.
OD	<b>Open Drain.</b> Wired-OR with other agents. The signaling agent asserts the OD signal, but the signal is returned to the inactive state by a weak pull-up resistor. The pull-up resistor may require two or three clock periods to fully restore the signal to the de-asserted state.
A	<b>Analog.</b> PHY analog data signal.
P	<b>Power.</b> Power connection, voltage reference, or other reference connection.
R	<b>Reserved.</b>

**Note:** The TTL inputs on the Ethernet controller are not 5V tolerant. If these inputs are connected to 5V, then damage to the Ethernet controller is likely to occur. TTL inputs include the JTAG interface pins, the FLASH interface pins, the EEPROM interface pins, the LED pins, the software definable pins, and the LAN\_PWR\_GOOD pin.

### 3.2 PCI Bus Interface

When the Reset signal (RST#) is asserted, the 82545GM will not drive any PCI output or bi-directional pins except the Power Management Event signal (PME#).



### 3.2.1 PCI Address, Data and Control Signals

Symbol	Type	Name and Function
AD[63:0]	TS	<p><b>Address and Data.</b> Address and data signals are multiplexed on the same PCI pins. A bus transaction includes an address phase followed by one or more data phases. The address phase is the clock cycle when the Frame signal (FRAME#) is asserted low. During the address phase AD[63:0] contain a physical address (64 bits). For I/O, this is a byte address, and for configuration and memory, a DWORD address. The 82545GM device uses little endian byte ordering.</p> <p>During data phases, AD[7:0] contain the least significant byte (LSB) and AD[63:56] contain the most significant byte (MSB).</p> <p>The 82545GM controller may optionally be connected to a 32-bit PCI bus. On the 32-bit bus, AD[63:32] and other signals corresponding to the high order byte lanes do not participate in the bus cycle.</p>
CBE[7:0]#	TS	<p><b>Bus Command and Byte Enables.</b> Bus command and byte enable signals are multiplexed on the same PCI pins. During the address phase of a transaction, CBE[7:0]# define the bus command. In the data phase, CBE[7:0]# are used as byte enables. The byte enables are valid for the entire data phase and determine which byte lanes contain meaningful data.</p> <p>CBE0# applies to byte 0 (LSB) and CBE7# applies to byte 7 (MSB).</p>
PAR	TS	<p><b>Parity.</b> The Parity signal is issued to implement even parity across AD[31:0] and CBE[3:0]#. PAR is stable and valid one clock after the address phase. During data phases, PAR is stable and valid one clock after either IRDY# is asserted on a write transaction or TRDY# is asserted after a read transaction. Once PAR is valid, it remains valid until one clock after the completion of the current data phase.</p> <p>When the 82545GM controller is a bus master, it drives PAR for address and write data phases, and as a slave device, drives PAR for read data phases.</p>
PAR64	TS	<p><b>Parity 64.</b> The Parity 64 signal is issued to implement even parity across AD[63:32] and CBE[7:4]#. PAR64 is stable and valid one clock after the address phase. During data phases, PAR64 is stable and valid one clock after either IRDY# is asserted on a write transaction or TRDY# is asserted after a read transaction. Once PAR64 is valid, it remains valid until one clock after the completion of the current data phase.</p> <p>When the 82545GM controller is a bus master, it drives PAR64 for address and write data phases, and as a slave device, drives PAR64 for read data phases.</p>
FRAME#	STS	<p><b>Cycle Frame.</b> The Frame signal is driven by the 82545GM device to indicate the beginning and length of an access and indicate the beginning of a bus transaction. While FRAME# is asserted, data transfers continue. FRAME# is de-asserted when the transaction is in the final data phase.</p>
IRDY#	STS	<p><b>Initiator Ready.</b> Initiator Ready indicates the ability of the 82545GM controller (as bus master device) to complete the current data phase of the transaction. IRDY# is used in conjunction with the Target Ready signal (TRDY#). The data phase is completed on any clock when both IRDY# and TRDY# are asserted.</p> <p>During the write cycle, IRDY# indicates that valid data is present on AD[63:0]. For a read cycle, it indicates the master is ready to accept data. Wait cycles are inserted until both IRDY# and TRDY# are asserted together. The 82545GM controller drives IRDY# when acting as a master and samples it when acting as a slave.</p>
TRDY#	STS	<p><b>Target Ready.</b> The Target Ready signal indicates the ability of the 82545GM controller (as a selected device) to complete the current data phase of the transaction. TRDY# is used in conjunction with the Initiator Ready signal (IRDY#). A data phase is completed on any clock when both TRDY# and IRDY# are sampled asserted.</p> <p>During a read cycle, TRDY# indicates that valid data is present on AD[63:0]. For a write cycle, it indicates the target is ready to accept data. Wait cycles are inserted until both IRDY# and TRDY# are asserted together. The 82545GM device drives TRDY# when acting as a slave and samples it when acting as a master.</p>



Symbol	Type	Name and Function
STOP#	STS	<b>Stop.</b> The Stop signal indicates the current target is requesting the master to stop the current transaction. As a slave, the 82545GM controller drives STOP# to request the bus master to stop the transaction. As a master, the 82545GM controller receives STOP# from the slave to stop the current transaction.
IDSEL#	I	<b>Initialization Device Select.</b> The Initialization Device Select signal is used by the 82545GM as a chip select signal during configuration read and write transactions.
DEVSEL#	STS	<b>Device Select.</b> When the Device Select signal is actively driven by the 82545GM, it signals notifies the bus master that it has decoded its address as the target of the current access. As an input, DEVSEL# indicates whether any device on the bus has been selected.
VIO	P	<b>VIO.</b> The VIO signal is a voltage reference for the PCI interface (3.3 V or 5 V PCI signaling environment). It is used as the clamping voltage. Note: An external resistor is required between the voltage reference and the VIO pin. The target resistor value is 100 K $\Omega$

### 3.2.2 Arbitration Signals

Symbol	Type	Name and Function
REQ64#	TS	<b>Request Transfer.</b> The Request Transfer signal is generated by the current initiator indicating its desire to perform a 64-bit transfer. REQ64# has the same timing as the Frame signal.
ACK64#	TS	<b>Acknowledge Transfer.</b> The Acknowledge Transfer signal is generated by the currently addressed target in response to the REQ64# assertion by the initiator. ACK64# has the same timing as the Device Select signal.
REQ#	TS	<b>Request Bus.</b> The Request Bus signal is used to request control of the bus from the arbiter. This signal is point-to-point.
GNT#	I	<b>Grant Bus.</b> The Grant Bus signal notifies the 82545GM that bus access has been granted. This is a point-to-point signal.
LOCK#	I	<b>Lock Bus.</b> The Lock Bus signal is asserted by an initiator to require sole access to a target memory device during two or more separate transfers. The 82545GM device does not implement bus locking.

### 3.2.3 Interrupt Signal

Symbol	Type	Name and Function
INTA#	TS	<b>Interrupt A.</b> Interrupt A is used to request an interrupt of the 82545GM. It is an active low, level-triggered interrupt signal.



### 3.2.4 System Signals

Symbol	Type	Name and Function
CLK	I	<b>PCI Clock.</b> The PCI Clock signal provides timing for all transactions on the PCI bus and is an input to the 82545GM device. All other PCI signals, except the Interrupt A (INTA#) and PCI Reset signal (RST#), are sampled on the rising edge of CLK. All other timing parameters are defined with respect to this edge.
M66EN	I	<b>66 MHz Enable.</b> The 66 MHz Enable signal is used to indicate whether or not the system bus is capable of supporting an operating frequency of 66 MHz.
RST#	I	<b>PCI Reset.</b> When the PCI Reset signal is asserted, all PCI output signals, except the Power Management Event signal (PME#), are floated and all input signals are ignored. The PME# context is preserved, depending on power management settings. Most of the internal state of the 82545GM is reset on the de-assertion (rising edge) of RST#.
LAN_PWR_GOOD	I	<b>Power Good (Power-on Reset).</b> The Power Good signal is used to indicate that stable power is available for the 82545GM. When the signal is low, the 82545GM holds itself in reset state and floats all PCI signals.

### 3.2.5 Error Reporting Signals

Symbol	Type	Name and Function
SERR#	OD	<b>System Error.</b> The System Error signal is used by the 82545GM controller to report address parity errors. SERR# is open drain and is actively driven for a single PCI clock when reporting the error.
PERR#	STS	<b>Parity Error.</b> The Parity Error signal is used by the 82545GM controller to report data parity errors during all PCI transactions except by a Special Cycle. PERR# is sustained tri-state and must be driven active by the 82545GM controller two data clocks after a data parity error is detected. The minimum duration of PERR# is one clock for each data phase a data parity error is present.

### 3.2.6 Power Management Signals

Symbol	Type	Name and Function
PME#	OD	<b>Power Management Event.</b> The 82545GM device drives this signal low when it receives a wake-up event and either the PME Enable bit in the Power Management Control/Status Register or the Advanced Power Management Enable (APME) bit of the Wake-up Control Register (WUC) is 1b.
AUX_PWR	I	<b>Auxiliary Power.</b> If the Auxiliary Power signal is high, then auxiliary power is available and the 82545GM device should support the D3cold power state. Note that AUX_PWR is not a supply input, but is an indication of whether AUX_PWR is available to the 82545GM and/or subsystem. Setting AUX_PWR to 1b enables advertising D3cold Wake Up support and changes the reset function of PME_En and PME_Status. AUX_PWR is level sensitive, and any changes are immediately reflected in the D3cold Wake Up advertisements and the PME_En and PME_Status behavior on PCI reset.





### 3.2.7 Impedance Compensation Signals

Symbol	Type	Name and Function
ZN_COMP	I/O	<b>N Device Impedance Compensation.</b> This signal should be connected to an external precision resistor (to VDD) that is indicative of the PCI/PCI-X trace load. This cell is used to dynamically determine the drive strength required on the N-channel transistors in the PCI/PCI-X I/O cells. The internal pull-up impedance is nominally 120 K $\Omega$ with a minimum of 90 K $\Omega$ and a maximum of 190 K $\Omega$ .
ZP_COMP	I/O	<b>P Device Impedance Compensation.</b> This signal should be connected to an external precision resistor (to VSS) that is indicative of the PCI/PCI-X trace load. This cell is used to dynamically determine the drive strength required on the P-channel transistors in the PCI/PCI-X I/O cells. The internal pull-up impedance is nominally 120 K $\Omega$ with a minimum of 90 K $\Omega$ and a maximum of 190 K $\Omega$ .

### 3.2.8 SMB Signals

**Note:** A pull-up resistor with a recommended value of 4.7 K $\Omega$  should be placed along the SMB. A precise value may be calculated from the SMB specification.

Symbol	Type	Name and Function
SMBCLK	I/O	<b>SMB Clock.</b> The SMB Clock signal is an open drain signal for serial SMB interface.
SMBDATA	I/O	<b>SMB Data.</b> The SMB Data signal is an open drain signal for serial SMB interface.
SMBALRT #	O	<b>SMB Alert.</b> The SMB Alert signal is open drain for serial SMB interface.

### 3.3 EEPROM Interface Signals

Symbol	Type	Name and Function
EE_DI	O	<b>EEPROM Data Input.</b> The EEPROM Data Input pin is used for output to the memory device.
EE_DO	I	<b>EEPROM Data Output.</b> The EEPROM Data Output pin is used for input from the memory device. The EE_DO includes an internal pull-up resistor.
EE_CS	O	<b>EEPROM Chip Select.</b> The EEPROM Chip Select signal is used to enable the device.
EE_SK	O	<b>EEPROM Serial Clock.</b> The EEPROM Shift Clock provides the clock rate for the EEPROM interface, which is approximately 1 MHz.



## 3.4 Flash Interface Signals

Symbol	Type	Name and Function
FL_ADDR [18:0]	O	<b>Flash Address Output.</b> The Flash Address Output signals are used for a Flash or Boot ROM device.
FL_CS#	O	<b>Flash Chip Select.</b> The Flash Chip Select signal is used to enable the Flash or Boot ROM device.
FL_OE#	O	<b>Flash Output Enable.</b> The Flash Output Enable signal is used to enable the Flash buffers.
FL_WE#	O	<b>Flash Write Enable Output.</b> The Flash Write ENable Output signals are used for write cycles.
FL_DATA [7:1]	TS	<b>Flash Data I/O.</b> The Flash Data I/O signals are bi-directional and used for Flash data. These signals include internal pull-up devices.
FL_DATA[0] / LAN_DISABLE#	TS	<b>Flash Data I/O / LAN Disable.</b> This pin is an input from the Flash memory. Alternatively, the pin can be used to disable the LAN port from a system General Input Output (GPIO) port. It has an internal pull-up device. If the 82545GM is not using Flash functionality, the pin should be connected to external pull-up resistor. If this pin is used as LAN_DISABLE, the device transitions to a low power state, and the LAN port is disabled when this pin is sampled low on the rising edge of PCI reset.

## 3.5 Miscellaneous Signals

### 3.5.1 LED Signals

Symbol	Type	Name and Function
ACT#	O	<b>Activity.</b> The Activity LED signal flashes an LED to indicate receive activity on the Ethernet port for packets only destined to this node.
LINK#	O	<b>Link.</b> The Link LED signal indicates link connectivity on the Ethernet port.
LINK100#	O	<b>Link 100.</b> The Link 100 signal drives an LED indicating link at 100 Mbps on the Ethernet port.
LINK1000#	O	<b>Link 1000.</b> The Link 1000 signal drives an LED indicating link at 1000 Mbps on the Ethernet port.

### 3.5.2 Software Definable Signals

Symbol	Type	Name and Function
SDP[7:6] SDP[1:0]	TS	<b>Software Defined Pin.</b> The Software Defined Pins are reserved and programmable with respect to input and output capability. These default to input signals upon power-up but may be configured differently by the EEPROM. The upper four bits may be mapped to the General Purpose Interrupt bits if they are configured as input signals. Note: SDP5 is not included in the group of Software Defined Pins.



## 3.6 PHY Signals

### 3.6.1 Crystal Signals

Symbol	Type	Name and Function
XTAL1	I	<b>Crystal One.</b> The Crystal One pin is a 25 MHz +/- 30 ppm input signal. It can be connected to a 25 MHz crystal. Crystal Two (XTAL2) must also be connected.
XTAL2	O	<b>Crystal Two.</b> Crystal Two is the output of an internal oscillator circuit used to drive a crystal into oscillation. If an external oscillator is used in the design, XTAL2 must be disconnected.

### 3.6.2 Analog Signals

Symbol	Type	Name and Function
REF	P	<b>Reference.</b> This Reference signal should be connected to VSS through an external 2.49 KΩ resistor.
MDI[0]+/-	A	<p><b>Media Dependent Interface [0].</b></p> <p><b>100BASE-T:</b> In MDI configuration, MDI[0]+/- corresponds to BI_DA+/-, and in MDI-X configuration, MDI[0]+/- corresponds to BI_DB+/-.</p> <p><b>100BASE-TX:</b> In MDI configuration, MDI[0]+/- is used for the transmit pair, and in MDI-X configuration, MDI[0]+/- is used for the receive pair.</p> <p><b>10BASE-T:</b> In MDI configuration, MDI[0]+/- is used for the transmit pair, and in MDI-X configuration, MDI[0]+/- is used for the receive pair.</p>
MDI[1]+/-	A	<p><b>Media Dependent Interface [1].</b></p> <p><b>100BASE-T:</b> In MDI configuration, MDI[1]+/- corresponds to BI_DB+/-, and in MDI-X configuration, MDI[1]+/- corresponds to BI_DA+/-.</p> <p><b>100BASE-T:</b> In MDI configuration, MDI[1]+/- is used for the receive pair, and in MDI-X configuration, MDI[1]+/- is used for the transmit pair.</p> <p><b>10BASE-T:</b> In MDI configuration, MDI[1]+/- is used for the receive pair, and in MDI-X configuration, MDI[1]+/- is used for the transmit pair.</p>
MDI[2]+/-	A	<p><b>Media Dependent Interface [2].</b></p> <p><b>100BASE-T:</b> In MDI configuration, MDI[2]+/- corresponds to BI_DC+/-, and in MDI-X configuration, MDI[2]+/- corresponds to BI_DD+/-.</p> <p><b>100BASE-TX:</b> Unused.</p> <p><b>10BASE-T:</b> Unused.</p>
MDI[3]+/-	A	<p><b>Media Dependent Interface [3].</b></p> <p><b>100BASE-T:</b> In MDI configuration, MDI[3]+/- corresponds to BI_DD+/-, and in MDI-X configuration, MDI[3]+/- corresponds to BI_DC+/-.</p> <p><b>100BASE-TX:</b> Unused.</p> <p><b>10BASE-T:</b> Unused.</p>



## 3.7 Serializer / Deserializer (SERDES) Signals

Symbol	Type	Name and Function
RX +/-	I	<b>SERDES Receive Pair.</b> These two signals comprise the differential receive pair for the 1.25 GHz serial interface. If the SERDES interface is not used, these signals should not be connected.
TX +/-	O	<b>SERDES Transmit Pair.</b> These two signals comprise the differential transmit pair for the 1.25 GHz serial interface. If the SERDES interface is not used, these signals should not be connected.
SIG_DETECT	I	<b>Signal Detect.</b> This pin indicates when a SERDES signal (connected to the 1.25 GHz serial interface) has been detected by the optical transceiver. If the SERDES interface is not used, this signal should be connected to ground through a pull-down resistor.

## 3.8 JTAG Test Interface Signals

Symbol	Type	Name and Function
JTAG_TCK	I	<b>JTAG Clock.</b>
JTAG_TDI	I	<b>JTAG TDI.</b>
JTAG_TDO	O	<b>JTAG TDO.</b>
JTAG_TMS	I	<b>JTAG TMS.</b>
JTAG_TRST#	I	<b>JTAG Reset.</b> This is an active low reset signal for JTAG. This signal should be terminated using a pull-down resistor to ground. It must not be left unconnected.
CLK_VIEW	O	<b>Clock View.</b> The Clock View signal is an output for the clock signals required for IEEE testing. The clock is selected by register programming. For IEEE testing, a 2-pin header should be connected to CLK_VIEW with one signal connected to GND, and the other, to CLK_VIEW.
TEST#	I	<b>Factory Test Pin.</b> This is an active low input and has an internal pull-up resistor. For normal operation, TEST# should be left unconnected.

## 3.9 Power Supply Connections

### 3.9.1 Power Support Signals

Symbol	Type	Name and Function
CTRL_15	A	<b>1.5 V Control.</b> The 1.5 V Control signal is an output to an external power transistor. If regulators are used, it should be left unconnected.
CTRL_25	A	<b>2.5 V Control.</b> The 2.5 V Control signal is an output to an external power transistor. If regulators are used, it should be left unconnected.



### 3.9.2 Digital Supplies

Symbol	Type	Name and Function
VDDO	P	3.3 V I/O Power Supply.
DVDD	P	1.5 V Digital Core Power Supply.

### 3.9.3 Analog Supplies

Symbol	Type	Name and Function
AVDDH	P	3.3 V Analog Power Supply.
AVDDL	P	2.5 V Analog Power Supply.

### 3.9.4 Ground and No Connects

Symbol	Type	Name and Function
GND	P	<b>Ground.</b>
NC	P	<b>No Connect.</b> Do not connect any circuitry to these pins. Pull-up or pull-down resistors should not be connected to these pins.
Reserved	R	<b>Reserved.</b> These pins are reserved for factory purposes and should be pulled down to ground through a pull-down resistor.



*Note:* This page is intentionally left blank.

## 4.0 Test Port Functionality

### 4.1 XOR Testing

A common board or system-level manufacturing test for proper electrical continuity between a silicon component and the board is some type of cascaded-XOR or NAND tree test. The 82545GM implements an XOR tree spanning most I/O signals. The component XOR tree consists of a series of cascaded XOR logic gates, each stage feeding in the electrical value from a unique pin. The output of the final stage of the tree is visible on an output pin from the component.

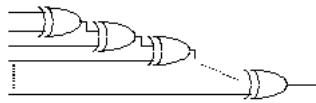

**Figure 2. XOR Tree Concept**

By connecting to a set of test-points or bed-of-nails fixture, a manufacturing test fixture can test connectivity to each of the component pins included in the tree by sequentially testing each pin, testing each pin when driven both high and low, and observing the output of the tree for the expected signal value and/or change.

#### 4.1.1 XOR Tree Control and Operation

The following signals are required to place the 82545GM in XOR tree test mode:

Test Function/ Mode	Pin Name	TEST_DM_N	EWRAP	CLK_BYP_N	CLK_VIEW	SDP_B[7]
	Dual-Mode Name		TEST_MODE[3]	TEST_MODE[2]	TEST_MODE[1]	TEST_MODE[0]
XOR Tree Test		0	0	0	0	0



I/O pins with dual-mode function for XOR test:

Pin Name	Dual-Mode Name	Pin Function
FLSH_CE_N	XOR_OUT	Output of XOR tree.

When XOR tree test is selected, the following pin behavior(s) occur:

- Output drivers for the pins listed as tested are all placed in high-impedance (tri-state) state to ensure that the board/system test fixture can drive the tested inputs without contention
- The output driver for the XOR tree output on pin FLSH\_CE\_N is explicitly enabled.

## 4.1.2 Pins Tested

When performing XOR test, those pins tested by the XOR tree all function as inputs, regardless of the normal directionality of the pin. The following table(s) cites the pins tested and not-testable as inputs to the XOR tree. Table entries do not reflect the natural order of input into the XOR tree itself (nor need to, as the output of a multi-input XOR function is order-independent).

Pins included in XOR test tree are listed in [Table 1](#):

**Table 1. Tested Pins Included in XOR Tree**

Pin Name	Pin Name	Pin Name
PCI_AD[63:0]	M66EN	RX_DATA[7:0]
PCI_CBE_N[7:0]	PCI_RST_N	RBC0/RX_CLK
PCI_PAR	LAN_PWR_GOOD	RBC1/MTX_CLK
PCI_PAR64	PCI_SERR_N	EE_DI
PCI_FRAME_N	PCI_PERR_N	EE_DO
PCI_IRDY_N	PCI_PME_N	EE_CS
PCI_TRDY_N	AUX_PWR	EE_SK
PCI_STOP_N	SMBCLK	FLSH_ADDR[18:0]
PCI_IDSEL	SMBDAT	FLSH_OE_N
PCI_DEVSEL_N	TX_DATA[9]/TX_ER	FLSH_WE_N
PCI_REQ64_N	TX_DATA[8]/TX_EN	FLSH_DATA[7:0]
PCI_ACK64_N	TX_DATA[7:0]	LED_A[3:0]
PCI_REQ_N	GTX_CLK	LED_B[3:0]
PCI_GNT_N	COL	SDP_A[7,6,1,0]
PCI_LOCK_N	CRS	SDP_B[6,1,0]
PCI_INTA_N	LINK/LOS	ALTCLK_125
PCI_INTB_N	RX_DATA[9]/RX_ER	
PCI_CLK	RX_DATA[8]/RX_DV	





Pins not included in XOR test tree:

- JTAG (TAP) interface: TRST\_N, TCK, TDO, TMS, and TDI
- Test mode decode controls TEST\_DM\_N, EWRAP, CLK\_BYP\_N, CLK\_VIEW, and SDP\_B[7]
- Each internal PHY's analog signals including PHYREF, MDI +/-, and PHY\_HSDACP/N
- PCI Impedance Compensation ZPCOMP and ZNCOMP
- Oscillator signals XTAL1 and XTAL2
- Test signals including PHY\_TSTPT and each PHY's HSDACP/N
- Power-control pins CTRL\_15, CTRL\_25\_A, and CTRL\_25\_B
- SMB\_ALERT\_N/PCI\_PWR\_GOOD

## 4.2 Tristate Mode

The 82545GM's tristate test mode is used to explicitly disable output drivers and place outputs in high-impedance (tristate) state. To more readily support XOR or NAND-tree like testing of other system components, the 82545GM decodes this test mode from the same signal pins used to exercise XOR tree testing. The 82545GM additionally supports a mechanism to enter tristate mode via the IEEE 802.3 JTAG (TAP) controller.

### 4.2.1 Tristate Mode Control and Operation

The following signals are required to place the 82545GM in tristate test mode:

Test Function/ Mode	Pin Name	TEST_DM_N	EWRAP	CLK_BYP_N	CLK_VIEW	SDP_B[7]
	Dual-Mode Name		TEST_MODE[3]	TEST_MODE[2]	TEST_MODE[1]	TEST_MODE[0]
Tristate Mode		0	0	1	0	1

When in tristate test mode:

- All output drivers for all digital signal pins are disabled (with the exception of the TDO pin).
- Analog signals such as MDI+/-, analog test points, and regulator controls are unaffected.

### 4.2.2 Tristate Mode Using JTAG (TAP)

The 82545GM can also be placed in tristate mode using the JTAG interface and the HIGHZ instruction.

The HIGHZ instruction is used to place the 82545GM in high-impedance (TRISTATE) mode, where all digital signal outputs are placed in high-impedance (tri-state) output state.



*Note:* This page intentionally left blank.



## 5.0 Voltage, Temperature, and Timing Specifications

**Note:** The specification values listed in this section are subject to change without notice. Verify with your local Intel sales office that you have the latest information before finalizing a design.

### 5.1 Targeted Absolute Maximum Ratings

**Table 2. Absolute Maximum Ratings<sup>a</sup>**

Symbol	Parameter	Min	Max	Unit
VDD (3.3)	DC supply voltage on VDDD or AVDDH with respect to VSS	VSS - 0.5	4.6	V
VDD (2.5)	DC supply voltage on AVDDL with respect to VSS	VSS - 0.5	4.6 or VDD (2.5) + 0.5 <sup>b</sup>	V
VDD (1.5)	DC supply voltage on DVDD with respect to VSS	VSS - 0.5	4.6 or VDD (1.5) + 0.5 <sup>c</sup>	V
VDD	DC supply voltage	VSS - 0.5	4.6	V
VI / VO	LVTTTL input voltage	VSS - 0.5	4.6	V
VI / VO	5 V compatible input voltage	VSS - 0.5	6.6	V
IO	DC output current (by cell type): IOL = 3 mA IOL = 6 mA IOL - 12 mA		10 20 40	mA
TSTG	Storage temperature range	-40	125	C
	ESD per MIL_STD-883 Test Method 3015, Specification 2001V Latchup Over/Undershoot: 150 mA, 125 C		VDD overstress: VDD(3.3)(7.2 V)	V

- a. Maximum ratings are referenced to ground (VSS). Permanent device damage is likely to occur if the ratings in this table are exceeded. These values should not be used as the limits for normal device operations.  
b. The maximum value is the lesser value of 4.6 V or VDD(2.5) + 0.5 V. This specification applies to biasing the device to a steady state for an indefinite duration. During normal device power-up, explicit power sequencing is not required.  
c. The maximum value is the lesser value of 4.6 V or VDD(2.5) + 0.5 V.

### 5.2 Recommended Operating Conditions

**Table 3. Recommended Operating Conditions<sup>a</sup>**

Symbol	Parameter	Min	Max	Unit
VDD (3.3)	DC supply voltage on VDDD or AVDDH <sup>b</sup>	3.0	3.6	V
VDD (2.5)	DC supply voltage on AVDDL <sup>c</sup>	2.38	2.62	V
VDD (1.5)	DC supply voltage on DVDD	1.43	1.57	V
VIO	PCI bus voltage reference	3.0	5.25	V

**Table 3. Recommended Operating Conditions<sup>a</sup>**

Symbol	Parameter	Min	Max	Unit
tR / tF	Input rise/fall time (normal input)	0	200	ns
tr/tf	input rise/fall time (Schmitt input)	0	10	ms
TA	Operating temperature range (ambient)	0	70	C
TJ	Junction temperature		≤125	C

- a. Sustained operation of the device at conditions exceeding these values, even if they are within the absolute maximum rating limits, might result in permanent damage.
- b. It is recommended for VDDO to equal AVDDH (VDDO = AVDDH) during power-up and normal operation.
- c. It is recommended for both VDDO and AVDDH to be of a value greater than AVDDL, with a value greater than DVDD, during power-up (VDDO or AVDDH > AVDDL > DVDD).

## 5.3 DC Specifications

**Table 4. DC Characteristics**

Symbol	Parameter	Min	Typ	Max	Units
VDD (3.3)	DC supply voltage on VDDO or AVDDH	3.00	3.3	3.60	V
VDD (2.5)	DC supply voltage on AVDDL	2.38	2.5	2.62	V
VDD (1.5)	DC supply voltage on DVDD	1.43	1.5	1.57	V

**Table 5.a Power Supply Characteristics**

	D0a							
	Unplugged/No Link		10 Mbps Operation		100 Mbps Operation		1000 Mbps Operation	
	Typ <sup>a</sup> Icc (mA)	Max <sup>b</sup> Icc (mA)	Typ Icc (mA)	Max Icc (mA)	Typ Icc (mA)	Max Icc (mA)	Typ Icc (mA)	Max Icc (mA)
3.3 V	45	50	65	70	65	70	135	155
2.5 V	25	30	40	50	70	75	165	175
1.5 V	85	95	90	105	120	130	400	425
Total Device Power	350 mW		450 mW		575 mW		1.45 W	1.7 W

- a. Typical conditions: operating temperature (TA) = 25 C, nominal voltages, moderate network traffic at full duplex, and PCI 66 MHz system interface.
- b. Maximum conditions: minimum operating temperature (TA) values, maximum voltage values, and PCI-X 100 to 133 MHz system interface.



Table 5.b

	D3cold - Wake Up Enabled						D3cold - Wake Up Disabled	
	Unplugged/No Link		10 Mbps Operation		100 Mbps Operation		Typ Icc (mA)	Max Icc (mA)
	Typ <sup>a</sup> Icc (mA)	Max <sup>b</sup> Icc (mA)	Typ Icc (mA)	Max Icc (mA)	Typ Icc (mA)	Max Icc (mA)		
3.3 V	40	45	55	60	50	55	40	45
2.5 V	30	30	30	30	60	65	30	30
1.5 V	30	35	30	35	55	60	10	10
Total Device Power	250 mW		300 mW		400 mW		225 mW	

- a. Typical conditions: operating temperature (TA) = 25 C, nominal voltages, moderate network traffic at full duplex, and PCI 66 MHz system interface.
- b. Maximum conditions: minimum operating temperature (TA) values, maximum voltage values, and PCI-X 100 to 133 MHz system interface.

Table 5.c

	Uninitialized/Disabled			
	D(n) Uninitialized (LAN PWR GOOD = 0)		Disabled (via Flash Address)	
	Typ <sup>a</sup> Icc (mA)	Max <sup>b</sup> Icc (mA)	Typ Icc (mA)	Max Icc (mA)
3.3 V	40	45	40	45
2.5 V	40	45	25	30
1.5 V	190	200	10	15
Total Device Power	520 mW		210 mW	

- a. Typical conditions: operating temperature (TA) = 25 C, nominal voltages, moderate network traffic at full duplex, and PCI 66 MHz system interface.
- b. Maximum conditions: minimum operating temperature (TA) values, maximum voltage values, and PCI-X 100 to 133 MHz system interface.



Table 5.d

	Complete Subsystem (including magnetics, LED, and regulator circuits)							
	D3cold / Wake disabled		D3cold / Wake Enabled at 10 Mbps		D3cold / Wake Enabled at 100 Mbps		D0 at 1000 Mbps	
	Typ <sup>a</sup> Icc (mA)	Max <sup>b</sup> Icc (mA)	Typ Icc (mA)	Max Icc (mA)	Typ Icc (mA)	Max Icc (mA)	Typ Icc (mA)	Max Icc (mA)
3.3 V	40	45	60	65	60	65	140	160
2.5 V	30	30	40	40	85	90	260	270
1.5 V	10	10	30	35	55	60	400	425
Subsystem 3.3 V Current		85 mA		140 mA		215 mA		855 mA

a. Typical conditions: operating temperature (TA) = 25 C, nominal voltages, moderate network traffic at full duplex, and PCI 66 MHz system interface.

b. Maximum conditions: minimum operating temperature (TA) values, maximum voltage values, and PCI-X 100 to 133 MHz system interface.

**NOTE:** Component power has been specified separately from subsystem power to aid in calculating thermal operation and in providing external power supply circuits. Complete subsystem power is specified to aid in providing overall power supply design for the applications.

Table 6.a MAC/SERDES Characteristics

	Component Only			
	D0a (SERDES Active)		D3cold - Wake Disabled (SERDES Off)	
	Typ Icc (mA)	Max Icc (mA)	Typ Icc (mA)	Max Icc (mA)
3.3 V	65	75	45	50
2.5 V	60	70	leakage	leakage
1.5 V	115	130	5	5
Total Device Power	540 mW	660 mW	150 mW	200 mW



Table 6.b

Complete Subsystem (Reference SERDES Design) Including LED, Regulator Circuits (no optics)				
D3cold Wake Disabled (Auxiliary Power)		D0 SERDES Active (Primary Power)		
	Typ I <sub>cc</sub> (mA)	Max I <sub>cc</sub> (mA)	Typ I <sub>cc</sub> (mA)	Max I <sub>cc</sub> (mA)
3.3 V	45	50	70	80
2.5 V	-0	-0	60	70
1.5 V	5	5	115	130
Subsystem 3.3 V Current		55 mA		280 mA

**NOTE:** In fiber/optical application or SERDES driven backplane application, power is substantially less than when operating with a PHY/magnetics. For calculating thermal operations and in providing external power-supply circuits for such applications, SERDES mode power is provided separately. Power is specified into a load of 50 pF at default SERDES amplitude setting. Power consumed by optics module (if present) is not included.

**NOTE:** Power specifications for uninitialized/disabled state are detailed under the copper MAC/PHY specifications.

Table 7. I/O Characteristics

Symbol	Parameter	Condition	Min	Typ	Max	Unit
V <sub>IL</sub>	Voltage input LOW		-0.5		0.8	V
V <sub>IH</sub>	Voltage input HIGH		2.0		V <sub>DD</sub> +0.3	V
V <sub>OL</sub>	Voltage output LOW				0.4	V
V <sub>OH</sub>	Voltage output HIGH		2.4			V
V <sub>SH</sub>	Schmitt Trigger Hysteresis		0.1			V
I <sub>OL</sub> <sup>a</sup>	Output current LOW					
	3mA drivers (TTL3)	V <sub>OL</sub>	3			mA
	6mA drivers (TTL6)	V <sub>OL</sub>	6			mA
	12mA drivers (TTL12)	V <sub>OL</sub>	12			mA
I <sub>OH</sub> <sup>a</sup>	Output current HIGH					
	3mA drivers (TTL3)	V <sub>OH</sub>	-3			mA
	6mA drivers (TTL6)	V <sub>OH</sub>	-6			mA
	12mA drivers (TTL12)	V <sub>OH</sub>	-12			mA
I <sub>IN</sub>	Input Current					
	TTL inputs	V <sub>IN</sub> = V <sub>DD</sub> or V <sub>SS</sub>	-10	±1	10	μA
	Inputs with pull-down resistors	V <sub>IN</sub> = V <sub>DD</sub>	150		480	μA
	TTL inputs with pull-up resistors	V <sub>IN</sub> = V <sub>SS</sub>	-150		-480	μA
I <sub>OZ</sub>	3-state output leakage current	V <sub>OH</sub> = V <sub>DD</sub> or V <sub>SS</sub>	-10	±1	10	μA



Table 7. I/O Characteristics

Symbol	Parameter	Condition	Min	Typ	Max	Unit
C <sub>IN</sub>	Input capacitance	Any input and bi-directional buffer		2.5		pF
C <sub>OUT</sub>	Output capacitance	Any output buffer		2.0		pF
C <sub>PUD</sub>	Pull-up/down Resistor value		7.5		20	kΩ

- a. TTL3 signals include: EE\_DI, EE\_SK, EE\_CS, and JTAG\_TDO.  
 TTL6 signals include: FL\_CE#, CLK\_VIEW, FL\_DATA[7:0], FL\_ADDR[18:0], FL\_OE#, and FL\_WE#.  
 TTL12 signals include: LED0 / LINK #, LED1 / ACT #, LED2 / LINK100 #, LED3 / LINK1000 #, SDP0, SDP1, SDP6, and SDP7.

## 5.4 AC Characteristics

Table 8. AC Characteristics: 3.3 V Interfacing

Symbol	Parameter	Min	Typ	Max	Unit
fPCICLK	Clock frequency in PCI mode			66	MHz
fPCICLK	Clock frequency in PCI-X mode	66		133	MHz

Table 9. 25 MHz Clock Input Requirements

Symbol	Parameter <sup>a</sup>	Min	Typ	Max	Unit
fi_TX_CLK	TX_CLK_IN frequency	25 - 50 ppm	25	25 + 50 ppm	MHz

- a. This parameter applies to an oscillator connected to the Crystal One (XTAL1) input. Alternatively, a crystal may be connected to XTAL1 and XTAL2 as the frequency source for the internal oscillator.



**Table 10. Link Interface Clock Requirements**

Symbol	Parameter	Min	Typ	Max	Unit
fGTX <sup>a</sup>	GTX_CLK frequency		125		MHz

a. GTX\_CLK is used externally for test purposes only.

**Table 11. EEPROM Interface Clock Requirements**

Symbol	Parameter	Min	Typ	Max	Unit
fSK				1	MHz

**Table 12. AC Test Loads for General Output Pins**

Symbol	Signal Name	Value	Units
CL	TDO	10	pF
CL	APM_WAKEUP, PME#, SDP[7:6], SDP[1:0]	16	pF
CL	EE_DI, EE_SK, FL_ADDR[18:0], FL_CS#, FL_OE#, FL_WE#, FL_DATA[7:0]	18	pF
CL	RX_ACTIVITY, TX_ACTIVITY, LINK_UP	20	pF

**Figure 3. AC Test Loads for General Output Pins**

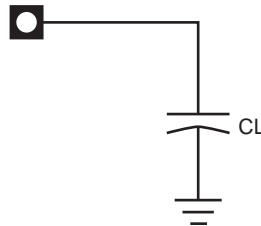

## 5.5 Serial Interface Specifications

**Table 13. Driver Characteristics**

Symbol	Parameter	Min	Typ	Max	Units
V <sub>OD</sub>	Differential Output Voltage Swing <sup>a</sup>	875		1325	mV peak-peak
V <sub>OS</sub>	Output Offset Voltage	1075		1325	mV
Delta V <sub>OD</sub>	Change in V <sub>OD</sub> between 0 and 1 <sup>b</sup>			25	mV

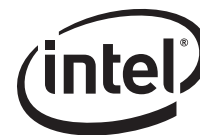

Table 13. Driver Characteristics

Symbol	Parameter	Min	Typ	Max	Units
$R_O$	Differential Output Impedance	80		120	$\Omega$
$I_{SA}, I_{SB}$	Output Current on Short to VSS			40	mA
$I_{SAB}$	Output Current when A and B are Shorted			12	mA

- a. This is the maximum inside dimension of the eye pattern, measured on high and low data patterns with pre-emphasis present. Load - 100  $\Omega$ .
- b. This is defined as an absolute value of amplitude jitter.

Table 14. Receiver Characteristics

Symbol	Parameter	Min	Typ	Max	Units
$V_{ID}$	Differential Input Voltage Swing	100		2000	mV peak-peak
$R_{IN}$	Differential Input Impedance	80		120	$\Omega$

## 5.6 Timing Specifications

**Note:** Timing specifications are preliminary and subject to change. Verify with your local Intel sales office that you have the latest information before finalizing a design.

### 5.6.1 PCI/PCI-X Bus Interface

#### 5.6.1.1 PCI/PCI-X Bus Interface Clock

Table 15. PCI/PCI-X Bus Interface Clock Parameters

Symbol	Parameter <sup>a</sup>	PCI-X 133 MHz		PCI-X 66 MHz		PCI 66MHz		PCI 33 MHz		Units
		Min	Max	Min	Max	Min	Max	Min	Max	
TCYC	CLK cycle time	7.5	20	15	20	15	30	30		ns
TH	CLK high time	3		6		6		11		ns
TL	CLK low time	3		6		6		11		ns
	CLK slew rate	1.5	4	1.5	4	1.5	4	1	4	V/ns
	RST# slew rate <sup>b</sup>	50		50		50		50		mV/ns

- a. Rise and fall times are specified in terms of the edge rate measured in V/ns. This slew rate must be met across the minimum peak-to-peak portion of the clock waveform as shown.
- b. The minimum RST# slew rate applies only to the rising (de-assertion) edge of the reset signal and ensures that system noise cannot render a monotonic signal to appear bouncing in the switching range.

Figure 4. PCI/PCI-X Clock Timing

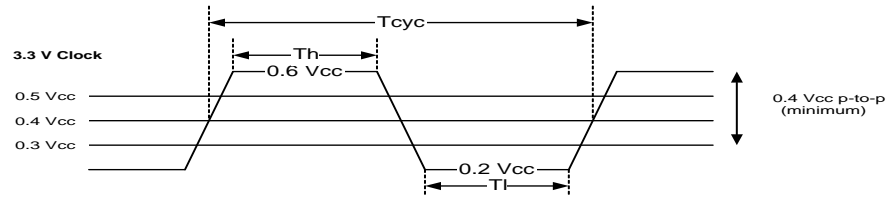

### 5.6.1.2 PCI/PCI-X Bus Interface Timing

Table 16. PCI/PCI-X Bus Interface Timing Parameters

Symbol	Parameter	PCI-X 133 MHz		PCI-X 66 MHz		PCI 66MHz		PCI 33 MHz		Units
		Min	Max	Min	Max	Min	Max	Min	Max	
TVAL	CLK to signal valid delay: bussted signals	0.7	3.8	0.7	3.8	2	6	2	11	ns
TVAL (ptp)	CLK to signal valid delay: point-to-point signals	0.7	3.8	0.7	3.8	2	6	2	12	ns
TON	Float to active delay	0		0		2		2		ns
TOFF	Active to float delay		7		7		14		28	ns
TSU	Input setup time to CLK: bussted signals	1.2		1.7		3		7		ns
TSU (ptp)	Input setup time to CLK: point-to-point signals	1.2		1.7		5		10, 12		ns
TH	Input hold time from CLK	0.5		0.5		0		0		ns
TRRSU	REQ64# to RST# setup time	10* TCYC		10* TCYC		10* TCYC		10* TCYC		ns
TRRH	RST# to REQ64# hold time	0		0		0		0		ns

**NOTES:**

1. Output timing measurements are as shown.
2. REQ# and GNT# signals are point-to-point and have different output valid delay and input setup times than bussted signals. GNT# has a setup of 10 ns; REQ# has a setup of 12 ns. All other signals are bussted.
3. Input timing measurements are as shown.



Figure 5. PCI Bus Interface Output Timing Measurement

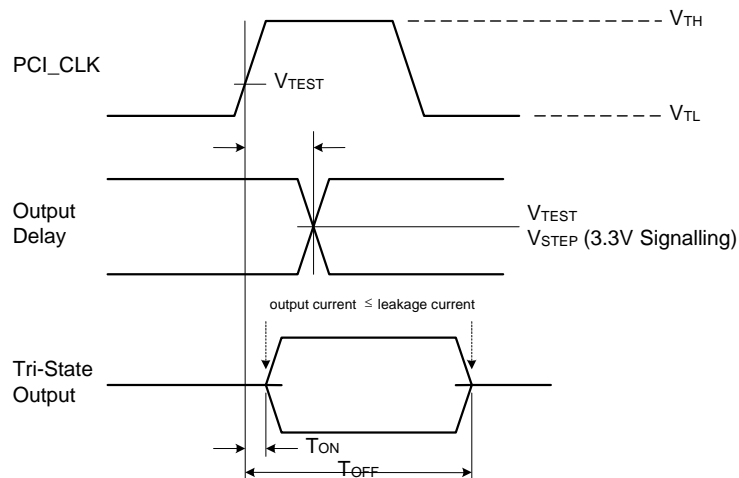

Figure 6. PCI Bus Interface Input Timing Measurement Conditions

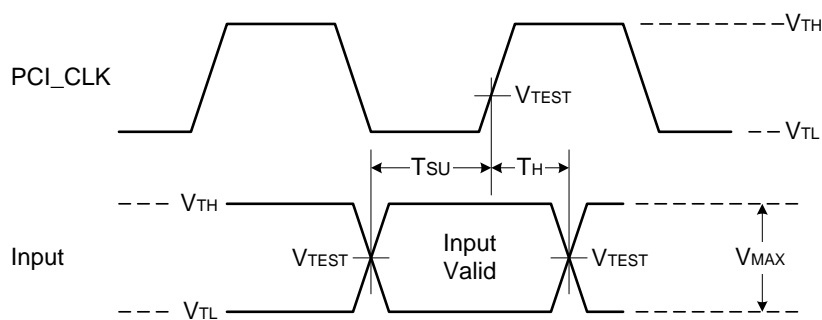

Table 13. PCI Bus Interface Timing Measurement Conditions

Symbol	Parameter	PCI-X	PCI 66 MHz 3.3 v	Unit
VTH	Input measurement test voltage (high)	0.6*VCC	0.6*VCC	V
VTL	Input measurement test voltage (low)	0.25*VCC	0.2*VCC	V
VTEST	Output measurement test voltage	0.4*VCC	0.4*VCC	V
	Input signal slew rate	1.5	1.5	V/ns

Figure 7. TVAL (max) Rising Edge Test Load

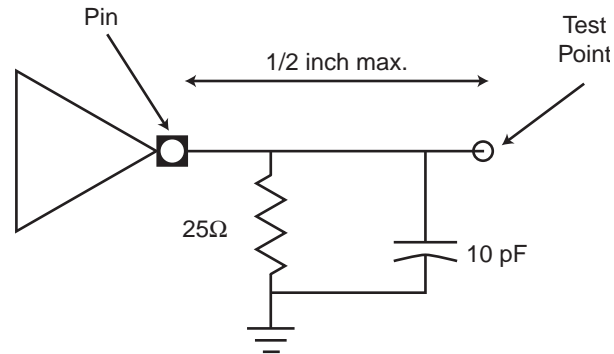
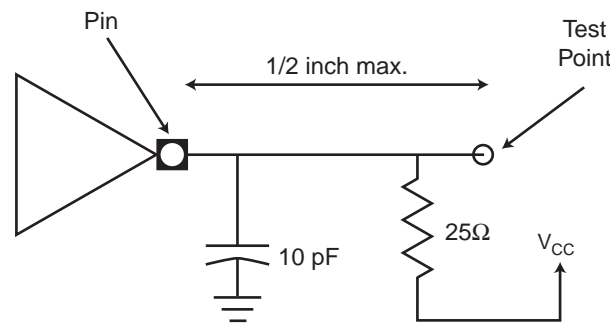

Figure 8. TVAL (max) Falling Edge Test Load



## 5.6.2 Link Interface Timing

### 5.6.2.1 Link Interface Rise and Fall Time

Table 17. Rise and Fall Times

Symbol	Parameter	Condition	Min	Max	Unit
TR	Clock rise time	0.8 V to 2.0 V	0.7		ns
TF	Clock fall time	2.0 V to 0.8 V	0.7		ns
TR	Data rise time	0.8 to 2.0 V	0.7		ns
TF	Data fall time	2.0 V to 0.8 V	0.7		ns



Figure 9. Link Interface Rise/Fall Timing

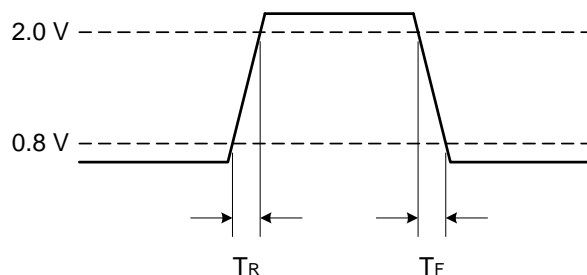

### 5.6.2.2 Link Interface Transmit Timing

Figure 10. Transmit Interface Timing

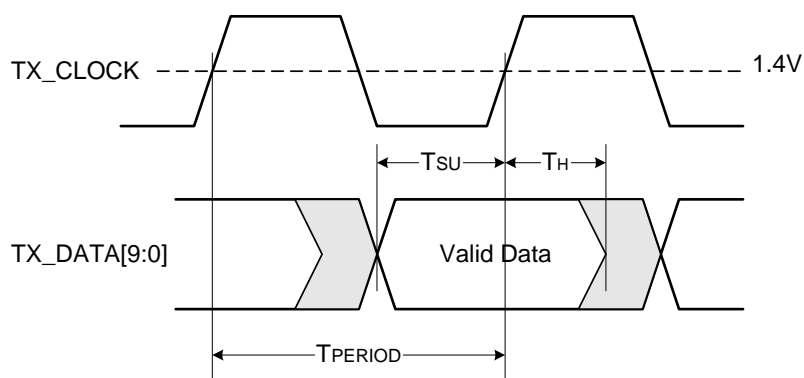

Table 18. Transmit Interface Timing

Symbol	Parameter	Min	Typ	Max	Unit
$T_{PERIOD}$	GTX_CLK period <sup>a</sup> TBI mode (1000 Mbps)		8		ns
$T_{SETUP}$	Data setup to rising GTX_CLK		2.5		ns
$T_{HOLD}$	Data hold from rising GRX_CLK		1.0		ns
$T_{DUTY}$	GTX_CLK duty cycle	40		60	%

a. GTX\_CLK should have a 100 ppm tolerance.

### 5.6.2.3 Link Interface Receive Timing

Figure 11. Receive Interface Timing

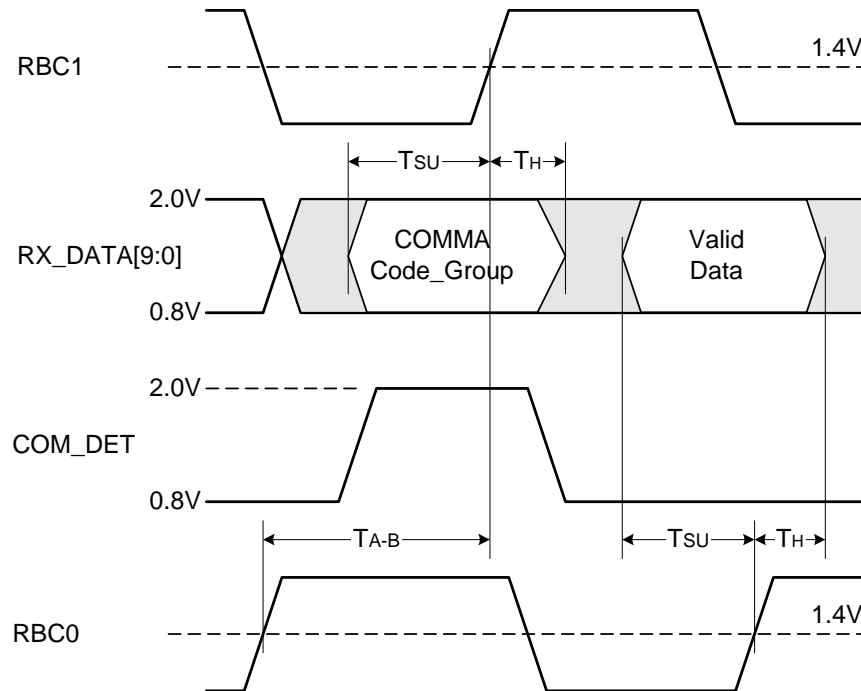

Table 19. Transmit Interface Timing

Symbol	Parameter	Min	Typ	Max	Unit
TREQ	RBC0/RBC1 frequency TBI mode (1000 Mbps)		62.5		MHz
TSETUP	Data setup before rising RBC0/RBC1		2.5		ns
THOLD	Data hold after rising RBC0/RBC1		1		ns
TDUTY	RBC0/RBC1 duty cycle	40		60	%
TA-B	RBC0/RBC1 skew	7.5		8.5	ns



### 5.6.3 Flash Interface

Figure 12. Flash Read Timing

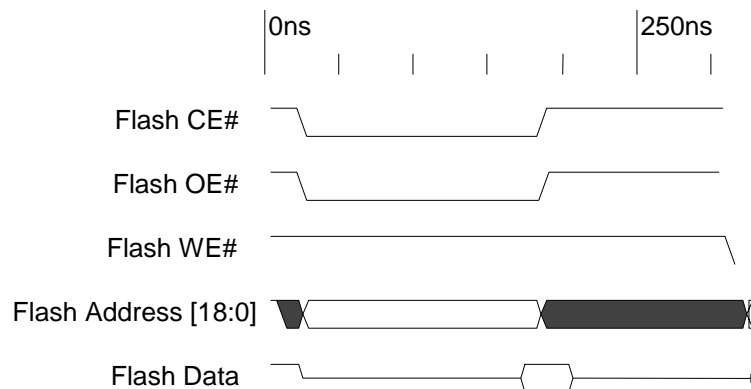
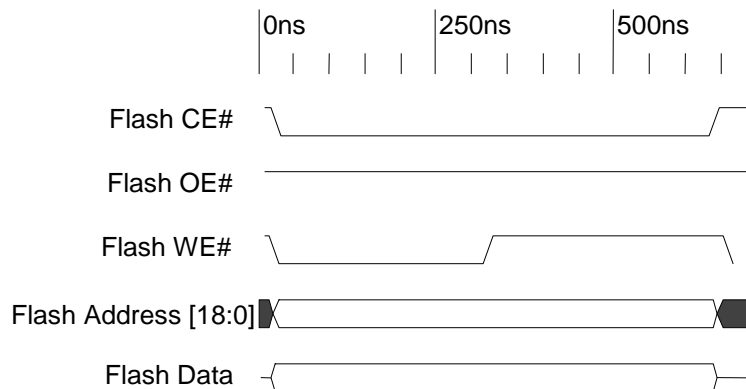

Table 20. Flash Read Operation Timing

Symbol	Parameter	Min	Typ	Max	Unit
TCE	Flash CE# or OE# to read data delay			160	ns
TACC	Flash address setup time			160	ns
THOLD	Data hold time	0			ns

Figure 13. Flash Write Timing







**Table 21. Flash Write Operation Timing**

Symbol	Parameter	Min	Typ	Max	Unit
TWE	Flash write pulse width (WE#)		160		ns
TAH	Flash address hold time	0			ns
TDS	Flash data setup time	160			ns

### 5.6.4 EEPROM Interface

**Table 22. Link Interface Clock Requirements**

Symbol	Parameter	Min	Typ	Max	Unit
TPW	EE_SK pulse width		TPERIOD*128		ns

**Table 23. Link Interface Clock Requirements**

Symbol	Parameter <sup>a</sup>	Min	Typ	Max	Unit
TDOS	EE_DO setup time	TCYC*2			ns
TDOH	EE_DO hold time	0			ns

a. The EE\_DO setup and hold time is a function of the CLK cycle time but is referenced to O\_EE\_SK.



*Note:* This page left intentionally blank.



## 6.0 Package and Pinout Information

---

### 6.1 Device Identification

Figure 14. 82545GM Device Identification Markings

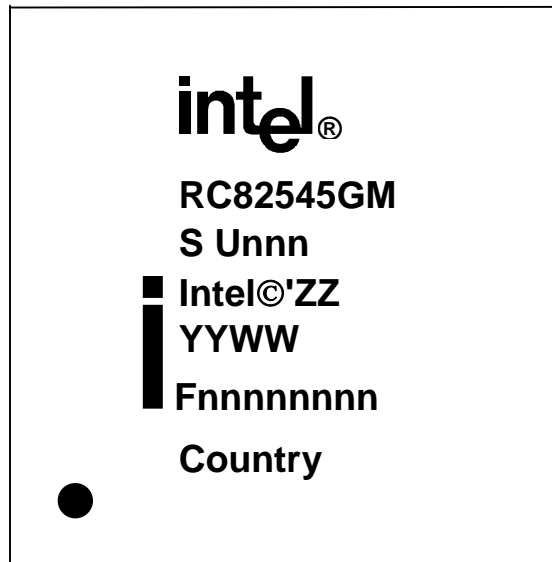

RC82545GM	Product Name
YYWW	Date Code
Fnnnnnnnn	Lot Trace Code
(c)'ZZ	Copyright Information
Country	Country of Origin Assembly

**NOTE:** The dot in the lower left corner indicates the location of pin 1.



## 6.2 Lead-Free Device Identification

Figure 15. Lead-Free 82545GM Device Identification Markings

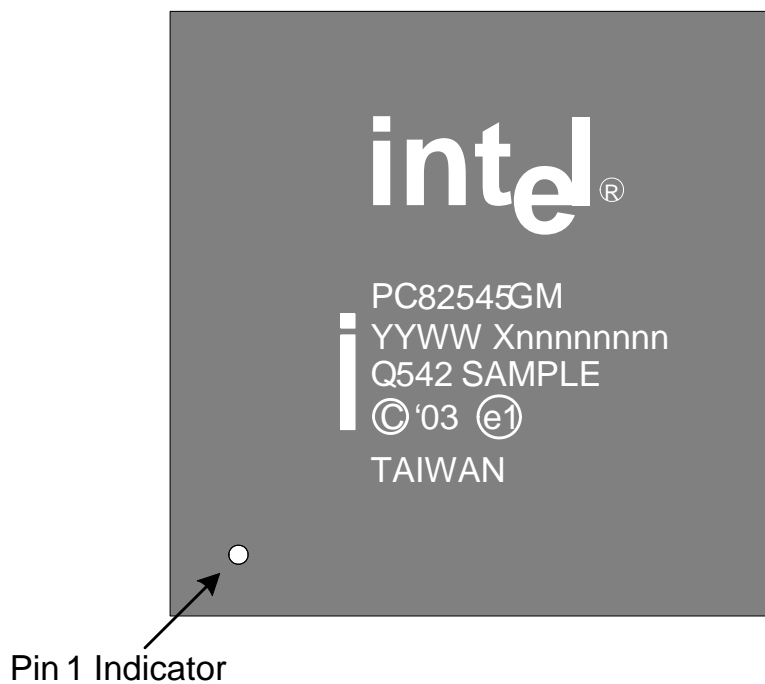

PC82545GM	Product Name
YYWW	Date Code
Xnnnnnnnn	Lot Trace Code
(c)'03 (e1)	Copyright Information and Lead-Free Mark
Taiwan	Country of Origin Assembly

### 6.3 Package Information

The 82545GM device is a 364-lead ball grid array (BGA) measuring 21 mm<sup>2</sup>. The package dimensions are detailed in the figures below. The nominal ball pitch is 1 mm.

**Figure 16. 82545GM 364-Lead BGA Ball Pad Dimensions**

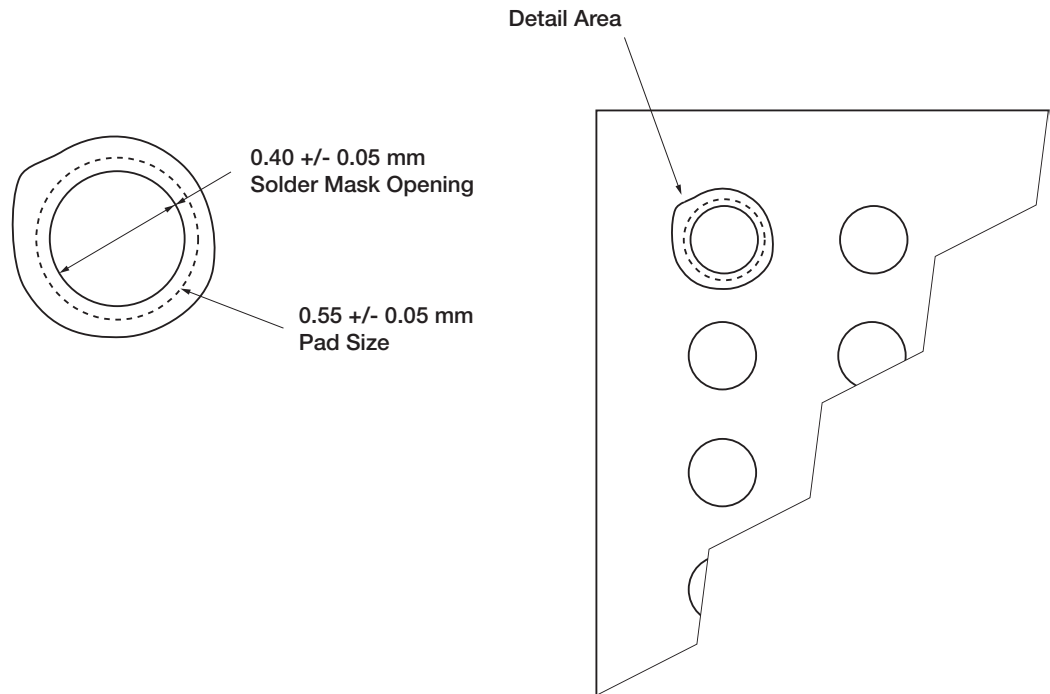
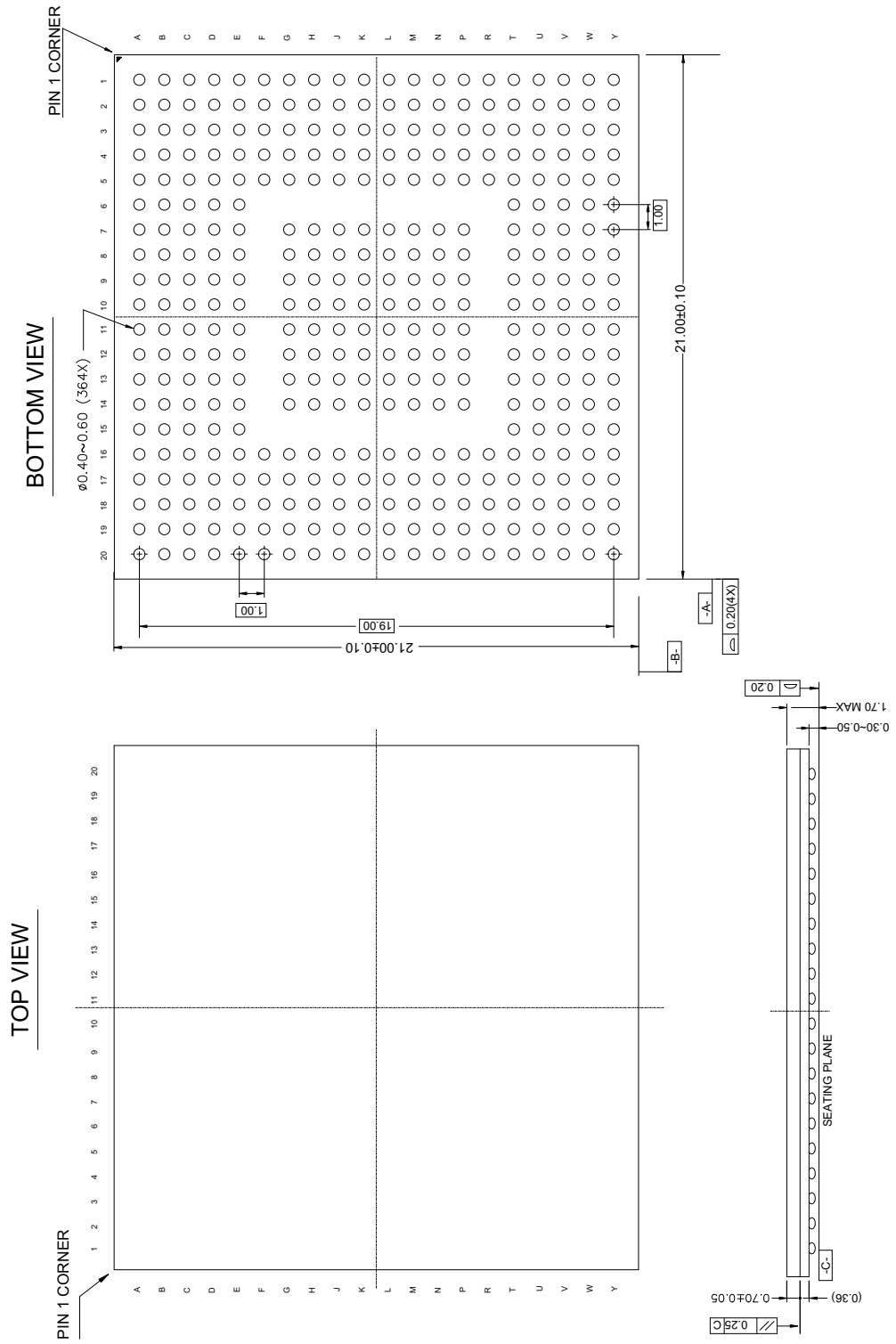



Figure 17. 82545GM Mechanical Specifications





## 6.4 Thermal Specifications

The 82545GM device is specified for operation when the ambient temperature (TA) is within the range of 0° C (minimum ambient temperature) to 70° C (maximum ambient temperature). The maximum junction temperature for the device is 120° C.

TC (case temperature) is calculated using the equation:

$$TC = TA + P (\theta_{JA} - \theta_{JC})$$

TJ (junction temperature) is calculated using the equation:

$$TJ = TA + P \theta_{JA}$$

P (power consumption) is calculated by using the typical ICC and nominal VCC. The thermal resistances are shown in [Table 24](#).

**Table 24. Thermal Characteristics**

Symbol	Parameter	Value at specified airflow (m/s)			Units
		0	1	2	
$\theta_{JA}$	Thermal resistance, junction-to-ambient	19.2	17.1	15.4	C/Watt
$\theta_{JC}$	Thermal resistance, junction-to-case	4.6	4.6	4.6	C/Watt

Thermal resistances are determined empirically with test devices mounted on standard thermal test boards. Real system designs may have different characteristics due to board thickness, arrangement of ground planes, and proximity of other components. The case temperature measurements should be used to assure that the 82545GM device is operating under recommended conditions.



## 6.5 Ball Mapping Diagram

**Note:** The 82545GM device uses five categories of VDD connections: VDDO (3.3 V), AVDDH (Analog 3.3 V), AVDDL (Analog 2.5 V), and DVDD (1.5 V).

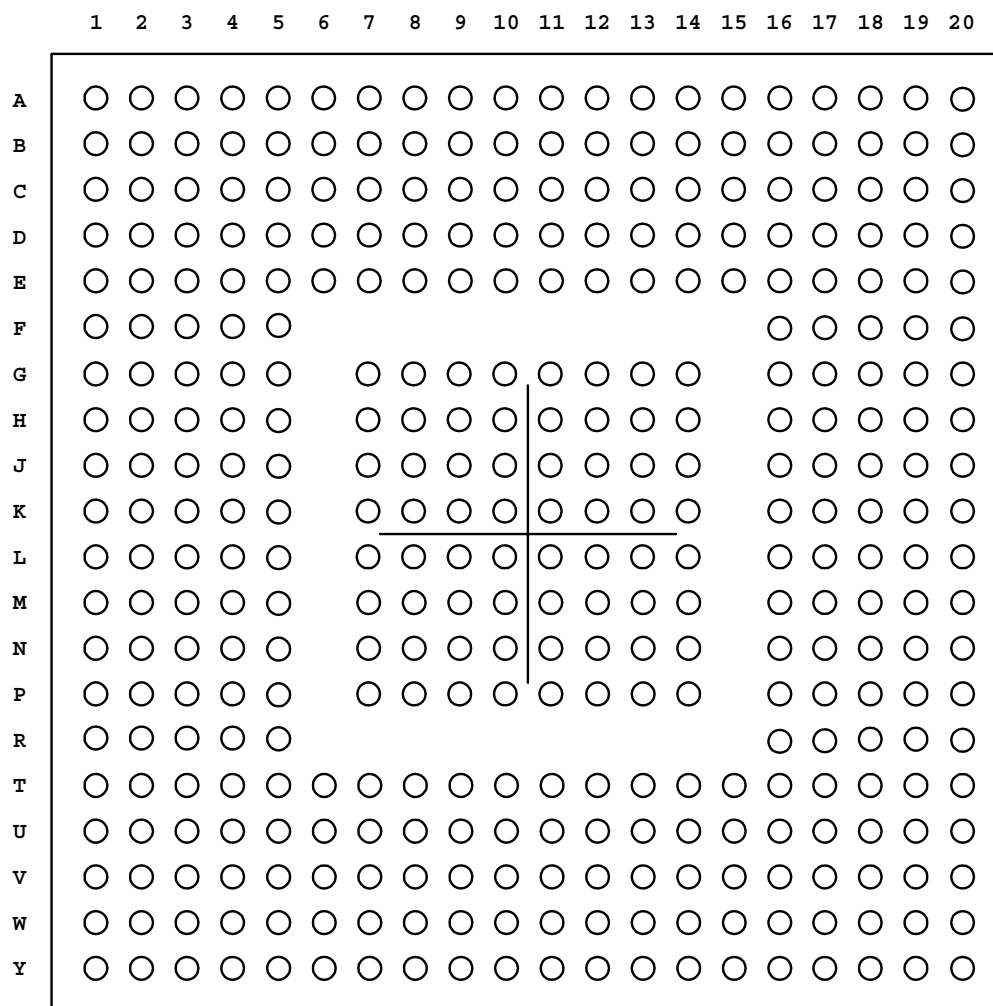

## 6.6 Pinout Information

**Table 25. PCI Address, Data, and Control Signals**

Signal	Pin	Signal	Pin	Signal	Pin
PCI_AD[0]	T14	PCI_AD[28]	Y3	PCI_AD[56}	T17
PCI_AD[1]	V14	PCI_AD[29]	U4	PCI_AD[57]	U18
PCI_AD[2]	Y15	PCI_AD[30]	V3	PCI_AD[58]	V18





**Table 25. PCI Address, Data, and Control Signals**

Signal	Pin	Signal	Pin	Signal	Pin
PCI_AD[3]	W14	PCI_AD[31]	V1	PCI_AD[59]	U16
PCI_AD[4]	T13	PCI_AD[32]	L16	PCI_AD[60]	V17
PCI_AD[5]	V13	PCI_AD[33]	M20	PCI_AD[61]	W18
PCI_AD[6]	Y14	PCI_AD[34]	M19	PCI_AD[62]	Y19
PCI_AD[7]	U12	PCI_AD[35]	M16	PCI_AD[63]	T16
PCI_AD[8]	V12	PCI_AD[36]	M18	CBE[0]#	Y13
PCI_AD[9]	T12	PCI_AD[37]	M17	CBE[1]#	V10
PCI_AD[10]	W12	PCI_AD[38]	N20	CBE[2]#	T8
PCI_AD[11]	Y12	PCI_AD[39]	N16	CBE[3]#	Y4
PCI_AD[12]	V11	PCI_AD[40]	P20	CBE[4]#	V16
PCI_AD[13]	T11	PCI_AD[41]	N18	CBE[5]#	Y18
PCI_AD[14]	Y11	PCI_AD[42]	P19	CBE[6]#	Y17
PCI_AD[15]	W10	PCI_AD[43]	P16	CBE[7]#	T15
PCI_AD[16]	U8	PCI_AD[44]	R20	PAR	U10
PCI_AD[17]	Y7	PCI_AD[45]	P18	PAR64	V15
PCI_AD[18]	Y6	PCI_AD[46]	P17	FRAME#	V8
PCI_AD[19]	V7	PCI_AD[47]	T20	IRDY#	W8
PCI_AD[20]	T7	PCI_AD[48]	R16	TRDY#	Y8
PCI_AD[21]	W6	PCI_AD[49]	U20	STOP#	V9
PCI_AD[22]	Y5	PCI_AD[50]	R18	IDSEL	T6
PCI_AD[23]	V6	PCI_AD[51]	T19	DEVSEL#	T9
PCI_AD[24]	U6	PCI_AD[52]	V20	VIO	Y1
PCI_AD[25]	V5	PCI_AD[53]	T18	VIO	Y20
PCI_AD[26]	W4	PCI_AD[54]	W20		
PCI_AD[27]	V4	PCI_AD[55]	V19		

**Table 26. PCI Arbitration Signals**

Signal	Pin	Signal	Pin	Signal	Pin
REQ64#	U14	REQ#	W2	LOCK#	Y9
ACK64#	W16	GNT#	T3		

**Table 27. Interrupt Signals**

Signal	Pin	Signal	Pin	Signal	Pin
INTA#	Y2				

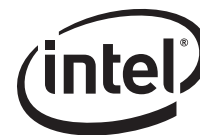
**Table 28. System Signals**

Signal	Pin	Signal	Pin	Signal	Pin
CLK	U2	M66EN	Y16	RST#	T5

**Table 29. Error Reporting Signals**

Signal	Pin	Signal	Pin	Signal	Pin
SERR#	T10	PERR#	Y10		

**Table 30. Power Management Signals**

Signal	Pin	Signal	Pin	Signal	Pin
LAN_PWR_GOOD	A17	PME#	T4	AUX_PWR	R3

**Table 31. Impedance Compensation Signals**

Signal	Pin	Signal	Pin	Signal	Pin
ZN_COMP	T2	ZP_COMP	R5		

**Table 32. SMB Signals**

Signal	Pin	Signal	Pin	Signal	Pin
SMBCLK	A14	SMBDATA	A15	SMBALRT#	A16

**Table 33. EEPROM Interface Signals**

Signal	Pin	Signal	Pin	Signal	Pin
EE_DI	C19	EE_CS	C20	EE_SK	D20
EE_DO	B20				

**Table 34. Flash Interface Signals**

Signal	Pin	Signal	Pin	Signal	Pin
FL_ADDR[0]	F16	FL_ADDR[10]	G17	FL_OE#	K18
FL_ADDR[1]	E18	FL_ADDR[11]	G16	FL_WE#	C17
FL_ADDR[2]	E16	FL_ADDR[12]	B15	FL_DATA[0]/LAN_DISABLE	H16
FL_ADDR[3]	E15	FL_ADDR[13]	D19	FL_DATA[1]	G18
FL_ADDR[4]	E14	FL_ADDR[14]	D18	FL_DATA[2]	J16
FL_ADDR[5]	E13	FL_ADDR[15]	C15	FL_DATA[3]	H18
FL_ADDR[6]	D15	FL_ADDR[16]	D16	FL_DATA[4]	J17



**Table 34. Flash Interface Signals**

Signal	Pin	Signal	Pin	Signal	Pin
FL_ADDR[7]	B16	FL_ADDR[17]	C18	FL_DATA[5]	J18
FL_ADDR[8]	F17	FL_ADDR[18]	D17	FL_DATA[6]	K17
FL_ADDR[9]	F18	FL_CS#	H20	FL_DATA[7]	K16

**Table 35. LED Signals**

Signal	Pin	Signal	Pin	Signal	Pin
ACT#	N1	LINK100#	N4	LINK1000#	N3
LINK#	M1				

**Table 36. Software Definable Signals**

Signal	Pin	Signal	Pin	Signal	Pin
SDP[0]	G4	SDP[6]	E12	SDP[7]	E11
SDP[1]	G5				

**Table 37. PHY Signals**

Signal	Pin	Signal	Pin	Signal	Pin
XTAL1	A3	MDI0+	B2	MDI2+	D2
XTAL2	A4	MDI1-	C1	MDI3-	E1
REF	E3	MDI1+	C2	MDI3+	E2
MDI0-	B1	MDI2-	D1		

**Table 38. Serializer/Deserializer (SERDES) Signals**

Signal	Pin	Signal	Pin	Signal	Pin
RX+	G19	TX+	F19	SIG_DETECT	E20
RX-	G20	TX-	F20		

**Table 39. Test Interface Signals**

Signal	Pin	Signal	Pin	Signal	Pin
JTAG_TCK	P1	JTAG_TMS	P5	CLK_VIEW	P3
JTAG_TDI	P4	JTAG_RST#	N5	TEST#	A8
JTAG_TDO	P2				



Table 40. Power Support Signals

Signal	Pin	Signal	Pin	Signal	Pin
CTRL_15	A18	CTRL_25	F2		

Table 41. Digital Power Signals

Signal	Pin	Signal	Pin	Signal	Pin
VDDO (3.3V)	B8	VDDO (3.3V)	U7	DVDD (1.5V)	H13
VDDO (3.3V)	B14	VDDO (3.3V)	U11	DVDD (1.5V)	H14
VDDO (3.3V)	B19	VDDO (3.3V)	U15	DVDD (1.5V)	J7
VDDO (3.3V)	C10	VDDO (3.3V)	U19	DVDD (1.5V)	J14
VDDO (3.3V)	C16	VDDO (3.3V)	W1	DVDD (1.5V)	M7
VDDO (3.3V)	D6	VDDO (3.3V)	W5	DVDD (1.5V)	M14
VDDO (3.3V)	D11	VDDO (3.3V)	W9	DVDD (1.5V)	N7
VDDO (3.3V)	E17	VDDO (3.3V)	W13	DVDD (1.5V)	N8
VDDO (3.3V)	H4	VDDO (3.3V)	W17	DVDD (1.5V)	N13
VDDO (3.3V)	H19	DVDD (1.5V)	G7	DVDD (1.5V)	N14
VDDO (3.3V)	L17	DVDD (1.5V)	G8	DVDD (1.5V)	P7
VDDO (3.3V)	M2	DVDD (1.5V)	G9	DVDD (1.5V)	P8
VDDO (3.3V)	N19	DVDD (1.5V)	G12	DVDD (1.5V)	P9
VDDO (3.3V)	R4	DVDD (1.5V)	G13	DVDD (1.5V)	P12
VDDO (3.3V)	R17	DVDD (1.5V)	G14	DVDD (1.5V)	P13
VDDO (3.3V)	U1	DVDD (1.5V)	H7	DVDD (1.5V)	P14
VDDO (3.3V)	U3	DVDD (1.5V)	H8		

Table 42. Analog Power Signals

Signal	Pin	Signal	Pin	Signal	Pin
AVDDH (3.3 V)	B4	AVDDL (2.5 V)	G1	AVDDL (2.5 V)	L2
AVDDH (3.3 V)	F1	AVDDL (2.5 V)	G2	AVDDL (2.5 V)	L5
AVDDL (2.5 V)	A19	AVDDL (2.5 V)	G3	AVDDL (2.5 V)	L18

Table 43. Grounds and No Connect Signals

Signal	Pin	Signal	Pin	Signal	Pin
GND	A1	GND	K12	NC	A13
GND	A2	GND	K13	NC	B12
GND	A5	GND	K14	NC	B13
GND	A10	GND	L7	NC	C12
GND	B3	GND	L8	GND	W15



**Table 43. Grounds and No Connect Signals**

Signal	Pin	Signal	Pin	Signal	Pin
GND	B6	GND	L9	GND	W19
GND	B11	GND	L10	NC	A11
GND	B17	GND	L11	NC	A12
GND	C3	GND	L12	NC	C13
GND	D3	GND	L13	NC	C14
GND	D8	GND	L14	NC	D12
GND	D14	GND	L19	NC	D13
GND	E19	GND	M4	NC	F4
GND	F3	GND	M8	NC	F5
GND	G10	GND	M9	NC	H1
GND	G11	GND	M10	NC	H3
GND	H2	GND	M11	NC	H5
GND	H9	GND	M12	NC	J1
GND	H10	GND	M13	NC	J2
GND	H11	GND	N9	NC	J3
GND	H12	GND	N10	NC	J4
GND	H17	GND	N11	NC	J5
GND	J8	GND	N12	NC	J19
GND	J9	GND	N17	NC	J20
GND	J10	GND	P10	NC	K1
GND	J11	GND	P11	NC	K3
GND	J12	GND	R2	NC	K19
GND	J13	GND	R19	NC	K20
GND	K2	GND	U5	NC	L1
GND	K4	GND	U9	NC	L3
GND	K5	GND	U13	NC	L4
GND	K7	GND	U17	NC	M3
GND	K8	GND	V2	NC	N2
GND	K9	GND	W3	NC	T1
GND	K10	GND	W7		
GND	K11	GND	W11		

**Table 44. Reserved Signals**

Signal	Pin	Signal	Pin	Signal	Pin
Reserved[0]	D4	Reserved[11]	B7	Reserved[22]	B10
Reserved[1]	D5	Reserved[12]	A7	Reserved[23]	C6
Reserved[2]	C4	Reserved[13]	C8	Reserved[24]	A20



Table 44. Reserved Signals

Signal	Pin	Signal	Pin	Signal	Pin
Reserved[3]	E4	Reserved[14]	E8	Reserved[25]	B18
Reserved[4]	C5	Reserved[15]	E9	Reserved[26]	M5
Reserved[5]	E5	Reserved[16]	D9	Reserved[27]	E7
Reserved[6]	B5	Reserved[17]	C9	Reserved[28]	A6
Reserved[7]	E6	Reserved[18]	B9	Reserved[29]	R1
Reserved[8]	D7	Reserved[19]	D10	Reserved[30]	L20
Reserved[9]	C7	Reserved[20]	A9		
Reserved[10]	E10	Reserved[21]	C11		

## X-ON Electronics

Largest Supplier of Electrical and Electronic Components

*Click to view similar products for [Ethernet ICs category](#):*

*Click to view products by [Intel manufacturer](#):*

Other Similar products are found below :

[EZFM6324A S LKA5](#) [EZFM6364A S LKA7](#) [12200BS23MM](#) [EZFM5224A S LKA3](#) [VSC8522XJQ-02](#) [WGI219LM SLKJ3](#) [EZFM6348A S LKA6](#) [WGI219V SLKJ5](#) [BCM84793A1KFSBG](#) [BCM56680B1KFSBLG](#) [BCM53402A0KFSBG](#) [BCM56960B1KFSBG](#) [EZX557AT2 S LKVX](#) [BCM56842A1KFTBG](#) [BCM56450B1KFSBG](#) [EZX557AT S LKW4](#) [LAN9254-I/JRX](#) [RTL8211FS-CG](#) [RTL8153-VC-CG](#) [CH395L KTI225IT S LNNK](#) [KTI225IT S LNNL](#) [VSC8562XKS-14](#) [BCM56864A1IFSBG](#) [KSZ8462FHLLI](#) [LAN9303MI-AKZE](#) [KSZ8841-16MVLI X550T2BLK](#) [KSZ8842-16MVLI](#) [KSZ8893MQL](#) [VSC8244XHG](#) [ADIN2111BCPZ](#) [ADIN2111CCPZ-R7](#) [FIDO2100BGA128IR0 FIDO5210CBCZ](#) [FIDO5210BBCZ](#) [FIDO5110CBCZ](#) [FIDO5200CBCZ](#) [ADIN1110BCPZ](#) [ADIN1110CCPZ](#) [ADIN1100BCPZ ADIN1110CCPZ-R7](#) [ADIN1100CCPZ-R7](#) [ADIN1110BCPZ-R7](#) [DM9000EP](#) [DM9161AEP](#) [HG82567LM S LAVY](#) [LAN9210-ABZJ LAN9221-ABZJ](#) [LAN9221I-ABZJ](#)