

# Intel<sup>®</sup> Integrated RAID Module RMS25PB080, RMS25PB040, RMS25CB080 and RMS25CB040 Hardware User's Guide

---

Intel Order Number: G37519-003

## DISCLAIMER

INFORMATION IN THIS DOCUMENT IS PROVIDED IN CONNECTION WITH INTEL® PRODUCTS. NO LICENSE, EXPRESS OR IMPLIED, BY ESTOPPEL OR OTHERWISE, TO ANY INTELLECTUAL PROPERTY RIGHTS IS GRANTED BY THIS DOCUMENT. EXCEPT AS PROVIDED IN INTEL'S TERMS AND CONDITIONS OF SALE FOR SUCH PRODUCTS, INTEL ASSUMES NO LIABILITY WHATSOEVER, AND INTEL DISCLAIMS ANY EXPRESS OR IMPLIED WARRANTY, RELATING TO SALE AND/OR USE OF INTEL PRODUCTS INCLUDING LIABILITY OR WARRANTIES RELATING TO FITNESS FOR A PARTICULAR PURPOSE, MERCHANTABILITY, OR INFRINGEMENT OF ANY PATENT, COPYRIGHT OR OTHER INTELLECTUAL PROPERTY RIGHT. Intel® products are not intended for use in medical, life saving, life sustaining applications. Intel® may make changes to specifications and product descriptions at any time, without notice.

Intel® is a trademark or registered trademark of Intel Corporation or its subsidiaries in the United States and other countries.

\*Other names and brands may be claimed as the property of others.

Copyright © 2012 by Intel Corporation. Portions Copyright © 2012 by LSI\* Corporation. All rights reserved.

# Preface

---

This is the primary hardware guide for the Intel® Integrated RAID Module RMS25PB080, RMS25PB040, RMS25CB080 and RMS25CB040, which can be used to manage SAS and SATA disk drives. It contains installation instructions and specifications.

For details on configuring the storage adapters, and for an overview of the software drivers, see the *Intel® RAID Software User's Guide* under the link for this Intel® Integrated RAID module at [http://www.intel.com/p/en\\_US/support/server](http://www.intel.com/p/en_US/support/server).

## Audience

This document assumes that you have some familiarity with RAID controllers/modules and related support devices. The people who benefit from this book are:

- Engineers who are planning to use an Intel® Integrated RAID Module RMS25PB080, RMS25PB040, RMS25CB080 or RMS25CB040 as a part of their RAID system.
- Anyone installing an Intel® Integrated RAID Module RMS25PB080, RMS25PB040, RMS25CB080 or RMS25CB040 in their RAID system.

## Organization

This document includes the following chapters and appendices:

- Chapter 1 provides a general overview of the Intel® Integrated RAID Module RMS25PB080, RMS25PB040, RMS25CB080 and RMS25CB040.
- Chapter 2 describes the procedures for installing and configuring the RAID modules.
- Chapter 3 provides the characteristics and technical specifications for the Intel® Integrated RAID Module RMS25PB080, RMS25PB040, RMS25CB080 or RMS25CB040.
- Appendix A explains drive roaming and drive migration.
- Appendix B provides safety instructions to be observed during installation and assembly.
- Appendix C provides regulatory and certification information.

## Related Publication

The *Intel® RAID Software User's Guide* is available under the link for this Intel® Integrated RAID module at [http://www.intel.com/p/en\\_US/support/server](http://www.intel.com/p/en_US/support/server).

# Table of Contents

---

<b>Preface</b> .....	<b>iii</b>
Audience .....	iii
Organization .....	iii
Related Publication .....	iv
<b>Chapter 1: Overview</b> .....	<b>1</b>
Benefits of SAS and SATA .....	1
Intel® Integrated RAID Module RMS25PB0x0 and RMS25CB0x0 .....	2
Protocol Support .....	2
Operating System Support .....	2
Usability .....	3
Redundancy and Error Handling .....	4
SAS/SATA Features .....	5
Online Capacity Expansion and RAID Level Migration Rules .....	5
Beep Codes .....	5
<b>Chapter 2: Intel® Integrated RAID Module RMS25PB0x0 and RMS25CB0x0 Hardware Installation</b> .....	<b>7</b>
Requirements .....	7
Installing the Intel® Integrated RAID Module RMS25PB0x0 .....	7
Installing the Intel® Integrated RAID Module RMS25CB0x0 .....	10
Configuring the RAID Module .....	13
Replacing a Module .....	13
Resolving a Config Mismatch .....	13
<b>Chapter 3: Intel® Integrated RAID Module RMS25PB0x0 and RMS25CB0x0 Characteristics</b> .....	<b>15</b>
Major Components .....	18
LSI* SAS2208 ROC .....	18
Flash ROM .....	19
Boot Strap ROM (SEEPROM) .....	19
NVSRAM .....	19
SDRAM (Cache) .....	19
Diagnostic Components .....	20
SAS/SATA Connectors .....	21
BBU/RMFBU Connector Pin-out .....	23
PCI Interface .....	24
Host Board Interface .....	25
Mechanical Overview .....	27
LED Headers .....	28

Technical Specifications .....	29
Array Performance Features .....	30
Fault Tolerance .....	31
Electrical Characteristics .....	32
Thermal and Atmospheric Characteristics .....	32
Safety Characteristics .....	33
Operating Certifications .....	33
Supported Device Technology .....	33
Support for Hard Disk Drive Devices .....	33
SAS Expander Support .....	33
Support for Non-Hard Disk Drive Devices .....	34
Enclosure Management Support .....	34
RAID Functionality and Features .....	34
Hierarchy .....	34
.....	35
<b>Appendix A: Drive Roaming and Drive Migration Install .....</b>	<b>37</b>
Drive Roaming .....	37
Drive Migration .....	38
<b>Appendix B: Installation/Assembly Safety Instructions .....</b>	<b>39</b>
English .....	41
Deutsch .....	42
Français .....	43
Español .....	45
Italiano .....	46
<b>Appendix C: Regulatory and Certification Information .....</b>	<b>49</b>
Product Safety and EMC Compliance .....	49

# List of Figures

---

Figure 1. Changing the Bracket.....	8
Figure 2. Installing the Intel® Integrated RAID Module RMS25PB0x0.....	8
Figure 3. Connecting Cable between the RAID Module and Drives/Backplane.....	9
Figure 4. Installing the Barrel Standoff.....	10
Figure 5. Installing the Intel® Integrated RAID Module RMS25CB0x0.....	11
Figure 6. Connecting Cable between the RAID Module and Drives/Backplane.....	12
Figure 7. RMS25PB0x0 Card Layout.....	15
Figure 8. RMS25CB0x0 Card Layout.....	16
Figure 9. Intel® Integrated RAID Module RMS25PB0x0 Hardware Block Diagram.....	17
Figure 10. Intel® Integrated RAID Module RMS25CB0x0 Hardware Block Diagram.....	18
Figure 11. Intel® RAID Smart Battery AXXRSBBU9.....	19
Figure 12. Intel® RAID Maintenance Free Backup Unit AXXRMFBU2.....	20
Figure 13. Internal SFF8087 SAS/SATA signal connectors.....	21
Figure 14. PCI Interface.....	25
Figure 15. Mechanical Drawing for Intel® Integrated RAID Module RMS25CB0x0.....	28
Figure 16. LED Header.....	29





# List of Tables

---

Table 1. RMS25PB0x0 Jumper Description .....	15
Table 2. RMS25CB0x0 Jumper Description .....	16
Table 3. SFF8087 Internal Connector with one SGPIO Connector Pin-out .....	22
Table 4. BBU/RMFBU Connector Pin-out .....	23
Table 5. Host Board Interface Connector Pin-Out .....	26
Table 6. LED Headers Pin-out .....	29
Table 7. Technical Specifications .....	29
Table 8. Array Performance Features .....	30
Table 9. Fault Tolerance Features .....	31
Table 10. Actual Power Consumption Table .....	32
Table 11. RAID Physical Drive Status .....	34
Table 12. RAID Virtual Drive Status .....	35



# 1 Overview

---

The Intel® Integrated RAID Module RMS25PB080, RMS25PB040, RMS25CB080 and RMS25CB040 are high-performance intelligent PCI Express\* 3.0 compliant SAS/SATA RAID controllers that offer reliability, high performance, and fault-tolerant disk subsystem management. This is an ideal RAID solution that meets the internal storage needs of workgroup, department, or enterprise systems to use with cost-effective SATA or high performance SAS media.

As second generation PCI Express\* storage controller, the Intel® Integrated RAID Module RMS25PB080, RMS25PB040, RMS25CB080 and RMS25CB040 address the growing demand for increased data throughput and scalability requirements across entry level, midrange, and enterprise server platforms.

The Intel® Integrated RAID Module RMS25PB080 and RMS25CB080 control 8 internal SAS/SATA ports through two SFF-8087 Mini SAS x4 internal connectors, and the Intel® Integrated RAID Module MS25PB040 and RMS25CB040 control 4 internal SAS/SATA ports through one SFF-8087 Mini SAS x4 internal connectors. For more information about the use of expanders, see the *ANSI SAS Standard, version 2.0 specification*.

SATA and SAS are serial, point-to-point, device interfaces that use simplified cabling, smaller connectors, lower pin counts, and lower power requirements than parallel SCSI.

The optional Intel® RAID Smart Battery AXXRSBBU9 or Intel® RAID Maintenance Free Backup Unit AXXRMFBU2 provides cached data protection for the RAID controller, even during system failures.

## Benefits of SAS and SATA

SAS is a serial, enterprise-level device interface that leverages the proven SCSI protocol set. SAS is a convergence of the advantages of SATA, SCSI, and FC, and is the future mainstay of the enterprise and high-end workstation storage markets. SAS offers a higher bandwidth per pin than parallel SCSI and improves signal and data integrity.

The SAS interface uses the proven SCSI command set to ensure reliable data transfers, while providing the connectivity and flexibility of point-to-point serial data transfers. The serial transmission of SCSI commands eliminates clock skew challenges. The SAS interface provides improved performance, simplified cabling, smaller connectors, lower pin count, and lower power requirements than parallel SCSI.

SAS controllers leverage a common electrical and physical connection interface that is compatible with Serial ATA technology. The SAS and SATA protocols use a thin, 7-wire connector instead of the 68-wire SCSI cable or 40-wire ATA cable. The SAS/SATA connector and cable are easier to manipulate, connect to smaller devices, and do not

inhibit airflow. The point-to-point SATA architecture eliminates difficulties created by the legacy ATA master-slave architecture, while maintaining compatibility with existing ATA firmware.

## Intel® Integrated RAID Module RMS25PB0x0 and RMS25CB0x0

The Intel® Integrated RAID Module RMS25PB080, RMS25PB040, RMS25CB080 and RMS25CB040 are intelligent RAID adapter with an integrated LSI SAS2208 dual-core RAID-On-Chip chipset, providing both a SAS controller and RAID engine. With 1GB RAM built onto the board and four independent ports (RMS25PB040 and RMS25CB040) or eight independent ports (RMS25PB080 and RMS25CB080) supporting 6Gb/s and 3Gb/s SAS data transfers using one or two SFF-8087 mini multi-lane connectors, the controllers support up to 128 enterprise-class SAS or SATA devices.

Intel® Integrated RAID Module RMS25PB080 and RMS25PB040 are custom low-profile RAID adapters and the PCI Express\* connector fits into an x8 or x16 PCI Express\* slot capable of performance up to 8 GT/s per lane.

Intel® Integrated RAID Module RMS25CB080 and RMS25CB040 are custom board-to-board PCI Express\* 3.0 compliant interface RAID adapters and the PCI Express\* connector fits into a 80 pin connector capable of performance up to 8 GT/s per lane.

The RAID modules are designed to fit various Intel® Server Boards and systems. For the most up-to-date support list, see the Compatibility section under the link for these Intel® Integrated RAID Modules at [http://www.intel.com/p/en\\_US/support/server](http://www.intel.com/p/en_US/support/server).

**Note:** *The modules will support PCI Express\* Revision 3.0 at post launch.*

## Protocol Support

Each port on the SAS controllers supports SAS devices, SATA devices, or both using SSP, SMP, STP, and SATA II as follows:

- Serial SCSI Protocol (SSP) to enable communication with other SAS devices.
- SATA II Protocol to enable communication with other SATA devices.
- SATA III Protocol to enable communication with other SATA III devices.
- Serial Management Protocol (SMP) to share topology management information with expanders.
- Serial Tunneling Protocol (STP) support for SATA II through expander interfaces.

## Operating System Support

- Windows Server 2008 R2\*, Windows 7\*, Windows Server 2003\*, Windows Vista\*

- Red Hat\* Enterprise Linux 5.0, and 6.0
- SuSE\* Linux Enterprise Server 10 and 11
- VMWare\* ESX 4.0
- Solaris\* 10

The operating systems supported may not be supported by your server board. See the *Tested operating system list* for your server board at <http://www.intel.com>.

To make sure the RAID module supports your operating system, see also the *Tested Hardware and Operating System List* for the Intel® Integrated RAID Module RMS25PB080, RMS25PB040, RMS25CB080 and RMS25CB040.

## Usability

- The the Intel® Integrated RAID Module RMS25PB080 and RMS25PB040 ship with both a standard and a low-profile bracket.
  - Small, thin cabling with serial point-to-point 6.0 Gbps data transfer rates.
  - Support for non-disk devices and mixed capacity drives.
  - Support for intelligent XOR RAID levels 0, 1, 5, 6, 10, 50, and 60.
  - Dedicated or global hot spare with auto rebuild if an array drive fails.
  - User defined stripe size per drive: 8, 16, 32, 64, 128, 256, 512, or 1024 KB.
  - Advanced array configuration and management utilities provide:
    - Online Capacity Expansion (OCE) adds space to existing drive or new drive. See [Appendix A: Drive Roaming and Drive Migration Install](#) for limitations on OCE and RAID migration.
    - Online RAID level migration (upgrade of RAID mode may require OCE)
    - Drive migration
    - Drive roaming
    - No reboot necessary after expansion
    - Load Balancing
  - Upgradeable Flash ROM interface.
  - Allows for staggered spin-up, hot-plug, and lower power consumption.
  - User specified rebuild rate (percent of system resources to use from 0-100%).
- Caution:** *Exceeding 50% rate may cause operating system errors due to waiting for controller access.*
- Background operating mode can be set for Rebuilds, Consistency Checks, Initialization (auto restarting Consistency Check on redundant volumes), Migration, OCE, and Patrol Read.

## Redundancy and Error Handling

- SGPIO enclosure management support
- Fault indicators per drive.
- Drive coercion (auto-resizing to match existing disks).
- Auto-detection of failed drives with transparent rebuild. There must be disk activity (I/O to the drive) for a missing drive to be marked as failed.
- Auto-resume of initialization or rebuild on reboot (the Auto Rebuild feature must be enabled before virtual disk creation).
- Smart initialization automatically checks consistency of virtual disks if there are five or more disks in a RAID 5 array, which optimizes performance by enabling read-modify-write mode. RAID 5 arrays of only three or four drives use Peer Read mode.
- Smart Technology predicts failures of drives and electronic components.
- Patrol Read checks drives and maps bad sectors.
- Commands are retried at least four times.
- Firmware provides best effort to recognize an error and recover if possible.
- Failures are logged from controller and drive firmware, and SMART monitor.
- Failures are logged in NVRAM, viewable from OS Event Log, Intel® RAID Web Console 2, CIM, and LEDs.
- Multiple cache options allow configuration-specific performance optimization:
  - Write-back: Faster because it does not wait for the disk but data will be lost if power is lost.
  - Write-through: Usually slower but ensures data is on the disk.
  - Read Ahead: Predicts next read will be sequential and buffers this data into the cache.
  - Non Read Ahead: Always reads from the drive after determining exact location of each read.
  - Adaptive Read Ahead: Reads ahead and caches data only if doing sequential reads.
  - I/O setting. Determines whether read operations check the cache before reading from disks.
    - ✧ Cache I/O: Checks cache first, only reads disk if data is not in the cache.
    - ✧ Direct I/O: Reads data directly from disk. (not cache)
- Redundancy through:
  - Configuration stored in non-volatile RAM and on the drives (COD).
  - Hot-swap support.
  - Optional battery backup or maintenance free backup for cache memory.

## SAS/SATA Features

- Provides eight independent phys, each supporting 6Gb/s and 3Gb/s SAS data transfers per PHY.
- Scalable interface that supports up to 128 physical devices through expanders.
- Supports SSP to enable communication with other SAS devices.
- Supports SMP to communicate topology management information.
- Supports single PHY or wide ports consisting of 2, 3, or 4 PHYs within a single quad port.
- Allows addressing of multiple SATA targets through an expander if using SATA 2.0-compliant hard disk drives.
- Allows multiple initiators to address a single target (in a fail-over configuration) through an expander.

## Online Capacity Expansion and RAID Level Migration Rules

- Migration must occur to the same or larger capacity configuration.
- Migration cannot occur if there is more than one virtual disk in a logical array.
- Migration and OCE cannot be done on Spanned Arrays (RAID 10, 50, and 60).
- Migrations supported are RAID 1 to RAID 0, RAID 5 to RAID 0, RAID 6 to RAID 0.
- With OCE, migrations supported are RAID 0 to RAID 1, RAID 0 to RAID 5, RAID 0 to RAID 6, RAID 1 to RAID 5, RAID 1 to RAID 6, RAID 5 to RAID 6.

## Beep Codes

- Short beep (1 second on, 1 second off): Array has degraded but no data has been lost.
- Long beep (3 seconds on, 1 second off): Array has failed and data has been lost.
- Short beep (1 second on, 3 seconds off): Using hot spare in rebuild; alarm will continue during rebuild with a different sound at completion.

To disable the alarm, choose Disable Alarm. To enable the alarm, choose Enable Alarm.

To disable the alarm only until the next event or until next power cycle, choose SilenceAlarm.





# 2 Intel® Integrated RAID Module RMS25PB0x0 and RMS25CB0x0 Hardware Installation

---

## Requirements

- Intel® Integrated RAID Module RMS25PB080, RMS25PB040, RMS25CB080 or RMS25CB040 (SAS/SATA cables need to be prepared separately).
- A supported host system with an available x8 or x16 PCI-Express\* slot for RMS25PB080 and RMS25PB040, or an available SAS Module Connector for RMS25CB080 and RMS25CB040.
- Resource CD, which contains drivers and documentation.
- SAS or SATA hard drives up to 6Gb/s speed.
- SAS/SATA cable accessory kit, which can be ordered from Intel separately. Please see the Tested Operating System List for available cable accessory kits at [http://www.intel.com/p/en\\_US/support/server](http://www.intel.com/p/en_US/support/server).

***Note:** Intel Corporation strongly recommends using an uninterruptible power supply (UPS). The Resource CD is shipped with systems or boards that support Intel® Integrated RAID Module RMS25PB080, RMS25PB040, RMS25CB080 or RMS25CB040.*

## Installing the Intel® Integrated RAID Module RMS25PB0x0

To install the RAID module, follow these steps:

1. Turn off the power to the system, all drives, enclosures, and system components. Remove the power cord(s).
2. Remove the server cover. For instructions, see your server system documentation.
3. If necessary, change the bracket on the RAID module to fit the height of the server system (see [Figure 1](#)).

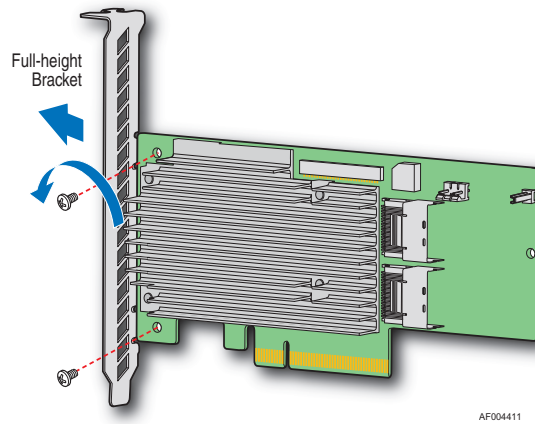

**Figure 1. Changing the Bracket**

4. Install the RAID module into an available server system x8 or x16 PCI-Express\* slot (see [Figure 2](#)). To locate an appropriate slot and for instructions on installing an add-in card, see your server system documentation.

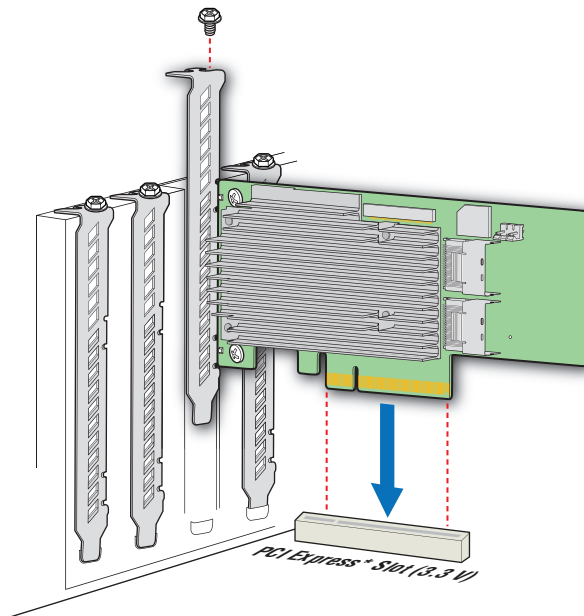

AF004412

**Figure 2. Installing the Intel® Integrated RAID Module RMS25PB0x0**

5. Connect the proper cables into the adapter using the 4-port combined end. Make sure the module and cables are properly attached and plug the cable into connector at the inside edge of the adapter.

**Note:** To prevent throughput problems:

- ✧ Use the cables provided or use the shortest possible cable.
- ✧ Do not use cables longer than one meter.
- ✧ Decrease the maximum length by one foot if you are using a backplane.
- ✧ Do not use cross-over cables.
- ✧ Only connect to a SATA drive, SAS or SATA backplane, or an expander device.
- ✧ Route the cables carefully.
- ✧ Check that the module and cables are all properly attached.

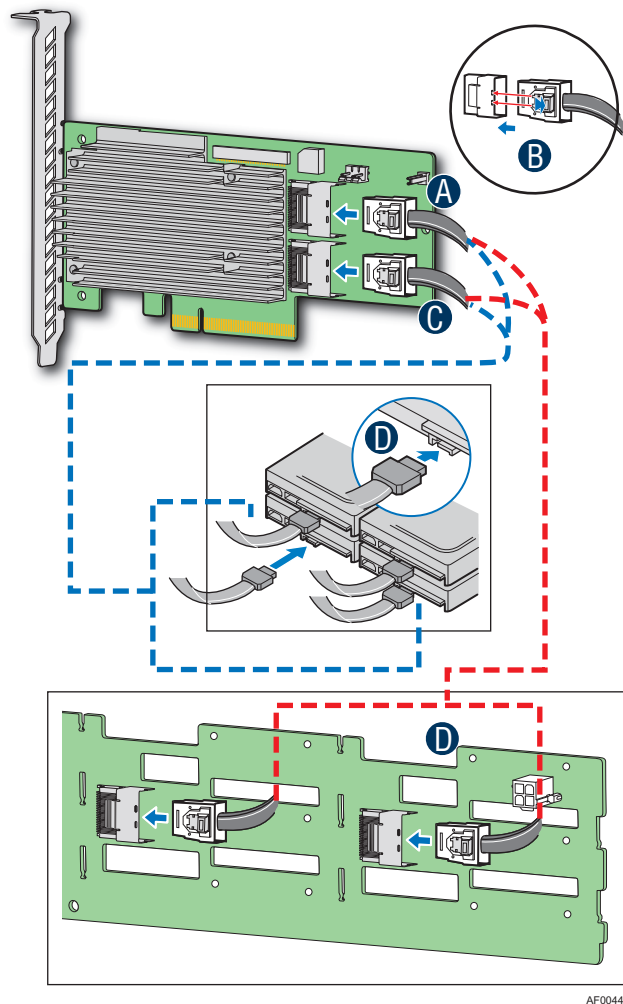

**Figure 3. Connecting Cable between the RAID Module and Drives/Backplane**

6. Install the server system cover and connect the power cords. See your server system documentation for instructions.

## Installing the Intel<sup>®</sup> Integrated RAID Module RMS25CB0x0

To install the RAID module, follow these steps:

1. Turn off the power to the system, all drives, enclosures, and system components. Remove the power cord(s).
2. Remove the server cover. For instructions, see your server system documentation.
3. Insert the four barrel standoffs into the matching holes in the server board. To locate the matching module card slot on your server board, see your server board documentation. The Intel<sup>®</sup> Server Board S2600IP is shown for illustrative purpose. Actual standoff hole locations could be different (see [Figure 1](#)).

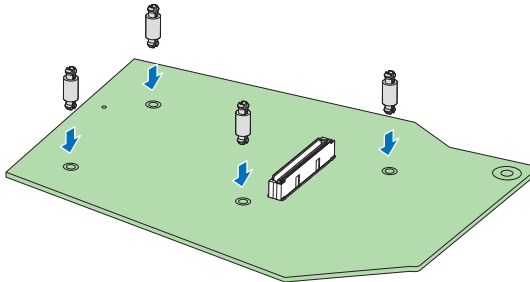

AF004406

**Figure 4. Installing the Barrel Standoff**

4. Attach the RAID to the matching server board connector, and press the module card firmly to engage the barrel standoffs installed in step 3 (see [Figure 3](#)). Press down gently but firmly to ensure that the card is properly seated in the connectors, and then insert the four pin standoffs into the barrel standoffs respectively. The Intel<sup>®</sup> RAID Module RMS25CB080 is shown for illustrative purpose (see [Figure 5](#)).

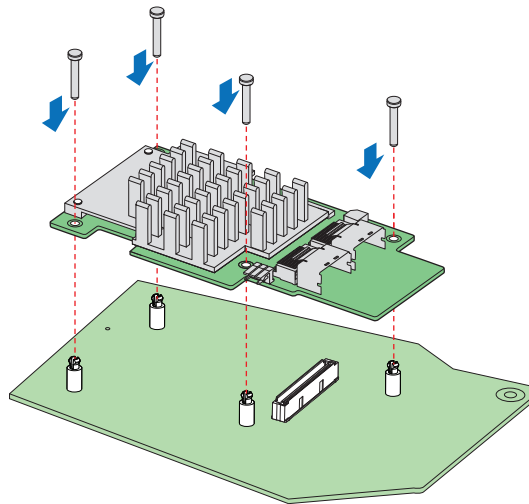
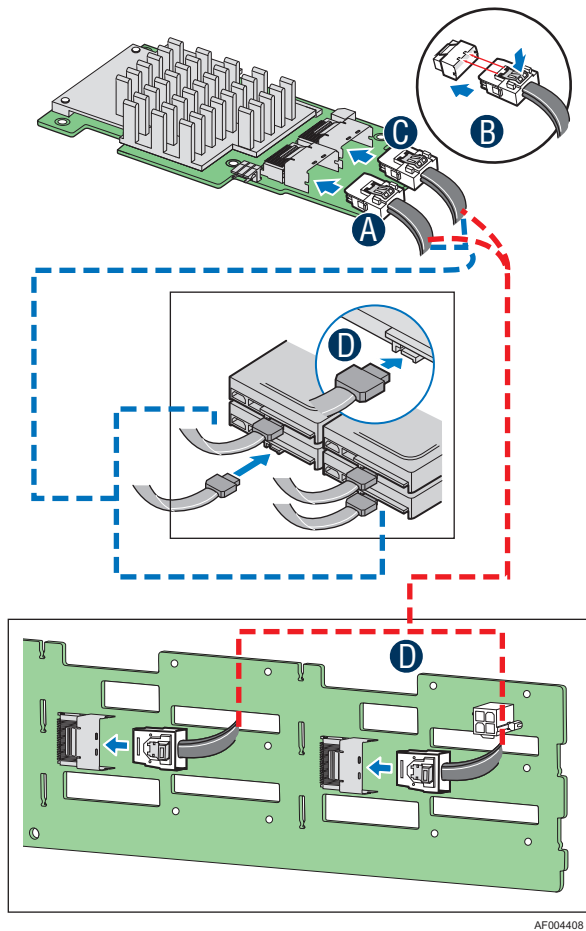

**Figure 5. Installing the Intel® Integrated RAID Module RMS25CB0x0**

5. Connect the proper cables into the adapter using the 4-port combined end. Make sure the module and cables are properly attached and plug the cable into connector at the inside edge of the adapter.

**Note:** To prevent throughput problems:

- ✧ Use the cables provided or use the shortest possible cable.
- ✧ Do not use cables longer than one meter.
- ✧ Decrease the maximum length by one foot if you are using a backplane.
- ✧ Do not use cross-over cables.
- ✧ Only connect to a SATA drive, SAS or SATA backplane, or an expander device.
- ✧ Route the cables carefully.
- ✧ Check that the module and cables are all properly attached.



**Figure 6. Connecting Cable between the RAID Module and Drives/Backplane**

6. Install the server system cover and connect the power cords. See your server system documentation for instructions.

## Configuring the RAID Module

To configure the RAID module, follow these steps:

1. Turn on the system power and check to make sure that the SAS/SATA devices power up before or at the same time as the system.
2. During the boot, the following BIOS message appears to state the keys that you need to press to enter the Intel<sup>®</sup> RAID BIOS Console 2, such as:  
`Press <CTRL><G> to run BIOS Console 2.`  
This message times out after several seconds. If you miss it, you need to restart the system.  
After you press the keys to enter the Intel<sup>®</sup> RAID BIOS Console 2 software, the firmware takes several seconds to initialize and then display the Intel<sup>®</sup> Integrated Module number and firmware version. The numbering of the RAID module follows the PCI slot scanning order used by the server board.
3. Follow the instructions in the *Intel<sup>®</sup> RAID Software User's Guide* (Document Number: D29305-0xx) to configure the RAID module and to install the operating system drivers.

## Replacing a Module

To replace the RAID module, see your server system documentation for instructions to remove and then install an add-in adapter.

## Resolving a Config Mismatch

If the newly installed RAID module was previously configured, a message displays during POST, stating that there is a configuration mismatch because the configuration data in the NVRAM differs from that in the hard drives. Use these steps to resolve the mismatch:

1. Press <Ctrl> + <G> when prompted during boot up to access the BIOS Configuration Utility
2. Select Configure > View/Add Configuration to see the NVRAM and drive configurations.
3. If the drives contain the correct configuration, use configuration from the disks.
4. Press <Esc> and select YES to update the NVRAM.
5. Exit and reboot.





# 3 Intel® Integrated RAID Module RMS25PB0x0 and RMS25CB0x0 Characteristics

---

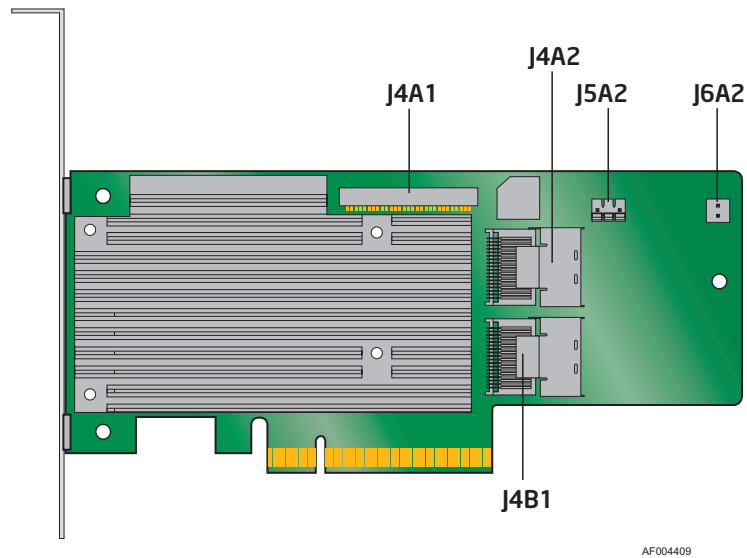
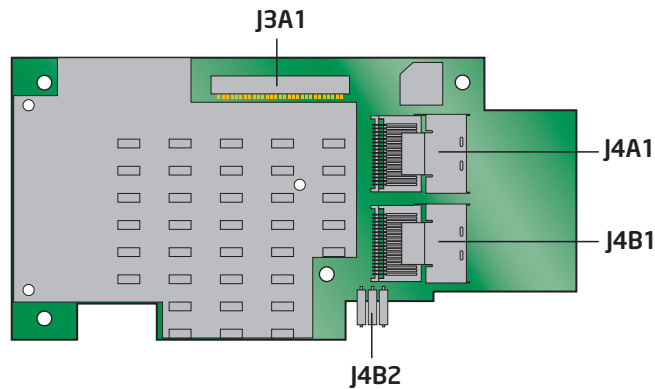

**Figure 7. RMS25PB0x0 Card Layout**

**Table 1. RMS25PB0x0 Jumper Description**

<b>Jumper/ Connector</b>	<b>Type</b>	<b>Description</b>
J4A1	Board-to-board connector for Battery Backup Unit	30-pin connector Provides an interface to the daughter card that contains the battery backup unit.
J6A2	Activity LED header	2-pin connector Connects to an LED that indicates activity on the drives connected to the controller.

Jumper/ Connector	Type	Description
J4B1	x4 SAS Ports 4-7 internal connector	SFF-8087 mini SAS 4i internal connector. Connects the controller by cable to SAS/SATA devices. J4B1 (Ports 4-7) is only available on Intel® Integrated Module RMS25PB080.
J4A2	x4 SAS Ports 0-3 internal connector	SFF-8087 mini SAS 4i internal connector. Connects the controller by cable to SAS/SATA devices.
J5A2	Advanced Software Hardware Key Header	3-pin header Enables support for selected advanced features, such as recovery, Supersized cache, FastPath, and full disk encryption.



AF004410

**Figure 8. RMS25CB0x0 Card Layout**

**Table 2. RMS25CB0x0 Jumper Description**

Jumper/ Connector	Type	Description
J3A1	Board-to-board connector for Battery Backup Unit	30-pin connector Provides an interface to the daughter card that contains the battery backup unit.
J4B1	x4 SAS Ports 4-7 internal connector	SFF-8087 mini SAS 4i internal connector. Connects the controller by cable to SAS/SATA devices. J4B1 (Ports 4-7) is only available on Intel® Integrated Module RMS25CB080.

Jumper/Connector	Type	Description
J4A1	x4 SAS Ports 0-3 internal connector	SFF-8087 mini SAS 4i internal connector. Connects the controller by cable to SAS/SATA devices.
J4B2	Advanced Software Hardware Key Header	3-pin header Enables support for selected advanced features, such as recovery, Supersized cache, FastPath, and full disk encryption.

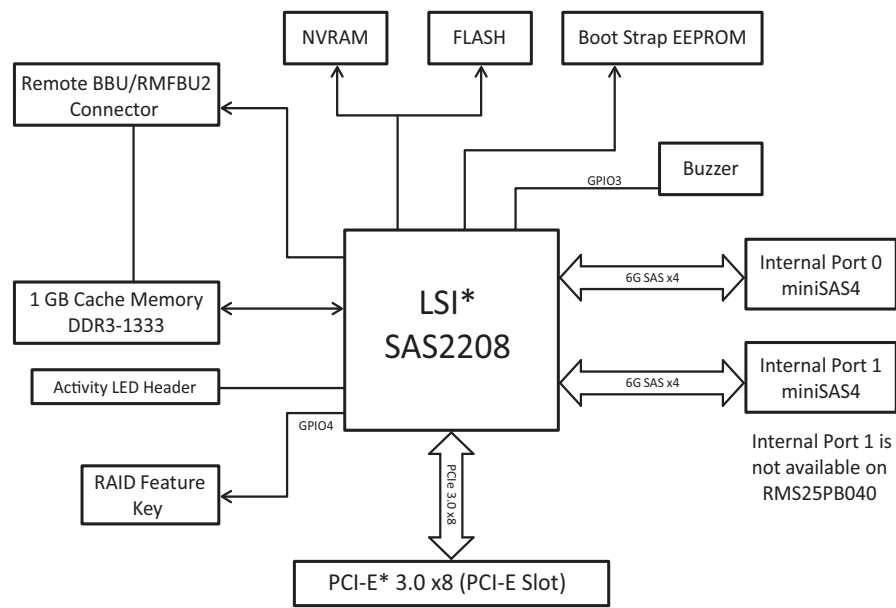

**Figure 9. Intel® Integrated RAID Module RMS25PB0x0 Hardware Block Diagram**

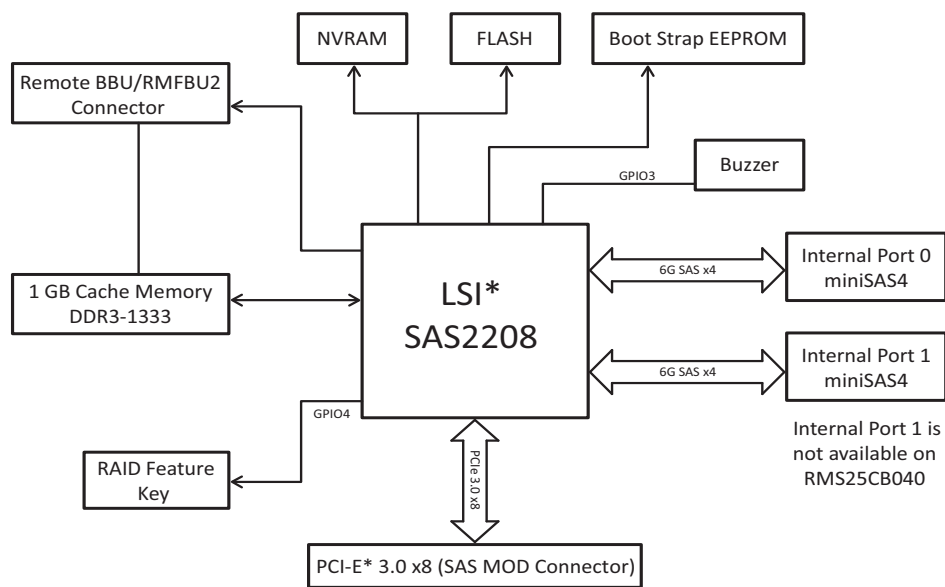

**Figure 10. Intel® Integrated RAID Module RMS25CB0x0 Hardware Block Diagram**

## Major Components

### LSI\* SAS2208 ROC

The LSI\* SAS2208 dual-core RAID-On-Chip (ROC) is an integrated SAS and I/O controller operating at 800 MHz. For more information, see <http://www.lsi.com>. The LSI\* SAS2208 dual-core ROC provides the following functions:

- x8 PCI Express\* bus operating at 6.0 Gbps serial transfer rate
- Spread Spectrum Clocking (SSC)
- SAS/SMP/STP/SATA support
- Supports SAS and SATA devices
- Initiator and Target mode (SSP)
- Wide port support
- T10 End-to-End Data Protection (EEDP)
- Local 72-bit DDR3 SDRAM interface with ECC checking
- Fusion MPT message unit
- PCI Express\* interface supports x8, x4, and x1 lane configurations

## Flash ROM

An 16-MB CFI-compliant flash ROM is used to accommodate RAID firmware and RAID BIOS Console 2 OpROM.

## Boot Strap ROM (SEEPROM)

The serial bootstrap ROM is used to configure the LSI\* SAS2208 ROC before the server board configures the PCI Express\* registers. The bootstrap ROM sets the Phase Lock Loop (PLL) dividers, bootstrap configuration, and so on.

## NVSRAM

A 128-KB NVSRAM is used to store disk and drive setup information.

## SDRAM (Cache)

The Intel® Integrated RAID Module RMS25PB080, RMS25PB040, RMS25CB080 and RMS25CB040 include 1 GB of integrated DDR3 1333 MHz ECC SDRAM memory. This DIMM is connected directly to the memory controller interface bus of the ROC and serves as storage for the executable code transferred from the flash. It also serves as cache during RAID transactions. Cache mode selection takes immediate effect while the server is online and is available on a per virtual drive basis. The ROC memory controller provides single-bit ECC error correction with multi-bit detection support.

The Intel® Integrated RAID Module RMS25PB080, RMS25PB040, RMS25CB080 and RMS25CB040 support Intel® RAID Smart Battery AXXRSBBU9 and Intel® RAID Maintenance Free Backup Unit AXXRMFBU2.

The optional Intel® RAID Smart Battery AXXRSBBU9 provides a battery backup option for data cached in the memory. It is connected remotely to the RAID module through a supplied cable. See the figure below (for reference only). Actual shape of the product may vary from the figure.



**Figure 11. Intel® RAID Smart Battery AXXRSBBU9**

The optional Intel® RAID Maintenance Free Backup Unit AXRMFBU2 provides another backup option for data cached in the memory by offloading data stored in the RAM cache to the NAND flash if there is a complete AC power failure or a brief power outage. It is connected remotely to the RAID module through a supplied cable. See the figure below (for reference only). Actual shape of the product may vary from the figure.

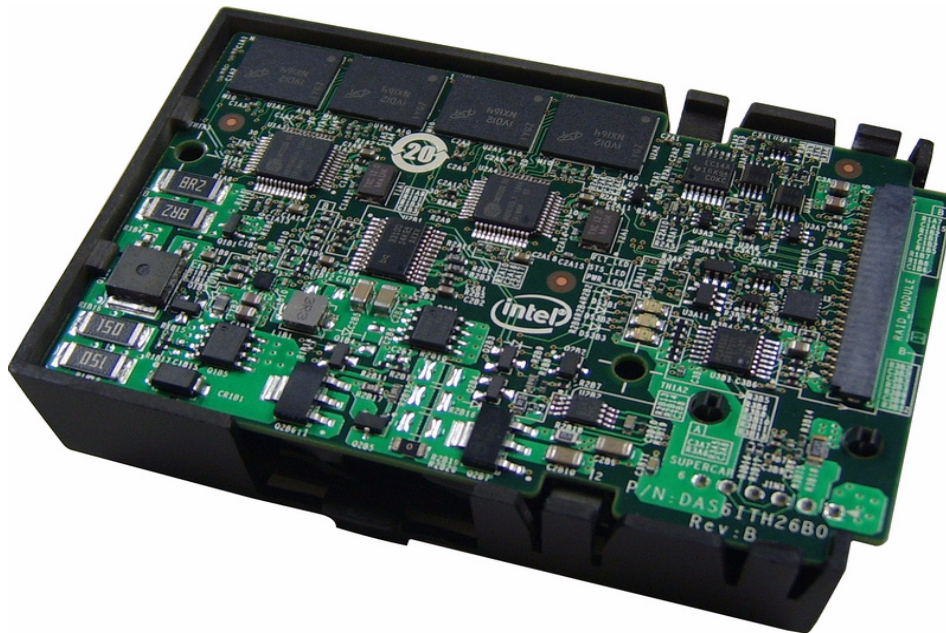

**Figure 12. Intel® RAID Maintenance Free Backup Unit AXRMFBU2**

*Note:* Intel Corporation strongly recommends using an uninterruptible power supply (UPS).

## Diagnostic Components

### Audible Alarm

The audible alarm beeps when a drive fails and also during a rebuild. The drive failure alarm beeps are:

- Degraded array: Short tone, one second on, one second off.
- Failed array: Long tone, three seconds on, one second off.
- Hot spare commissioned: Short tone, one second on, three seconds off.

The drive failure tones repeat until the problem is corrected, or until the alarm is silenced or disabled. The alarm can be silenced or disabled on the controller's properties page in the BIOS Console or by using the failed drive options pane in the Intel® RAID Web Console 2.

Silencing the alarm is temporary. If the cause of failure still exists or if an additional failure is detected, then the alarm sounds again when the system is rebooted. Disabling the alarm is persistent across errors and reboots. When the alarm is disabled, a failure does not cause it to sound until it is re-enabled.

The rebuild alarm tone functions differently. It remains ON during the rebuild. After the rebuild completes, an alarm with a different tone sounds to signal that the rebuild is complete. This is a one-time, non-repeating tone.

## LED Placement and Function

The Intel® Integrated RAID Module RMS25PB080, RMS25PB040, RMS25CB080 and RMS25CB040 contain the following LEDs:

- One surface-mounted heartbeat LED (Green Color) to indicate SAS2208 activity.
- Another two surface-mounted system error LEDs (Amber Color) to indicate a board error.

## SAS/SATA Connectors

The Intel® Integrated RAID Module RMS25PB080 and RMS25CB080 provide two internal SFF8087 SAS/SATA signal connectors. The Intel® Integrated RAID Module RMS25PB040 and RMS25CB040 provide one internal SFF8087 SAS/SATA signal connector. Each SFF8087 connector provides support for four SAS/SATA ports. The sideband signals are configured to adhere to the SFF-8485 Specifications for SGPIO support.

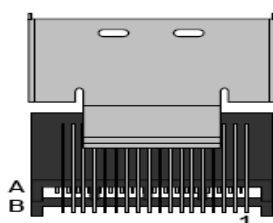

**Internal connector**

**Figure 13. Internal SFF8087 SAS/SATA signal connectors**

## SAS/SATA Connector Pin-out

Signal names are with respect to the host; the device connected to the host reverses the signal names. Transmit pins connect to receive pins on the other device. The SAS/SATA connector is keyed at pin 1. These pin-outs for the serial ATA connector are not compatible with the legacy PATA connector.

**Table 3. SFF8087 Internal Connector with one SGPIO Connector Pin-out**

Controller Connector Pin-out		Backplane Connector Pin-out		Port
SFF-8087 Pin #	Pin Definition	Pin #	Pin Definition	
A1	GND	7	GND	Port 0
A2	RX0+	6	TX+	
A3	RX0-	5	TX-	
B1	GND	4	GND	
B2	TX0+	2	RX+	
B3	TX0-	3	RX-	
B4	GND	1	GND	
A4	GND	7	GND	Port 1
A5	RX1+	6	TX+	
A6	RX1-	5	TX-	
A7	GND	4	GND	
B5	TX1+	2	RX+	
B6	TX1-	3	RX-	
B7	GND	1	GND	
B8	SB0/SCLK/SCL	1	SCLK	SGPIO
B9	SB1/SLOAD/SDA	2	SLOAD	
B10	SB2/GND	4	GND	
A9	SB3/GND			
A10	SB4/SDATA_OUT/RS T	3	SDATAOUT0	
A11	SB5/SDATA_IN/ADD R			
A8	SB7/BP_TYPE			
B11	SB6/CTLR_TYPE			



Controller Connector Pin-out		Backplane Connector Pin-out		Port
SFF-8087 Pin #	Pin Definition	Pin #	Pin Definition	
A12	GND	7	GND	Port 2
A13	RX2+	6	TX+	
A14	RX2-	5	TX-	
B12	GND	4	GND	
B13	TX2+	2	RX+	
B14	TX2-	3	RX-	
B15	GND	1	GND	
A15	GND	7	GND	Port 3
A16	RX3+	6	TX+	
A17	RX3-	5	TX-	
A18	GND	4	GND	
B16	TX3+	2	RX+	
B17	TX3-	3	RX-	
B18	GND	1	GND	

**Note:** The RAID controller in this document doesn't ship with SAS/SATA cables. Users can separately order the SAS/SATA cable accessory kit as needed. Please see the Tested Operating System List for available cable accessory kits at [http://www.intel.com/p/en\\_US/support/server/](http://www.intel.com/p/en_US/support/server/).

## BBU/RMFBU Connector Pin-out

**Table 4. BBU/RMFBU Connector Pin-out**

Pin #	Name	Description
1	BBU_INPLACE1_N	BBU plug-in confirmation 1
2	P12V	12V Power
3	P12V	12V Power
4	GND	Ground
5	PWRGD_P1V5	1.5V VR power good
6	GND	Ground
7	P3V3_AUX	3.3V auxiliary power

Pin #	Name	Description
8	P1V5_BB	1.5V battery power
9	GND	Ground
10	P3V3	3.3V power
11	P3V3	3.3V power
12	SMB_CLK_BBU_P3V3	Battery SMBus Clock
13	SMB_DAT_BBU_P3V3	Battery SMBus Data
14	BBU_STB_P3V3	3.3V auxiliary Battery power
15	BBU_EN_P3V3	Battery Backup Enabled
16	BBU_PFAIL_N	Battery Backup Power Fail
17	BBU_STATUS_P3V3	Battery Backup Status
18	RST_PF_PULSE_N	Reset
19	FM_SCAP_FAULT	Supper cap failure report
20	IRQ_HOST_PFAIL_N	Host failure report
21	FM_PDOK_R_N	Power Down OK to cache module
22	USB2_P0_DP	USB port0
23	USB2_P0_DN	USB port0
24	USB2_P1_DP	USB port1
25	USB2_P1_DN	USB port1
26	P1V8	1.8V power
27	PWRGD_P1V8	1.8V power good
28	RST_MASK	Reset mask
29	PWRGD_SYS	System power good
30	BBU_INPLACE2_N	BBU plug-in confirmation 2

## PCI Interface

Intel® Integrated RAID Module RMS25PB080 and RMS25PB040 must be installed into a standard x8 or larger PCI Express\* slot that complies with the PCI Express Specification, Revision 3.0. The controller is PCI Express\* 1.0 and 2.0 compatible and is backward-compatible with x8 or larger slots that are wired with x1, x2, and x4 PCI Express\* lanes.

**Note:** *The modules will support PCI Express\* Revision 3.0 at post launch.*

## Host Board Interface

Intel® Integrated RAID Module RMS25CB080 and RMS25CB0400 board interface with the host system through one custom board-to-board interface that implements one x8 PCI Express\* lanes signaling as defined in the *PCI Express Specification 3.0*. These interfaces also provide +3.3 V power to the board.

**Note:** The modules will support PCI Express\* Revision 3.0 at post launch.

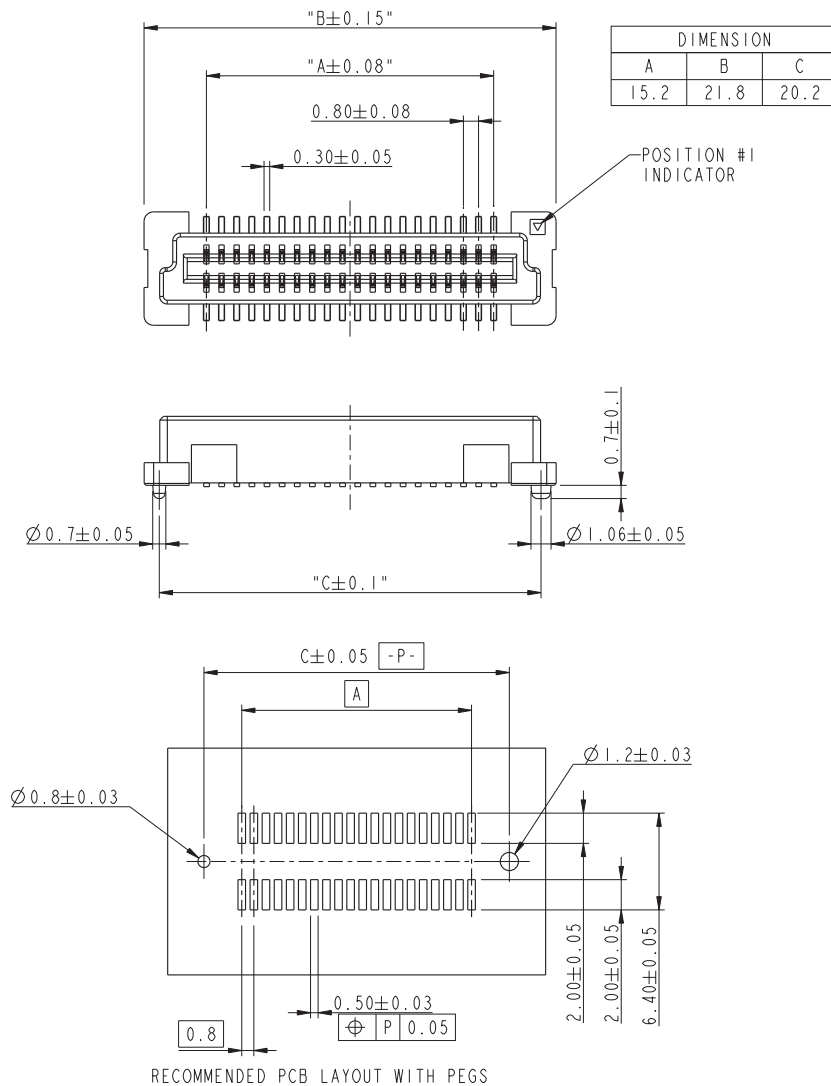

AF004606

**Figure 14. PCI Interface**

**Table 5. Host Board Interface Connector Pin-Out**

<b>Pin #</b>	<b>Description</b>	<b>Pin #</b>	<b>Description</b>
1	RSVD_SE	2	GND
3	GND	4	PCIe Gen3 Rp [0]
5	PCIe Gen3 Tp [0]	6	PCIe Gen3 Rn [0]
7	PCIe Gen3 Tn [0]	8	GND
9	GND	10	PCIe Gen3 Rp [1]
11	PCIe Gen3 Tp [1]	12	PCIe Gen3 Rn [1]
13	PCIe Gen3 Tn [1]	14	GND
15	GND	16	PCIe Gen3 Rp [2]
17	PCIe Gen3 Tp [2]	18	PCIe Gen3 Rn [2]
19	PCIe Gen3 Tn [2]	20	GND
21	GND	22	PCIe Gen3 Rp [3]
23	PCIe Gen3 Tp [3]	24	PCIe Gen3 Rn [3]
25	PCIe Gen3 Tn [3]	26	GND
27	GND	28	PCIe Gen3 Rp [4]
29	PCIe Gen3 Tp [4]	30	PCIe Gen3 Rn [4]
31	PCIe Gen3 Tn [4]	32	GND
33	GND	34	PCIe Gen3 Rp [5]
35	PCIe Gen3 Tp [5]	36	PCIe Gen3 Rn [5]
37	PCIe Gen3 Tn [5]	38	GND
39	GND	40	PCIe Gen3 Rp [6]
41	PCIe Gen3 Tp [6]	42	PCIe Gen3 Rn [6]
43	PCIe Gen3 Tn [6]	44	GND

Pin #	Description	Pin #	Description
45	GND	46	PCIe Gen3 Rp [7]
47	PCIe Gen3 Tp [7]	48	PCIe Gen3 Rn [7]
49	PCIe Gen3 Tn [7]]	50	GND
51	GND	52	rSASm REFCLK- [0]
53	SMB DAT	54	rSASm REFCLK+ [0]
55	SMB CLK	56	GND
57	GND	58	PERST#
59	RSVD_DN	60	WAKE#
61	RSVD_DP	62	FM_rINTm_PRESENT_N
63	GND	64	LED_HDD_N
65	RSVD_DN	66	3.3VSTBY
67	RSVD_DP	68	FM_rINTm_MODULE_EN
69	GND	70	5VSB
71	RSVD_SE	72	FRU/TEMP ADDR [A0]
73	3.3V	74	12V
75	3.3V	76	12V
77	3.3V	78	12V
79	3.3V	80	12V

## Mechanical Overview

The following figures display the Intel® Integrated RAID Module RMS25CB040 and RMS25CB080 dimensions.

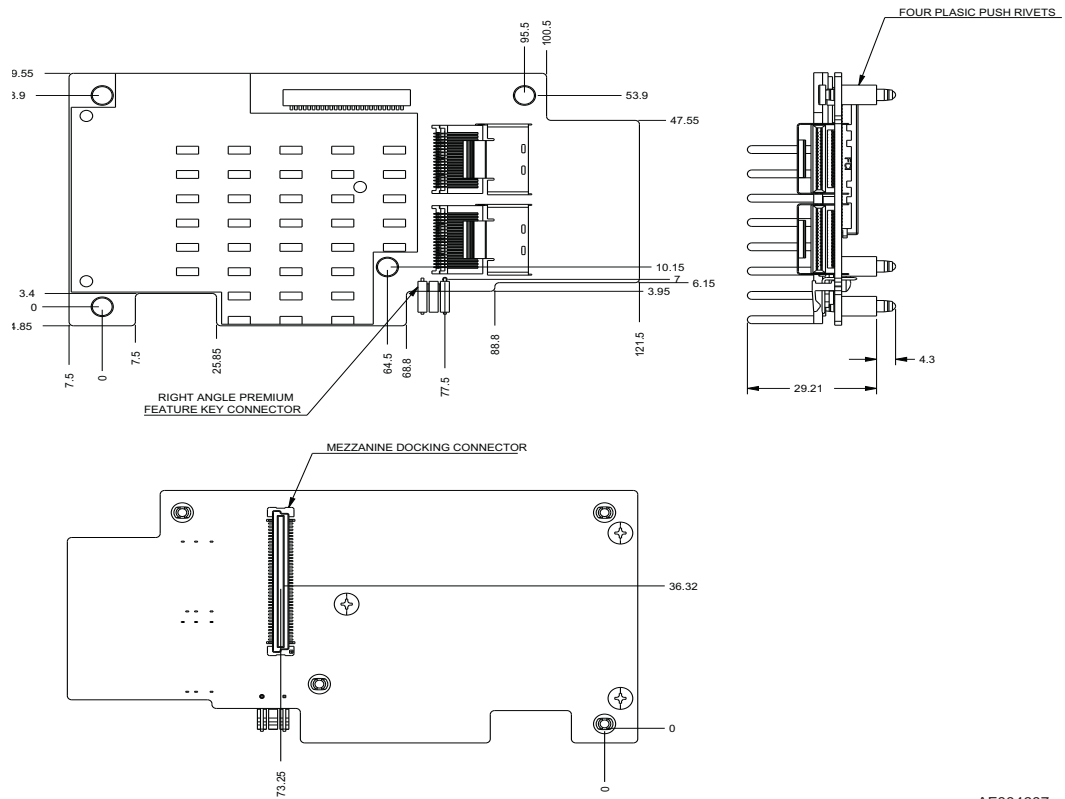

AF004607

**Figure 15. Mechanical Drawing for Intel® Integrated RAID Module RMS25CB0x0**

## LED Headers

There is one 2-pin header present on the RMS25PB080 and RMS25PB040 board and this header is used for connecting the external LED which indicates activity on any of the connected HDDs.

**Table 6. LED Headers Pin-out**

HDD Activity Header (J1A4)		
Pin #	Name	Description
1	D_ACTIVE_PU	330V to P3V3_DUAL
2	D_ACTIVE_N	Connected to Drain of onboard MFT

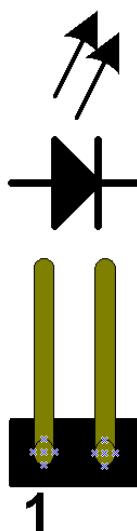

**Figure 16. LED Header**

## Technical Specifications

**Table 7. Technical Specifications**

Specification	Intel® Integrated RAID Module RMS25PB080, RMS25PB040, RMS25CB080 and RMS25CB040
RAID-on-Chip (ROC)	LSISAS2208 Integrated ROC, 800 MHz
Operating voltage	+3.3 V, +12 V
Card size	<b>RMS25PB040 and RMS25PB080:</b> 2.713 inch x 6.600 inch (Low-profile) <b>RMS25CB040 and RMS25CB080:</b> See Intel® Integrated RAID Module RMS25CB0x0 Mechanical overview
Array interface to host	<b>Note:</b> PCI Express* Revision 3.0 will be supported at post launch.

<b>Specification</b>	<b>Intel® Integrated RAID Module RMS25PB080, RMS25PB040, RMS25CB080 and RMS25CB040</b>
SAS/SATA bus speed	Up to 6 Gbps per port, point-to-point
SAS/SATA ports	<ul style="list-style-type: none"> <li>• 2x4 internal port (RMS25PB080 and RMS25CB080)</li> <li>• 1x4 internal port (RMS25PB040 and RMS25CB040)</li> </ul>
Physical and virtual drive support	128 physical drives, 64 virtual drives, and 32 RAID arrays per controller
Cache	1 GB DDR3 1333 MHz SDRAM, optional battery backup
Firmware	16 MB in reflashable flash ROM
Compatible devices	<ul style="list-style-type: none"> <li>• 2.5-inch and 3.5-inch SAS 2.0 or SATA III</li> <li>• Non disk devices including expanders</li> <li>• Can support drives of mixed capacity</li> </ul>
Cabling	<ul style="list-style-type: none"> <li>• Small, thin cables that do not restrict airflow</li> <li>• Shared connectors for multiple drives</li> </ul>
Redundant configuration	128 KB NVRAM and config-on-disk (COD)
Enclosure management	SGPIO
Enclosure support	Assumes one SEP per enclosure

## Array Performance Features

**Table 8. Array Performance Features**

<b>Specification</b>	<b>Intel® Integrated RAID Module RMS25PB080, RMS25PB040, RMS25CB080 and RMS25CB040</b>
Host data transfer rate	Up to 8.0 Gigatransfer/sec per PCI Express* lane
Drive data transfer rate	Up to 6.0 Gigabit/sec per PHY
Maximum scatter/gather	80 elements
Maximum size of I/O requests	6.4 Mbytes in 64 Kbyte stripes
Maximum queue tags per drive	As many as the drive can accept
Stripe sizes	8, 16, 32, 64, 128, 256, 512, or 1024 KB



<b>Specification</b>	<b>Intel® Integrated RAID Module RMS25PB080, RMS25PB040, RMS25CB080 and RMS25CB040</b>
Maximum concurrent commands	255
Support for multiple initiators	Yes
Performance	Native command queuing
Flexibility	<ul style="list-style-type: none"> <li>• Drive migration</li> <li>• RAID level migration</li> <li>• Drive Roaming</li> <li>• Online Capacity Expansion - without reboot</li> </ul>
Background services	<ul style="list-style-type: none"> <li>• Rebuild</li> <li>• Consistency Check</li> <li>• Migration</li> <li>• OCE</li> <li>• Patrol Read</li> </ul>
Cache options	<ul style="list-style-type: none"> <li>• Write-back or Write-through</li> <li>• Read Ahead</li> <li>• Adaptive Read Ahead</li> <li>• Non Read Ahead</li> <li>• Cache I/O or Direct I/O</li> <li>• Disk Cache</li> </ul>

## Fault Tolerance

**Table 9. Fault Tolerance Features**

<b>Specification</b>	<b>Intel® Integrated RAID Module RMS25PB080, RMS25PB040, RMS25CB080 and RMS25CB040</b>
Self Monitoring Analysis and Reporting Technology (SMART) support	<ul style="list-style-type: none"> <li>• Detects up to 70% of predictable disk drive failures</li> <li>• Monitors the internal performance of all motors, heads, and drive electronics</li> </ul>
Optional Cache Memory Backup	<ul style="list-style-type: none"> <li>• Intel® RAID Smart Battery AXXR SBBU9 cache backup up to 48 hours of data retention, 'Gas Gauge'</li> <li>• Intel® RAID Maintenance Free Backup Unit AXXR MFBU2</li> </ul>
Drive Replacement	<ul style="list-style-type: none"> <li>• Auto detection of failure</li> <li>• Hot-plug</li> <li>• Hot-swap</li> </ul>
Drive Rebuild Using Hot Spares	<ul style="list-style-type: none"> <li>• Automatic at fail</li> <li>• Dedicated per Array</li> <li>• Global for any array</li> <li>• Auto-resume of initialization or rebuild on reboot</li> </ul>

Specification	Intel® Integrated RAID Module RMS25PB080, RMS25PB040, RMS25CB080 and RMS25CB040
Error Checking and Indication	<ul style="list-style-type: none"> <li>• Parity generation and checking, automatic consistency checking</li> <li>• Patrol reads</li> <li>• Activity and fault LEDs</li> <li>• Multiple retries</li> <li>• Logs in NVRAM, event log, CIM, Smart, Intel® RAID Web Console 2</li> </ul>

## Electrical Characteristics

All power is supplied to the adapter via the PCI Express 3.3V and 12V rail. Necessary Voltages are provided by onboard switching regulator circuitry operating off of 12V and 3.3V rails.

The following states determine the typical current consumption of the board:

- State 1. During BBU fast charge
- State 2. During initialization of all RAID 5 logical drives simultaneously
- State 3. While sitting idle at the DOS prompt.
  - Supply voltage = 12V +/- 8% (from PCI edge connector only)
  - Supply voltage = 3.3V +/- 9% (from PCI edge connector only)
  - Actual power consumption.

**Table 10. Actual Power Consumption Table**

PCI Edge connector	State1	State 2	State 3
3.3V supply	0.96A	0.86A	0.92A
+12V supply	0.81A	0.55A	0.56A
3.3V AUX. supply (BBU Applications only)	0.38A	0.2A	0.02A

**Note:** +12V is used in the charging circuitry for the battery pack on the optional BBU Remote card. If the BBU remote card is cable connected the following power consumption figures apply:

1. During trickle charging of the battery pack: N/A (no trickle charge for Li-ION)
2. During fast charging of the battery pack: 250mA rise in +12V current

## Thermal and Atmospheric Characteristics

The maximum board temperature is limited by the LSI SAS2208 ROC Processor since it uses the most power and will be the hottest component on the board.

- SAS2208 maximum junction temperature: 115°C
- Ambient temperature: maximum 60°C (without optional BBU)
- Maximum 45°C (with optional BBU)
- Airflow over SAS2208: 200 ft/min
- Environmental humidity: 20% to 80% non-condensing
- MTBF: greater than 250,000 hours

## Safety Characteristics

The bare PC board shall meet or exceed the requirements of UL flammability rating V0. The bare PC board shall also be marked with the supplier's name or trademark, type, and UL flammability rating. The maximum electrical potential on the board will be 12.96V potential difference, referenced from ground to +12V.

## Operating Certifications

The RAID modules in this document are qualified to get Microsoft Windows Winqual\* certification (WHQL) at product launch.

## Supported Device Technology

The various device technologies supported by the Intel® Integrated RAID Module RMS25PB080, RMS25PB040, RMS25CB080 and RMS25CB040 is described in the subsections that follow.

## Support for Hard Disk Drive Devices

Intel® Integrated RAID Module RMS25PB080, RMS25PB040, RMS25CB080 and RMS25CB040 integrates four or eight internal high-performance SAS/SATA III ports that support SAS and enterprise-class SATA hard drives. Each port supports both SAS and SATA devices using the SAS Serial SCSI Protocol (SSP), Serial Management Protocol (SMP), and Serial Tunneling Protocol (STP). The SSP protocol enables communication with other SAS devices. STP allows the SAS RAID controller to communicate with SATA devices using the SATA commands.

## SAS Expander Support

The Intel® Integrated RAID Module RMS25PB080, RMS25PB040, RMS25CB080 and RMS25CB040 supports LSI\* expanders, Vitesse\* SAS expanders, and PMC expanders that are used as a component in Intel® and third party enclosures. Other expanders may be supported post launch, based on market conditions and customer requirements.

## Support for Non-Hard Disk Drive Devices

Selected non-hard drive devices are supported for use with this module. For information on support for non-hard drive devices, see this RAID module's Tested Hardware and Operating System List.

## Enclosure Management Support

The Intel® Integrated RAID Module RMS25PB080, RMS25PB040, RMS25CB080 and RMS25CB040 support the internal SAS sideband signal SFF-8485 (SGPIO) enclosure management interface.

## RAID Functionality and Features

### Hierarchy

The fundamental purpose of a RAID system is to present a usable data storage medium (virtual drive) with some level of redundancy to a host operating system. The Intel® RAID firmware is based on the concept of associating physical drives in arrays and then creating a virtual drive from that array that includes a functional RAID level. To create a virtual drive and present it to the host operating system, the RAID firmware typically follows these steps:

1. One or more physical drives are selected and associated as an array.
2. One or more arrays are associated and given a RAID level. This process creates a virtual drive and provides an option to initialize the virtual drive.
3. The RAID firmware presents the virtual drive to the operating system.

### RAID Physical Drive Status

**Table 11. RAID Physical Drive Status**

Drive State	Code	Description
Unconfigured Good	Unconfigured Good	The drive is functioning normally, but is not part of a configured virtual drive and is not a hot spare.
Online	ONLN	The drive is online, is part of a configured virtual drive, and is functioning normally.
Hot Spare	HOTSP	A physical drive that is configured as a hot spare.
Failed	FAILED	A physical drive that was originally configured as Online or Hot Spare, but on which the firmware detects an unrecoverable error.

<b>Drive State</b>	<b>Code</b>	<b>Description</b>
Rebuilding	REBUILD	A physical drive to which data is being written to restore full redundancy for a virtual drive.
Unconfigured Bad	Unconfigured Bad	A physical drive on which the firmware detects an unrecoverable error; the physical drive was Unconfigured Good or the physical drive could not be initialized.
Missing	Missing	A physical drive that was online, but which has been removed from its location.
Offline	Offline	A physical drive that is part of a virtual drive but which has invalid data as far as the RAID configuration is concerned.
None	None	A physical drive with an unsupported flag set. An Unconfigured Good or Offline physical drive that has completed the 'prepare for removal' operation.

## RAID Virtual Drive Status

**Table 12. RAID Virtual Drive Status**

<b>Drive State</b>	<b>Code</b>	<b>Description</b>
Optimal	Optimal	The drive operating system is good. All configured drives are online.
Degraded	Degraded	The drive operating condition is not optimal because one of the configured drives has failed or is offline.
Offline	Offline	The drive is not available to the operating system and is unusable.

## RAID Controller Drive Limitations

Only drives that comply with the SAS and SATA specification extensions are supported.



# Appendix A: Drive Roaming and Drive Migration Install

---

## Drive Roaming

Drive roaming occurs when the hard drives are changed to different ports on the same controller. When the drives are placed on different ports, the controller detects the RAID configuration from the configuration data on the drives.

**Note:** *If you move a drive that is currently being rebuilt, the rebuild operation will restart, not resume.*

To use drive roaming, follow these steps:

1. Turn off the power to the system, all drives, enclosures, and system components. Remove the power cord(s).
2. Remove the server cover. For instructions, see your server system documentation.
3. Move the drives to different positions on the backplane to change the targets. See your server documentation for instructions to install and remove drives.
4. Determine the target requirements.
5. Make sure the drives are inserted properly.
6. Install the server cover. For instructions, see your server system documentation.
7. Plug in and power on the system.

The controller detects the RAID configuration from the configuration data on the drives (COD).

# Drive Migration

Drive migration moves a configured set of hard drives from one controller to another. The drives must remain on the same port and be reinstalled in the same order as in the original configuration. The controller to which you migrate the drives cannot have an existing configuration.

**Note:** *Only complete configurations can be migrated; individual virtual disks cannot be migrated. Drive roaming and drive migration cannot be supported at the same time.*

To migrate drives, follow these steps:

1. Clear the configuration on the system to which you migrate the drives.  
This prevents a configuration data mismatch between the hard drives and the NVRAM.
2. Turn off the power to the system, all drives, enclosures, and system components. Remove the power cord(s).
3. Remove the server cover. For instructions, see your server system documentation.
4. Disconnect the cables from the drives to be migrated.
5. Remove the hard drives from the first system and install them into the second system. For instructions to install and remove drives, see your server documentation.
6. Connect the data cables to the hard drives in the second system in the same order as they were connected in the first system. Make sure all the cables meet specifications.
7. Determine the drive target requirements.
8. Make sure all cables are properly attached and the RAID controller is properly installed.
9. Install the server cover. For instructions, see your server system documentation.
10. Plug in and power on the system.

When you start the system, the controller detects the RAID configuration from the configuration data on the drives.



# Appendix B: Installation/Assembly Safety Instructions

---

## **As you use your computer system, observe these safety guidelines:**

- Do not operate your computer system with any cover(s) (such as computer covers, bezels, filler brackets, and front-panel inserts) removed.
- To help avoid damaging your computer, be sure the voltage selection switch on the power supply is set to match the alternating current (AC) power available at your location.
- To help avoid possible damage to the server board, wait five seconds after turning off the system before removing a component from the server board or disconnecting a peripheral device from the computer.
- To help prevent electric shock, plug the computer and peripheral power cables into properly grounded power sources. These cables are equipped with 3-prong plugs to ensure proper grounding. Do not use adapter plugs or remove the grounding prong from a cable. If you must use an extension cable, use a 3-wire cable with properly grounded plugs.
- To help protect your computer system from sudden, transient increases and decreases in electrical power, use a surge suppressor, line conditioner, or uninterruptible power supply.
- Be sure nothing rests on your computer system's cables and that the cables are not located where they can be stepped on or tripped over.
- Do not spill food or liquids on your computer. If the computer gets wet, consult the documentation that came with it.
- Do not push any objects into the openings of your computer. Doing so can cause fire or electric shock by shorting out interior components.
- Keep your computer away from radiators and heat sources. Also, do not block cooling vents. Avoid placing loose papers underneath your computer; do not place your computer in a closed-in wall unit or on a rug.

## **When working inside your computer:**

- Do not attempt to service the computer system yourself, except as explained in this guide and elsewhere in Intel® documentation. Always follow installation and service instructions closely.
- Turn off your computer and any peripherals.
- Disconnect your computer and peripherals from their power sources. Also disconnect any telephone or telecommunications lines from the computer.

Doing so reduces the potential for personal injury or shock.

**Additional safety guidelines:**



- When you disconnect a cable, pull on its connector or on its strain-relief loop, not on the cable itself. Some cables have a connector with locking tabs; if you are disconnecting this type of cable, press in on the locking tabs before disconnect the cable. As you pull connectors apart, keep them evenly aligned to avoid bending any connector pins. Also, before you connect a cable, make sure both connectors are correctly oriented and aligned.
- Handle components and cards with care. Do not touch the components or contacts on a card. Hold a card by its edges or by its metal mounting bracket. Hold a component such as a microprocessor chip by its edges, not by its pins.

**Protecting against electrostatic discharge**

- Static electricity can harm delicate components inside your computer. To prevent static damage, discharge static electricity from your body before you touch any of your computer's electronic components, such as the microprocessor. You can do so by touching an unpainted metal surface, such as the metal around the card-slot openings at the back of the computer.
- As you continue to work inside the computer, periodically touch an unpainted metal surface to remove any static charge your body may have accumulated. In addition to the preceding precautions, you can also take the following steps to prevent damage from electrostatic discharge (ESD).
- When unpacking a static-sensitive component from its shipping carton, do not remove the component from the antistatic packing material until you are ready to install the component in your computer. Just before unwrapping the antistatic packaging, be sure to discharge static electricity from your body.
- When transporting a sensitive component, first place it in an antistatic container or packaging.
- Handle all sensitive components in a static-safe area. If possible, use antistatic floor pads and workbench pads.

# English

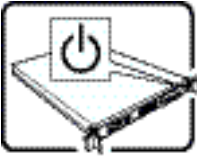
Read all caution and safety statements in this document before performing any of the instructions. See also *Intel® Server Boards and Server Chassis Safety Information* on the Resource CD and/or at <http://www.intel.com/support/motherboards/server/sb/cs-010770.htm>.

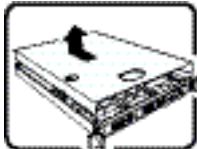
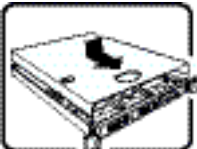
	<p>The power button on the system does not turn off system AC power. To remove AC power from the system, you must unplug each AC power cord from the wall outlet or power supply.</p> <p>The power cord(s) is considered the disconnect device to the main (AC) power. The socket outlet that the system plugs into shall be installed near the equipment and shall be easily accessible.</p>
	<p><b>SAFETY STEPS:</b> Whenever you remove the chassis covers to access the inside of the system, follow these steps:</p> <ol style="list-style-type: none"><li>1. Turn off all peripheral devices connected to the system.</li><li>2. Turn off the system by pressing the power button.</li><li>3. Unplug all AC power cords from the system or from wall outlets.</li><li>4. Label and disconnect all cables connected to I/O connectors or ports on the back of the system.</li><li>5. Provide some electrostatic discharge (ESD) protection by wearing an antistatic wrist strap attached to chassis ground of the system-any unpainted metal surface-when handling components.</li><li>6. Do not operate the system with the chassis covers removed.</li></ol>
	<p>After you have completed the six SAFETY steps above, you can remove the system covers. To do this:</p> <ol style="list-style-type: none"><li>1. Unlock and remove the padlock from the back of the system if a padlock has been installed.</li><li>2. Remove and save all screws from the covers.</li><li>3. Remove the cover(s).</li></ol>
	<p>For proper cooling and airflow, always reinstall the chassis covers before turning on the system. Operating the system without the covers in place can damage system parts. To install the covers:</p> <ol style="list-style-type: none"><li>1. Check first to make sure you have not left loose tools or parts inside the system.</li><li>2. Check that cables, add-in cards, and other components are properly installed.</li><li>3. Attach the covers to the chassis with the screws removed earlier, and tighten them firmly.</li><li>4. Insert and lock the padlock to the system to prevent unauthorized access inside the system.</li><li>5. Connect all external cables and the AC power cord(s) to the system.</li></ol>

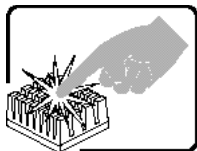

A microprocessor and heat sink may be hot if the system has been running. Also, there may be sharp pins and edges on some board and chassis parts. Contact should be made with care. Consider wearing protective gloves.

## Deutsch

Lesen Sie zunächst sämtliche Warn- und Sicherheitshinweise in diesem Dokument, bevor Sie eine der Anweisungen ausführen. Beachten Sie hierzu auch die *Sicherheitshinweise zu Intel®-Serverplatinen und -Servergehäusen* auf der Ressourcen-CD oder unter <http://www.intel.com/support/motherboards/server/sb/cs-010770.htm>.



Der Wechselstrom des Systems wird durch den Ein-/Aus-Schalter für Gleichstrom nicht ausgeschaltet. Ziehen Sie jedes Wechselstrom-Netzkabel aus der Steckdose bzw. dem Netzgerät, um den Stromanschluß des Systems zu unterbrechen.

Die Stromkabel sind das "Unterbrechungsgerät" zur Hauptstromquelle. Die Steckdose, in die das System gesteckt wird, sollte sich in der Nähe des Gerätes befinden und leicht zugänglich sein.



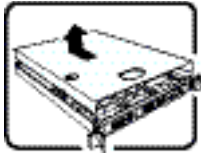
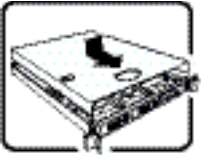
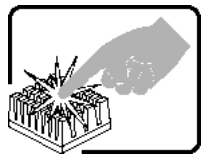

**SICHERHEITSMASSNAHMEN:** Immer wenn Sie die Gehäuseabdeckung abnehmen um an das Systeminnere zu gelangen, sollten Sie folgende Schritte beachten:

1. Schalten Sie alle an Ihr System angeschlossenen Peripheriegeräte aus.
2. Schalten Sie das System mit dem Hauptschalter aus.
3. Ziehen Sie den Stromanschlußstecker Ihres Systems aus der Steckdose.
4. Auf der Rückseite des Systems beschrifteten und ziehen Sie alle Anschlußkabel von den I/O Anschlüssen oder Ports ab.
5. Tragen Sie ein geerdetes Antistatik Gelenkband, um elektrostatische Ladungen (ESD) über blanke Metallstellen bei der Handhabung der Komponenten zu vermeiden.
6. Schalten Sie das System niemals ohne ordnungsgemäß montiertes Gehäuse ein.

	<p>SICHERHEITSMASSNAHMEN: Immer wenn Sie die Gehäuseabdeckung abnehmen um an das Systeminnere zu gelangen, sollten Sie folgende Schritte beachten:</p> <ol style="list-style-type: none"> <li>1. Schalten Sie alle an Ihr System angeschlossenen Peripheriegeräte aus.</li> <li>2. Schalten Sie das System mit dem Hauptschalter aus.</li> <li>3. Ziehen Sie den Stromanschlußstecker Ihres Systems aus der Steckdose.</li> <li>4. Auf der Rückseite des Systems beschriften und ziehen Sie alle Anschlußkabel von den I/O Anschlüssen oder Ports ab.</li> <li>5. Tragen Sie ein geerdetes Antistatik Gelenkband, um elektrostatische Ladungen (ESD) über blanke Metallstellen bei der Handhabung der Komponenten zu vermeiden.</li> <li>6. Schalten Sie das System niemals ohne ordnungsgemäß montiertes Gehäuse ein.</li> </ol>
	<p>Zur ordnungsgemäßen Kühlung und Lüftung muß die Gehäuseabdeckung immer wieder vor dem Einschalten installiert werden. Ein Betrieb des Systems ohne angebrachte Abdeckung kann Ihrem System oder Teile darin beschädigen. Um die Abdeckung wieder anzubringen:</p> <ol style="list-style-type: none"> <li>1. Vergewissern Sie sich, daß Sie keine Werkzeuge oder Teile im Innern des Systems zurückgelassen haben.</li> <li>2. Überprüfen Sie alle Kabel, Zusatzkarten und andere Komponenten auf ordnungsgemäßen Sitz und Installation.</li> <li>3. Bringen Sie die Abdeckungen wieder am Gehäuse an, indem Sie die zuvor gelösten Schrauben wieder anbringen. Ziehen Sie diese gut an.</li> <li>4. Bringen Sie die Verschlusseinrichtung (Padlock) wieder an und schließen Sie diese, um ein unerlaubtes Öffnen des Systems zu verhindern.</li> <li>5. Schließen Sie alle externen Kabel und den AC Stromanschlußstecker Ihres Systems wieder an.</li> </ol>
	<p>Der Mikroprozessor und der Kühler sind möglicherweise erhitzt, wenn das System in Betrieb ist. Außerdem können einige Platinen und Gehäuseteile scharfe Spitzen und Kanten aufweisen. Arbeiten an Platinen und Gehäuse sollten vorsichtig ausgeführt werden. Sie sollten Schutzhandschuhe tragen.</p>

## Français

Lisez attention toutes les consignes de sécurité et les mises en garde indiquées dans ce document avant de suivre toute instruction. Consultez *Intel® Server Boards and Server Chassis Safety Information* sur le CD Resource CD ou bien rendez-vous sur le site <http://www.intel.com/support/motherboards/server/sb/cs-010770.htm>.

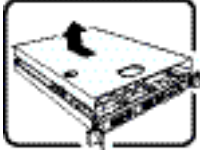
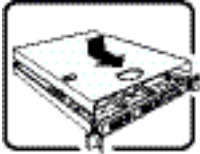
	<p>Notez que le commutateur CC de mise sous tension /hors tension du panneau avant n'éteint pas l'alimentation CA du système. Pour mettre le système hors tension, vous devez débrancher chaque câble d'alimentation de sa prise.</p> <p>C'est le câble d'alimentation qui est considéré comme le moyen de se déconnecter du CA. La prise à laquelle le système est branché doit se situer à proximité de l'équipement et être facilement accessible.</p>
	<p><b>CONSIGNES DE SÉCURITÉ</b> -Lorsque vous ouvrez le boîtier pour accéder à l'intérieur du système, suivez les consignes suivantes:</p> <ol style="list-style-type: none"> <li>1. Mettez hors tension tous les périphériques connectés au système.</li> <li>2. Mettez le système hors tension en mettant l'interrupteur général en position OFF (bouton-poussoir).</li> <li>3. Débranchez tous les cordons d'alimentation c.a. du système et des prises murales.</li> <li>4. Identifiez et débranchez tous les câbles reliés aux connecteurs d'E-S ou aux accès derrière le système.</li> <li>5. Pour prévenir les décharges électrostatiques lorsque vous touchez aux composants, portez une bande antistatique pour poignet et reliez-la à la masse du système (toute surface métallique non peinte du boîtier).</li> <li>6. Ne faites pas fonctionner le système tandis que le boîtier est ouvert.</li> </ol>
	<p>Une fois TOUTES les étapes précédentes accomplies, vous pouvez retirer les panneaux du système. Procédez comme suit:</p> <ol style="list-style-type: none"> <li>1. Si un cadenas a été installé sur à l'arrière du système, déverrouillez-le et retirez-le.</li> <li>2. Retirez toutes les vis des panneaux et mettez-les dans un endroit sûr.</li> <li>3. Retirez les panneaux.</li> </ol>
	<p>Afin de permettre le refroidissement et l'aération du système, réinstallez toujours les panneaux du boîtier avant de mettre le système sous tension. Le fonctionnement du système en l'absence des panneaux risque d'endommager ses pièces. Pour installer les panneaux, procédez comme suit:</p> <ol style="list-style-type: none"> <li>1. Assurez-vous de ne pas avoir oublié d'outils ou de pièces démontées dans le système.</li> <li>2. Assurez-vous que les câbles, les cartes d'extension et les autres composants sont bien installés.</li> <li>3. Revissez solidement les panneaux du boîtier avec les vis retirées plus tôt.</li> <li>4. Remettez le cadenas en place et verrouillez-le afin de prévenir tout accès non autorisé à l'intérieur du système.</li> <li>5. Rebranchez tous les cordons d'alimentation c. a. et câbles externes au système.</li> </ol>

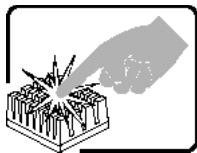

Le microprocesseur et le dissipateur de chaleur peuvent être chauds si le système a été sous tension. Faites également attention aux broches aiguës des cartes et aux bords tranchants du capot. Nous vous recommandons l'usage de gants de protection.

## Español

Lea todas las declaraciones de seguridad y precaución de este documento antes de realizar cualquiera de las instrucciones. Vea *Intel® Server Boards and Server Chassis Safety Information* en el CD Resource y/o en <http://www.intel.com/support/motherboards/server/sb/cs-010770.htm>.

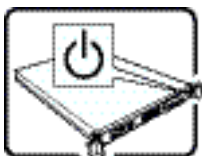

Nótese que el interruptor activado/desactivado en el panel frontal no desconecta la corriente alterna del sistema. Para desconectarla, deberá desenchufar todos los cables de corriente alterna de la pared o desconectar la fuente de alimentación.

Estos cables actúan como dispositivo de desconexión. La toma de corriente deberá estar situada cerca del equipo y ser de fácil acceso.



**INSTRUCCIONES DE SEGURIDAD:** Cuando extraiga la tapa del chasis para acceder al interior del sistema, siga las siguientes instrucciones:

1. Apague todos los dispositivos periféricos conectados al sistema.
2. Apague el sistema presionando el interruptor encendido/apagado.
3. Desconecte todos los cables de alimentación CA del sistema o de las tomas de corriente alterna.
4. Identifique y desconecte todos los cables enchufados a los conectores E/S o a los puertos situados en la parte posterior del sistema.
5. Cuando manipule los componentes, es importante protegerse contra la descarga electrostática (ESD). Puede hacerlo si utiliza una muñequera antiestática sujeta a la toma de tierra del chasis - o a cualquier tipo de superficie de metal sin pintar.
6. No ponga en marcha el sistema si se han extraído las tapas del chasis.

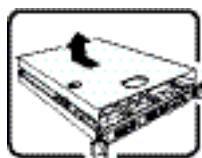

Después de completar las seis instrucciones de SEGURIDAD mencionadas, ya puede extraer las tapas del sistema. Para ello:

1. Desbloquee y extraiga el bloqueo de seguridad de la parte posterior del sistema, si se ha instalado uno.
2. Extraiga y guarde todos los tornillos de las tapas. Extraiga las tapas.

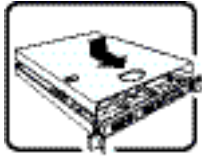

Para obtener un enfriamiento y un flujo de aire adecuados, reinstale siempre las tapas del chasis antes de poner en marcha el sistema. Si pone en funcionamiento el sistema sin las tapas bien colocadas puede dañar los componentes del sistema. Para instalar las tapas:

1. Asegúrese primero de no haber dejado herramientas o componentes sueltos dentro del sistema.
2. Compruebe que los cables, las placas adicionales y otros componentes se hayan instalado correctamente.
3. Incorpore las tapas al chasis mediante los tornillos extraídos anteriormente, tensándolos firmemente.
4. Inserte el bloqueo de seguridad en el sistema y bloquéelo para impedir que pueda accederse al mismo sin autorización.
5. Conecte todos los cables externos y los cables de alimentación CA al sistema.

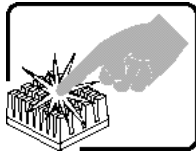

Si el sistema ha estado en funcionamiento, el microprocesador y el disipador de calor pueden estar aún calientes. También conviene tener en cuenta que en el chasis o en el tablero puede haber piezas cortantes o punzantes. Por ello, se recomienda precaución y el uso de guantes protectores.

## Italiano

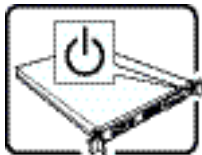

L'interruttore attivato/disattivato nel pannello anteriore non interrompe l'alimentazione in c.a. del sistema. Per interromperla, è necessario scollegare tutti i cavi di alimentazione in c.a. dalle prese a muro o dall'alimentazione di corrente.

Il cavo è considerato il dispositivo d'interruzione dell'alimentazione principale (in c.a.). La presa alla quale si collega il sistema deve essere installata vicino all'unità e deve essere facilmente accessibile.

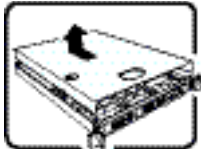
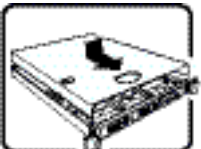
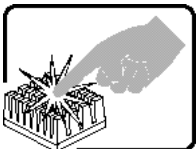

	<p><b>PASSI DI SICUREZZA:</b> Qualora si rimuovano le coperture del telaio per accedere all'interno del sistema, seguire i seguenti passi:</p> <ol style="list-style-type: none"> <li>1. Spegnerne tutti i dispositivi periferici collegati al sistema.</li> <li>2. Spegnerne il sistema, usando il pulsante spento/accesso dell'interruttore del sistema.</li> <li>3. Togliere tutte le spine dei cavi del sistema dalle prese elettriche.</li> <li>4. Identificare e sconnettere tutti i cavi attaccati ai collegamenti I/O od alle prese installate sul retro del sistema.</li> <li>5. Qualora si tocchino i componenti, proteggersi dallo scarico elettrostatico (SES), portando un cinghia anti-statica da polso che è attaccata alla presa a terra del telaio del sistema - qualsiasi superficie non dipinta - .</li> <li>6. Non far operare il sistema quando il telaio è senza le coperture.</li> </ol>
	<p>Dopo aver seguito i sei passi di SICUREZZA sopracitati, togliere le coperture del telaio del sistema come segue:</p> <ol style="list-style-type: none"> <li>1. Aprire e rimuovere il lucchetto dal retro del sistema qualora ve ne fosse uno installato.</li> <li>2. Togliere e mettere in un posto sicuro tutte le viti delle coperture.</li> <li>3. Togliere le coperture.</li> </ol>
	<p>Per il giusto flusso dell'aria e raffreddamento del sistema, rimettere sempre le coperture del telaio prima di riaccendere il sistema. Operare il sistema senza le coperture al loro proprio posto potrebbe danneggiare i componenti del sistema. Per rimettere le coperture del telaio:</p> <ol style="list-style-type: none"> <li>1. Controllare prima che non si siano lasciati degli attrezzi o dei componenti dentro il sistema.</li> <li>2. Controllare che i cavi, dei supporti aggiuntivi ed altri componenti siano stati installati appropriatamente.</li> <li>3. Attaccare le coperture al telaio con le viti tolte in precedenza e avvitarle strettamente.</li> <li>4. Inserire e chiudere a chiave il lucchetto sul retro del sistema per impedire l'accesso non autorizzato al sistema.</li> <li>5. Ricollegare tutti i cavi esterni e le prolunghe AC del sistema.</li> </ol>
	<p>Se il sistema è stato a lungo in funzione, il microprocessore e il dissipatore di calore potrebbero essere surriscaldati. Fare attenzione alla presenza di piedini appuntiti e parti taglienti sulle schede e sul telaio. È consigliabile l'uso di guanti di protezione.</p>



# Appendix C: Regulatory and Certification Information

---

## Product Safety and EMC Compliance

These Intel® RAID Modules have been evaluated for regulatory compliance as an Intel® end system, and is included as part of the end system certification. For information on end system certification, refer to the product regulatory certification for the end system level product.



## X-ON Electronics

Largest Supplier of Electrical and Electronic Components

*Click to view similar products for [Other Modules](#) category:*

*Click to view products by [Intel](#) manufacturer:*

Other Similar products are found below :

[AC1310](#) [AXXRPFKSSD](#) [B7A-R6F36](#) [RMS3CC080](#) [96RC-SAS-8P-PE-AD](#) [96RC-SAS-4P-PE-AD1](#) [VROCISSDMOD](#) [RS3WC080](#)  
[OKY3525-1](#) [OKY3065-6](#) [OKY3199-7](#) [OKY3222-2](#) [OKY3318](#) [OKY3318-1](#) [OKY3318-3](#) [OKY3368](#) [OKY3368-1](#) [OKY3369-2](#) [OKY3369-3](#)  
[OKY3370-1](#) [OKY3374-1](#) [OKY3375-6](#) [OKY3378-1](#) [OKY3380-2](#) [OKY3381](#) [OKY3387](#) [OKY3416](#) [OKY3420-5](#) [OKY3420-7](#) [OKY3425](#)  
[OKY3431-2](#) [OKY3443-1](#) [OKY3444-2](#) [OKY3449](#) [OKY3452-3](#) [OKY3459](#) [OKY3460-4](#) [OKY3463-5](#) [OKY3471-4](#) [OKY3471-6](#) [OKY3481-2](#)  
[OKY3482](#) [OKY3483](#) [OKY3507](#) [OKY3551-1](#) [OKY3605](#) [OKY3919](#) [FIT0827](#) [FIT0832](#) [FIT0767](#)