

82567 GbE Physical Layer Transceiver (PHY)

Datasheet

Product Features

- Reduced power consumption during normal operation and power down modes
- IEEE 802.3 Ethernet interface for 1000BASE-T, 100BASE-TX, and 10BASE-T applications (802.3, 802.3u, and 802.3ab) conformance
- Supports up to 9 kB jumbo frames (full duplex)
- Supports carrier extension (half duplex)
- Auto-negotiation with support for next page
- Smart speed operation, for automatic speed reduction on faulty cable plants
- Automatic MDI crossover capable
- PMA loopback capable (No echo cancel)
- Advanced power management:
 - Low power link up
 - Auto Connect Battery Saver - link disconnect
- Advanced cable diagnostics:
 - TDR
 - Channel frequency response
- Extended configuration load sequence
- Automatic resolution of FDX/HDX mismatch in 10/100 forced configurations
- Dual interconnect between MAC and PHY:
 - LCI for 10/100 Mb/s operation control traffic
 - GLCI for 1000 Mb/s operation
- Three LED outputs
- Multiple voltage regulation modes:
 - External voltage regulation
 - Fully integrated linear regulator (nominal 1.05 V, programmable)
 - Discrete linear voltage regulator (nominal 1.8 V-1.9 V)
- Supported ICH Integrated MAC Features:
 - Linksec (ICH10 only)
 - Manageability: vPro Compatible
 - Performance:
 - RSS Support
 - Checksum offload



INFORMATION IN THIS DOCUMENT IS PROVIDED IN CONNECTION WITH INTEL® PRODUCTS. NO LICENSE, EXPRESS OR IMPLIED, BY ESTOPPEL OR OTHERWISE, TO ANY INTELLECTUAL PROPERTY RIGHTS IS GRANTED BY THIS DOCUMENT. EXCEPT AS PROVIDED IN INTEL'S TERMS AND CONDITIONS OF SALE FOR SUCH PRODUCTS, INTEL ASSUMES NO LIABILITY WHATSOEVER, AND INTEL DISCLAIMS ANY EXPRESS OR IMPLIED WARRANTY, RELATING TO SALE AND/OR USE OF INTEL PRODUCTS INCLUDING LIABILITY OR WARRANTIES RELATING TO FITNESS FOR A PARTICULAR PURPOSE, MERCHANTABILITY, OR INFRINGEMENT OF ANY PATENT, COPYRIGHT OR OTHER INTELLECTUAL PROPERTY RIGHT. Intel products are not intended for use in medical, life saving, life sustaining, critical control or safety systems, or in nuclear facility applications.

Intel may make changes to specifications and product descriptions at any time, without notice.

Intel Corporation may have patents or pending patent applications, trademarks, copyrights, or other intellectual property rights that relate to the presented subject matter. The furnishing of documents and other materials and information does not provide any license, express or implied, by estoppel or otherwise, to any such patents, trademarks, copyrights, or other intellectual property rights.

IMPORTANT - PLEASE READ BEFORE INSTALLING OR USING INTEL® PRE-RELEASE PRODUCTS.

Please review the terms at http://www.intel.com/netcomms/prerelease_terms.htm carefully before using any Intel® pre-release product, including any evaluation, development or reference hardware and/or software product (collectively, "Pre-Release Product"). By using the Pre-Release Product, you indicate your acceptance of these terms, which constitute the agreement (the "Agreement") between you and Intel Corporation ("Intel"). In the event that you do not agree with any of these terms and conditions, do not use or install the Pre-Release Product and promptly return it unused to Intel.

Designers must not rely on the absence or characteristics of any features or instructions marked "reserved" or "undefined." Intel reserves these for future definition and shall have no responsibility whatsoever for conflicts or incompatibilities arising from future changes to them.

Intel processor numbers are not a measure of performance. Processor numbers differentiate features within each processor family, not across different processor families. See http://www.intel.com/products/processor_number for details.

This document contains information on products in the design phase of development. The information here is subject to change without notice. Do not finalize a design with this information.

The 82567 GbE Physical Layer Transceiver may contain design defects or errors known as errata which may cause the product to deviate from published specifications. Current characterized errata are available on request.

Hyper-Threading Technology requires a computer system with an Intel® Pentium® 4 processor supporting HT Technology and a HT Technology enabled chipset, BIOS and operating system. Performance will vary depending on the specific hardware and software you use. See http://www.intel.com/products/ht/Hyperthreading_more.htm for additional information.

Contact your local Intel sales office or your distributor to obtain the latest specifications and before placing your product order.

Copies of documents which have an order number and are referenced in this document, or other Intel literature may be obtained by calling 1-800-548-4725 or by visiting Intel's website at <http://www.intel.com>.

Intel and Intel logo are trademarks or registered trademarks of Intel Corporation or its subsidiaries in the United States and other countries.

*Other names and brands may be claimed as the property of others.

Copyright © 2006-2009, Intel Corporation. All Rights Reserved.



Contents

- 1.0 Introduction** 5
 - 1.1 Scope 6
 - 1.2 Reference Documents 6
 - 1.3 Product Codes..... 6
- 2.0 Signal Descriptions** 7
 - 2.1 Signal Type Definitions..... 7
 - 2.2 GLCI Interface Pins..... 7
 - 2.3 LCI Interface Pins..... 8
 - 2.4 Miscellaneous Pins 8
 - 2.5 PHY Pins 9
 - 2.5.1 LED Pins 9
 - 2.5.2 Analog Pins 9
 - 2.5.3 Testability Pins..... 9
 - 2.6 Power Supply Pins 10
- 3.0 Features** 11
 - 3.1 Feature Matrix and Product Information..... 11
 - 3.2 Power Saving Features..... 12
 - 3.2.1 Intel® Auto Connect Battery Saver (ACBS) 12
 - 3.2.2 Link Speed Battery Saver 12
 - 3.2.3 System Idle Power Saver (SIPS) 13
 - 3.2.4 Low Power Link Up (LPLU) 13
 - 3.2.5 LAN Disable 14
- 4.0 Voltage, Temperature, and Timing Specifications** 16
 - 4.1 Recommended Operating Conditions 16
 - 4.2 DC and AC Characteristics 16
 - 4.3 LED Electrical Specification 16
 - 4.4 Crystal Specifications 17
 - 4.5 Oscillator Specifications..... 19
 - 4.5.1 Oscillator High Voltage Configuration 19
 - 4.6 Power Consumption 20
 - 4.7 Power Delivery..... 23
 - 4.7.1 The 1.8 V-1.9 V Rail 23
 - 4.7.2 The 1.05 V Rail 23
 - 4.7.3 Voltage Regulator Schematics 23
 - 4.7.4 Voltage Regulator Power Supply Specifications 24
 - 4.7.5 PNP Specifications 25
 - 4.7.6 Power Sequencing 25
 - 4.8 Timing Parameters 26
 - 4.8.1 Timing Requirements 26
 - 4.8.2 Timing Guarantees 26
- 5.0 Package and Pinout Information** 27
 - 5.1 Package Information..... 27
 - 5.2 Thermal 27
 - 5.3 Internal Pull-Up Resistors 28
 - 5.4 Visual Pin Assignments..... 29



Revision History

Date	Revision	Description
Oct 2006	0.1	Initial release (Intel secret)
January 2007	0.25	Corrected pin numbers and made minor text corrections (Intel Confidential)
February 2007	0.26	Corrected GLAN TX pin numbers; added RSET & DIS_REG1_0 to the signal descriptions; corrected LAN_DISABLE# (active high) to LAN_DISABLE_N (active low); in the Visual Pin Assignment Diagram, pin 37, "LAN Enable" was corrected to "LAN_Disable_N"; removed VHV references.
April 2007	0.50	Minor text updates.
May 2007	0.51	Updated power consumption target values.
August 2007	0.75	Added Low-Power feature information, Recommended Operating Conditions, DC and AC Characteristics, Preliminary LED/TEST/JTAG I/F DC Specifications, Crystal Specification, Voltage Regulator Power Supply Specification, PnP Transistor Specification, and Power Sequencing information.
September 2007	0.76	Changed IEEE 802.3ab designation to conformance
November 2007	1.5	Updated features list; updated Reference Documents; added SKU information; Updated power rail information (1.8 V-1.9 V, 1.05 V); clarified oscillator placement information; updated power target information; corrected Slope and Operation Range characteristics for 1.8-1.9 V rail; added pointer to reference schematics for regulator information.
November 2007	1.51	Deleted "programmable" from 1.8 V-1.9 V power rail listing in the Features list.
December 2007	1.6	Corrected 1.05 V power rail tolerance to +7% / -5% (1.0 V min, 1.12 V max)
February 2008	1.7	Added XOR test file information; updated SKU and Features table; added information regarding using LAN_PHY_PWR_CTRL ; updated Recommended Operating Conditions; updated DC and AC characteristics; updated crystal/oscillator specifications; updated the measured power consumption values; updated reference schematic link information; updated the 1.8 V-1.9 V rail operational range value; updated the 1.05 V rail operational range value; corrected P _{tot} Min value in PNP specification;
March 2008	2.0	Updated Reference Documents list; updated Testability Pins table; updated SKU table; updated Power Consumption tables 7-10; updated power delivery drawing; added Ambient Operating Temperature table.
March 2008	2.1	Updated SKU table; Combined Tables 5 and 6 to create new Table 5.
April 2008	2.2	Updated Table 2.4 (added pull-up type designation to LAN_DISABLE_N); updated Table 12 (added LAN_DISABLE_N information)
July 2008	2.3	Updated WoL information; added System Idle Power Saver information; updated crystal tolerances; updated LED pin table; updated pinout illustration; updated package tolerance values.
April 2009	2.4	Updated SKU table; added <i>SPI FLASH Programming Guide</i> and <i>82567 Specification Update</i> to Reference Documents; added note regarding ACBS operation; added WoL power information; added Solution Power information to Power Consumption table; clarified crystal Drive Level specification.

Note: The revision numbering system changed with the first November 2007 release. At that time, the collateral for this device began synchronizing with platform collateral revision numbering. There were no releases between versions 0.76 and 1.5.

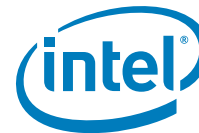

1.0 Introduction

The 82567 is a single port GbE Physical Layer Transceiver (PHY) that connects to its Media Access Controller (MAC) through a dedicated interconnect. The 82567 is based on Intel's GbE PHY technology, and supports operation at data rates of 10/100/1000 Mb/s. The physical layer circuitry provides a standard IEEE 802.3 Ethernet interface for 10BASE-T, 100BASE-TX, and 1000BASE-T applications (802.3, 802.3u, and 802.3ab).

The 82567 operates with the ICH9/9M/10 chipset that incorporates and integrates the MAC, which is referred to as the ICH9/9M/10 LAN.

The 82567 is packaged in a small footprint QFN package. The package size is 8 mm x 8 mm with a pin-to-pin spacing of 0.5 mm, making it attractive for small form-factor platforms.

The 82567 interfaces with its MAC through two interfaces: Gigabit LAN Connect Interface (GLCI) and LAN Connect Interface (LCI). The GLCI is a high-speed proprietary serial interface. The LCI is a low-speed proprietary parallel bus. The 82567 operates using both interfaces; the GLCI for 1000 Mb/s traffic and LCI for all other traffic types.

Figure 1 identifies the major components of the 82567 architecture.

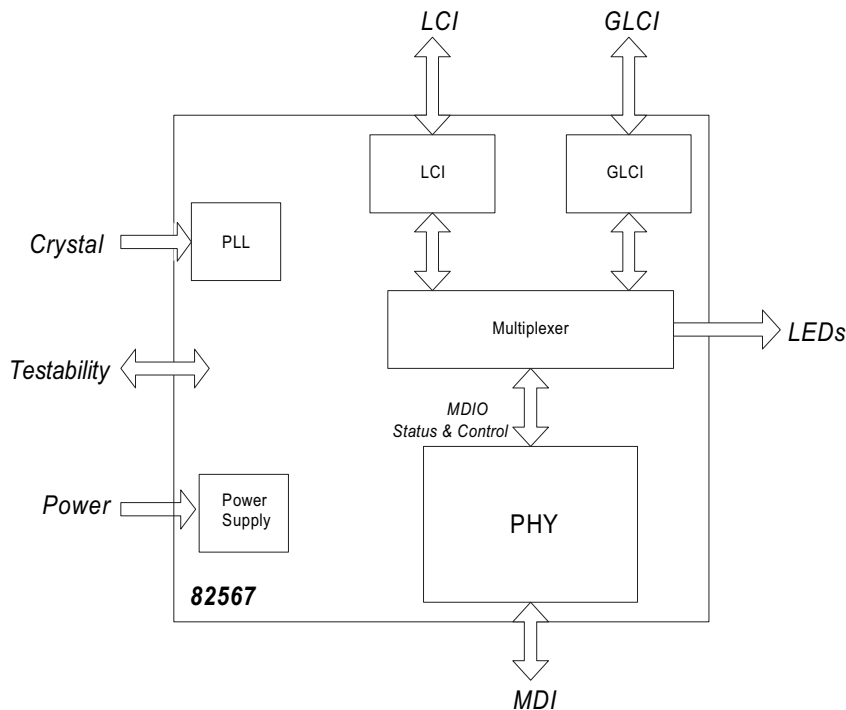
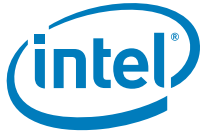

Figure 1. 82567 Block Diagram



1.1 Scope

This document contains datasheet specifications for the 82567, including signal descriptions, DC and AC parameters, packaging data, and pinout information.

1.2 Reference Documents

This document assumes that the designer is acquainted with high-speed design and board layout techniques. The following documents provide application information:

- *IEEE Standard 802.3*, 2002 Edition. Incorporates various IEEE Standards previously published separately. Institute of Electrical and Electronic Engineers (IEEE).
- *I/O Control Hub 9 NVM Map and Programming Information*. Intel Corporation.
- *I/O Control Hub 9M NVM Map and Programming Information*. Intel Corporation.
- *I/O Control Hub 10 NVM Map and Programming Information*. Intel Corporation.
- *ICH9 External Design Specification (EDS)*, Intel Corporation.
- *ICH10 External Design Specification (EDS)*, Intel Corporation.
- *I/O Controller Hub 8/9/10 and 82566/82567/82562V Software Developer's Manual*. Intel Corporation.
- *Information Technology - Telecommunication & Information Exchange Between Systems - LAN/MAN - Specific Requirements - Part 3: Carrier Sense Multiple Access with Collision Detection (CSMA/CD) Access Method and Physical Layer*.
- *Intel® ICH7, ICH8, ICH9 and ICH10 – SPI Family Flash Programming Guide Application Note*. Intel Corporation. Contact your Intel representative to obtain this document.
- *Intel® 82567 Specification Update*, Intel Corporation.

1.3 Product Codes

Table 1 lists the product ordering codes for the 82567.

Table 1. Product Ordering Codes¹

Note: For more information regarding the differences between the versions, please contact your Intel field representative.

Part Number	Product Name	Description
XX82567LM	Intel® 82567 Gigabit Platform LAN Connect Device	Gigabit LAN for high-end Corporate and Workstation designs
XX82567LF	Intel® 82567 Gigabit Platform LAN Connect Device	Gigabit LAN for mainstream Corporate and high-end desktop designs
XX82567V	Intel® 82567 Gigabit Platform LAN Connect Device	Gigabit LAN for consumer designs

1. For more information regarding the differences, please contact your Intel field representative.



2.0 Signal Descriptions

2.1 Signal Type Definitions

The signals are defined as follows in the table below:

Type	Description
In (I)	Standard input-only signal.
Out (O)	Totem pole output is a standard active driver.
T/s	Tri-state is a bi-directional, tri-state input/output pin.
S/st/s	Sustained tri-state is an active low tri-state signal owned and driven by one and only one agent at a time. The agent that drives an s/t/s pin low must drive it high for at least one clock before letting it float. A new agent cannot start driving an s/t/s signal any sooner than one clock after the previous owner tri-states it.
O/d	Open drain enables multiple devices to share as a wire-OR.
A-in	Analog input signal.
A-out	Analog output signal.
B	Input bias.
P	Power
PU	Pull-up.
PD	Pull-down.

2.2 GLCI Interface Pins

Signal Name	Pin	Type	Description
GLAN_RXP GLAN_RXN	55 56	A-in	GLCI Serial Data Input This is the differential input for GLCI (MAC to PHY).
GLAN_TXN GLAN_TXP	53 52	A-out	GLCI Serial Data Output This is the differential output for GLCI (PHY to MAC).
XTAL2 XTAL1	9 10	A-out A-in	Crystal Oscillator An external 25 MHz crystal can be connected to these pins to generate a 25 MHz reference clock. A 25 MHz reference clock can also be generated from an external 1.4 V oscillator connected to the XTAL1 input pin.



2.3 LCI Interface Pins

Signal Name	Pin	Type	Description
JKCLK	45	O	LCI/GLCI Clock The clock is driven by the 82567 according to the operation mode: In 1000 Mb/s mode, JKCLK frequency is 62.5 MHz. In 100 Mb/s mode, JKCLK frequency is 50 MHz. In 10 Mb/s mode and no link, JKCLK frequency is 5 MHz. In power down mode, JKCLK frequency is 0 MHz.
JRSTSYNC	50	I	Reset/SYNC This pin is driven by the MAC and has two functions: Reset. When this pin is asserted beyond one LCI clock, the 82567 refers to this signal as a reset signal. However, to ensure that the 82567 resets, the reset should remain active for at least 1ms. This functionality is also used to bring the 82567 out of a power-down state. SYNC. When this pin is activated synchronously for one LCI clock only, it is used for synchronization between the MAC and the 82567 on LCI word boundaries.
JTXD2 JTXD1 JTXD0	44 43 42	I	LCI Transmit Data These pins are used for receiving real time control and management data transmitted by the ICH9 LAN. These pins are also used to move out of band control from the MAC to the 82567. The pins should be fully synchronous to JKCLK.
JRXD2 JRXD1 JRXD0	49 48 47	O	LCI Receive Data These pins are used for transmitting real time control and management data received by the ICH9 LAN. These pins are also used to move out of band control from the 82567 to the MAC.

2.4 Miscellaneous Pins

Signal Name	Pin	Type	Description
IEEE_TEST_P IEEE_TEST_N	12 13	A-out	Positive side of the high speed differential debug port for the 82567.
LAN_DISABLE_N	37	I/PU	When this pin is set, the 82567 consumes minimum power and is disabled.
RSET	15		This pin should be connected through 4.99 kohm, +-1%, to ground.
RESERVED_NC	51		Do not connect.

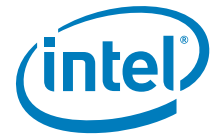

2.5 PHY Pins

2.5.1 LED Pins

Signal Name	Pin	Type	Description
LED0	4	O	LED0 This signal is used for the programmable LED. It is programmed through the Intel® ICH9/ICH10 NVM word 18h.
LED1	2	O	LED1 This signal is used for the programmable LED. It is programmed through the Intel® ICH9/ICH10 NVM word 17h.
LED2	1	O	LED2 This signal is used for the programmable LED. It is programmed through the Intel® ICH9/ICH10 NVM word 18h.

Note: Reference the following Application Notes for details regarding the programming of the LEDs and the various modes.

- *I/O Control Hub 9 NVM Map and Programming Information Application Notes*
- *I/O Control Hub 9M NVM Map and Programming Information Application Notes*
- *I/O Control Hub 10 NVM Map and Programming Information Application Notes*

2.5.2 Analog Pins

Signal Name	Pins	Type	Description
MDI_PLUS[0] MDI_MINUS[0]	27 26	A	Media Dependent Interface [0] In MDI configuration, MDI_PLUS[0]+/- is used for the transmit pair and in MDI-X configuration MDI_MINUS[0]+/- is used for the receive pair.
MDI_PLUS[1] MDI_MINUS[1]	23 22	A	Media Dependent Interface [1] In MDI configuration, MDI_PLUS[1]+/- is used for the receive pair and in MDI-X configuration MDI_MINUS[1]+/- is used for the transmit pair.
MDI_PLUS[2] MDI_MINUS[2] MDI_PLUS[3] MDI_MINUS[3]	21 20 17 16	A	Media Dependent Interface [2:3] For 1000BASE-T MDI configuration, MDI_PLUS[2:3]+/- is used for the receive pair and in MDI-X configuration MDI_MINUS[2:3]+/- is used for the transmit pair.

2.5.3 Testability Pins

Signal Name	Pin	Type	Description
JTAG_TCK	40	I	JTAG Clock Input
JTAG_TDI	7	I/PU	JTAG TDI Input
JTAG_TDO	6	T/s	JTAG TDO Output

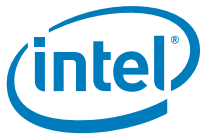

JTAG_TRST	35	I	JTAG Reset
JTAG_TMS	39	I/PU	JTAG TMS Input
TEST_EN	36	T/s	Test Mode Enable This signal enables test mode capabilities. It should be strapped to GND for normal operation.

Note: The 82567 uses the JTAG interface to support XOR files for manufacturing test. BSDL is not supported.

2.6 Power Supply Pins

Signal Name	Pin	Type	Description
VCC3_3	3 28 46	P	3.3 VDC Supply This is connected to the 82567.
VCC1_05	5 8 33 38	P	1.05 V DC Supply This is connected to the 82567.
VCC1_8	11 14 18 19 24 25 30 41 32 54	P	1.8 V-1.9 V DC Supply This is connected to the 82567. 82567 supports both 1.8 V and 1.9 V for this DC supply.
CTRL10	31	Out	1.05 V Control This is the voltage control signal for the external PNP transistor that generates the 1.05 V supply.
CTRL18	29	Out	1.8 V-1.9 V Control This is the voltage control signal for the external PNP transistor. The default voltage generated from the external PNP is 1.9 V.
DIS_REG1_0	34	A	When set to 3.3 V, configured to use external regulator for 1.05 V supply. When set to 0, the internal regulator will be used for 1.05 V supply. A 1 kOhm pull up or 1 kOhm pull down resistor is required, depending on the desired configuration.



3.0 Features

3.1 Feature Matrix and Product Information

The following matrix shows the features available with the 82567:

82567 Sku Platform/Features Information			Performance			Extended Power			Advanced Features***									
Platform	Code Name	Device ID	Jumbo Frames (up to 9k)	802.1Q & 802.1p	Receive Side Scaling (RSS)	2 Tx & 2 Rx Queues	Auto MDI/MDIX	Intel® Auto-Connect Battery Saver (ACBS)	Link Speed Battery Saver	Low Power Linkup (LPLU)	Basic Manageability **	Ability to Initiate a Team*	LinkSec/MACSec	iSCSI Boot	Intel® Stable Image Platform program	Intel® Vpro Processor Technology™	Intel® VIV Processor Technology™	Product Name
Embedded	ICH8M + 82567V	1501					X	X	X									Intel® 82567V-3 Gigabit Network Connection
High End Desktop/ Workstation	ICH9/9R + 82567LM	10E5	X	X	X	X	X	X	X		X			X	X			Intel® 82567LM-4 Gigabit Network Connection
Mobile	ICH9m+82567LM	10F5	X	X	X	X	X	X	X	X	X			X	X			Intel® 82567LM Gigabit Network Connection
	ICH9m+82567LF	10BF		X			X	X	X	X	X			X				Intel® 82567LF Gigabit Network Connection
	ICH9m+82567V	10CB					X	X	X									Intel® 82567V Gigabit Network Connection
Desktop	ICH10/10R+82567LM	10CC	X	X	X	X	X	X	X	X	X			X			X	Intel® 82567LM-2 Gigabit Network Connection
	ICH10/10R+82567LF	10CD		X			X	X	X	X	X			X			X	Intel® 82567LF-2 Gigabit Network Connection
	ICH10/10R+82567V	10CE					X	X	X								X	Intel® 82567V-2 Gigabit Network Connection
Desktop	ICH10D/10DO+82567LM	10DE	X	X	X	X	X	X	X	X	X	X	X	X	X	X		Intel® 82567LM-3 Gigabit Network Connection
	ICH10D/10DO+82567LF	10DF		X			X	X	X	X	X			X	X			Intel® 82567LF-3 Gigabit Network Connection

* Note: Teaming is supported on Corporate SKU's with no-AMT

** Basic manageability includes ASF & DASH support. For firmware and hardware requirements, please refer to Intel® chipset documentation.

*** For Platform features, other Intel® component skus may be required. Please refer to the relevant Intel® component (chipset/CPU) documentation for sku requirements.

Production information is in the 82567 Specification Update available from Intel on the Intel Business Link. Contact your Intel representative for more information.

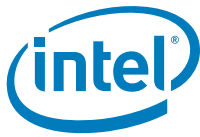

3.2 Power Saving Features

This section provides information about the low power configurations for the 82567.

3.2.1 Intel® Auto Connect Battery Saver (ACBS)

Intel Auto Connect Battery Saver for the 82567 is a hardware-only feature that automatically reduces the PHY to a lower power state when the power cable is disconnected. When the power cable is reconnected, it will renegotiate the line speed following IEEE specs for autonegotiation. By default, autonegotiation starts at 1GHz, then 100 Mb full duplex/half duplex, then 10 Mb full duplex/half duplex.

Note: Intel Auto Connect Battery Saver for the 82567 is only supported if autonegotiation is enabled. If link speed is forced and the network cable is disconnected, the 82567 will not enter ACBS, resulting in higher power consumption than specified in section 4.6.

82567 ACBS works in both S0 and Sx states. Unlike the 82566 External ACBS implementation, 82567 ACBS requires no BIOS, software, or external on-board hardware, limiting BOM cost and making implementation easier. When the 82567 PHY is in ACBS mode, the LAN drivers stay loaded and the PHY consumes 37 mW (Solution power is 63 mW). The crystal and LCI/GLCI interface clock still run, but all unneeded internal clocks are gated. Since 82567 ACBS has no driver control, the feature is always enabled, allowing power savings by default. The table below compares 82566 External ACBS implementation and 82567 ACBS implementation:

		82566 ACBS	82567 ACBS
Implementation (HW/SW/FW)	HW	Needs on board hardware (energy detect circuit, power FET Switch) (BOM Cost ~\$0.2)	No external BOM (\$0)
	Driver	Driver controls entry into ACBS. Enabling/Disabling ACBS possible from driver.	No Driver control. Feature always enabled. Enabling/Disabling ACBS is not possible from the driver.
	BIOS	Minor changes needed for LAN_PHY_PWR_CTRL (ICH output) configuration.	No BIOS changes needed
	FW	NVM Soft Straps and GbE NVM needs to be set up.	NVM does not need to be set up.
AC/DC modes		Supported only in DC mode	Supported in both AC and DC modes.
Sx support		Cannot enter ACBS mode in Sx states.	Can enter ACBS mode in both S0 and Sx states
LAN Power Rails		3.3/1.8/1.05 V are all turned off in IVRd/IVRi configurations	3.3/1.8-1.9/1.05 V rails are all left on
PHY Power Consumption		~7mW	37 mW PHY power (63 mW solution power)

3.2.2 Link Speed Battery Saver

Link Speed Battery Saver is a power saving feature that negotiates to the lowest speed possible when a Mobile system operates in DC mode to save power. When in AC mode, where performance is more important than power, it negotiates to the highest speed

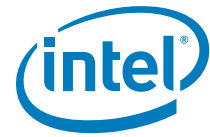

possible. The Windows NDIS drivers (Windows XP and later), monitor the AC-to-DC transition on the system to make the PHY negotiate to the lowest connection speed supported by the link partner (usually 10 Mb) when the user unplugs the power cable (switches from AC to DC power). When the AC cable is plugged in, the speed will negotiate back to the fastest LAN speed. This feature can be enabled/disabled directly from DMiX or through the Advanced Settings of the Window's driver.

When transferring packets at 1000/100 Mbps speed, if there is an AC-to-DC transition, the speed will renegotiate to the lower speed. Any packet that was in process will be retransmitted by the protocol layer. If the link partner is hard-set to only advertise a certain speed, then the driver will negotiate to the advertised speed. Since the feature is driver based, it is available in S0 state only.

Link Speed Battery Saver handles duplex mismatches/errors on link seamlessly by re-initiating auto negotiation while changing speed. Link Speed Battery Saver also supports Spanning Tree Protocol.

Note: The packets would get re-transmitted for any protocol other than TCP as well.

3.2.3 System Idle Power Saver (SIPS)

System Idle Power Saver (SIPS) is a software-based power saving feature that is enabled only with Microsoft* Windows* Vista*. This feature is only supported in the S0 state and can be enabled/disabled in the Advanced Tab of the Windows driver or through DMiX. The power savings from this feature is dependent on the link speed of the device. Please refer to Section 4.6 Tables 6-9 for the power dissipated in each link state.

SIPS is designed to save power in mobile systems by negotiating to the lowest possible link speed when both the network is idle and the monitor is turned off due to inactivity. The SIPS feature is activated based on both of the following conditions.

- The Windows* Vista* NDIS driver receives notification from the Operating System (OS) when the monitor is turned "OFF" due to non-activity.
- The LAN driver monitors the current network activity and determines that the network is idle.

Then, with both the monitor "OFF" and the network idle, the LAN negotiates to the lowest possible link speed supported by both the PHY and the link partner (typically 10 Mb). If the link partner is hard-set to only advertise a certain speed, then the LAN will negotiate to the advertised speed. This link speed will be maintained until the LAN driver receives notification from the OS that the monitor is turned "ON," thus exiting SIPS and re-negotiating to the highest possible link speed supported by both the PHY and the link partner. If SIPS is exited when transferring packets, any packet that was being transferred will be re-transmitted by the protocol layer after re-negotiation to the higher link speed.

3.2.4 Low Power Link Up (LPLU)

Low Power Link Up is a firmware/hardware based feature that allows the designer to make the PHY negotiate to the lowest connection speed first and then to the next higher speed and so on. This setting allows users to save power when power is more important than performance.

When speed negotiation starts, the PHY tries to negotiate for a 10 Mb/s link, independent of speed advertisement. If link establishment fails, the PHY tries to negotiate with different speeds. It enables all speeds up to the lowest speed supported by the partner. For example, if the 82567 advertises 10 Mb/s only and the link partner supports 1000/100 Mbps only, a 100Mbps link is established.

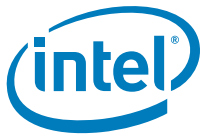

LPLU is controlled through the LPLU bit in the PHY Power Management register. The MAC sets and clears the bit according to hardware/software settings. The 82567 auto-negotiates with the updated LPLU setting on the following auto-negotiation operation. The 82567 does not automatically auto-negotiate after a change in the LPLU value. LPLU is not dependent on whether the system is in AC or DC mode. In S0 state, Link Speed Battery Saver overrides the LPLU functionality.

LPLU is enabled for Non-D0a states by GbE NVM image word 17h (bit 10)

- 0b = Low Power Link Up is disabled.
- 1b = Low Power Link Up is enabled in all non-D0a states.

LPLU power consumption depends on what speed it negotiates at. This datasheet includes all of the power numbers for the 82567 in the various speeds; see section 4.6, Tables 1-4.

3.2.5 LAN Disable

82567 has a LAN_DISABLE_N input pin that can be used by the BIOS to disable the PHY. The addition of this feature simplifies the PHY disable feature from the BIOS relative to the LAN Disable sequence used in 82566.

LAN_DISABLE_N is an active low input and when asserted, it loses all functionality other than the ability to power up again. Asserting LAN_DISABLE_N causes:

- GLCI enters electrical idle
- JKCLK is stopped to the MAC
- 25MHz clock remains active
- 82567 tri-states its output buffers
- WOL is not supported

On de-assertion:

- PHY sends JKCLK to MAC; MAC asserts JRSTSYNC
- PHY goes through usual initialization process.

Important Note:

Be sure to check for the latest LAN Disable and LAN_PHY_PWR_CTRL design guidelines. The information in the Specification Updates listed below supercedes the general LAN disable recommendations below.

Depending on which I/O Control Hub you are connecting, the information can be found in the errata section of the following documents:

- *I/O Controller Hub 9 (ICH9) Family Specification Update*
- *I/O Controller Hub 10 (ICH10) Family Specification Update*

3.2.5.1 General LAN Disable Recommendations

LAN_DISABLE_N needs to be connected to the GPIO12/LAN_PHY_PWR_CTRL output of ICH9, ICH9M, or ICH10. The GPIO12 needs to be configured using ICH soft straps as LAN_PHY_PWR_CTRL (bit [20] of STRP0 register - LAN_PHY_PWR_CTRL/GPIO12 Select (LAN_PHY_PWR_GPIO12_SEL) set to "1." This can be done with the Intel FIT tool by setting LAN_PHY_PWR_CTRL in ICH STRP0 to native mode ("1"). Please refer to ICH9 EDS Section 22.2.5.1 for more details.



In addition, LAN_PHY_PWR_CTRL can also be used to turn the 3.3 V power off to the 82567 when the PHY is disabled. This will also turn the PHY off when in Sx state and WOL is disabled from the OS (through driver settings) for systems that have ME disabled. This capability is called PHY Power Down and can be enabled/disabled through GbE NVM Word 0x13.9.

The figure below shows the power delivery for 82567 and ICH LAN along with the recommended connection for LAN_PHY_PWR_CTRL to LAN_DISABLE_N pin of 82567.

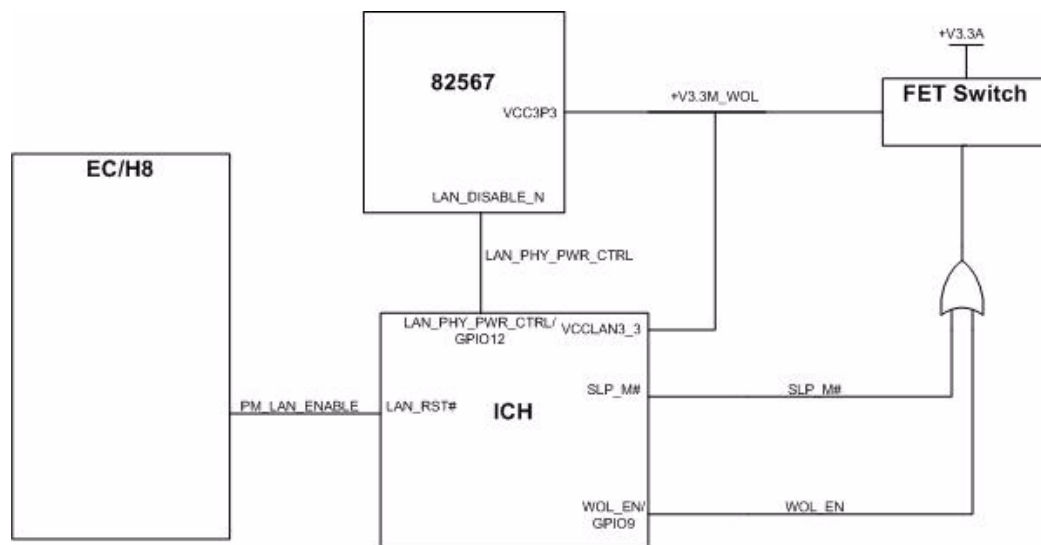

Note: LAN_PHY_PWR_CTRL should be connected directly to LAN_DISABLE_N pin of 82567

Note: LAN_PHY_PWR_CTRL cannot be used to gate the 3.3V power rail to the ICH LAN. Please refer to 82567 Specification Update for more information on LAN_PHY_PWR_CTRL connection.

Figure 2. Recommended Platform Power Delivery for 82567.

4.0 Voltage, Temperature, and Timing Specifications

4.1 Recommended Operating Conditions

Table 2. Recommended Operating Conditions

Symbol	Parameter	Min	Max	Unit
VCCP	Periphery Voltage Range	3.0	3.6	V
VCC1p8	Core/Analog Voltage Range	1.71	2.015	V
VCC1p0	Core Digital Voltage Range	0.98	1.12	V

4.2 DC and AC Characteristics

Table 3. DC and AC Characteristics

Symbol	Parameter	Specification			Units
		Minimum	Typical	Maximum	
V1a	High-threshold for 3.3 V supply	2.2	2.3	2.4	V
V2a	Low-threshold for 3.3 V supply	2.1	2.2	2.5	V
V1b	High-threshold for 1.05 V supply	0.65	0.7	0.75	V
V2b	Low-threshold for 1.05 V supply	0.55	0.6	0.65	V
V1c	High-threshold for 1.8-1.9 V supply	1.15	1.2	1.25	V
V2c	Low-threshold for 1.8-1.9 V supply	1.1	1.15	1.2	V

4.3 LED Electrical Specification

Table 4. LED Electrical Specification

Symbol	Condition	Min	Nom	Max	Units
VDDO	-	3.0	3.3	3.6	V
V _{il}	-	-0.65		1.0	V
V _{ih}	-	2.0		VDDO + 0.4	V
Input Leakage	0 < V _{in} < VDDO			10	μA
I _{ol} @V _{ol} =0.4 V	SR=11	12			mA
I _{oh} @V _{oh} =VDDO - 0.4 V	SR=11	12			mA
C _{in}	-			5	pF

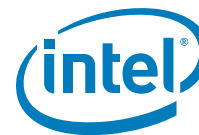

4.4 Crystal Specifications

Following are the recommended crystal specifications for operation with the 82567.

Parameter Name	Symbol	Recommended Value	Max/Min Range	Conditions
Frequency	f_o	25.000 MHz	-	@25 °C
Vibration mode	-	Fundamental	-	-
Cut	-	AT	-	-
Operating/Calibration Mode	-	Parallel	-	-
Frequency Tolerance	$\Delta f/f_o$ @25°C	±30 ppm	Note ¹	@25 °C
Temperature Tolerance	$\Delta f/f_o$	±30 ppm	Note ¹	-
Operating Temperature	T_{opr}	-20 to +70 °C	Note ¹	-
Non Operating Temperature	T_{opr}	-40 to +90 °C	-	-
Equivalent Series Resistance (ESR)	R_s	40 Ω	50 Ω	@25 MHz
Load Capacitance	C_{load}	18 pF (max 24 pF)	Note ¹	-
Shunt Capacitance	C_o	6 pF	Note ¹	-
Pullability from Nominal Load Capacitance	$\Delta f/C_{load}$	15 ppm/pF max	-	-
Max Drive Level	D_L	300 μ W	Note ⁴	-
Insulation Resistance	IR	500 M Ω min		@ 100 VDC
Aging	$\Delta f/f_o$	±5 ppm per year	±5 ppm per year	-
Differential Board Capacitance	C_D	2 pF	Note ²	
Board Capacitance	C_s	4 pF	Note ³	-
External Capacitors	C_1, C_2	27 pF	Note ¹	-
Board Resistance	R_s	0.1 Ω	1 Ω	-

- When not using values within 1% of the recommended values, the following procedures must be used:
 - On the board with the crystal and the 82567, measure the clock at the output of the receive and transmit lines.
 - Change C_1 and C_2 to meet with the 25 MHz requirement.
 - Ensure the demand on the 25 MHz clock has a deviation of less than 30 ppm (for example, 25 MHz \pm 750 Hz).
 - If the measured frequency is higher than 25.00075 MHz, replace capacitors C_1 and C_2 with larger capacitors.
 - If the measured frequency is lower than 24.99925 MHz, replace capacitors C_1 and C_2 with smaller capacitors.
- Differential board capacitance is the capacitance between Ser_CLK_PLUS and Ser_CLK_MINUS.
- Board capacitance is the differential capacitance between the input and output. This parasitic capacitance must be less than or equal to the specification. This value can change up to 10%. The procedures listed in footnote "1" must be followed to comply with the ppm specification.
- Crystal must meet or exceed the specified drive level (D_L). A crystal with a specified drive level of less than 300 μ W does not meet this requirement.

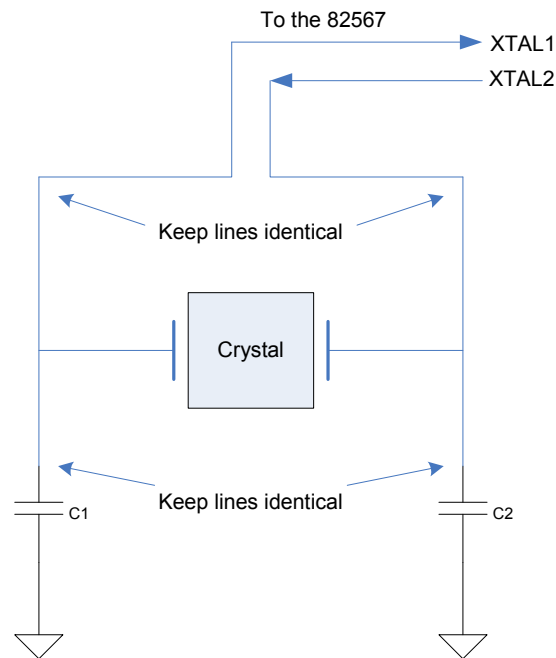
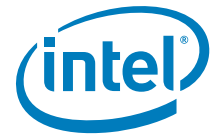

Figure 3. Crystal Connectivity to the 82567

The current from the 82567 does not change regardless of generating the 1.05 V using the on-die transistor or an external pass transistor. The total current demand remains constant, but the power dissipated by the 82567 package changes. The 1.05 V power is either on-die or at the external pass transistor.



4.5 Oscillator Specifications

Table 5. Oscillator Specifications and Timing Requirements

Parameter Name	Symbol/Parameter	Conditions	Min	Typ	Max	Unit
Frequency	f	@25 °C]		25.0		MHz
Swing	V _{p-p}		3	3.3	3.6	V
Frequency Tolerance	f/f ₀	-20 to +70		±30		ppm
Temperature Stability		0 °C to 70 °C		±30		ppm
Operating Temperature	T _{opr}	-20 to +70 °C				
Aging	f/f ₀			±5 ppm per year		ppm
Coupling capacitor	C _{coupling}		12	15	18	pF
Calibration mode	Parallel					
Oscillator Load Capacitance				18		pF
Shunt Capacitance					6	pF
Series Resistance, R _s					50	Ω
Drive Level					300	μW
Insulation Resistance		@ 100 VDC	500			MΩ
T _{H_XTAL_IN}	XTAL_IN High Time		13	20		ns
T _{L_XTAL_IN}	XTAL_IN Low Time		13	20		ns
T _{R_XTAL_IN}	XTAL_IN Rise	10%-90%			5	ns
T _{F_XTAL_IN}	XTAL_IN Fall	10%-90%			5	ns
T _{J_XTAL_IN}	XTAL_IN Total Jitter				200 ¹	ps

1 Broadband peak-peak=200pS, Broadband rms=3pS, 12 kHz to 20 MHz rms= 1ps

XTAL_IN/XTAL_OUT Timing

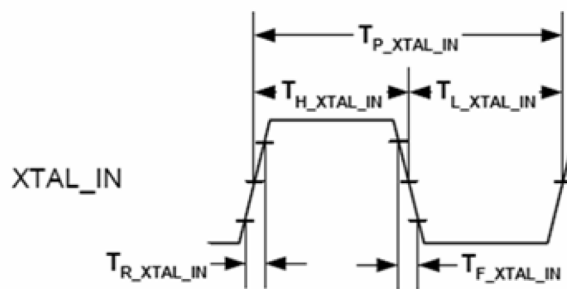

4.5.1 Oscillator High Voltage Configuration

This configuration involves capacitor C1, which forms a capacitor divider with C_{stray} of about 20 pF. This attenuates the input clock amplitude and adjusts the clock oscillator load capacitance.

$$V_{in} = VDD * (C1 / (C1 + C_{stray}))$$

$$V_{in} = 3.3 * (C1 / (C1 + C_{stray}))$$

This enables load clock oscillators of 15 pF to be used. If the value of C_{stray} is unknown, C₁ should be adjusted by tuning the input clock amplitude to approximately 1.2-1.8 V_{ptp}. If C_{stray} equals 20 pF, then C₁ is 15 pF ±10%. A low capacitance, high impedance probe (C < 1 pF, R > 500 K_Ω) should be used for testing. Probing the parameters can affect the measurement of the clock amplitude and cause errors in the adjustment. A test should also be done after the probe has been removed for circuit operation. If jitter performance is poor, a lower jitter clock oscillator can be implemented.

Note: C_{stray} shown in the figure below is not an actual discrete capacitor, but a representation of the board capacitance and is not to be placed in the actual design.

Note: Measure the V_{ptp} at the XTAL1 pin to ensure that it is never over 1.8 V. Overvoltage could lead to a silicon reliability concern.

Note: Keep C₁ close to the XTAL1 pin of the 82567. This will help make the value of C_{stray} less dependent on the PCB (Total C_{stray} is a combination of C_{stray} of PCB and C_{stray} of silicon).

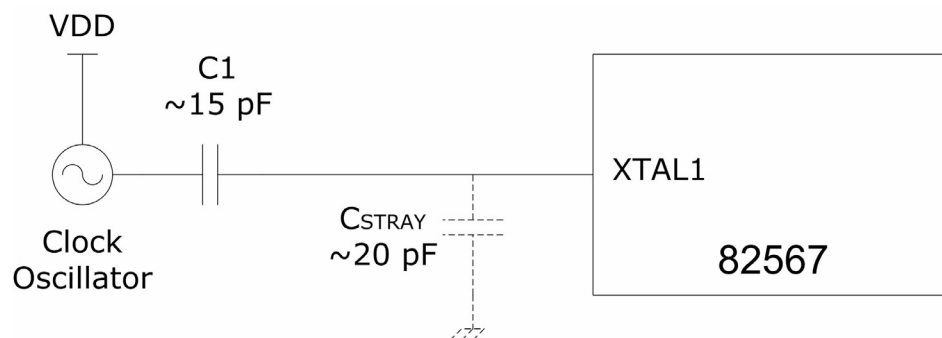

4.6 Power Consumption

The following table lists the measured values for the 82567's power. The numbers apply to the 82567 power dissipation with External Voltage Regulators (EVRs). Power is reduced according to link speed and link activity.



Table 6. Power Consumption—82567 with external Voltage regulator, 1.9V (VCC1P8)

State	Mode	3.3 V Current [mA]	1.9 V Current [mA]	1.05 V Current [mA]	82567 Power [mW]	Solution Power [mW]
S0 - Max	1000Mbps Active, 90°C [Ta]	22	256	115	680	1297
	1000Mbps Idle, 90°C [Ta]	22	256	110	675	1280
S0 - Typ	1000Mbps Active	22	254	112	673	1280
	1000Mbps Idle	22	254	106	667	1261
	100Mbps Active	25	72	18	238	380
	100Mbps Idle	25	72	18	238	380
	10Mbps Active	4	106	6	221	383
	10Mbps Idle	4	64	6	141	244
	Cable Disconnect (ACBS)	3	12	4	37	63
	Cable Disconnect (82567V only, no ACBS)	3	23	7	61	109
SX	LAN Disable	3	6	3	24	40
	10Mbps Idle with WOL	4	64	6	141	244
	WOL disabled in driver	3	6	3	24	40
	WOL disabled in BIOS	3	6	3	24	40
	WOL disabled in BIOS w/FET switch‡	0	0	0	0	0

Note: The total solution power is the total amount of power from the 3.3V supply required for the 82567 to operate. In its mathematical form:
 solution power = (82567 current) * 3.3 V. The 3.3 V is assumed since this is the normal voltage rail provided to the LAN solution.

‡ Refer to Fig. 2 for details of the implementation of V3.3WOL gated by a FET switch controlled by an OR of WOL_EN and SLP_M#

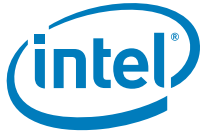

Table 7. Power Consumption—82567 with internal Voltage regulator, 1.9V (VCC1P8)

State	Mode	3.3 V Current [mA]	1.9 V Current [mA]	82567 Power [mW]	Solution Power [mW]
S0 - Max	1000Mbps Active, 90°C [Ta]	22	377	789	1317
	1000Mbps Idle, 90°C [Ta]	22	370	776	1294
S0 - Typ	1000Mbps Active	22	372	779	1300
	1000Mbps Idle	22	365	766	1277
	100Mbps Active	25	88	250	373
	100Mbps Idle	25	88	250	373
	10Mbps Active	4	113	228	386
	10Mbps Idle	4	64	135	224
	Cable Disconnect (ACBS)	3	16	40	63
	Cable Disconnect (82567V only, no ACBS)	3	30	67	109
	LAN Disable	3	9	27	40
SX	10Mbps Idle with WOL	4	64	135	224
	WOL disabled in driver	3	9	27	40
	WOL disabled in BIOS	3	9	27	40
	WOL disabled in BIOS w/FET switch‡	0	0	0	0

Note: The total solution power is the total amount of power from the 3.3V supply required for the 82567 to operate. In its mathematical form:
 solution power = (82567 current) * 3.3 V. The 3.3 V is assumed since this is the normal voltage rail provided to the LAN solution.

‡ Refer to Fig. 2 for details of the implementation of V3.3WOL gated by a FET switch controlled by an OR of WOL_EN and SLP_M#



Table 8. Power Consumption—82567 with external Voltage regulator; 1.8 V (VCC1P8)

State	Mode	3.3 V Current [mA]	1.8 V Current [mA]	1.05 V Current [mA]	82567 Power [mW]	Solution Power [mW]
S0 - Max	1000Mbps Active, 90°C [Ta]	22	253	115	643	1287
	1000Mbps Idle, 90°C [Ta]	22	253	110	638	1270
S0 - Typ	1000Mbps Active	22	251	112	636	1270
	1000Mbps Idle	22	251	106	630	1250
	100Mbps Active	25	71	18	228	376
	100Mbps Idle	25	71	18	228	376
	10Mbps Active	4	103	6	205	373
	10Mbps Idle	4	63	6	133	241
	Cable Disconnect (ACBS)	3	12	4	36	63
	Cable Disconnect (82567V only, no ACBS)	3	23	7	59	109
SX	LAN Disable	3	6	3	24	40
	10Mbps Idle with WOL	4	63	6	133	241
	WOL disabled in driver	3	6	3	24	40
	WOL disabled in BIOS	3	6	3	24	40
	WOL disabled in BIOS w/FET switch‡	0	0	0	0	0

Note: The total solution power is the total amount of power from the 3.3V supply required for the 82567 to operate. In its mathematical form:
 solution power = (82567 current) * 3.3 V. The 3.3 V is assumed since this is the normal voltage rail provided to the LAN solution.

‡ Refer to Fig. 2 for details of the implementation of V3.3WOL gated by a FET switch controlled by an OR of WOL_EN and SLP_M#

Table 9. Power Consumption—82567 with internal Voltage regulator, 1.8 V (VCC1P8)

State	Mode	3.3 V Current [mA]	1.8 V Current [mA]	82567 Power [mW]	Solution Power [mW]
S0 - Max	1000Mbps Active, 90 °C [Ta]	22	374	746	1307
	1000Mbps Idle, 90 °C [Ta]	22	368	735	1287
S0 - Typ	1000Mbps Active	22	369	737	1290
	1000Mbps Idle	22	362	724	1267
	100Mbps Active	25	86	237	366
	100Mbps Idle	25	87	239	370
	10Mbps Active	4	113	217	386
	10Mbps Idle	4	63	127	221
	Cable Disconnect (ACBS)	3	14	35	56
	Cable Disconnect (82567V only, no ACBS)	3	30	64	109
	LAN Disable	3	9	26	40
SX	10Mbps Idle with WOL	4	63	127	221
	WOL disabled in driver	3	9	26	40
	WOL disabled in BIOS	3	9	26	40
	WOL disabled in BIOS w/FET switch [‡]	0	0	0	0

Note: The total solution power is the total amount of power from the 3.3V supply required for the 82567 to operate. In its mathematical form:
 $\text{solution power} = (\text{82567 current}) * 3.3 \text{ V}$. The 3.3 V is assumed since this is the normal voltage rail provided to the LAN solution.

[‡] Refer to Fig. 2 for details of the implementation of V3.3WOL gated by a FET switch controlled by an OR of WOL_EN and SLP_M#

4.7 Power Delivery

The 82567 operates from two or three external power rails:

- A 3.3 V power rail for internal power regulation and for periphery.
- A 1.8 V-1.9 V power rail for analog functions. (See the *82567 Specification Update* for more information.)
- An optional 1.05 V power rail. Onboard transistor saved/unused when the on-die LVR is used.

4.7.1 The 1.8 V-1.9 V Rail

The power delivery system supports a load of 300 mA.

The 1.8 V-1.9 V rail is tunable and can be supplied in one of three ways:

- A discrete Switched Voltage Regulator (SVR) solution.
- An external power supply that is not dependent on support from 82567. For example, the platform designer might choose to route a platform-available 1.8 V-1.9 V supply to the 82567.
- A discrete LVR solution where the base current of PnP power transistor is driven by the 82567, while the power transistor is placed externally. 1.9 V is the default value.

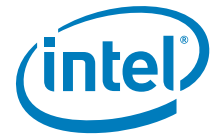

4.7.2 The 1.05 V Rail

The 1.05 V power delivery system supports a load of 300 mA.

The 1.05 V rail can be supplied in one of three ways:

- An external power supply that is not dependent on support from the 82567. For example, the platform designer might choose to route a platform-available 1.05 V supply to the 82567.
- A fully integrated on-die LVR solution.
- A discrete LVR solution, where the base current of PNP power transistor is driven by the 82567, while the power transistor is placed externally.
- A discrete Switched Voltage Regulator (SVR) solution.

4.7.3 Voltage Regulator Schematics

Schematics for 82567 power delivery using integrated and discrete LVRs are included in the reference schematics (titled *82567_Gigabit_Ethernet_PHY_Reference_Schematics*)

4.7.4 Voltage Regulator Power Supply Specifications

4.7.4.1 3.3 V Rail

Title	Description	Min	Max	Units
Rise Time	Time from 10% to 90% mark	1	100	ms
Monotonicity	Voltage dip allowed in ramp		0	mV
Slope	Ramp rate at any given time between 10% and 90%		28800	V/s
Operational Range	Voltage range for normal operating conditions	3	3.6	V
Ripple	Maximum voltage ripple @ BW = 50MHz		70	mV
Overshoot	Maximum voltage allowed		4	V
Capacitance	Minimum capacitance	25		uF

4.7.4.2 1.8 V-1.9 V Rail

Title	Description	Min	Max	Units
Rise Time	Time from 10% to 90% mark	1	100	ms
Monotonicity	Voltage dip allowed in ramp		0	mV
Slope	Ramp rate at any given time between 10% and 90%		1440	V/s
Operational Range	Voltage range for normal operating condtions	1.71	2.015	V
Ripple	Maximum voltage ripple @ BW = 50MHz		50	mV
Overshoot	Maximum voltage allowed		2.7	V
Output Capacitance	Capacitance range when using PNP circuit	20	40	uF

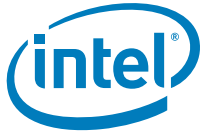

Title	Description	Min	Max	Units
Input Capacitance	Capacitance range when using PNP circuit	20		uF
Capacitance ESR	Equivalent series resistance of output capacitance	5	100	mΩ
Ictrl	Maximum output current rating rating to CTRL18		10	mA

Note: Do not use tantalum capacitors.

4.7.4.3 1.05 Rail

Title	Description	Min	Max	Units
Rise Time	Time from 10% to 90% mark	1	100	ms
Monotonicity	Voltage dip allowed in ramp		0	mV
Slope	Ramp rate at any given time between 10% and 90%		800	V/s
Operational Range	Voltage range for normal operating conditions	0.98	1.12	V
Ripple	Maximum voltage ripple @ BW = 50MHz		30	mV
Overshoot	Maximum voltage allowed		1.5	V
Output Capacitance	Capacitance range when using PNP circuit	20	40	uF
Input Capacitance	Capacitance range when using PNP circuit	20		uF
Capacitance ESR	Equivalent series resistance of output capacitance	5	100	mW
Ictrl	Maximum output current rating rating to CTRL10		10	mA

4.7.5 PNP Specifications

Title	Description	Min	Max	Units
VCBO		20		V
VCEO		20		V
IC(max)		1		A
IC(peak)		1.2		A
Ptot	Minimum total dissipated power @ 25°C ambient temperature	1.5		W
hFE	DC current gain @ Vce=-10V, Ic=500mA	85		
hfe	AC current gain @ Ic=50mA VCE=-10V, f=20MH	2.5		
Cc	Collector capacitance @ VCB=-5V, f=1MHz		50	pF
fT	Transition frequency @ Ic=10mA, VCE=-5V, f=100MHz	40		MHz
Recommended Transistor	BCP69			

Note: Maximum current of 1.8 V-1.9 V is less then 270mA, Maximum current of 1.05 V is less then 139mA. 1.8 V-1.9 V and 1.05 V PnP used is BCP69 (see BCP69 spec).



4.7.6 Power Sequencing

For proper and safe operation, the power supplies must follow the following rule:

$$VDDO (3.3 \text{ V}) \geq AVDD (1.8 \text{ V or } 1.9 \text{ V}) \geq DVDD (1.05 \text{ V})$$

This means that VDDO must start ramping before AVDD and DVDD, but DVDD may reach its nominal operating range before AVDD and VDDO.

Basically, the higher voltages must be greater than or equal to the lower voltages. This is necessary to avoid low impedance paths through clamping diodes and to eliminate back-powering.

The same requirements apply to the power-down sequence.

LAN_RST# must be low throughout the time that the power supplies are ramping. This will guarantee that the MAC and PHY reset cleanly. While LAN_RST# is low, PHYRST# will also be asserted to reset the PHY.

4.8 Timing Parameters

4.8.1 Timing Requirements

The 82567 requires the following start-up and power state transitions.

Table 10. Timing Requirements

Parameter	Description	Min	Max	Notes
T_{JRST_min}	Minimum duration of JRSTSYNC pulse	1 ms		Per LCI specification
T_{c2dud}	Completion of dock/undock configuration following cable connection		0.5 sec	
T_{r2init}	Completion of PHY configuration following a reset complete indication		0.5 sec	

4.8.2 Timing Guarantees

The 82567 guarantees the following start-up and power state transition related timing parameters.

Table 11. Timing Guarantees

Parameter	Description	Min	Max	Notes
T_{PHY_Reset}	Reset de-assertion to PHY reset complete		10 ms	PHY configuration should be delayed until PHY completes its reset
T_{XTAL}	XTAL frequency stable after platform power ramp up		5 ms	
T_{POR}	Internal POR trigger after XTAL stable		1 μ s	
T_{JKCLK}	JKCLK output stable after internal POR		3 μ s	
$T_{TX_IDLE-TO-DIFF-DATA}$	Maximum time to transition to valid TX specifications after leaving an electrical idle condition		200 ns	Required by GLCI 2.0 specification
$T_{RX_IDLE-TO-DIFF-DATA}$	Maximum time to be ready to accept data after leaving an electrical idle condition		200 ns	Required by GLCI 2.0 specification
T_{c2an}	Cable connect to start of auto negotiation	1.2 s	1.3 s	Per 802.3 specification

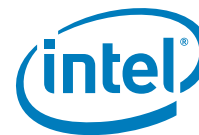

5.0 Package and Pinout Information

The physical characteristics of the 82567 are described in this section. The pin number to signal mapping is indicated in Section 5.4.

5.1 Package Information

The package used for the 82567 is an 56-pin QFN package. The Epad size is option number 4.

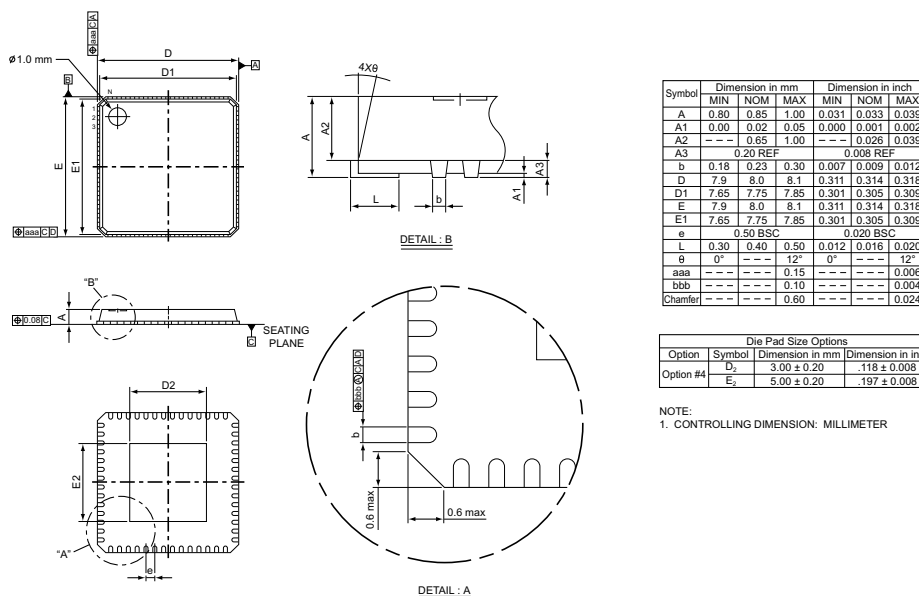

Figure 4. 82567 Mechanical Drawing

5.2 Thermal

The thermal resistance from junction to case, Jc, is 6.1 C/Watt. The thermal resistance from junction to ambient, J_a, is as follows:

Air Flow (m/s)	Maximum T _J	θ _{ja} (°C/Watt)
0	127.1	26.0
1	122.1	23.7
2	119.3	22.4
3	117.5	21.6

Note: No heat sink required.

Operating Ambient Temperature	
Minimum	Maximum
0 °C	85 °C

5.3 Internal Pull-Up Resistors

Table 12 lists the internal pull-up resistors and their functionality in different device states. Each internal pull-up resistor has a nominal value of 5 k Ω , ranging from 2.7 k Ω to 8.6 k Ω .

Table 12. Internal Pull-Up Resistors

Signal Name (Pin Location)	Default State	Power-Down State ¹
LED0 (4)	Not connected	Connected
LED1 (2)	Not connected	Connected
LED2 (1)	Not connected	Connected
JTAG_TCK (40)	Not connected	Connected
JTAG_TDI (7)	Connected	Connected
JTAG_TDO (6)	Not connected	Not Connected
JTAG_TMS (39)	Connected	Connected
JTXD[2:0] (42, 43, 44)	Not Connected	Not Connected
JRXD[2:0] (47, 48, 49)	Not Connected	Not Connected
LAN_DISABLE_N (37)	Connected	Connected

1. This column describes the state of the internal pull-up resistors in device power-down mode when the internal voltage regulators are shut down.



5.4 Visual Pin Assignments

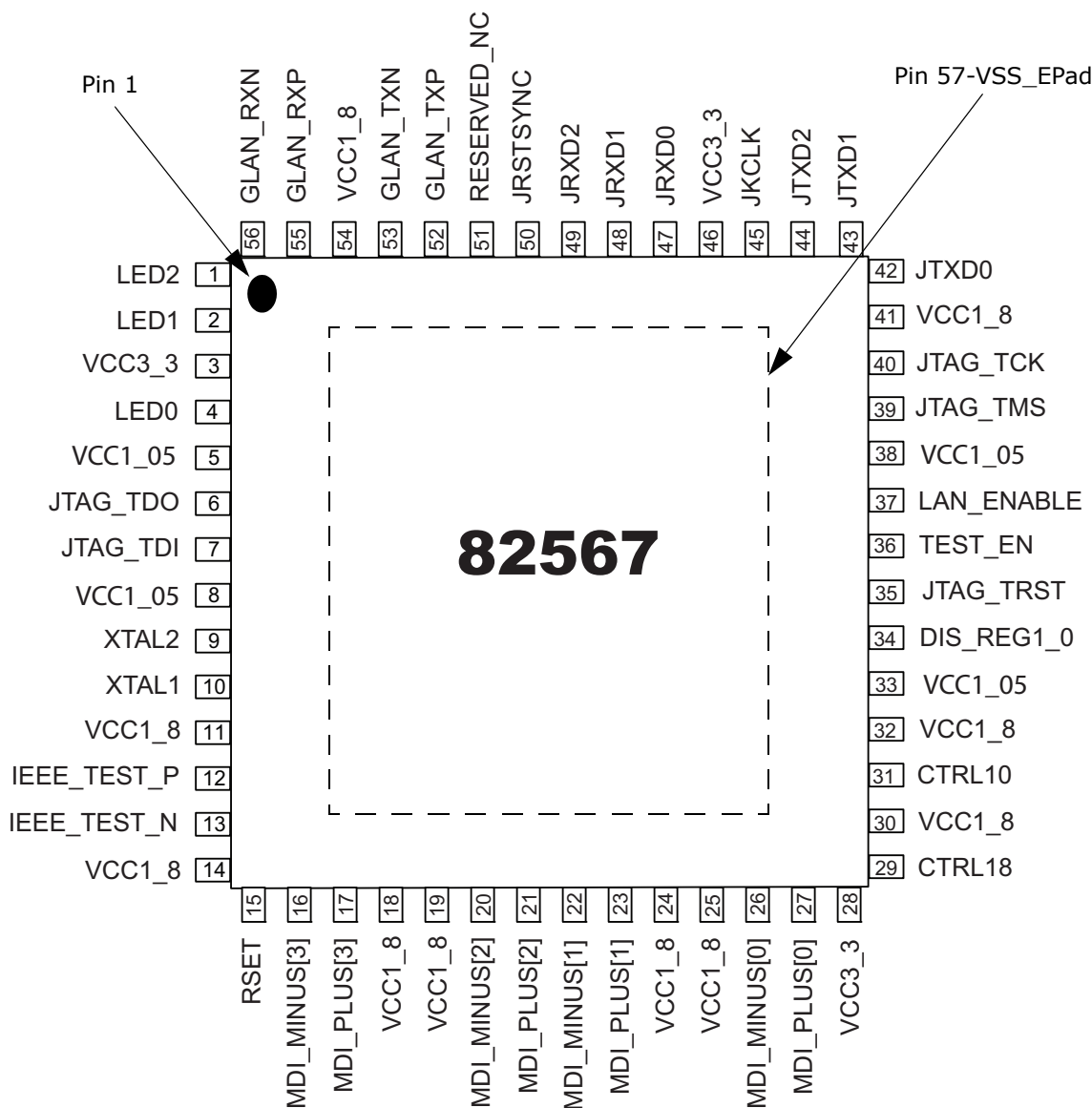

Note: VCC1_8 range is 1.71 V to 2.015 V
 VCC1_05 range is 0.98 V to 1.12 V

Figure 5. 82567 Pinout (Top View, Pins Down)



Table 13. Pin Mapping

Pin	Pin Name	Pin	Pin Name
1	LED2	29	CTRL18
2	LED1	30	VCC1_8
3	VCC3_3	31	CTRL10
4	LED0	32	VCC1_8
5	VCC1_05	33	VCC1_05
6	JTAG_TDO	34	REG_DIS1_0
7	JTAG_TDI	35	JTAG_TRST
8	VCC1_05	36	TEST_EN
9	XTAL2	37	LAN_DISABLE_N
10	XTAL1	38	VCC1_05
11	VCC1_8	39	JTAG_TMS
12	IEEE_TEST_P	40	JTAG_TCK
13	IEEE_TEST_N	41	VCC1_8
14	VCC1_8	42	JTXD0
15	RSET	43	JTXD1
16	MDI_MINUS[3]	44	JTXD2
17	MDI_PLUS[3]	45	JKCLK
18	VCC1_8	46	VCC3_3
19	VCC1_8	47	JRXD0
20	MDI_MINUS[2]	48	JRXD1
21	MDI_PLUS[2]	49	JRXD2
22	MDI_MINUS[1]	50	JRSTSYNC
23	MDI_PLUS[1]	51	RESERVED_NC
24	VCC1_8	52	GLAN_TXP
25	VCC1_8	53	GLAN_TXN
26	MDI_MINUS[0]	54	VCC1_8
27	MDI_PLUS[0]	55	GLAN_RXP
28	VCC3_3	56	GLAN_RXN

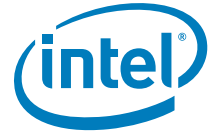

X-ON Electronics

Largest Supplier of Electrical and Electronic Components

Click to view similar products for [Ethernet ICs](#) category:

Click to view products by [Intel](#) manufacturer:

Other Similar products are found below :

[EZFM6324A S LKA5](#) [EZFM6364A S LKA7](#) [12200BS23MM](#) [EZFM5224A S LKA3](#) [VSC8522XJQ-02](#) [WGI219LM SLKJ3](#) [EZFM6348A S LKA6](#) [WGI219V SLKJ5](#) [BCM84793A1KFSBG](#) [BCM56680B1KFSBLG](#) [BCM53402A0KFSBG](#) [BCM56960B1KFSBG](#) [EZX557AT2 S LKVX](#) [BCM56842A1KFTBG](#) [BCM56450B1KFSBG](#) [EZX557AT S LKW4](#) [LAN9254-I/JRX](#) [RTL8211FS-CG](#) [RTL8153-VC-CG](#) [CH395L KTI225IT S LNNK](#) [KTI225IT S LNNL](#) [VSC8562XKS-14](#) [BCM56864A1IFSBG](#) [KSZ8462FHLLI](#) [LAN9303MI-AKZE](#) [KSZ8841-16MVLI](#) [KSZ8893MQL](#) [VSC8244XHG](#) [ADIN2111BCPZ](#) [ADIN2111CCPZ-R7](#) [FIDO2100BGA128IR0](#) [FIDO5210CBCZ](#) [FIDO5210BBCZ](#) [FIDO5110CBCZ](#) [FIDO5200CBCZ](#) [ADIN1110BCPZ](#) [ADIN1110CCPZ](#) [ADIN1100BCPZ](#) [ADIN1110CCPZ-R7](#) [ADIN1100CCPZ-R7](#) [ADIN1110BCPZ-R7](#) [DM9000EP](#) [DM9161AEP](#) [HG82567LM S LAVY](#) [LAN9210-ABZJ](#) [LAN9221-ABZJ](#) [LAN9221I-ABZJ](#) [LAN9211-ABZJ](#) [EZFM4105F897C S LKAM](#)