

J304, J305 N-Channel JFET

Features

- InterFET [N0026S Geometry](#)
- Low Noise: 4 nV/√Hz Typical
- Low Ciss: 4.3pF Typical
- Low Leakage: 10pA Typical
- RoHS Compliant
- SMT, TH, and Bare Die Package options.

Applications

- Mixers
- Oscillators
- VHF/UHF Amplifiers

Description

The -30V InterFET J304 and J305 are targeted for low noise low leakage VHF/UHF amplifier designs as well as mixers and oscillators. Gate leakages are typically less than 10pA at room temperatures.

SOT23 Top View

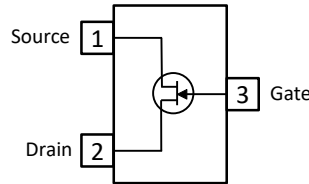

TO-92 Bottom View

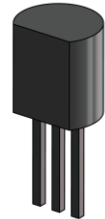
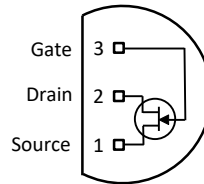

Product Summary

Parameters		J304 Min	J305 Min	Unit
BV _{GSS}	Gate to Source Breakdown Voltage	-30	-30	V
I _{DSS}	Drain to Source Saturation Current	5	1	mA
V _{GS(off)}	Gate to Source Cutoff Voltage	-2	-0.5	V
G _{FS}	Forward Transconductance	4500	3000	μS

Ordering Information Custom Part and Binning Options Available

Part Number	Description	Case	Packaging
J304; J305	Through-Hole	TO-92	Bulk
SMPJ304; SMPJ305	Surface Mount	SOT23	Bulk
SMPJ304TR; SMPJ305TR	7" Tape and Reel: Max 3,000 Pieces	SOT23	Minimum 1,000 Pieces Tape and Reel
	13" Tape and Reel: Max 9,000 Pieces		
J304COT; J305COT	Chip Orientated Tray (COT Waffle Pack)	COT	400/Waffle Pack
J304CFT; J305CFT	Chip Face-up Tray (CFT Waffle Pack)	CFT	400/Waffle Pack



Disclaimer: It is the Buyers responsibility for designing, validating and testing the end application under all field use cases and extreme use conditions. Guaranteeing the application meets required standards, regulatory compliance, and all safety and security requirements is the responsibility of the Buyer. These resources are subject to change without notice.

Electrical Characteristics

Maximum Ratings (@ T_A = 25°C, Unless otherwise specified)

Parameters	Value	Unit
V _{RGS} Reverse Gate Source and Gate Drain Voltage	-30	V
I _{FG} Continuous Forward Gate Current	10	mA
P _D Continuous Device Power Dissipation	360	mW
P Power Derating	3.27	mW/°C
T _J Operating Junction Temperature	-55 to 125	°C
T _{STG} Storage Temperature	-65 to 200	°C

Static Characteristics (@ T_A = 25°C, Unless otherwise specified)

Parameters	Conditions	J304			J305			Unit
		Min	Typ	Max	Min	Typ	Max	
V _{(BR)GSS} Gate to Source Breakdown Voltage	V _{DS} = 0V, I _G = -1μA	-30			-30			V
I _{GSS} Gate to Source Reverse Current	V _{GS} = -20V, V _{DS} = 0V			-100			-100	μA
V _{GS(OFF)} Gate to Source Cutoff Voltage	V _{DS} = 15V, I _D = 1nA	-2		-6	-0.5		-3	V
I _{DSS} Drain to Source Saturation Current	V _{GS} = 0V, V _{DS} = 15V (Pulsed)	5		15	1		8	mA

Dynamic Characteristics (@ T_A = 25°C, Unless otherwise specified)

Parameters	Conditions	J304			J305			Unit
		Min	Typ	Max	Min	Typ	Max	
G _{FS} Forward Transconductance	V _{DS} = 15V, V _{GS} = 0V, f = 1kHz	4500		7500	3000			μS
	V _{DS} = 15V, V _{GS} = 0V, f = 100MHz				3000			
	V _{DS} = 15V, V _{GS} = 0V, f = 400MHz		4200					
G _{OS} Output Conductance	V _{DS} = 15V, V _{GS} = 0V, f = 1kHz			50			50	μS
	V _{DS} = 15V, V _{GS} = 0V, f = 100MHz		60		60			
	V _{DS} = 15V, V _{GS} = 0V, f = 400MHz		80					
G _{IS} Input Conductance	V _{DS} = 15V, V _{GS} = 0V, f = 100MHz		80		80			μS
	V _{DS} = 15V, V _{GS} = 0V, f = 400MHz		800					
G _{PS} Power Gain	V _{DS} = 15V, I _D = 5mA, f = 100MHz		20					dB
	V _{DS} = 15V, I _D = 5mA, f = 400MHz		11					
B _{OS} Output Susceptance	V _{DS} = 15V, V _{GS} = 0V, f = 100MHz		800		800			μS
	V _{DS} = 15V, V _{GS} = 0V, f = 400MHz		3600					
B _{IS} Input Susceptance	V _{DS} = 15V, V _{GS} = 0V, f = 100MHz		2000		2000			μS
	V _{DS} = 15V, V _{GS} = 0V, f = 400MHz		7500					
C _{ISS} Input Capacitance	V _{DS} = 15V, V _{GS} = 0V, f = 1MHz		3		3			pF
C _{RSS} Reverse Transfer Capacitance	V _{DS} = 15V, V _{GS} = 0V, f = 1MHz		0.85		0.85			pF
C _{OSS} Output Capacitance	V _{DS} = 15V, V _{GS} = 0V, f = 1MHz		1		1			pF
NF Noise Figure	V _{DS} = 15V, I _D = 5mA, f = 100MHz		1.7					dB
	R _G = 1Ω, f = 400MHz		3.8					

SOT23 (TO-236AB) Mechanical and Layout Data

Package Outline Data



1. All linear dimensions are in millimeters.
2. Package weight approximately 0.12 grams
3. Molded plastic case UL 94V-0 rated
4. For Tape and Reel specifications refer to InterFET CTC-021 Tape and Reel Specification, Document number: IF39002
5. Bulk product is shipped in standard ESD shipping material
6. Refer to JEDEC standards for additional information.

Suggested Pad Layout

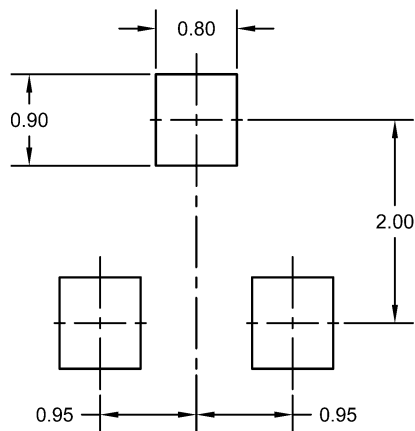

1. All linear dimensions are in millimeters.
2. The suggested land pattern dimensions have been provided for reference only. A more robust pattern may be desired for wave soldering.

TO-92 Mechanical and Layout Data

Package Outline Data

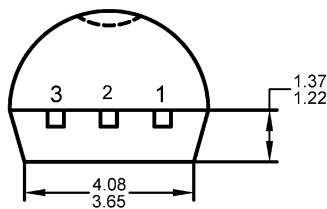
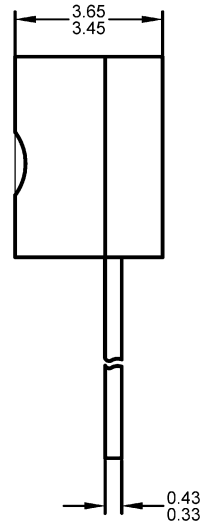
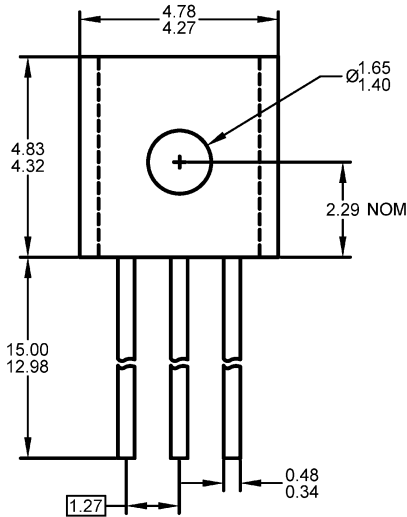

1. All linear dimensions are in millimeters.
2. Package weight approximately 0.19 grams
3. Molded plastic case UL 94V-0 rated
4. Bulk product is shipped in standard ESD shipping material
5. Refer to JEDEC standards for additional information.

Suggested Through-Hole Layout

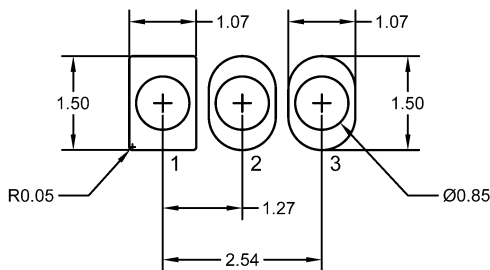

1. All linear dimensions are in millimeters.
2. The suggested land pattern dimensions have been provided as a straight lead reference only. A more robust pattern may be desired for wave soldering and/or bent lead configurations.

X-ON Electronics

Largest Supplier of Electrical and Electronic Components

Click to view similar products for [JFET](#) category:

Click to view products by [InterFET](#) manufacturer:

Other Similar products are found below :

[MCH3914-8-TL-H](#) [F5606](#) [2SK2394-6-TB-E](#) [CPH5901G-TL-E](#) [MCH3914-7-TL-H](#) [MCH5908H-TL-E](#) [CPH5902G-TL-E](#) [CPH5905G-TL-E](#)
[CPH5905H-TL-E](#) [2SK2394-7-TB-E](#) [NSVJ2394SA3T1G](#) [2N3819](#) [PN4393](#) [MMBFJ176](#) [2N4393](#) [U311](#) [2N5397](#) [2SK208-GR\(TE85L,F\)](#)
[MMBF4393LT1G](#) [J176_D74Z](#) [IF4500](#) [SMP4338](#) [SMP147](#) [SMP4117](#) [SMP5116](#) [SMPJ232](#) [SMPJ310](#) [SMPJ109](#) [SMP4856](#) [IF1330](#)
[SMPJ201](#) [SMP4340](#) [SMP5484](#) [IFN5566](#) [2N2609](#) [2N3821](#) [2N3823](#) [2N3970](#) [2N3971](#) [2N3972](#) [2N4091](#) [2N4092](#) [2N4093](#) [2N4118](#) [2N4118A](#)
[2N4220](#) [2N4221](#) [2N4221A](#) [2N4338](#) [2N4339](#)