

SPXO 3225 (163-B SERIES)

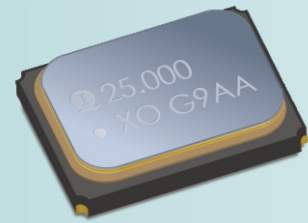

FEATURES

- Small size
- Low phase noise version available
- Low current consumption version available
- Conforms to AEC-Q100 (Optional)
- RoHS Compliant and Pb Free

Electrical Specifications

Parameters	Specifications
Output Waveform 输出波型	CMOS
Frequency Range 频率范围	32.768KHz 1MHz~50MHz 50MHz~160MHz
Supply Voltage Range (Vdd) 工作电压范围	1.0V~5V
Overall Frequency Stability 总频率偏差	±25ppm, ±30ppm, ±50ppm or specify
Operating Temperature Range 工作温度范围	-20°C~+70°C, -40°C~+85°C, -40°C~+125°C
Current Consumption (Idd) 消耗电流	100uA Max. 10mA Max.
Rise & Fall Time 上/下沿时间	20ns Max. 8ns Max. 3ns Max.
Output Symmetry 输出对称性	45%~55%
Output Voltage 输出电压	V _{OH} 90% VDD
	V _{OL} 10% VDD
Output Load 输出负载	15pF
Start-up Time 启动时间	10ms Max.
Storage Temperature Range 储存温度范围	-55°C~+125°C

** Inclusive of initial frequency tolerance at 25°C, operating temperature range, supply voltage change, load variation and 1st year aging.
包括在常温频率偏差, 工作温度范围的频率偏差, 首年老化率, 工作电压及负载变化造成的频率偏差。
Please consult our sales representatives for other specifications. 如对其他规格查询, 请与我司销售人员联系。

Dimensions

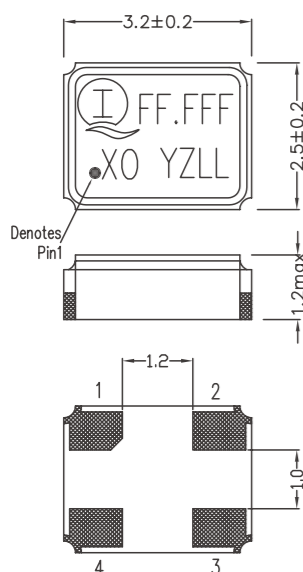

PIN CONNECTION

P/N	1631
1	Enable/Disable
2	GND
3	Output
4	VDD

DIMENSION (mm)

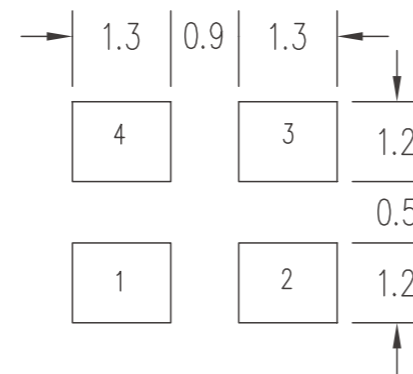

SOLDERING PATTERN (mm)

All specifications are subject to change without prior notice. 本公司保留修改规格的权利。

SPXO 3225 (163-E SERIES)

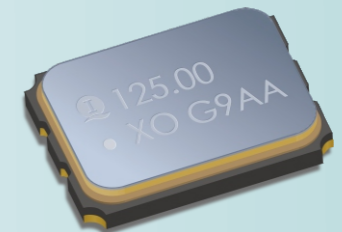

FEATURES

- Small size
- Excellent low phase noise and jitter
- Suitable for 5G Network terminal
- High Reliability and stability
- RoHS Compliant and Pb Free

Electrical Specifications

Parameters	Specifications
Output Waveform 输出波型	LVPECL
Frequency Range 频率范围	20MHz~200MHz
Supply Voltage Range (Vdd) 工作电压范围	2.5V~3.3V
Overall Frequency Stability 总频率偏差	±25ppm, ±30ppm or specify
Operating Temperature Range 工作温度范围	-20°C~+70°C, -40°C~+85°C
Current Consumption (Idd) 消耗电流	100mA Max.
Rise & Fall Time 上/下沿时间	1.5ns Max.
Output Symmetry 输出对称性	45%~55%
Output Voltage 输出电压	V _{OH} Vdd-1.025V Min. Vdd-0.88V Max.
	V _{OL} Vdd-1.81V Min. Vdd-1.62V Max.
Output Load 输出负载	50Ω to Vdd-2.0V
Start-up Time 启动时间	10ms Max.
Storage Temperature Range 储存温度范围	-55°C~+125°C

** Inclusive of initial frequency tolerance at 25°C, operating temperature range, supply voltage change, load variation and 1st year aging.
包括在常温频率偏差, 工作温度范围的频率偏差, 首年老化率, 工作电压及负载变化造成的频率偏差。
Please consult our sales representatives for other specifications. 如对其他规格查询, 请与我司销售人员联系。

Dimensions

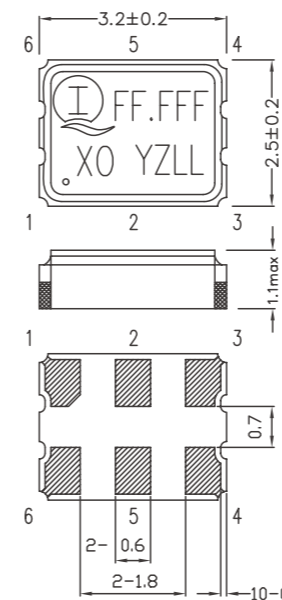

PIN CONNECTION

P/N	1631 LVPECL
1	Enable/Disable
2	N/C
3	GND
4	OUT
5	OUTN
6	VDD

DIMENSION (mm)

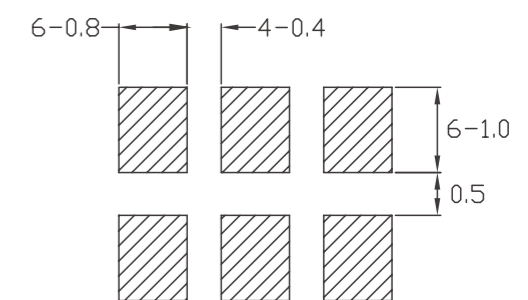

SOLDERING PATTERN (mm)

All specifications are subject to change without prior notice. 本公司保留修改规格的权利。

X-ON Electronics

Largest Supplier of Electrical and Electronic Components

Click to view similar products for [Standard Clock Oscillators](#) category:

Click to view products by [Interquip](#) manufacturer:

Other Similar products are found below :

[601252](#) [F335-25](#) [F535L-33.333](#) [F535L-50](#) [NBXHBA019LN1TAG](#) [SiT1602BI-22-33E-50.000000E](#) [SIT8918AA-11-33S-50.000000G](#)
[SM4420TEV-40.0M-T1K](#) [F335-24](#) [F335-40](#) [F535L-10](#) [F535L-12](#) [F535L-24](#) [F535L-27](#) [PE7744DW-100.0M](#) [ASF1-3.686MHZ-N-K-S](#) [ASV-](#)
[4.000MHZ-LCS-T](#) [XO57CTECNA3M6864](#) [601251](#) [SiT8503AI-18-33E-0.200000X](#) [SIT9122AI2C233E300.000000X](#) [9120AC-2D2-](#)
[33E212.500000](#) [9102AI-243N25E100.00000](#) [8208AC-82-18E-25.00000](#) [8008AI-72-XXE-24.545454E](#) [8004AC-13-33E-133.33000X](#) [AS-](#)
[4.9152-16-SMD-TR](#) [ASFL1-48.000MHZ-LC-T](#) [632L3I004M00000](#) [SIT8920AM-31-33E-25.0000](#) [DSC1028DI2-019.2000](#) [9121AC-2C3-](#)
[25E100.00000](#) [9102AI-233N33E100.00000X](#) [9102AI-233N25E200.00000](#) [9102AI-232H25S125.00000](#) [9102AI-133N25E200.00000](#) [9102AC-](#)
[283N25E200.00000](#) [9001AC-33-33E1-30.000](#) [8103AC-13-33E-12.00000X](#) [3921AI-2CF-33NZ125.000000](#) [5730-1SF](#) [XUN736000.032768I](#)
[ASV-25.000MHZ-ECS-50-T](#) [EC3925ETTTS-100.000M TR](#) [SIT1602BC-83-33E-10.000000Y](#) [8003AI-12-33S-40.00000Y](#) [1602BI-13-33S-](#)
[19.200000E](#) [8208AI-2F-18E-25.000000X](#) [8103AI-83-33E-33.00000X](#) [8208AI-8F-33E-66.666666X](#)