

ISL8272M

50A Digital DC/DC PMBus Power Module

FN8670
Rev.5.00
Nov 8, 2017

The [ISL8272M](#) is a 50A step-down PMBus compliant digital power module. Integrated in the module is a high performance digital PWM controller, dual-phase power MOSFETs, inductors, and the passives. This high efficiency power module is capable of delivering 50A without the need for airflow and heatsinks. The ISL8272M can be placed in a current sharing configuration with up to four modules in parallel to deliver 200A continuous current.

The ISL8272M operates with the ChargeMode™ control architecture, which responds to a transient load within a single switching cycle. The ISL8272M comes with operating in a pin strap mode; output voltage, switching frequency device, SMBus address, input UVLO, soft-start/stop, and current sharing can be programmed through external resistors. More configuration such as fault limits, fault response, margining, and sequencing can be easily programmed using the PMBus interface. PMBus can be used to monitor voltages, currents, temperatures, and fault status. The ISL8272M is supported by the PowerNavigator™ software, a graphical user interface (GUI) that can be used to configure modules to a desired solution.

The ISL8272M is built in a compact (18mmx23mmx7.5mm) and low profile overmolded HDA package, suitable for automated assembly by standard surface mount equipment.

Features

- Complete digital switch mode power supply
- Wide input voltage range: 4.5V to 14V
- Programmable output voltage range: 0.6V to 5V
- PMBus compliant communication interface
- Programmable V_{OUT}, margining, UV/OV, UC/OC, UT/OT, soft-start/stop, sequencing and external synchronization
- Monitor of V_{IN}, V_{OUT}, I_{OUT}, temperature, duty cycle, switching frequency, power-good, and faults
- Fast response ChargeMode control architecture
- Multiphase current sharing with up to four modules
- ±1.0% V_{OUT} accuracy over line, load, and temperature
- Internal nonvolatile memory and fault logging
- Thermally enhanced HDA package

Applications

- Server, telecom, storage, and datacom
- Industrial/ATE and networking equipment
- General purpose power for ASIC, FPGA, DSP, and memory

Related Literature

- For a full list of related documents, visit our website - [ISL8272M](#) product page

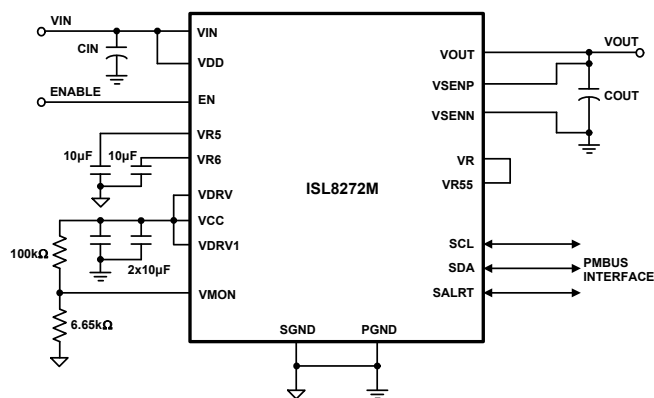

NOTE:
1. Figure 1 represents a typical implementation of the ISL8272M. For PMBus operation, it is recommended to tie the enable pin (EN) to SGND.

FIGURE 1. 50A APPLICATION CIRCUIT

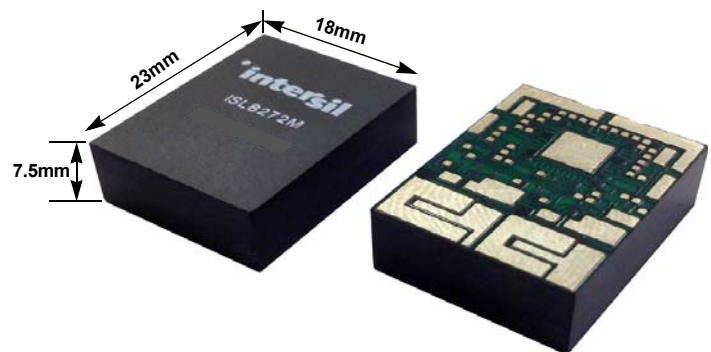

FIGURE 2. A SMALL PACKAGE FOR HIGH POWER DENSITY

Table of Contents

Ordering Information	3
Pin Configuration	4
Pin Descriptions	4
ISL8272M Internal Block Diagram	6
Typical Application Circuit - Single Module	7
Typical Application Circuit - Three Module Current Sharing	8
Absolute Maximum Ratings	10
Thermal Information	10
Recommended Operating Conditions	10
Electrical Specifications	10
Typical Performance Curves	13
Efficiency Performance	13
Transient Response Performance	14
Derating Curves	15
Functional Description	17
SMBus Communications	17
Output Voltage Selection	17
Soft-Start/Stop Delay and Ramp Times	17
Power-Good	18
Switching Frequency and PLL	18
Loop Compensation	19
Input Undervoltage Lockout (UVLO)	19
SMBus Module Address Selection	19
Output Overvoltage Protection	20
Output Prebias Protection	20
Output Overcurrent Protection	20
Thermal Overload Protection	21
Digital-DC Bus	21
Active Current Sharing	21
Phase Spreading	22
Fault Spreading	22
Output Sequencing	23
Monitoring with SMBus	23
Snapshot Parameter Capture	23
Nonvolatile Memory	23
Layout Guide	23
Thermal Considerations	24
Package Description	24
PCB Layout Pattern Design	24
Thermal Vias	24
Stencil Pattern Design	24
Reflow Parameters	24
PMBus Command Summary	25
PMBus Data Formats	28
PMBus Use Guidelines	29
Summary	29
PMBus Commands Description	29
Firmware Revision History	51
Revision History	51
About Intersil	52
Package Outline Drawing	53

Ordering Information

PART NUMBER (Notes 2, 3, 4)	PART MARKING	TEMP RANGE (°C)	PACKAGE (RoHS Compliant)	PKG. DWG. #
ISL8272MAIRZ	ISL8272M	-40 to +85	58 LD 18x23 HDA	Y58.18x23
ISL8272MBIRZ	ISL8272MB	-40 to +85	58 LD 18x23 HDA	Y58.18x23
ISL8272MEVAL1Z	Single-Module Evaluation Board (see UG003 , "ISL8272MEVAL1Z Evaluation Board User Guide")			
ISL8272MEVAL2Z	Three-Module Current Sharing Evaluation Board (see UG004 , "ISL8272MEVAL2Z Evaluation Board User Guide")			

NOTES:

- Add "-T" suffix for 100 unit tape and reel option. Refer to [TB347](#) for details on reel specifications.
- These Intersil Pb-free plastic packaged products are RoHS compliant by EU exemption 7C-I and 7A. They employ special Pb-free material sets; molding compounds/die attach materials and NiPdAu plate-e4 termination finish, which is compatible with both SnPb and Pb-free soldering operations. Intersil Pb-free products are MSL classified at Pb-free peak reflow temperatures that meet or exceed the Pb-free requirements of IPC/JEDEC J STD-020.
- For Moisture Sensitivity Level (MSL), refer to the [ISL8272M](#) product information page. For more information about MSL, refer to [TB363](#).

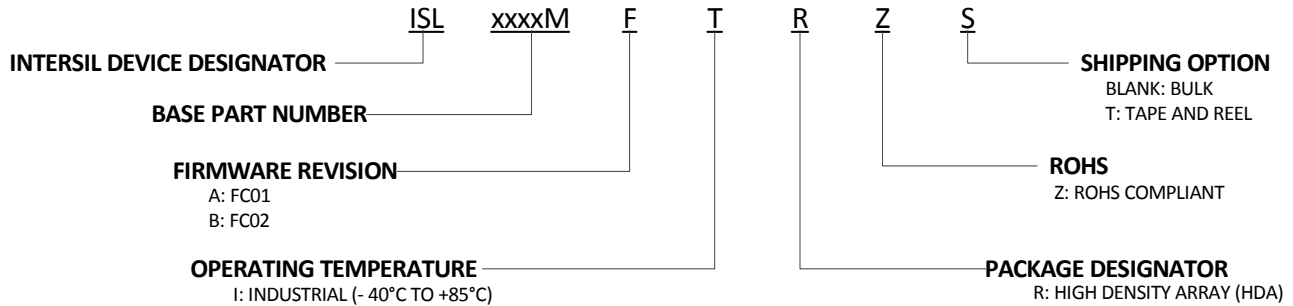

Pin Configuration

ISL8272M
(58 LD HDA)
TOP VIEW

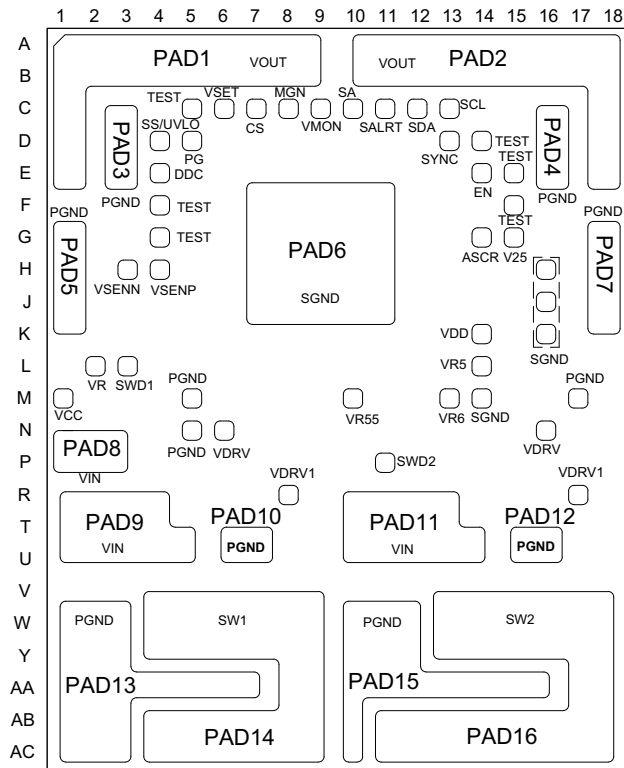

Pin Descriptions

PIN	LABEL	TYPE	DESCRIPTION
PAD1, 2	VOUT	PWR	Power supply output voltage. Output voltage from 0.6V to 5V. Tie these two pins together to achieve a single output. For higher output voltage, refer to the derating curves starting on page 15 to set the maximum output current from these pads.
PAD3, 4, 5, 7, 10, 12, 13, 15	PGND	PWR	Power ground. Refer to " Layout Guide " on page 23 for the PGND pad connections and I/O capacitor placement.
PAD6	SGND	PWR	Signal ground. Refer to " Layout Guide " on page 23 for the SGND pad connections.
PAD8, 9, 11	VIN	PWR	Input power supply voltage to power the module. Input voltage range from 4.5V to 14V.
PAD14, 16	SW1, SW2	PWR	Switching node pads. The SW pads dissipate the heat and provide good thermal performance. Refer to " Layout Guide " on page 23 for the SW pad connections.
C6	VSET	I	Output voltage selection pin. Used to set V_{OUT} set point and V_{OUT} max.
C7	CS	I	Current sharing configuration pin. Used to program current sharing configurations such as SYNC selection, phase spreading, and V_{OUT} droop.
C8	MGN	I	External V_{OUT} margin control pin. Active high (>2V) sets V_{OUT} margin high; active low (<0.8V) sets V_{OUT} margin low; high impedance (floating) sets V_{OUT} to normal voltage. Factory default range for margining is nominal V_{OUT} \pm 5%. When using PMBus to control margin command, leave this pin as no connection.
C9	VMON	I	Driver voltage monitoring. Use this pin to monitor VDRV through an external 16:1 resistor divider.
C10	SA	I	Serial address selection pin. Used to assign unique address for each individual device or to enable certain management features.
C11	SALRT	O	Serial alert. Connect to external host if desired. SALRT is asserted low upon a warning or a fault event and deasserted when warning or fault is cleared. A pull-up resistor is required.

Pin Descriptions (Continued)

PIN	LABEL	TYPE	DESCRIPTION
C12	SDA	I/O	Serial data. Connect to external host and/or to other Digital-DC™ devices. A pull-up resistor is required.
C13	SCL	I/O	Serial clock. Connect to external host and/or to other Digital-DC devices. A pull-up resistor is required.
D4	SS/ UVLO	I	Soft-start/stop and undervoltage lockout selection pin. Used to set turn on/off delay and ramp time as well as input UVLO threshold levels.
D5	PG	O	Power-good output. Power-good output can be an open drain that requires a pull-up resistor or push-pull output that can drive a logic input.
D13	SYNC	I/O	Clock synchronization input. Used to set the frequency of the internal switch clock, to sync to an external clock or to output internal clock.
E14	EN	I	Enable pin. Logic high to enable the module output.
E4	DDC	I/O	A Digital-DC bus. This dedicated bus provides the communication between devices for features such as sequencing, fault spreading and current sharing. The DDC pin on all Digital-DC devices should be connected together. A pull-up resistor is required.
C5, D14, E15, F4, F15, G4	TEST	-	Test pins. Do not connect these pins.
G14	ASCR	I	ChargeMode™ control ASCR parameters selection pin. Used to set ASCR gain and residual values.
G15	V25	PWR	Internal 2.5V reference used to power internal circuitry. No external capacitor required for this pin.
H3	VSENN	I	Differential output voltage sense feedback. Connect to negative output regulation point.
H4	VSENP	I	Differential output voltage sense feedback. Connect to positive output regulation point.
H16, J16, K16, M14	SGND	PWR	Signal grounds. Using multiple vias to connect the SGND pins to the internal SGND layer.
K14	VDD	PWR	Input supply voltage for controller. Connect VDD pad to V_{IN} supply.
L2	VR	PWR	Internal LDO bias pin. Tie VR to VR55 directly with a short loop trace.
L3, P11	SWD1, SWD2	PWR	Switching node driving pins. Directly connect to the SW1 and SW2 pads with short loop wires.
L14	VR5	PWR	Internal 5V reference used to power internal circuitry. Place a 10 μ F decoupling capacitor for this pin.
M1	VCC	PWR	Internal LDO output. Connect VCC to VDRV for internal LDO driving.
M5, M17, N5	PGND	PWR	Power grounds. Using multiple vias to connect the PGND pins to the internal PGND layer.
M10	VR55	PWR	Internal 5.5V bias voltage for internal LDO use only. Tie VR55 pin directly to VR pin.
M13	VR6	PWR	Internal 6V reference used to power internal circuitry. Place a 10 μ F decoupling capacitor for this pin.
N6, N16	VDRV	PWR	Power supply for internal FET drivers. Connect 10 μ F bypass capacitor to each of these pins. These pins can be driven by the internal LDO through VCC pin or by the external power supply directly. Keep the driving voltage between 4.5V and 5.5V. For 5V input application, use external supply or connect this pin to VIN.
R8, R17	VDRV1	I	Bias pin of the internal FET drivers. Always tie to VDRV.

ISL8272M Internal Block Diagram

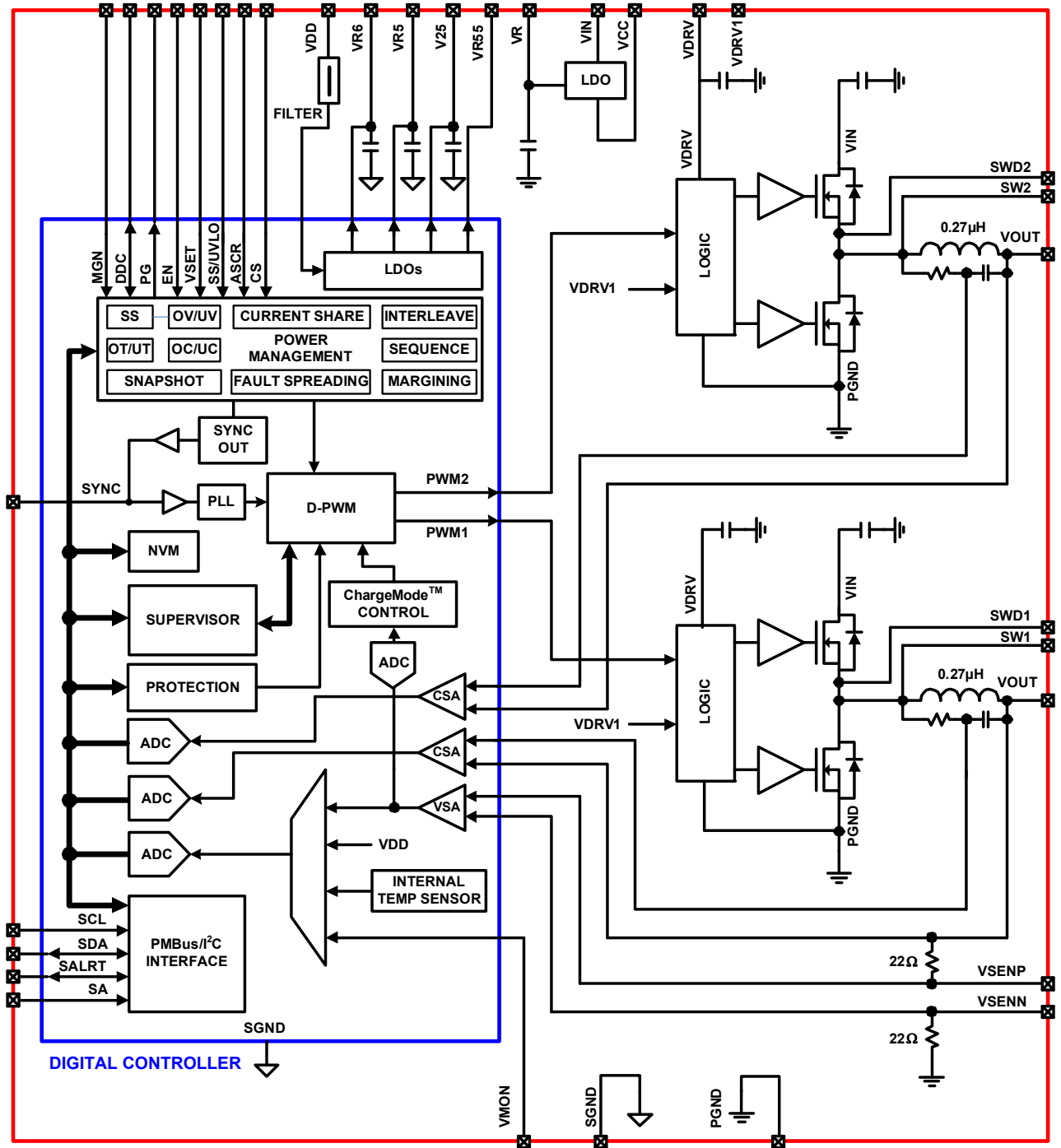
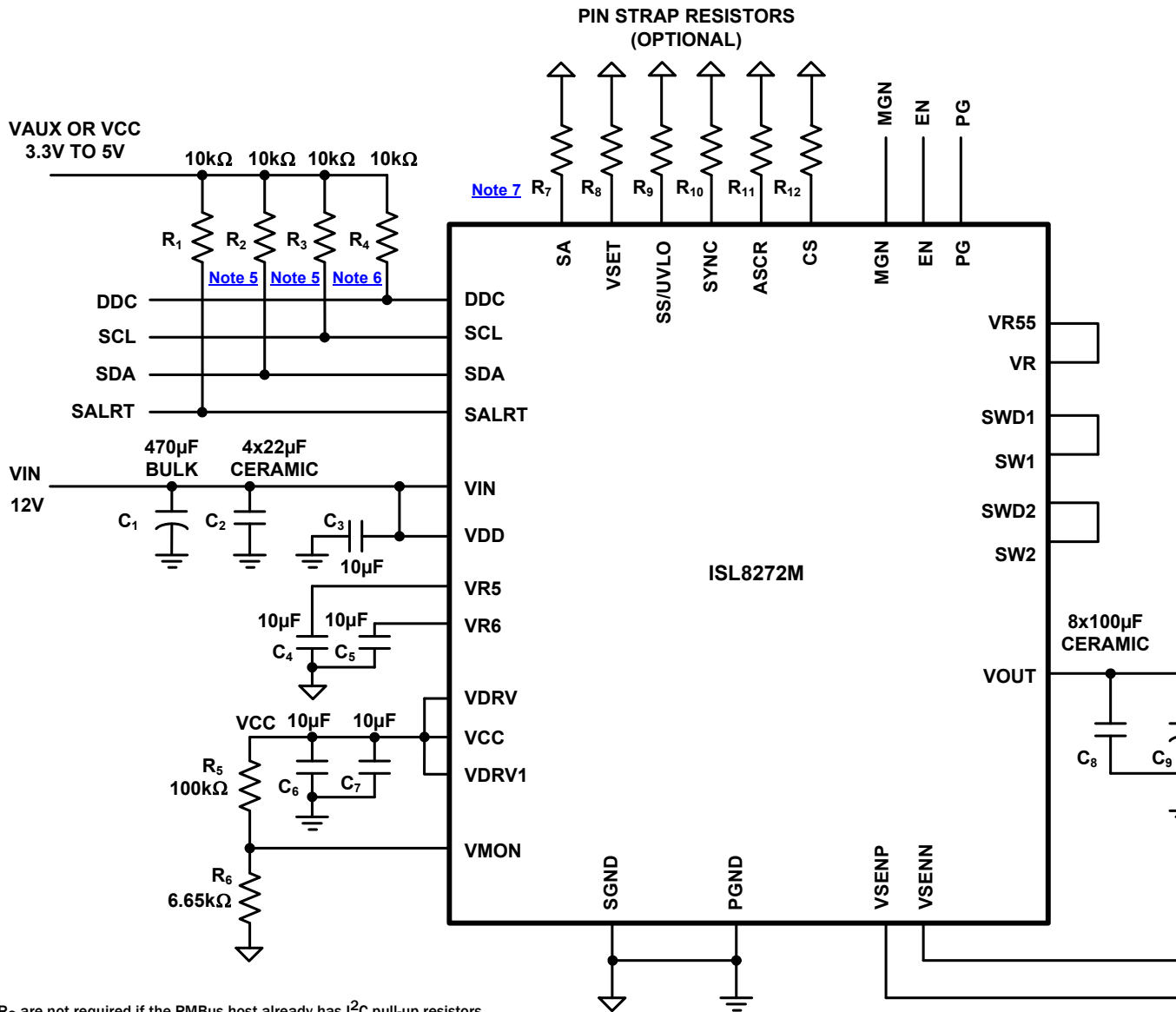

FIGURE 3. INTERNAL BLOCK DIAGRAM

Typical Application Circuit - Single Module



NOTES:

5. R₂ and R₃ are not required if the PMBus host already has I²C pull-up resistors.
6. Only one R₄ per DDC bus is required when multiple modules share the same DDC bus.
7. R₇ through R₁₂ can be selected according to the tables for the pin-strap resistor setting in this document.
If the PMBus configuration is chosen to overwrite the pin-strap configuration, R₈ through R₁₂ can be non-populated.
8. V₂₅, VR and VR55 do not need external capacitors. V₂₅ can be no connection.

FIGURE 4. TYPICAL APPLICATION CIRCUIT - SINGLE MODULE

Typical Application Circuit - Three Module Current Sharing

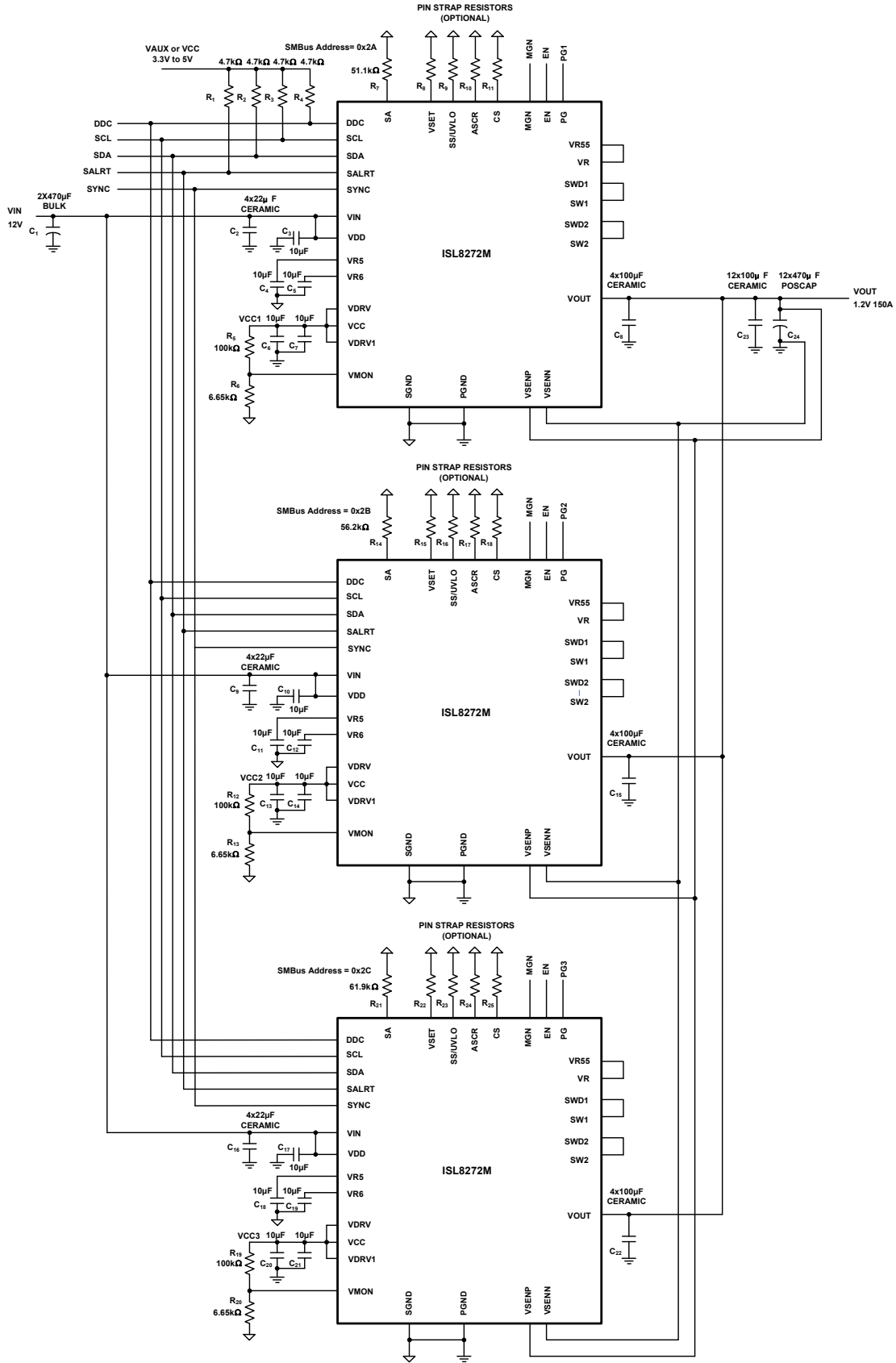

FIGURE 5. TYPICAL APPLICATION CIRCUIT - THREE MODULE CURRENT SHARING

TABLE 1. ISL8272M DESIGN GUIDE MATRIX AND OUTPUT VOLTAGE RESPONSE

V _{IN} (V)	V _{OUT} (V)	C _{IN} (BULK) (Note 9) (μF)	C _{IN} (CERAMIC) (μF)	C _{OUT} (BULK) (μF)	C _{OUT} (CERAMIC) (μF)	ASCR GAIN (Note 10)	ASCR RESIDUAL (Note 10)	P-P DEVIATION (mV)	RECOVERY TIME (μs)	LOAD STEP (A) (Note 11)	FREQ. (kHz)
5	1	1x470	6x47	4x470	12x100	220	90	50	20	0/25	300
5	1	1x470	4x47	4x470	8x100	550	100	45	15	0/25	533
12	1	1x470	6x22	4x470	12x100	220	90	55	22	0/25	300
12	1	1x470	4x22	4x470	8x100	550	100	50	15	0/25	533
5	1.8	1x470	6x47	4x470	8x100	200	90	60	25	0/25	300
5	1.8	1x470	4x47	2x470	6x100	250	90	70	20	0/25	533
12	1.8	1x470	6x22	4x470	8x100	220	90	70	20	0/25	300
12	1.8	1x470	4x22	2x470	6x100	280	100	70	20	0/25	533
5	2.5	1x470	6x47	2x470	6x100	120	90	100	30	0/25	300
5	2.5	1x470	4x47	2x470	4x100	250	90	80	20	0/25	533
12	2.5	1x470	6x22	2x470	6x100	110	90	100	20	0/25	300
12	2.5	1x470	4x22	2x470	4x100	220	90	100	15	0/25	533
5	3.3	1x470	6x47	2x470	4x100	100	90	120	50	0/25	300
5	3.3	1x470	4x47	2x470	4x100	220	90	100	30	0/25	533
12	3.3	1x470	4x22	2x470	4x100	220	90	100	10	0/25	533
12	5	1x470	6x22	2x470	4x100	230	90	120	10	0/25	533

NOTES:

9. C_{IN} bulk capacitor is optional only for energy buffer from the long input power supply cable.
10. ASCR gain and residual are selected to ensure phase margin higher than 60° and gain margin higher than 6dB at room temperature and full load (50A).
11. Output voltage response is tested with load step slew rate higher than 100A/μs.

TABLE 2. RECOMMENDED INPUT/OUTPUT CAPACITOR

VENDORS	VALUE	PART NUMBER
MURATA, Input Ceramic	47μF, 16V, 1210	GRM32ER61C476ME15L
MURATA, Input Ceramic	22μF, 16V, 1210	GRM32ER61E226KE15L
TAIYO YUDEN, Input Ceramic	47μF, 16V, 1210	EMK325BJ476MM-T
TAIYO YUDEN, Input Ceramic	22μF, 25V, 1210	TMK325BJ226MM-T
MURATA, Output Ceramic	100μF, 6.3V, 1210	GRM32ER60J107M
TDK, Output Ceramic	100μF, 6.3V, 1210	C3225X5R0J107M
AVX, Output Ceramic	100μF, 6.3V, 1210	12106D107MAT2A
SANYO POSCAP, Output Bulk	470μF, 4V	4TPE470MCL
SANYO POSCAP, Output Bulk	470μF, 6.3V	6TPF470MAH

Absolute Maximum Ratings

Input Supply Voltage, VIN Pin	-0.3V to 17V
Input Supply Voltage for Controller, VDD Pin	-0.3V to 17V
MOSFET Switch Node Voltage, SW1/2, SWD1/2	-0.3V to 17V
MOSFET Driver Supply Voltage, VDRV, VDRV1 Pin	-0.3V to 6.0V
Output Voltage, VOUT pin	-0.3V to 6.0V
Internal Reference Supply Voltage, VR6 Pin	-0.3V to 6.6V
Internal Reference Supply Voltage, VR, VR5, VR55 Pin	-0.3V to 6.5V
Internal Reference Supply Voltage, V25 Pin	-0.3V to 3V
Logic I/O Voltage for DDC, EN, MGN, PG, ASCR, CS SA, SCL, SDA, SALRT, SYNC, SS/UVLO, VMON, VSET	-0.3V to 6.0V
Analog Input Voltages for VSENP	-0.3V to 6.0V
VSENN	-0.3V to 0.3V
ESD Rating Human Body Model (Tested per JESD22-A114F)	2000V
Machine Model (Tested per JESD22-A115C)	200V
Charged Device Model (Tested per JESD22-C110D)	750V
Latch-Up (Tested per JESD78C; Class 2, Level A)	100mA

CAUTION: Do not operate at or near the maximum ratings listed for extended periods of time. Exposure to such conditions may adversely impact product reliability and result in failures not covered by warranty.

NOTES:

- θ_{JA} is measured in free air with the module mounted on an 6-layer evaluation board 4.7x4.8inch in size with 2oz surface and 2oz buried planes and multiple via interconnects as specified in the ISL8272MEVAL1Z Evaluation Board User Guide.
- For θ_{JC} , the “case temp” location is the center of the package underside.

Thermal Information

Thermal Resistance (Typical)	θ_{JA} (°C/W)	θ_{JC} (°C/W)
58 LD HDA Package (Notes 12, 13)	6.55	1.6
Maximum Junction Temperature (Plastic Package)	+125°C	
Storage Temperature Range	-55°C to +150°C	
Pb-Free Reflow Profile	Refer to Figure 30	

Recommended Operating Conditions

Input Supply Voltage Range, VIN	4.5V to 14V
Input Supply Voltage Range for Controller, VDD	4.5V to 14V
Output Voltage Range, VOUT	0.6V to 5V
Output Current Range, IOUT(DC) (Note 16)	0A to 50A
Operating Junction Temperature Range, TJ	-40°C to +125°C

Electrical Specifications VIN = VDD = 12V, fSW = 533kHz, TA = -40°C to +85°C, unless otherwise noted. Typical values are at TA = +25°C. **Boldface limits apply across the operating temperature range, -40°C to +85°C.**

SYMBOL	PARAMETER	TEST CONDITIONS	MIN (Note 14)	TYP	MAX (Note 14)	UNITS
INPUT AND SUPPLY CHARACTERISTICS						
IDD	Input Supply Current for Controller	VIN = VDD = 12V, VOUT = 0V, module not enabled		40	50	mA
VR6	6V Internal Reference Supply Voltage		5.5	6.1	6.6	V
VR5	5V Internal Reference Supply	I _{VR5} < 5mA	4.5	5.2	5.5	V
V25	2.5V Internal Reference Supply		2.25	2.5	2.75	V
VCC	Internal LDO Output Voltage			5.3		V
I _{VCC}	Internal LDO Output Current	VIN = VDD = 12V, VCC connected to VDRV, module enabled	50			mA
VDD_READ_RES	Input Supply Voltage for Controller Read Back Resolution			10		Bits
VDD_READ_ERR	Input Supply Voltage for Controller Read Back Total Error (Note 17)	PMBus Read		±2		%FS
OUTPUT CHARACTERISTICS						
VOUT_RANGE	Output Voltage Adjustment Range	VIN > VOUT + 1.8V	0.54		5.5	V
VOUT_RES	Output Voltage Set-Point Range	Configured using PMBus		±0.025		%
VOUT_ACCY	Output Voltage Set-Point Accuracy (Notes 15, 17)	Includes line, load and temperature (-20°C ≤ TA ≤ +85°C)	-1		+1	%VOUT
VOUT_READ_RES	Output Voltage Read Back Resolution			10		Bits
VOUT_READ_ERR	Output Voltage Read Back Total Error (Note 17)	PMBus read	-2		+2	%VOUT
IOUT_READ_RES	Output Current Read Back Resolution			10		Bits

Electrical Specifications $V_{IN} = V_{DD} = 12V$, $f_{SW} = 533kHz$, $T_A = -40^\circ C$ to $+85^\circ C$, unless otherwise noted. Typical values are at $T_A = +25^\circ C$. **Boldface limits apply across the operating temperature range, $-40^\circ C$ to $+85^\circ C$.** (Continued)

SYMBOL	PARAMETER	TEST CONDITIONS	MIN (Note 14)	TYP	MAX (Note 14)	UNITS
I _{OUT_RANGE}	Output Current Range (Note 16)				50	A
I _{OUT_READ_ERR}	Output Current Read back Total Error	PMBus read at max load. V _{OUT} = 1V		±3		A
SOFT-START AND SEQUENCING						
t _{ON_DELAY}	Delay Time From Enable to V _{OUT} Rise	Configured using PMBus	2		5000	ms
t _{ON_DELAY_ACCY}	t _{ON_DELAY} Accuracy			±2		ms
t _{ON_RISE}	Output Voltage Ramp-Up Time	Configured using PMBus. Single module standalone	0.5		100	ms
t _{ON_RISE_ACCY}	Output Voltage Ramp-Up Time Accuracy	Single module standalone		±250		µs
t _{OFF_DELAY}	Delay Time From disable to V _{OUT} Fall	Configured using PMBus	2		5000	ms
t _{OFF_DELAY_ACCY}	t _{OFF_DELAY} Accuracy			±2		ms
t _{OFF_FALL}	Output Voltage Fall Time	Configured using PMBus. Single module standalone	0.5		100	ms
t _{ON_FALL_ACCY}	Output Voltage Fall Time Accuracy	Single module standalone		±250		µs
POWER-GOOD						
V _{PG_DELAY}	Power-Good Delay	Configured using PMBus	0		5000	ms
TEMPERATURE SENSE						
T _{SENSE_RANGE}	Temperature Sense Range	Configurable using PMBus	-50		150	°C
INT_TEMP _{ACCY}	Internal Temperature Sensor Accuracy	Tested at +100 °C	-5		+5	°C
FAULT PROTECTION						
V _{DD_UVLO_RANGE}	V _{DD} Undervoltage Threshold Range	Measured internally	4.18		16	V
V _{DD_UVLO_ACCY}	V _{DD} Undervoltage Threshold Accuracy (Note 17)			±2		%FS
V _{DD_UVLO_DELAY}	V _{DD} Undervoltage Response Time			10		µs
V _{OUT_OV_RANGE}	V _{OUT} Overvoltage Threshold Range	Factory default		1.15V _{OUT}		V
		Configured using PMBus	1.05V_{OUT}		V_{OUT_MAX}	V
V _{OUT_UV_RANGE}	V _{OUT} Undervoltage Threshold Range	Factory default		0.85V _{OUT}		V
		Configured using PMBus	0		0.95V_{OUT}	V
V _{OUT_OV/UV_ACCY}	V _{OUT} OV/UV Threshold Accuracy (Note 15)		-2		+2	%
V _{OUT_OV/UV_DELAY}	V _{OUT} OV/UV Response Time			10		µs
I _{LIMIT_ACCY}	Output Current Limit Set-Point Accuracy (Note 17)	Tested at I _{OUT_OC_FAULT_LIMIT} = 50A		±10		% FS
I _{LIMIT_DELAY}	Output Current Fault Response Time (Note 18)	Factory default		3		t _{sw}
T _{JUNCTION}	Over-temperature Protection Threshold (Controller Junction Temperature)	Factory default		125		°C
		Configured using PMBus	-40		125	°C
T _{JUNCTION_HYS}	Thermal Protection Hysteresis			15		°C

Electrical Specifications $V_{IN} = V_{DD} = 12V$, $f_{SW} = 533kHz$, $T_A = -40^\circ C$ to $+85^\circ C$, unless otherwise noted. Typical values are at $T_A = +25^\circ C$. **Boldface limits apply across the operating temperature range, $-40^\circ C$ to $+85^\circ C$.** (Continued)

SYMBOL	PARAMETER	TEST CONDITIONS	MIN (Note 14)	TYP	MAX (Note 14)	UNITS
OSCILLATOR AND SWITCHING CHARACTERISTICS						
f_{SW_RANGE}	Switching Frequency Range		296		1067	kHz
f_{SW_ACCY}	Switching Frequency Set-Point Accuracy		-5		+5	%
EXT_SYNC _{PW}	Minimum Pulse Width Required from External SYNC Clock	Measured at 50% amplitude	150			ns
EXT_SYNC _{DRIFT}	Drift Tolerance for External SYNC Clock	External SYNC Clock equal to 500kHz is not supported	-10		+10	%
LOGIC INPUT/OUTPUT CHARACTERISTICS						
I_{LOGIC_BIAS}	Bias Current at the Logic Input Pins	DDC, EN, MGN, PG, SA, SCL, SDA, SALRT, SYNC, UVLO, V_{MON} , V_{SET}	-100		+100	nA
$V_{LOGIC_IN_LOW}$	Logic Input Low Threshold Voltage				0.8	V
$V_{LOGIC_IN_HIGH}$	Logic Input High Threshold Voltage		2.0			V
$V_{LOGIC_OUT_LOW}$	Logic Output Low Threshold Voltage	2mA sinking			0.5	V
$V_{LOGIC_OUT_HIGH}$	Logic Output High Threshold Voltage	2mA sourcing	2.25			V
PMBus INTERFACE TIMING CHARACTERISTIC						
f_{SMB}	PMBus Operating Frequency		100		400	kHz

NOTES:

14. Compliance to datasheet limits is assured by one or more methods: Production test, characterization and/or design. Controller is independently tested before module assembly.
15. V_{OUT} measured at the termination of the VSENP and VSENN sense points.
16. The MAX load current is determined by the thermal "[Derating Curves](#)" on page 15 provided with this document.
17. "FS" stands for full scale of recommended maximum operation range.
18. " t_{SW} " stands for time period of operation switching frequency.

Typical Performance Curves

Efficiency Performance Operating condition: $T_A = +25^\circ\text{C}$, no air flow. $C_{OUT} = 1340\mu\text{F}$. Typical values are used unless otherwise noted.

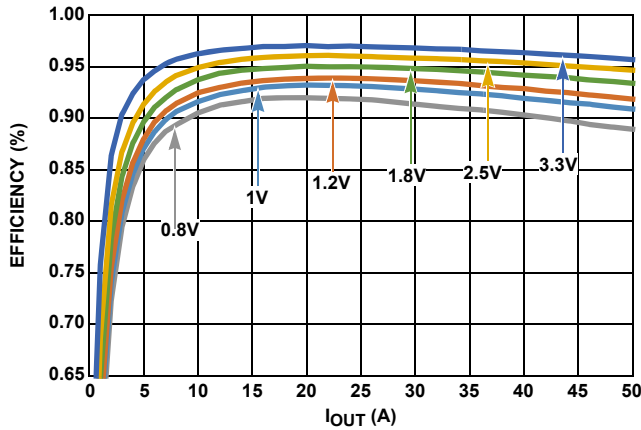

FIGURE 6. EFFICIENCY vs OUTPUT CURRENT AT $V_{IN} = 5\text{V}$, $f_{SW} = 300\text{kHz}$ FOR VARIOUS OUTPUT VOLTAGES

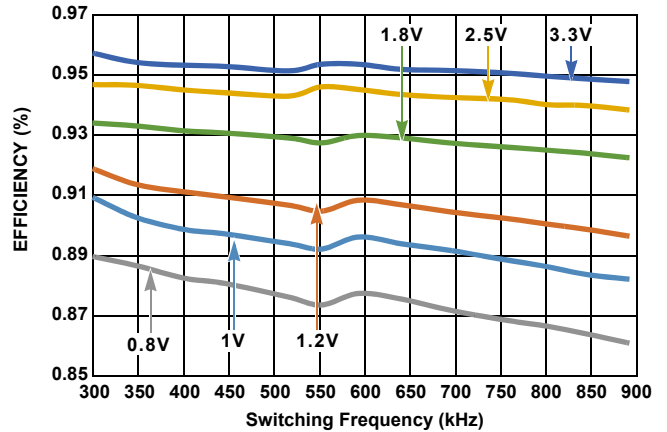

FIGURE 7. EFFICIENCY vs SWITCHING FREQUENCY AT $V_{IN} = 5\text{V}$, $I_{OUT} = 50\text{A}$ FOR VARIOUS OUTPUT VOLTAGES

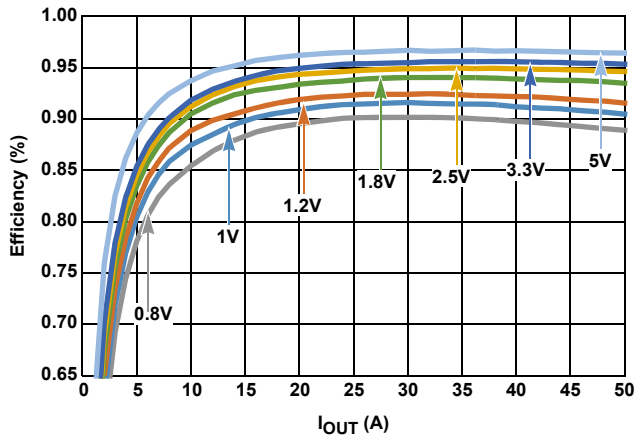

FIGURE 8. EFFICIENCY vs OUTPUT CURRENT AT $V_{IN} = 9\text{V}$, $f_{SW} = 300\text{kHz}$ FOR VARIOUS OUTPUT VOLTAGES

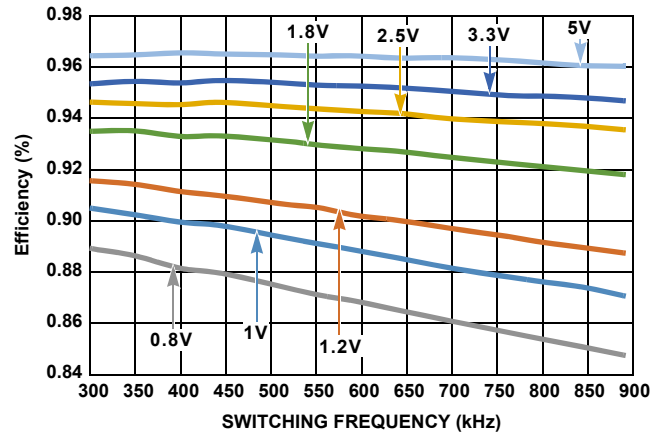

FIGURE 9. EFFICIENCY vs SWITCHING FREQUENCY AT $V_{IN} = 9\text{V}$, $I_{OUT} = 50\text{A}$ FOR VARIOUS OUTPUT VOLTAGES

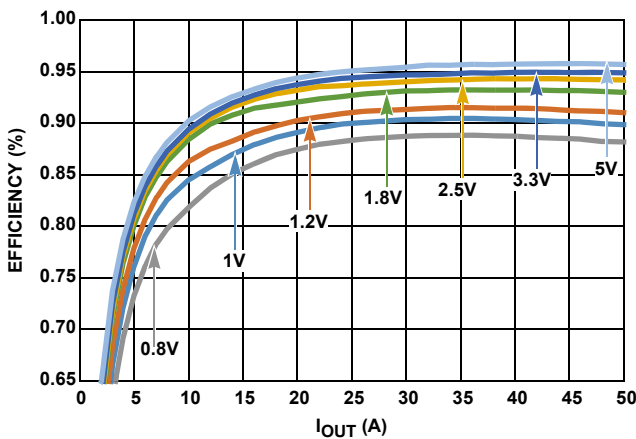

FIGURE 10. EFFICIENCY vs OUTPUT CURRENT AT $V_{IN} = 12\text{V}$, $f_{SW} = 300\text{kHz}$ FOR VARIOUS OUTPUT VOLTAGES

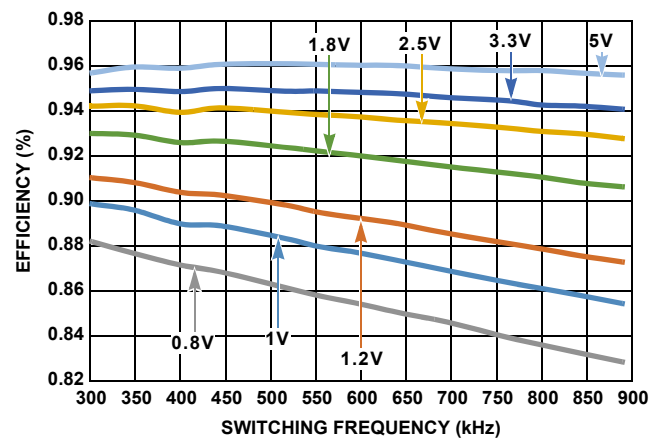

FIGURE 11. EFFICIENCY vs SWITCHING FREQUENCY AT $V_{IN} = 12\text{V}$, $I_{OUT} = 50\text{A}$ FOR VARIOUS OUTPUT VOLTAGES

Typical Performance Curves (Continued)

Transient Response Performance Operating condition: $V_{IN} = 12V$, $f_{SW} = 533kHz$, $I_{OUT} = 0A/25A$, I_{OUT} slew rate $> 100A/\mu s$, $T_A = +25^\circ C$, no air flow. Typical values are used unless otherwise noted.

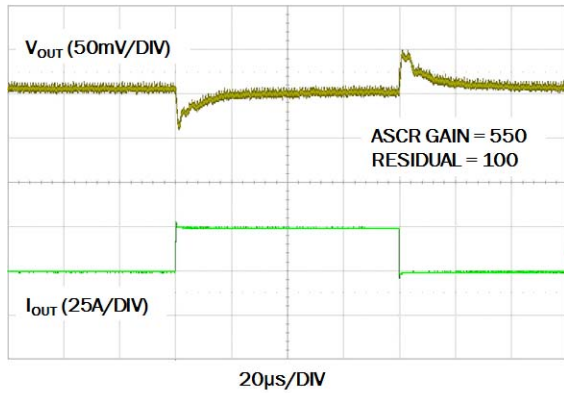

FIGURE 12. 1V TRANSIENT RESPONSE. $C_{OUT} = 8 \times 100\mu F$ CERAMIC + $4 \times 470\mu F$ POSCAP

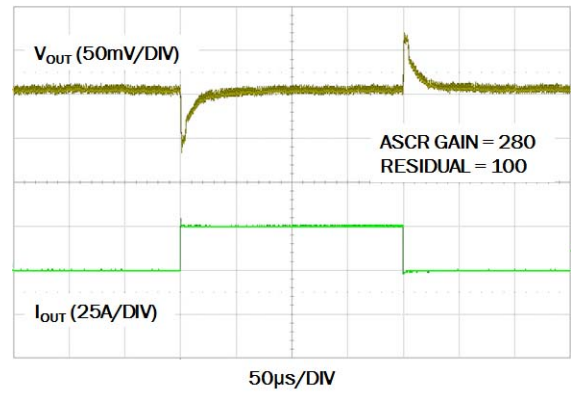

FIGURE 13. 1.8V TRANSIENT RESPONSE. $C_{OUT} = 6 \times 100\mu F$ CERAMIC + $2 \times 470\mu F$ POSCAP

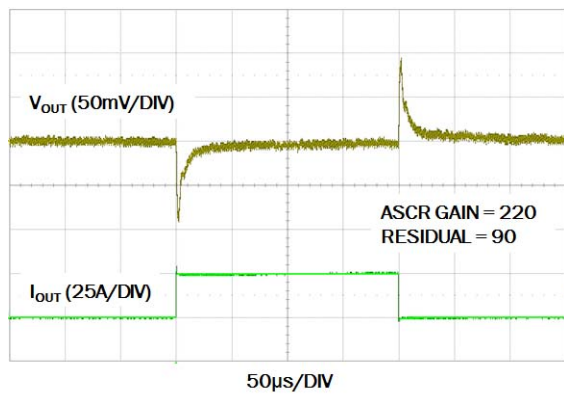

FIGURE 14. 2.5V TRANSIENT RESPONSE. $C_{OUT} = 4 \times 100\mu F$ CERAMIC + $2 \times 470\mu F$ POSCAP

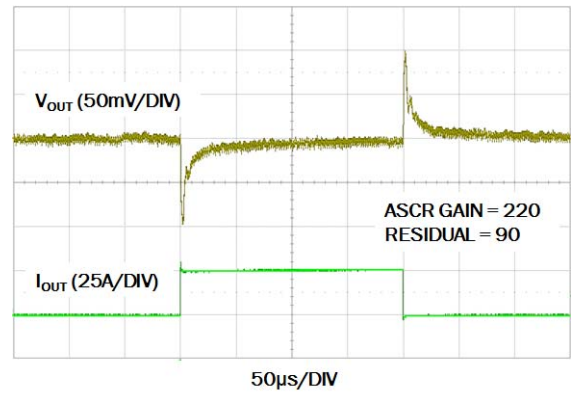

FIGURE 15. 3.3V TRANSIENT RESPONSE. $C_{OUT} = 4 \times 100\mu F$ CERAMIC + $2 \times 470\mu F$ POSCAP

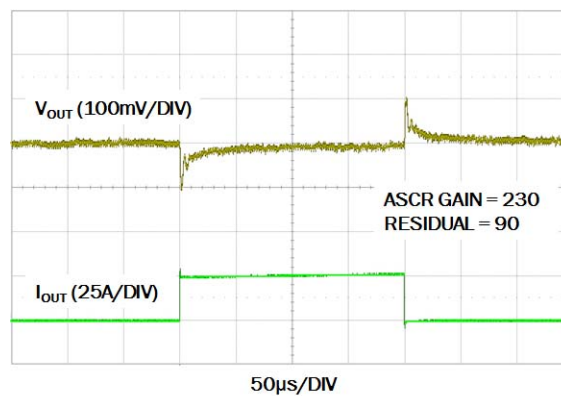

FIGURE 16. 5V TRANSIENT RESPONSE. $C_{OUT} = 4 \times 100\mu F$ CERAMIC + $2 \times 470\mu F$ POSCAP

Typical Performance Curves (Continued)

Derating Curves All of the following curves were plotted at $T_J = +115^\circ\text{C}$.

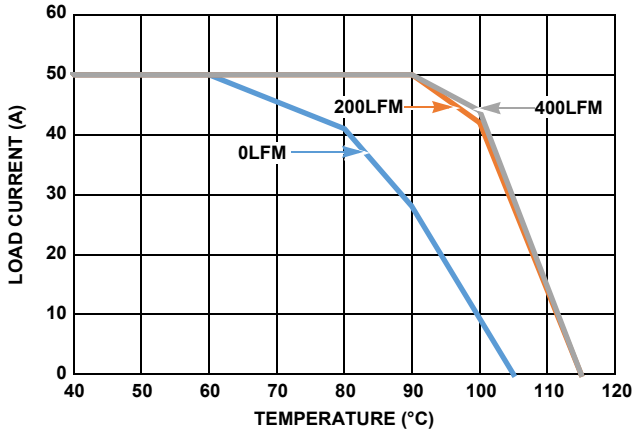

FIGURE 17. $5V_{IN}$ TO $1V_{OUT}$, $f_{SW} = 300\text{kHz}$

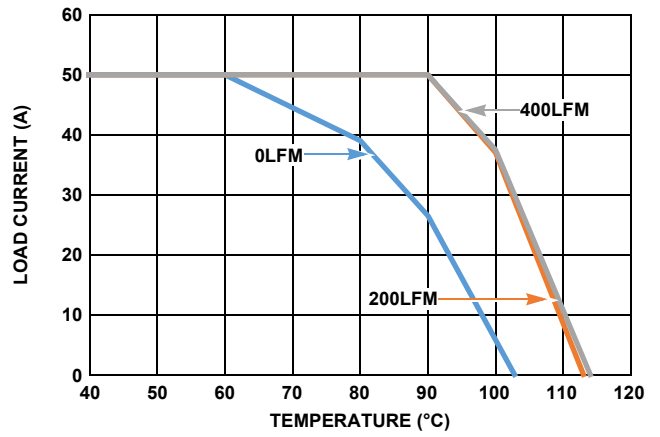

FIGURE 18. $12V_{IN}$ TO $1V_{OUT}$, $f_{SW} = 300\text{kHz}$

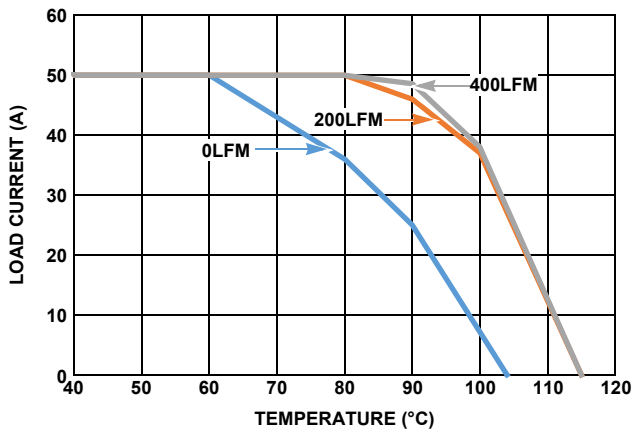

FIGURE 19. $5V_{IN}$ TO $1.8V_{OUT}$, $f_{SW} = 300\text{kHz}$

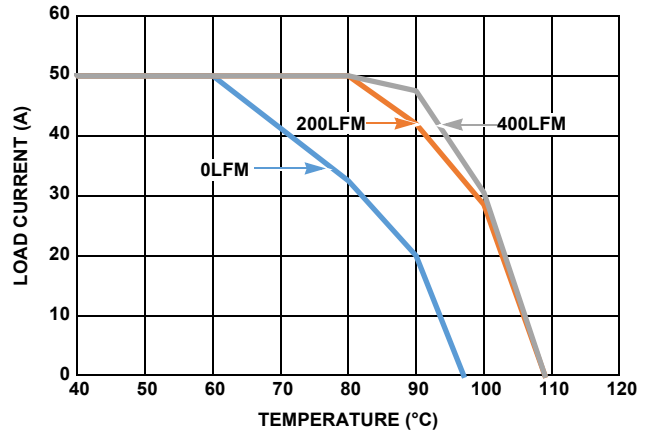

FIGURE 20. $12V_{IN}$ TO $1.8V_{OUT}$, $f_{SW} = 300\text{kHz}$

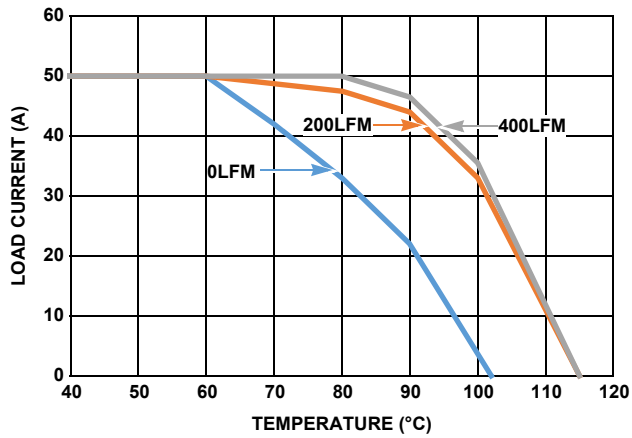

FIGURE 21. $5V_{IN}$ TO $2.5V_{OUT}$, $f_{SW} = 300\text{kHz}$

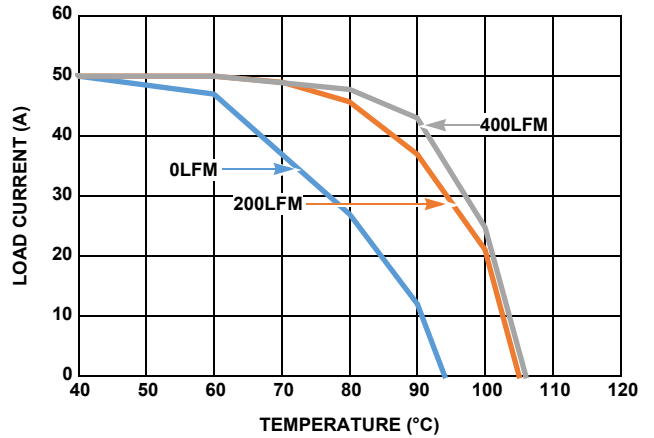

FIGURE 22. $12V_{IN}$ TO $2.5V_{OUT}$, $f_{SW} = 300\text{kHz}$

Typical Performance Curves (Continued)

Derating Curves

All of the following curves were plotted at $T_J = +115^\circ\text{C}$.

The READ_INTERNAL_TEMP command value in the PowerNavigator™ software is the temperature reading value of the internal controller.

The junction temperature of the power stage in the module may be higher than the READ_INTERNAL_TEMP command value. The temperature difference depends on the operating conditions; in some extreme cases, the junction temperature of the power stage can be 30 °C higher than the READ_INTERNAL_TEMP command value.

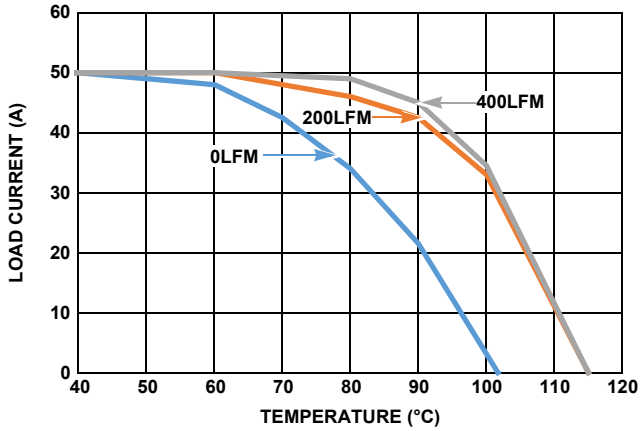

FIGURE 23. 5V_{IN} TO 3.3V_{OUT}, f_{SW} = 300kHz

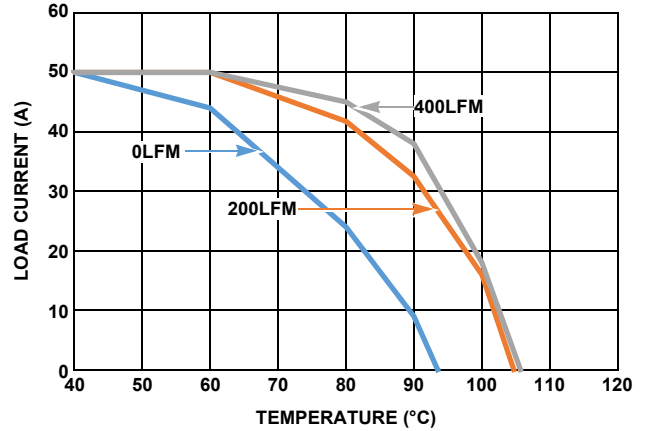

FIGURE 24. 12V_{IN} TO 3.3V_{OUT}, f_{SW} = 533kHz

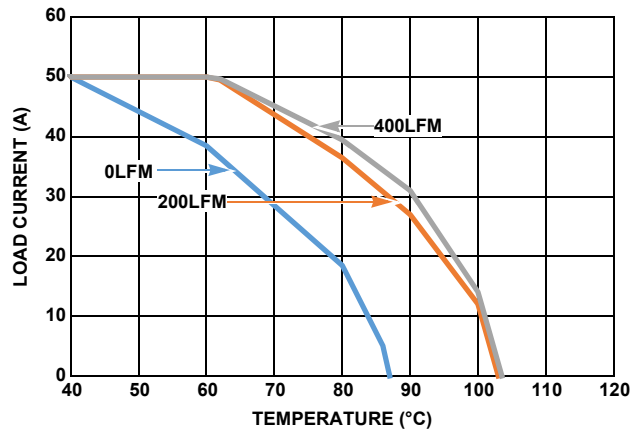

FIGURE 25. 12V_{IN} TO 5V_{OUT}, f_{SW} = 533kHz

Functional Description

SMBus Communications

The ISL8272M provides a PMBus digital interface that enables the user to configure all aspects of the module operation as well as monitor the input and output parameters. The ISL8272M can be used with any SMBus host device. In addition, the module is compatible with PMBus Power System Management Protocol Specification Parts I and II version 1.2. The ISL8272M accepts most standard PMBus commands. When configuring the device with PMBus commands, it is recommended that the enable pin is tied to SGND.

The SMBus device address is the only parameter that must be set by external pins. All other device parameters can be set with PMBus commands.

The ISL8272M can operate without the PMBus in pin-strap mode with configurations programmed by pin-strap resistors, such as output voltage, switching frequency, device SMBus address, input UVLO, soft-start/stop, and current sharing. Note: pin-strap resistors with 1% tolerance or better should be used for all the pin-strap settings.

Output Voltage Selection

The output voltage may be set to a voltage between 0.6V and 5V if the input voltage is higher than the desired output voltage by an amount sufficient to maintain regulation.

The VSET pin is used to set the output voltage to levels as shown in [Table 3](#). The R_{SET} resistor is placed between the VSET pin and SGND. A standard 1% resistor is required.

TABLE 3. OUTPUT VOLTAGE RESISTOR SETTINGS

V _{OUT} (V)	R _{SET} (kΩ)
0.60	10
0.65	11
0.70	12.1
0.75	13.3
0.80	14.7
0.85	16.2
0.90	17.8
0.95	19.6
1.00	21.5, or connect to SGND
1.05	23.7
1.10	26.1
1.15	28.7
1.20	31.6, or OPEN
1.25	34.8
1.30	38.3
1.40	42.2
1.50	46.4
1.60	51.1

TABLE 3. OUTPUT VOLTAGE RESISTOR SETTINGS (Continued)

V _{OUT} (V)	R _{SET} (kΩ)
1.70	56.2
1.80	61.9
1.90	68.1
2.00	75
2.10	82.5
2.20	90.9
2.30	100
2.50	110, or connect to V25
2.80	121
3.00	133
3.30	147
4.00	162
5.00	178

The output voltage may also be set to any value between 0.6V and 5V using the PMBus command VOUT_COMMAND. This device supports dynamic voltage scaling by allowing change to the output voltage set point during regulation. The voltage transition rate is specified with the PMBus command VOUT_TRANSITION_RATE.

By default, V_{OUT_MAX} is set 110% higher than V_{OUT} set by the pin strap resistor, which can be changed to any value up to 5.5V with the PMBus command VOUT_MAX.

Soft-Start/Stop Delay and Ramp Times

The ISL8272M follows an internal start-up procedure after power is applied to the VDD pin. The module requires approximately 60ms to 70ms to check for specific values stored in its internal memory and programmed by pin-strap resistors. Once this process is completed, the device is ready to accept commands from the PMBus interface and the module is ready to be enabled. If the module is to be synchronized to an external clock source, the clock frequency must be stable prior to asserting the EN pin.

It may be necessary to set a delay from when an enable signal is received until the output voltage starts to ramp to its target value. In addition, the designer may wish to precisely set the time required for V_{OUT} to ramp to its target value after the delay period has expired. These features may be used as part of an overall in-rush current management strategy or to precisely control how fast a load IC is turned on. The ISL8272M gives the system designer several options for precisely and independently controlling both the delay and ramp time periods. The soft-start delay period begins when the EN pin is asserted and ends when the delay time expires.

The soft-start delay and ramp up time can be programmed to custom values with the PMBus commands TON_DELAY and TON_RISE. When the delay time is set to 0ms, the device begins its ramp-up after the internal circuitry has initialized (approximately 2ms). When the soft-start ramp period is set to 0ms, the output ramps up as quickly as the output load capacitance and loop settings allow. It is generally

recommended to set the soft-start ramp to a value greater than 1ms to prevent inadvertent fault conditions due to excessive in-rush current.

Similar to the soft-start delay and ramp up time, the delay and ramp down time for soft-stop/off can be programmed with the PMBus commands TOFF_DELAY and TOFF_FALL. In addition, the module can be configured as “immediate off” with the command ON_OFF_CONFIG, such that the FETs are turned off immediately after the delay time expires.

In Current Sharing mode where multiple ISL8272M modules are connected in parallel, ASCR must be disabled for the ramp up with the USER_CONFIG command. Therefore, the soft-start rise time is not equal to TON_RISE. It can be calculated approximately by [Equation 1](#).

$$(EQ. 1) \quad \text{Rise Time (ms)} \approx \frac{\text{TON_RISE}}{V_{\text{IN}} \times f_{\text{SW}}} \times 330\text{kHz} \times 12\text{V}$$

In Current Sharing mode, ASCR will be enabled automatically upon power good assertion after the ramp completes. To avoid premature ASCR turn on, it is recommended to increase POWER_GOOD_DELAY if the rise time exceeds 10ms. In addition, only “immediate off” is supported for current sharing.

The SS/UVLO pin can be used to program the soft start/stop delay time and ramp time to some typical values as shown in [Table 4](#). A standard 1% resistor is required.

TABLE 4. SOFT START/STOP RESISTOR SETTINGS

DELAY TIME (ms)	RAMP TIME (ms)	R _{SET} (kΩ)
5	2	19.6, or connect to SGND
10	2	21.5
5	5	23.7, or OPEN
10	5	26.1
20	5	28.7
5	10	31.6
10	10	34.8, or connect to V25
20	10	38.3
5	2	42.2
10	2	46.4
5	5	51.1
10	5	56.2
20	5	61.9
5	10	68.1
10	10	75
20	10	82.5

Power-Good

The ISL8272M provides a Power-Good (PG) signal that indicates the output voltage is within a specified tolerance of its target level and no fault condition exists. By default, the PG pin asserts if the output is within 10% of the target voltage. This limit may be changed using the PMBus command POWER_GOOD_ON.

A PG delay period is defined as the time from when all conditions within the ISL8272M for asserting PG are met to when the PG pin is actually asserted. This feature is commonly used instead of using an external reset controller to control external digital logic. A PG delay can be programmed with the PMBus command POWER_GOOD_DELAY.

Switching Frequency and PLL

The device's switching frequency is set from 296kHz to 1067kHz using the pin strap method (for standalone non-current sharing module only) as shown in [Table 5](#), or by using the PMBus command FREQUENCY_SWITCH. The ISL8272M incorporates an internal phase-locked loop (PLL) to clock the internal circuitry. The PLL can be driven by an external clock source connected to the SYNC pin. The incoming clock signal must be in the range of 300kHz to 1.33MHz and must be stable when the enable pin is asserted. When using an external clock, the frequencies are not limited to discrete values as when using the internal clock. The external clock signal must not vary more than 10% from its initial value and should have a minimum pulse width of 150ns. It is recommended that when using an external clock, the same frequency should be set in the FREQUENCY_SWITCH command. In case the external clock is lost, the module will automatically switch to the internal clock. When using the internal oscillator, the SYNC pin can be configured as a clock source as an external sync to other modules. Refer to the SYNC_CONFIG command on [page 48](#) for more information. Note: if the pin-strap method is used, a standard 1% resistor is required.

TABLE 5. SWITCHING FREQUENCY RESISTOR SETTINGS

f _{SW} (kHz)	R _{SET} (kΩ)
296	14.7, or connect to SGND
320	16.2
364	17.8
400	19.6
421	21.5, or OPEN
471	23.7
533	26.1
571	28.7
615	31.6, or connect to V25
727	34.8
800	38.3
842	42.2
889	46.4
1067	51.1

Loop Compensation

The module loop response is programmable using the PMBus command `ASCR_CONFIG` or by using the pin-strap method (ASCR pin) according to [Table 6](#). A standard 1% resistor is required. The ISL8272M uses the ChargeMode™ control algorithm that responds to output current changes within a single PWM switching cycle, achieving a smaller total output voltage variation with less output capacitance than traditional PWM controllers.

TABLE 6. ASCR RESISTOR SETTINGS

ASCR GAIN	ASCR RESIDUAL	R _{SET} (kΩ)
80	90	10
120	90	11, or connect to SGND
160	90	12.1
200	90	13.3, or OPEN
240	90	14.7
280	90	16.2
320	90	17.8
360	90	19.6
400	90	21.5
450	90	23.7
500	90	26.1
550	90	28.7
600	90	31.6
700	90	34.8
800	90	38.3
80	100	42.2
120	100	46.4
160	100	51.1
200	100	56.2
240	100	61.9
280	100	68.1
320	100	75
360	100	82.5
400	100	90.9
450	100	100
500	100	110, or connect to V25
550	100	121
600	100	133
700	100	147
800	100	162

Input Undervoltage Lockout (UVLO)

The input undervoltage lockout (UVLO) prevents the ISL8272M from operating when the input falls below a preset threshold, indicating the input supply is out of its specified range. The UVLO threshold (V_{UVLO}) can be set between 4.18V and 16V by using a PMBus command `VIN_UV_FAULT_LIMIT`. Using the pin strap method (SS/UVLO pin) as shown in [Table 7](#), allows to set the V_{UVLO} to two typical values. A standard 1% resistor is required.

Fault response to an input undervoltage fault can be programmed with PMBus command `VIN_UV_FAULT_RESPONSE`. If the input undervoltage fault retry is enabled, the module will shut down immediately once the input voltage falls below V_{UVLO} and then check the input voltage every 70ms. If the input voltage rises above the input undervoltage warning level, the module will restart. The input undervoltage warning is $1.05 \cdot V_{UVLO}$ by default and can be programmed with the PMBus command `VIN_UV_WARN_LIMIT`. Note that fault retry is not supported in the current sharing configuration.

TABLE 7. UVLO RESISTOR SETTINGS

UVLO (V)	R _{SET} (kΩ)
4.5	OPEN
4.5	Connect to V25
4.5	Connect to SGND
4.5	19.6, 21.5, 23.7, 26.1, 28.7, 31.6, 34.8, 38.3
10.8	42.2, 46.4, 51.1, 56.2, 61.9, 68.1, 75, 82.5,

SMBus Module Address Selection

Each module must have its own unique serial address to distinguish between other devices on the bus. The module address is set by connecting a resistor between the SA pin and SGND. [Table 8](#) lists the available module addresses. A standard 1% resistor is required.

TABLE 8. SMBus ADDRESS RESISTOR SELECTION

R _{SA} (kΩ)	SMBus ADDRESS
10	19h
11	1Ah
12.1	1Bh
13.3	1Ch
14.7	1Dh
16.2	1Eh
17.8	1Fh
19.6	20h
21.5	21h
23.7	22h
26.1	23h
28.7	24h
31.6	25h
34.8, or connect to SGND	26h
38.3	27h
42.2, or Open	28h
46.4	29h
51.1	2Ah
56.2	2Bh
61.9	2Ch
68.1	2Dh
75	2Eh

TABLE 8. SMBus ADDRESS RESISTOR SELECTION (Continued)

R_{SA} (k Ω)	SMBus ADDRESS
82.5	2Fh
90.9	30h
100	31h
110	32h
121	33h
133	34h
147	35h
162	36h
178	37h

Output Overvoltage Protection

The ISL8272M offers an internal output overvoltage protection circuit that can protect sensitive load circuitry from being subjected to a voltage higher than its prescribed limits. A hardware comparator compares the actual output voltage (seen at the VSENp and VSENn pins) to a threshold set to 15% higher than the target output voltage (the default setting). The fault threshold can be programmed to a desired level with the PMBus command VOUT_OV_FAULT_LIMIT. If the VSENp voltage exceeds this threshold, the module will initiate an immediate shutdown without retry. A 70ms continuous retry can be enabled with the PMBus command VOUT_OV_FAULT_RESPONSE. Note that fault retry is not supported in the current sharing configuration.

Internal to the module, two 22 Ω resistors are populated from V_{OUT} to VSENp and SGND to VSENn to protect from overvoltage conditions in case of open at voltage sensing pins and differential remote sense traces due to assembly error. As long as differential remote sense traces have low resistance, V_{OUT} regulation accuracy is not sacrificed.

Output Prebias Protection

An output prebias condition exists when an externally applied voltage is present on a power supply's output before the power supply's control IC is enabled. Certain applications require that the converter not be allowed to sink current during start-up if a prebias condition exists at the output. The ISL8272M provides prebias protection by sampling the output voltage prior to initiating an output ramp.

If a prebias voltage lower than the target voltage exists after the pre-configured delay period has expired, the target voltage is set to match the existing prebias voltage and both drivers are enabled. The output voltage is then ramped to the final regulation value at the pre-configured ramp rate.

The actual time the output takes to ramp from the prebias voltage to the target voltage varies, depending on the prebias voltage; however, the total time elapsed from when the delay period expires to when the output reaches its target value will match the pre-configured ramp time (see [Figure 26](#)).

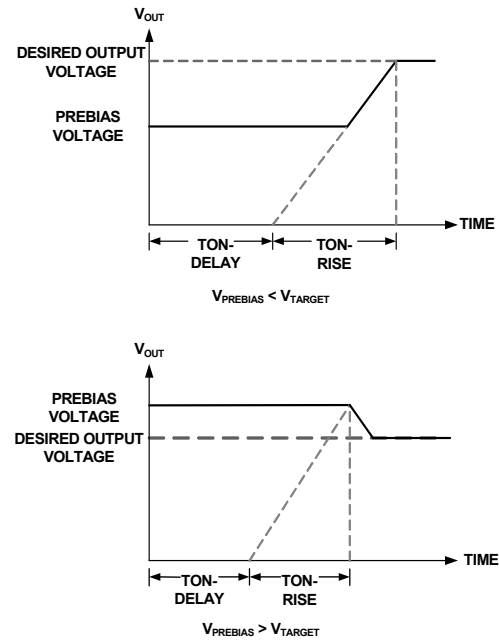

FIGURE 26. OUTPUT RESPONSES TO PREBIAS VOLTAGES

If a prebias voltage is higher than the target voltage after the pre-configured delay period has expired, the target voltage is set to match the existing prebias voltage and both drivers are enabled with a PWM duty cycle that would ideally create the prebias voltage.

Once the preconfigured soft-start ramp period has expired, the PG pin is asserted (assuming the prebias voltage is not higher than the overvoltage limit). The PWM then adjusts its duty cycle to match the original target voltage and the output ramps down to the pre-configured output voltage.

If a prebias voltage is higher than the overvoltage limit, the device does not initiate a turn-on sequence and declares an overvoltage fault condition. The device then responds based on the output overvoltage fault response setting programmed with the PMBus command VOUT_OV_FAULT_RESPONSE.

Output Overcurrent Protection

The ISL8272M can protect the power supply from damage if the output is shorted to ground or if an overload condition is imposed on the output. Average output overcurrent fault threshold can be programmed with the PMBus command IOUT_OC_FAULT_LIMIT. The module automatically programs the peak inductor current fault threshold by calculating the inductor ripple current from the input voltage, switching frequency, and the VOUT_COMMAND. When the peak inductor current crosses the peak inductor current fault threshold for three successive switching cycles it will initiate an immediate shutdown.

The default response from an overcurrent fault is an immediate shutdown without retry. A 70ms continuous retry can be enabled with the PMBus command MFR_IOUT_OC_FAULT_RESPONSE. It is required to enable the output undervoltage fault retry with the PMBus command VOUT_UV_FAULT_RESPONSE command simultaneously if the overcurrent fault retry is enabled. Note that fault retry is not supported in the current sharing configuration.

Thermal Overload Protection

The ISL8272M includes a thermal sensor that continuously measures the internal temperature of the module and shuts down the controller when the temperature exceeds the preset limit. The default temperature limit is set to +125°C in the factory, but can be changed with PMBus command OT_FAULT_LIMIT.

The default response from an over-temperature fault is an immediate shutdown without retry. Retry settings can be programmed with the PMBus command OT_FAULT_RESPONSE. Hysteresis is implemented with the over-temperature fault retry. If retry is enabled, the module will shut down immediately upon an over-temperature fault event and then check the temperature every 70ms. If the temperature falls below the over-temperature warning level, the module will restart. The over-temperature warning is +105° by default and programmable with the PMBus command OT_WARN_LIMIT. Note that fault retry is not supported in the current sharing configuration.

Digital-DC Bus

The Digital-DC Communications (DDC) bus is used to communicate between Intersil digital power modules and digital controllers. This dedicated bus provides the communication channel between devices for features such as current sharing, sequencing, and fault spreading. The DDC pin on all Digital-DC devices in an application should be connected together. A pull-up resistor is required on the DDC bus in order to guarantee the rise time as shown in Equation 2:

$$(EQ. 2) \quad \text{Rise Time} = R_{PU} * C_{LOAD} < 1 \mu s$$

where R_{PU} is the DDC bus pull-up resistance and C_{LOAD} is the bus loading. The pull-up resistor may be tied to an external 3.3V or 5V supply as long as this voltage is present prior to or during device power-up. In principle, each device connected to the DDC bus presents approximately 10pF of capacitive loading and each inch of FR4 PCB trace introduces approximately 2pF. The ideal design uses a central pull-up resistor that is well-matched to the total load capacitance.

Active Current Sharing

Paralleling multiple ISL8272M modules can increase the output current capability of a single power rail. By connecting the DDC and SYNC pins of each module together and configuring the modules as a current sharing rail, the units will share the current equally within a few percent.

Figure 27 illustrates a typical connection for two modules.

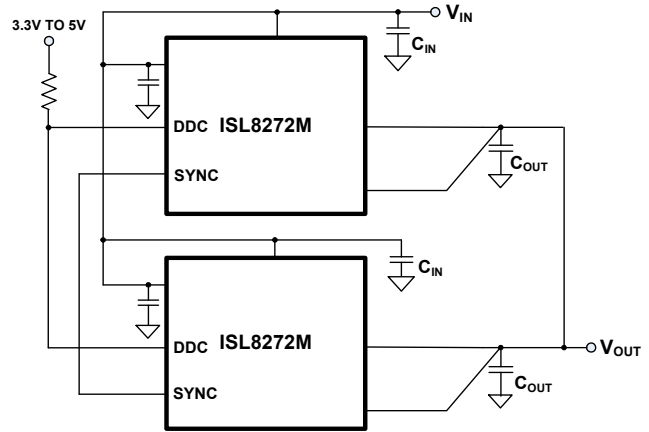

FIGURE 27. CURRENT SHARING GROUP

The ISL8272M uses a DDC bus based digital current sharing technique to balance the steady state module output current by aligning the load lines of member modules to a reference module.

When multiple ISL8272M modules are connected for current sharing, a non-zero active droop resistance must be set to add artificial resistance in the output voltage path to control the slope of the load line curve, calibrating out the physical parasitic mismatches due to power train components and PCB layout. The active droop resistance can be programmed with the PMBus command VOUT_DROOP based on Equation 3. Typically, higher droop value offers a more accurate dynamic current sharing at the sacrifice of output load regulation. 1% droop at full load will be a good trade-off between output load regulation and dynamic current sharing.

$$(EQ. 3) \quad \frac{V_{OUT}}{I_{LOAD(MAX)}} \times 0.005 \leq \text{Droop} \leq \frac{V_{OUT}}{I_{LOAD(MAX)}} \times 0.015$$

Upon system start-up, the module with the lowest device position as selected in DDC_CONFIG is defined as the reference module. The remaining modules are members. The reference module broadcasts its current over the DDC bus. The members use the reference current information to trim their voltages (V_{MEMBER}) to balance the current loading of each module in the system.

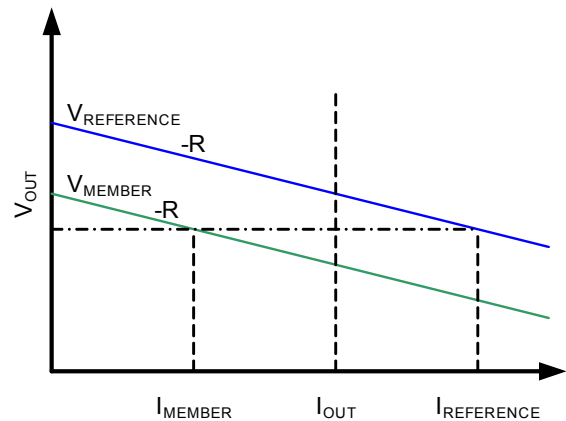

FIGURE 28. ACTIVE CURRENT SHARING

Figure 28 on page 21 shows that, for load lines with identical slopes, the member voltage is increased towards the reference voltage which closes the gap between the inductor currents.

The relation between reference and member current and voltage is given by Equation 4:

$$(EQ. 4) \quad V_{MEMBER} = V_{OUT} + R \times (I_{REFERENCE} - I_{MEMBER})$$

where R is the value of the droop resistance.

The DDC_CONFIG command configures the module for active current sharing. The default setting is a standalone non current sharing module.

For fault configuration, it is required to enable the fault spreading mode in the current sharing rail with the PMBus command DDC_GROUP. Broadcast operation must be enabled with the DDC_GROUP command to allow start up/shut down and margining operations. It is optional to enable V_{OUT} broadcast in the DDC_GROUP command to allow V_{OUT} set point change dynamically during operation.

In the multiple-module current sharing configuration, it is required to synchronize all modules to the same switching clock by tying the SYNC pins together. The clock source can be selected either from one module or from an external clock with the SYNC_CONFIG command. The phase offset of current sharing modules is automatically set according to the device positions and number of devices specified in the DDC_CONFIG command.

The pin strap method is offered for the current sharing configuration with the CS pin. Table 9 lists the current sharing pin strap settings. A standard 1% resistor is required. Note that fault retry is not supported in the current sharing configuration.

TABLE 9. CURRENT SHARING RESISTOR SETTINGS

CLOCK CONFIGURATION	DEVICE POSITION - NUMBER OF DEVICES	DROOP (mV/A)	R _{SET} (kΩ)
Output internal	1-2	0.1	10
External	2-2	0.1	11
Output internal	1-2	0.15	12.1
External	2-2	0.15	13.3
Output internal	1-2	0.2	14.7
External	2-2	0.2	16.2
Output internal	1-2	0.25	17.8
External	2-2	0.25	19.6
Output internal	1-2	0.3	21.5
External	2-2	0.3	23.7
Output internal	1-3	0.07	26.1
External	2-3	0.07	28.7
External	3-3	0.07	31.6
Output internal	1-3	0.1	34.8
External	2-3	0.1	38.3
External	3-3	0.1	42.2

TABLE 9. CURRENT SHARING RESISTOR SETTINGS (Continued)

CLOCK CONFIGURATION	DEVICE POSITION - NUMBER OF DEVICES	DROOP (mV/A)	R _{SET} (kΩ)
Output internal	1-3	0.13	46.4
External	2-3	0.13	51.1
External	3-3	0.13	56.2
Output internal	1-3	0.16	61.9
External	2-3	0.16	68.1
External	3-3	0.16	75
Output internal	1-3	0.2	82.5
External	2-3	0.2	90.9
External	3-3	0.2	100
Output internal	1-4	0.14	110 (available with FC02 firmware only)
External	2-4	0.14	121 (available with FC02 firmware only)
External	3-4	0.14	133 (available with FC02 firmware only)
External	4-4	0.14	147 (available with FC02 firmware only)
Internal only	1-1	0	Connect to SGND (for immediate off)
Internal only	1-1	0	OPEN (for soft off)

Phase Spreading

When multiple point-of-load converters share a common DC input supply, it is desirable to adjust the clock phase offset of each device so that not all devices start to switch simultaneously. Setting each converter to start its switching cycle at a different point in time can dramatically reduce input capacitance requirements and efficiency losses. Because the peak current drawn from the input supply is effectively spread out over a period of time, the peak current drawn at any given moment is reduced and the power losses proportional to the I_{RMS}^2 are reduced dramatically.

To enable phase spreading, all converters must be synchronized to the same switching clock. The phase offset of each device may also be set to any value between 0° and 360° in 22.5° increments with the PMBus command INTERLEAVE. The internal two phases of the module always maintain a phase difference of 180°.

Fault Spreading

Digital-DC modules and devices can be configured to broadcast a fault event over the DDC bus to the other devices in the group with the PMBus command DDC_GROUP. When a nondestructive fault occurs, the device shuts down and broadcasts the fault

event over the DDC bus. The other devices on the DDC bus shut down simultaneously if configured to do so, and attempt to restart.

Note that fault retry is not supported in multiple modules with fault spreading enabled, such as the current sharing configuration.

Output Sequencing

A group of Digital-DC modules or devices may be configured to power-up in a predetermined sequence. This feature is especially useful when powering advanced processors (FPGAs and ASICs) that require one supply to reach its operating voltage prior to another supply reaching its operating voltage in order to avoid latch-up. Multi-device sequencing can be achieved by configuring each device with the PMBus command SEQUENCE. Multiple device sequencing is configured by issuing PMBus commands to assign the preceding device in the sequencing chain as well as the device that follows in the sequencing.

The Enable pins of all devices in a sequencing group must be tied together and driven high to initiate a sequenced turn-on of the group. Enable must be driven low to initiate a sequenced turnoff of the group. It is recommended to enable fault spreading with the PMBus command DDC_GROUP within a sequencing group.

Monitoring with SMBus

A system controller can monitor a wide variety of different ISL8272M system parameters with PMBus commands:

- READ_VIN
- READ_VOUT
- READ_IOUT
- READ_INTERNAL_TEMP
- READ_DUTY_CYCLE
- READ_FREQUENCY
- READ_VMON

Snapshot Parameter Capture

The ISL8272M offers a special feature to capture parametric data and some fault status following a fault. A detailed description is provided in [“PMBus Commands Description” on page 29](#) under the PMBus commands SNAPSHOT and SNAPSHOT_CONTROL.

Nonvolatile Memory

The ISL8272M has internal nonvolatile memory where user configurations are stored. Integrated security measures ensure that the user can only restore the module to a level that has been made available to them. During the initialization process, the ISL8272M checks for stored values contained in its internal nonvolatile memory.

Modules are shipped with a factory default configuration and most settings can be overwritten with PMBus commands and can be stored in nonvolatile memory with the PMBus command STORE_USER_ALL.

Layout Guide

To achieve stable operation, low losses, and good thermal performance, proper layout ([Figure 29](#)) is important.

- Establish separate SGND plane and PGND planes, then connect SGND to the PGND plane on the middle layer and underneath PAD6 with a single point connection. For SGND and PGND pin connections, such as small pins H16, J16, M5, and M17..., use multiple vias for each pin to connect to the inner SGND or PGND layer.
- Place enough ceramic capacitors between VIN and PGND, VOUT and PGND and bypass capacitors between VDD, VDRV and the ground plane, as close to the module as possible to minimize high frequency noise. It is critical to place the output ceramic capacitors as close to the center of the two VOUT pads as possible, to create a low impedance path for the high frequency inductor ripple current.
- Use large copper areas for power path (VIN, PGND, VOUT) to minimize conduction loss and thermal stress. Also, use multiple vias to connect the power planes in different layers. It is recommended to enlarge PAD11 and PAD15 and to put more vias on these pads. The ceramic caps CIN can be put on the bottom layer under these two pads.
- Connect remote sensed traces to the regulation points to achieve a tight output voltage regulation and keep them in parallel. Route a trace from VSENN and VSENP to the point of load where the tight output voltage is desired. Avoid routing any sensitive signal traces, such as the VSENN, VSENP sensing point near the SW pins.
- The SW1 and SW2 pads are noisy pads, but they are beneficial for thermal dissipations. If the noise issue is critical for the applications, it is recommended to use top layer only for SW pads. For better thermal performance, use multiple vias on these pads to connect into SW inner and bottom layer. However, be very careful when placing limited SW planes in any layer. The SW planes should avoid the sensing signals and should be surrounded by the PGND layer to avoid noise coupling.
- For pins SWD1 (L3) and SWD2 (P10), it is recommended to connect to the related SW1 and SW2 pads with short loop wires. The wire width should be greater than 20 mils.

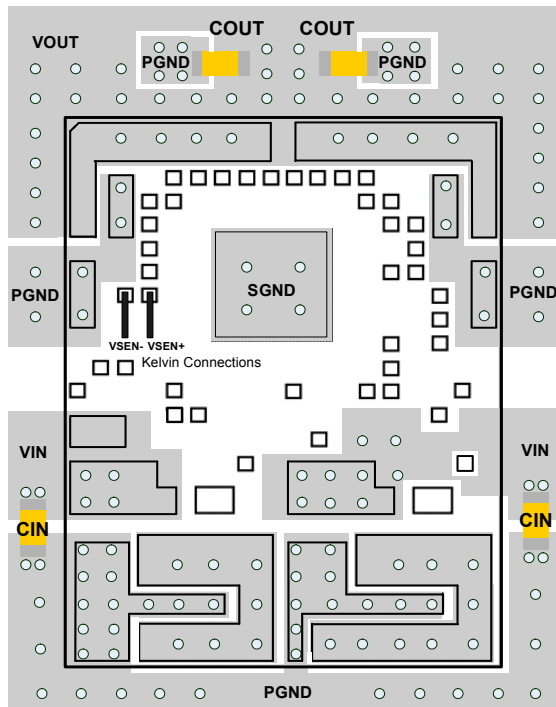

FIGURE 29. RECOMMENDED LAYOUT

Thermal Considerations

Experimental power loss curves along with θ_{JA} from thermal modeling analysis can be used to evaluate the thermal consideration for the module. The derating curves are derived from the maximum power allowed while maintaining the temperature below the maximum junction temperature of +125°C. In actual applications, other heat sources and design margins should be considered.

Package Description

The structure of the ISL8272M belongs to the High Density Array No-lead package (HDA). This package offers good thermal and electrical conductivity, low weight, and small size. The HDA package is applicable for surface mounting technology and is being more readily used in the industry. The ISL8272M contains several types of devices, including resistors, capacitors, inductors, and control ICs. The ISL8272M is a copper lead-frame based package with exposed copper thermal pads, which have good electrical and thermal conductivity. The copper lead frame and multi component assembly is overmolded with polymer mold compound to protect these devices.

The package outline and typical PCB layout pattern design and typical stencil pattern design are shown in the [“Package Outline Drawing”](#) starting on [page 53](#). The module has a small size of 18mmx23mmx7.5mm.

PCB Layout Pattern Design

The bottom of the ISL8272M is a lead-frame footprint, which is attached to the PCB by a surface mounting process. The PCB layout pattern is shown on [pages 57 to 59](#). The PCB layout pattern is an array of solder mask defined PCB lands which align with the perimeters of the HDA exposed pads and I/O termination dimensions. The thermal lands on the PCB layout

also feature an array of solder mask defined lands and should match 1:1 with the package exposed die pad perimeters. The exposed solder mask defined PCB land area should be 50-80% of the available module I/O area.

Thermal Vias

A grid of 1.0mm to 1.2mm pitch thermal vias, which drops down and connects to buried copper plane(s), should be placed under the thermal land. The vias should be about 0.3mm to 0.33mm in diameter with the barrel plated to about 1.0 ounce copper. Although adding more vias (by decreasing via pitch) will improve the thermal performance, diminishing returns will be seen as more and more vias are added. Simply use as many vias as practical for the thermal land size and your board design rules allow.

Stencil Pattern Design

Reflowed solder joints on the perimeter I/O lands should have about a 50µm to 75µm (2mil to 3mil) standoff height. The solder paste stencil design is the first step in developing optimized, reliable solder joints. The stencil aperture size to solder mask defined PCB land size ratio should typically be 1:1. The aperture width may be reduced slightly to help prevent solder bridging between adjacent I/O lands. A typical solder stencil pattern is shown in the [“Package Outline Drawing”](#) starting on [page 55](#). The gap width between pad to pad is 0.6mm. Consider the symmetry of the whole stencil pattern when designing its pads. A laser cut, stainless steel stencil with electropolished trapezoidal walls is recommended. Electropolishing “smooths” the aperture walls, resulting in reduced surface friction and better paste release which reduces voids. Using a Trapezoidal Section Aperture (TSA) also promotes paste release and forms a brick-like paste deposit that assists in firm component placement. A 0.1mm to 0.15mm stencil thickness is recommended for this large pitch HDA.

Reflow Parameters

Due to the HDA's low mount height, “No Clean” Type 3 solder paste per ANSI/J-STD-005 is recommended. Nitrogen purge is recommended during reflow. A system board reflow profile depends on the thermal mass of the entire populated board, so it is not practical to define a specific soldering profile just for the HDA. The profile in [Figure 30](#) is a guideline to be customized for varying manufacturing practices and applications.

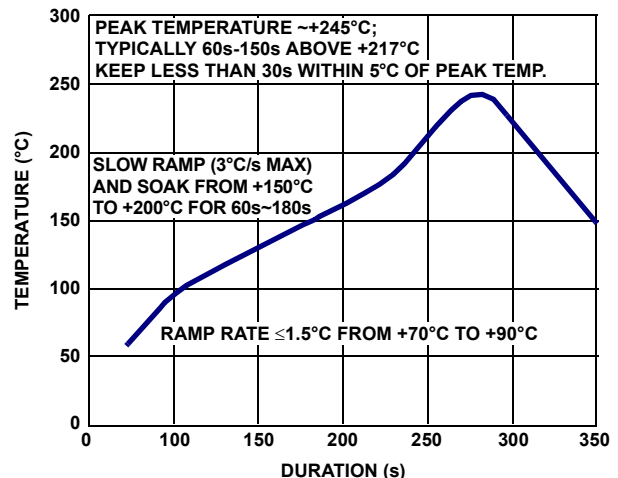

FIGURE 30. TYPICAL REFLOW PROFILE

PMBus Command Summary

COMMAND CODE	COMMAND NAME	DESCRIPTION	TYPE	DATA FORMAT	DEFAULT VALUE	DEFAULT SETTING	PAGE
01h	OPERATION	Sets Enable, Disable and V_{OUT} Margin modes.	R/W BYTE	BIT			29
02h	ON_OFF_CONFIG	Configures the EN pin and PMBus commands to turn the unit ON/OFF	R/W BYTE	BIT	16h	Hardware Enable, Soft Off	29
03h	CLEAR_FAULTS	Clears fault indications.	SEND BYTE				30
15h	STORE_USER_ALL	Stores all PMBus values written since last restore at user level.	SEND BYTE				30
16h	RESTORE_USER_ALL	Restores PMBus settings that were stored using STORE_USER_ALL.	SEND BYTE				30
20h	VOUT_MODE	Preset to defined data format of V_{OUT} commands.	READ BYTE	BIT	13h	Linear Mode, Exponent = -13	30
21h	VOUT_COMMAND	Sets the nominal value of the output voltage.	R/W WORD	L16u		Pin Strap	30
23h	VOUT_CAL_OFFSET	Applies a fixed offset voltage to the VOUT_COMMAND.	R/W WORD	L16s	0000h	0V	31
24h	VOUT_MAX	Sets the maximum possible value of V_{OUT} . 110% of pin strap V_{OUT} .	R/W WORD	L16u		$1.1 * V_{OUT}$ Pin Strap	31
25h	VOUT_MARGIN_HIGH	Sets the value of the V_{OUT} during a margin high.	R/W WORD	L16u		$1.05 * V_{OUT}$ Pin Strap	31
26h	VOUT_MARGIN_LOW	Sets the value of the V_{OUT} during a margin low.	R/W WORD	L16u		$0.95 * V_{OUT}$ Pin Strap	31
27h	VOUT_TRANSITION_RATE	Sets the transition rate during margin or other change of V_{OUT} .	R/W WORD	L11	BA00h	1V/ms	31
28h	VOUT_DROOP	Sets the loadline (V/I Slope) resistance for the rail.	R/W WORD	L11		Pin Strap	32
33h	FREQUENCY_SWITCH	Sets the switching frequency.	R/W WORD	L11		Pin Strap	32
37h	INTERLEAVE	Configures a phase offset between devices sharing a SYNC clock.	R/W WORD	BIT	0000h		32
38h	IOUT_CAL_GAIN	Sense resistance for inductor DCR current sensing.	R/W WORD	L11	B370h	0.86m Ω	32
39h	IOUT_CAL_OFFSET	Sets the current-sense offset.	R/W WORD	L11	0000h	0A	32
40h	VOUT_OV_FAULT_LIMIT	Sets the V_{OUT} overvoltage fault threshold.	R/W WORD	L16u		$1.15 * V_{OUT}$ Pin Strap	33
41h	VOUT_OV_FAULT_RESPONSE	Configures the V_{OUT} overvoltage fault response.	R/W BYTE	BIT	80h	Disable and No Retry	33
42h	VOUT_OV_WARN_LIMIT	Sets the V_{OUT} overvoltage warn threshold.	R/W WORD	L16u		$1.10 * V_{OUT}$ Pin Strap	33
43h	VOUT_UV_WARN_LIMIT	Sets the V_{OUT} undervoltage warn threshold.	R/W WORD	L16u		$0.9 * V_{OUT}$ Pin Strap	33
44h	VOUT_UV_FAULT_LIMIT	Sets the V_{OUT} undervoltage fault threshold.	R/W WORD	L16u		$0.85 * V_{OUT}$ Pin Strap	33
45h	VOUT_UV_FAULT_RESPONSE	Configures the V_{OUT} undervoltage fault response.	R/W BYTE	BIT	80h	Disable and No Retry	34
46h	IOUT_OC_FAULT_LIMIT	Sets the I_{OUT} average overcurrent fault threshold.	R/W WORD	L11	E3C0h	60A	34
4Bh	IOUT_UC_FAULT_LIMIT	Sets the I_{OUT} average undercurrent fault threshold.	R/W WORD	L11	E440h	-60A	34
4Fh	OT_FAULT_LIMIT	Sets the over-temperature fault threshold.	R/W WORD	L11	EBE8h	+125 °C	34
50h	OT_FAULT_RESPONSE	Configures the over-temperature fault response.	R/W BYTE	BIT	80h	Disable and No Retry	35

PMBus Command Summary (Continued)

COMMAND CODE	COMMAND NAME	DESCRIPTION	TYPE	DATA FORMAT	DEFAULT VALUE	DEFAULT SETTING	PAGE
51h	OT_WARN_LIMIT	Sets the over-temperature warning limit.	R/W WORD	L11	EB48h	+105 °C	35
52h	UT_WARN_LIMIT	Sets the under-temperature warning limit.	R/W WORD	L11	DC40h	-30 °C	35
53h	UT_FAULT_LIMIT	Sets the under-temperature fault threshold.	R/W WORD	L11	E580h	-40 °C	35
54h	UT_FAULT_RESPONSE	Configures the under-temperature fault response.	R/W BYTE	BIT	80h	Disable and No Retry	36
55h	VIN_OV_FAULT_LIMIT	Sets the V_{IN} overvoltage fault threshold.	R/W WORD	L11	D380h	14V	36
56h	VIN_OV_FAULT_RESPONSE	Configures the V_{IN} overvoltage fault response.	R/W BYTE	BIT	80h	Disable and No Retry	36
57h	VIN_OV_WARN_LIMIT	Sets the input overvoltage warning limit.	R/W WORD	L11	D353h	13.3V	36
58h	VIN_UV_WARN_LIMIT	Sets the input undervoltage warning limit.	R/W WORD	L11		$1.05 \cdot V_{IN}$ UV Fault Limit	37
59h	VIN_UV_FAULT_LIMIT	Sets the V_{IN} undervoltage fault threshold.	R/W WORD	L11		Pin Strap	37
5Ah	VIN_UV_FAULT_RESPONSE	Configures the V_{IN} undervoltage fault response.	R/W BYTE	BIT	80h	Disable and No Retry	37
5Eh	POWER_GOOD_ON	Sets the voltage threshold for Power-Good indication.	R/W WORD	L16u		$0.9 \cdot V_{OUT}$ Pin Strap	37
60h	TON_DELAY	Sets the delay time from ENABLE to start of V_{OUT} rise.	R/W WORD	L11		Pin Strap	37
61h	TON_RISE	Sets the rise time of V_{OUT} after ENABLE and TON_DELAY.	R/W WORD	L11		Pin Strap	38
64h	TOFF_DELAY	Sets the delay time from DISABLE to start of V_{OUT} fall.	R/W WORD	L11		Pin Strap	38
65h	TOFF_FALL	Sets the fall time for V_{OUT} after DISABLE and TOFF_DELAY.	R/W WORD	L11		Pin Strap	38
78h	STATUS_BYTE	Returns an abbreviated status for fast reads.	READ BYTE	BIT	00h	No Faults	38
79h	STATUS_WORD	Returns information with a summary of the units's fault condition.	READ WORD	BIT	0000h	No Faults	39
7Ah	STATUS_VOUT	Returns the V_{OUT} specific status.	READ BYTE	BIT	00h	No Faults	39
7Bh	STATUS_IOUT	Returns the I_{OUT} specific status.	READ BYTE	BIT	00h	No Faults	40
7Ch	STATUS_INPUT	Returns specific status specific to the input.	READ BYTE	BIT	00h	No Faults	40
7Dh	STATUS_TEMPERATURE	Returns the temperature specific status.	READ BYTE	BIT	00h	No Faults	40
7Eh	STATUS_CML	Returns the Communication, Logic and Memory specific status.	READ BYTE	BIT	00h	No Faults	41
80h	STATUS_MFR_SPECIFIC	Returns the VMON and External Sync clock specific status.	READ BYTE	BIT	00h	No Faults	41
88h	READ_VIN	Returns the input voltage reading.	READ WORD	L11			41
8Bh	READ_VOUT	Returns the output voltage reading.	READ WORD	L16u			41
8Ch	READ_IOUT	Returns the output current reading.	READ WORD	L11			42
8Dh	READ_INTERNAL_TEMP	Returns the temperature reading internal to the device.	READ WORD	L11			42

PMBus Command Summary (Continued)

COMMAND CODE	COMMAND NAME	DESCRIPTION	TYPE	DATA FORMAT	DEFAULT VALUE	DEFAULT SETTING	PAGE
94h	READ_DUTY_CYCLE	Returns the duty cycle reading during the ENABLE state.	READ WORD	L11			42
95h	READ_FREQUENCY	Returns the measured operating switch frequency.	READ WORD	L11			42
96h	READ_IOUT_0	Returns phase 1 current reading.	READ WORD	L11			42
97h	READ_IOUT_1	Returns phase 2 current reading.	READ WORD	L11			42
99h	MFR_ID	Sets a user defined identification.	R/W BLOCK	ASC		Null	43
9Ah	MFR_MODEL	Sets a user defined model.	R/W BLOCK	ASC		Null	43
9Bh	MFR_REVISION	Sets a user defined revision.	R/W BLOCK	ASC		Null	43
9Ch	MFR_LOCATION	Sets a user defined location identifier.	R/W BLOCK	ASC		Null	43
9Dh	MFR_DATE	Sets a user defined date.	R/W BLOCK	ASC		Null	43
9Eh	MFR_SERIAL	Sets a user defined serialized identifier.	R/W BLOCK	ASC		Null	44
A8H	LEGACY_FAULT_GROUP	Sets rail IDs of legacy devices for fault spreading	R/W BLOCK	BIT	00000000h	No rail ID specified	44
B0h	USER_DATA_00	Sets a user defined data.	R/W BLOCK	ASC		Null	44
D0h	ISENSE_CONFIG	Configures ISENSE related features.	R/W BYTE	BIT	05h	256ns Blanking Time, Mid Range	44
D1h	USER_CONFIG	Configures several user-level features.	R/W BYTE	BIT		Pin Strap (ASCR on/off for start up)	45
D3h	DDC_CONFIG	Configures the DDC bus.	R/W WORD	BIT		Pin Strap (set based on PMBus address and CS)	45
D4h	POWER_GOOD_DELAY	Sets the delay between $V_{OUT} > PG$ threshold and asserting the PG pin.	R/W WORD	L11	C300h	3ms	46
DFh	ASCR_CONFIG	Configures ASCR control loop.	R/W BLOCK	CUS		Pin Strap	46
E0h	SEQUENCE	Identifies the Rail DDC ID to perform multi-rail sequencing.	R/W WORD	BIT	0000h	Prequel and Sequel Disabled	46
E2h	DDC_GROUP	Sets rail DDC IDs to obey faults and margining spreading information.	R/W BLOCK	BIT		Pin Strap (set based on CS)	47
E4h	DEVICE_ID	Returns the 16-byte (character) device identifier string.	READ BLOCK	ASC		Reads Device Version	47
E5h	MFR_IOUT_OC_FAULT_RESPONSE	Configures the I_{OUT} overcurrent fault response.	R/W BYTE	BIT	80h	Disable and No Retry	47
E6h	MFR_IOUT_UC_FAULT_RESPONSE	Configures the I_{OUT} undercurrent fault response.	R/W BYTE	BIT	80h	Disable and No Retry	48
E9h	SYNC_CONFIG	Configures the Sync pin.	R/W BYTE	BIT		Pin Strap (set based on CS)	48
EAh	SNAPSHOT	Returns 32-byte read-back of parametric and status values.	READ BLOCK	BIT			49
EBh	BLANK_PARAMS	Returns recently changed parameter values.	READ BLOCK	BIT	FF...FFh		49
F3h	SNAPSHOT_CONTROL	Snapshot feature control command.	R/W BYTE	BIT			49
F4h	RESTORE_FACTORY	Restores device to the factory default values.	SEND BYTE				50
F5h	MFR_VMON_OV_FAULT_LIMIT	Returns the VMON overvoltage threshold.	READ WORD	L11	CB00h	6V	50

PMBus Command Summary (Continued)

COMMAND CODE	COMMAND NAME	DESCRIPTION	TYPE	DATA FORMAT	DEFAULT VALUE	DEFAULT SETTING	PAGE
F6h	MFR_VMON_UV_FAULT_LIMIT	Returns the VMON undervoltage threshold.	READ WORD	L11	CA00h	4V	50
F7h	MFR_READ_VMON	Returns the VMON voltage reading.	READ WORD	L11			50
F8h	VMON_OV_FAULT_RESPONSE	Returns the VMON overvoltage response.	READ BYTE	BIT	80h	Disable and No Retry	50
F9h	VMON_UV_FAULT_RESPONSE	Returns the VMON undervoltage response.	READ BYTE	BIT	80h	Disable and No Retry	50

PMBus Data Formats

Linear-11 (L11)

The L11 data format uses 5-bit two's complement exponent (N) and 11-bit two's complement mantissa (Y) to represent real world decimal value (X).

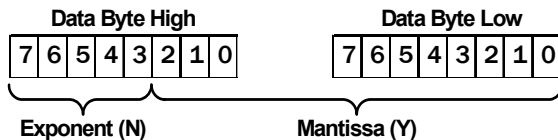

The relation between real world decimal value (X), N and Y is: $X = Y \cdot 2^N$

Linear-16 Unsigned (L16u)

L16u data format uses a fixed exponent (hard-coded to $N = -13h$) and a 16-bit unsigned integer mantissa (Y) to represent real world decimal value (X). Relation between real world decimal value (X), N and Y is: $X = Y \cdot 2^{-13}$

Linear-16 Signed (L16s)

The L16s data format uses a fixed exponent (hard-coded to $N = -13h$) and a 16-bit two's complement mantissa (Y) to represent real world decimal value (X).

Relation between real world decimal value (X), N and Y is: $X = Y \cdot 2^{-13}$

Bit Field (BIT)

An explanation of Bit Field is provided in [“PMBus Commands Description” on page 29](#).

Custom (CUS)

An explanation of Custom data format is provided in [“PMBus Commands Description” on page 29](#). A combination of Bit Field and integer are common type of Custom data format.

ASCII (ASC)

A variable length string of text characters that uses the ASCII data format.

PMBus Use Guidelines

The PMBus is a powerful tool that allows the user to optimize circuit performance by configuring devices for their application. When configuring a device in a circuit, the device should be disabled whenever most settings are changed with PMBus commands. Some exceptions to this recommendation are OPERATION, ON_OFF_CONFIG, CLEAR_FAULTS, VOUT_COMMAND, VOUT_MARGIN_HIGH, VOUT_MARGIN_LOW, and ASCCR_CONFIG. While the device is enabled any command can be read. Many commands do not take effect until after the device has been re-enabled, hence the recommendation that commands that change device settings are written while the device is disabled.

When sending the STORE_DEFAULT_ALL, STORE_USER_ALL, RESTORE_DEFAULT_ALL, and RESTORE_USER_ALL commands, it is recommended that no other commands are sent to the device for 100ms after sending STORE or RESTORE commands.

In addition, there should be a 2ms delay between repeated READ commands sent to the same device. When sending any other command, a 5ms delay is recommended between repeated commands sent to the same device. Commands not listed in the PMBus command summary are not allowed for customer use, and are reserved for factory use only. Issuing reserved commands may result in unexpected operation.

Summary

All commands can be read at any time.

Always disable the device when writing commands that change device settings. Exceptions to this rule are commands intended to be written while the device is enabled, for example, VOUT_MARGIN_HIGH.

To be sure a change to a device setting has taken effect, write the STORE_USER_ALL command, then cycle input power and re-enable.

PMBus Commands Description

OPERATION (01h)

Definition: Sets Enable, Disable, and V_{OUT} Margin settings. OPERATION data values that force the margin high or low only take effect when the MGN pin is left open (in the NOMINAL margin state).

Data Length in Bytes: 1

Data Format: BIT

Type: R/W

Default Value:

Units: N/A

SETTINGS	ACTIONS
04h	Immediate off (no sequencing)
44h	Soft off (with sequencing)
84h	On - Nominal
94h	On - Margin low
A4h	On - Margin high

ON_OFF_CONFIG (02h)

Definition: Configures the interpretation and coordination of the OPERATION command and the ENABLE pin (EN).

Data Length in Bytes: 1

Data Format: BIT

Type: R/W

Default Value: 16h (Device starts from ENABLE pin with soft off)

Units: N/A

SETTINGS	ACTIONS
16h	Device starts from ENABLE pin with soft off.
17h	Device starts from ENABLE pin with immediate off.
1Ah	Device starts from OPERATION command with soft off.
1Bh	Device starts from OPERATION command with immediate off.

CLEAR_FAULTS (03h)

Definition: Clears all fault bits in all registers and releases the SALRT pin (if asserted) simultaneously. If a fault condition still exists, the bit will reassert immediately. This command will not restart a device if it has shut down, it will only clear the faults.

Data Length in Bytes: 0 Byte

Data Format: N/A

Type: Write only

Default Value: N/A

Units: N/A

Reference: N/A

STORE_USER_ALL (15h)

Definition: Stores all PMBus settings from the operating memory to the nonvolatile USER store memory. To clear the USER store, perform a RESTORE_FACTORY then STORE_USER_ALL. To add to the USER store, perform a RESTORE_USER_ALL, write commands to be added, then STORE_USER_ALL. This command can be used during device operation, but the device will be unresponsive for 20ms while storing values.

Data Length in Bytes: 0

Data Format: N/A

Type: Write only

Default Value: N/A

Units: N/A

RESTORE_USER_ALL (16h)

Definition: Restores all PMBus settings from the USER store memory to the operating memory. Command performed at power-up. Security level is changed to Level 1 following this command. This command can be used during device operation, but the device will be unresponsive for 20ms while storing values.

Data Length in Bytes: 0

Data Format: N/A

Type: Write only

Default Value: N/A

Units: N/A

VOUT_MODE (20h)

Definition: Reports the V_{OUT} mode and provides the exponent used in calculating several V_{OUT} settings. Fixed with linear mode with default exponent (N) = -13

Data Length in Bytes: 1

Data Format: BIT

Type: Read-only

Default Value: 13h (Linear Mode, N = -13)

Units: N/A

VOUT_COMMAND (21h)

Definition: Sets or reports the target output voltage. This command cannot set a value higher than either V_{OUT_MAX} or 110% of the pin strap V_{OUT} setting.

Data Length in Bytes: 2

Data Format: L16u

Type: R/W

Default Value: Pin strap setting

Units: Volts

Range: 0V to V_{OUT_MAX}

VOUT_CAL_OFFSET (23h)

Definition: Applies a fixed offset voltage to the output voltage command value. This command is typically used by the user to calibrate a device in the application circuit.

Data Length in Bytes: 2

Data Format: L16s

Type: R/W

Default Value: 0000h

Units: Volts

VOUT_MAX (24h)

Definition: Sets an upper limit on the output voltage the unit can command regardless of any other commands or combinations. The intent of this command is to provide a safeguard against a user accidentally setting the output voltage to a possibly destructive level rather than to be the primary output overprotection. The default value can be changed using PMBus.

Data Length in Bytes: 2

Data Format: L16u

Type: R/W

Default Value: 1.10xVOUT_COMMAND pin strap setting

Units: Volts

Range: 0V to 5.5V

VOUT_MARGIN_HIGH (25h)

Definition: Sets the value of the V_{OUT} during a margin high. The VOUT_MARGIN_HIGH command loads the unit with the voltage to which the output is to be changed when the OPERATION command or MGN pin is set to "Margin High".

Data Length in Bytes: 2

Data Format: L16u

Type: R/W

Default value: 1.05 x VOUT_COMMAND pin strap setting

Units: V

Range: 0V to VOUT_MAX

VOUT_MARGIN_LOW (26h)

Definition: Sets the value of the V_{OUT} during a margin low. The VOUT_MARGIN_LOW command loads the unit with the voltage to which the output is to be changed when the OPERATION command or MGN pin is set to "Margin Low".

Data Length in Bytes: 2

Data Format: L16u

Type: R/W

Default value: 0.95 x VOUT_COMMAND pin strap setting

Units: V

Range: 0V to VOUT_MAX

VOUT_TRANSITION_RATE (27h)

Definition: Sets the rate at which the output should change voltage when the device receives the VOUT_COMMAND or an OPERATION command (Margin High, Margin Low) that causes the output voltage to change. The maximum possible positive value of the two data bytes indicates that the device should make the transition as quickly as possible.

Data Length in Bytes: 2

Data Format: L11

Type: R/W

Default value: BA00h (1.0 V/ms)

Units: V/ms

Range: 0.1 to 4V/ms

VOUT_DROOP (28h)

Definition: Sets the effective load line (V/I slope) for the rail in which the device is used. It is the rate, in mV/A, at which the output voltage decreases (or increases) with increasing (or decreasing) output current for use with Adaptive Voltage Positioning schemes or multi-module current sharing. In the current sharing configuration, VOUT_DROOP set in each module stands for the droop seen by the load.

Data Length in Bytes: 2

Data Format: L11

Type: R/W

Default value: Pin strap setting

Units: mV/A

Range: 0 to 40mV/A

FREQUENCY_SWITCH (33h)

Definition: Sets the switching frequency of the device. The initial default value is defined by a pin strap and this value can be overridden by writing this command using PMBus. If an external SYNC is utilized, this value should be set as close as possible to the external clock value. The output must be disabled when writing this command.

Data Length in Bytes: 2

Data Format: L11

Type: R/W

Default Value: Pin strap setting

Units: kHz

Range: 300kHz to 1066kHz

INTERLEAVE (37h)

Definition: Configures the phase offset of a device that is sharing a common SYNC clock with other devices. The phase offset of each device can be set to any value between 0° and 360° in 22.5° increments. The internal two phases of the module always maintain a phase difference of 180°.

Data Length in Bytes: 2

Data Format: BIT

Type: R/W

Default Value: 0000h

Units: N/A

BITS	PURPOSE	VALUE	DESCRIPTION
15:4	Reserved	0	Reserved
3:0	Position in Group	0 to 15	Sets position of the device's rail within the group.

IOUT_CAL_GAIN (38h)

Definition: Sets the effective impedance across the current sense circuit for use in calculating output current at +25°C.

Data Length in Bytes: 2

Data Format: L11

Type: R/W

Default Value: B370h (0.86mΩ)

Units: mΩ

IOUT_CAL_OFFSET (39h)

Definition: Used to null out any offsets in the output current sensing circuit and to compensate for delayed measurements of current ramp due to Isense blanking time.

Data Length in Bytes: 2

Data Format: L11

Type: R/W

Default Value: 0000h (0A)

Units: A

VOUT_OV_FAULT_LIMIT (40h)

Definition: Sets the V_{OUT} overvoltage fault threshold.

Data Length in Bytes: 2

Data Format: L16u

Type: R/W

Default Value: 1.15xVOUT_COMMAND pin strap setting

Units: V

Range: 0V to VOUT_MAX

VOUT_OV_FAULT_RESPONSE (41h)

Definition: Configures the V_{OUT} overvoltage fault response. Note that the device cannot be set to ignore this fault mode.

Data Length in Bytes: 1

Data Format: BIT

Type: R/W

Default Value: 80h (Disable and no retry)

Units: N/A

SETTINGS	ACTIONS
80h	Disable with no retry.
BFh	Disable and continuous retry with 70ms delay.

VOUT_OV_WARN_LIMIT (42h)

Definition: Sets the V_{OUT} overvoltage warning threshold. The power-good signal is pulled low when output voltage goes higher than this threshold.

Data Length in Bytes: 2

Data Format: L16u

Type: R/W

Default Value: 1.10xVOUT_COMMAND pin strap setting

Units: V

Range: 0V to VOUT_MAX

VOUT_UV_WARN_LIMIT (43h)

Definition: Sets the V_{OUT} undervoltage warning threshold. The power-good signal is pulled low when output voltage goes lower than this threshold.

Data Length in Bytes: 2

Data Format: L16u

Type: R/W

Default Value: 0.90xVOUT_COMMAND pin strap setting

Units: V

Range: 0V to VOUT_MAX

VOUT_UV_FAULT_LIMIT (44h)

Definition: Sets the V_{OUT} undervoltage fault threshold. This fault is masked during ramp or when disabled.

Data Length in Bytes: 2

Data Format: L16u

Type: R/W

Default Value: 0.85xVOUT_COMMAND pin strap setting

Units: V

Range: 0V to VOUT_MAX

VOUT_UV_FAULT_RESPONSE (45h)

Definition: Configures the V_{OUT} undervoltage fault response.

Data Length in Bytes: 1

Data Format: BIT

Type: R/W

Default Value: 80h (Disable, no retry)

Units: N/A

SETTINGS	ACTIONS
80h	Disable with no retry.
BFh	Disable and continuous retry with 70ms delay.

IOUT_OC_FAULT_LIMIT (46h)

Definition: Sets the I_{OUT} average overcurrent fault threshold. The device will automatically calculate the peak inductor overcurrent fault limit for each phase based on the equation: $I_{OUT}(PEAK\ OC\ LIMIT) = (0.5 * I_{OUT_OC_FAULT_LIMIT} + 0.5 * I_{RIPPLE(P-P)}) * 120\%$. A hard bound of 42A is applied to the peak overcurrent fault limit per phase.

Data Length in Bytes: 2

Data Format: L11

Type: R/W

Default Value: E3C0h (60A)

Units: A

Range: -100 to 100A

IOUT_UC_FAULT_LIMIT (4Bh)

Definition: Sets the I_{OUT} average undercurrent fault threshold. The device will automatically calculate the valley inductor undercurrent fault limit for each phase based on the equation: $I_{OUT}(VALLEY\ UC\ LIMIT) = (0.5 * I_{OUT_UC_FAULT_LIMIT} - 0.5 * I_{RIPPLE(P-P)}) * 120\%$. A hard bound of -42A is applied to the valley undercurrent fault limit per phase.

Data Length in Bytes: 2

Data Format: L11

Type: R/W

Default Value: -1xIOUT_OC_FAULT_LIMIT

Units: A

Range: -100 to 100A

OT_FAULT_LIMIT (4Fh)

Definition: Sets the temperature at which the device should indicate an over-temperature fault. Note that the temperature must drop below OT_WARN_LIMIT to clear this fault.

Data Length in Bytes: 2

Data Format: L11

Type: R/W

Default Value: EBE8h (+125°C)

Units: Celsius

Range: 0°C to +175°C

OT_FAULT_RESPONSE (50h)

Definition: Instructs the device on what action to take in response to an over-temperature fault.

Data Length in Bytes: 1

Data Format: BIT

Type: R/W

Fault Value: 80h (Disable and no retry)

Units: N/A

SETTINGS	ACTIONS
80h	Disable with no retry.
BFh	Disable and continuous retry with 70ms delay.

OT_WARN_LIMIT (51h)

Definition: Sets the temperature at which the device should indicate an over-temperature warning alarm. In response to the OT_WARN_LIMIT being exceeded, the device sets the TEMPERATURE bit in STATUS_WORD, sets the OT_WARNING bit in STATUS_TEMPERATURE, and notifies the host.

Data Length in Bytes: 2

Data Format: L11

Type: R/W

Default Value: EB48h (+105 °C)

Units: Celsius

Range: 0 °C to +175 °C

UT_WARN_LIMIT (52h)

Definition: Sets the temperature at which the device should indicate an under-temperature warning alarm. In response to the UT_WARN_LIMIT being exceeded, the device sets the TEMPERATURE bit in STATUS_WORD, sets the UT_WARNING bit in STATUS_TEMPERATURE, and notifies the host.

Data Length in Bytes: 2

Data Format: L11

Type: R/W

Default Value: DC40h (-30 °C)

Units: Celsius

Range: -55 °C to +25 °C

UT_FAULT_LIMIT (53h)

Definition: Sets the temperature, in degrees Celsius, of the unit where it should indicate an under-temperature fault. Note that the temperature must rise above UT_WARN_LIMIT to clear this fault.

Data Length in Bytes: 2

Data Format: L11

Type: R/W

Default Value: E580h (-40 °C)

Units: Celsius

Range: -55 °C to +25 °C

UT_FAULT_RESPONSE (54h)

Definition: Configures the under-temperature fault response as defined by the following table. The delay time is the time between restart attempts.

Data Length in Bytes: 1

Data Format: BIT

Type: R/W

Default Value: 80h (Disable, no retry)

Units: N/A

SETTINGS	ACTIONS
80h	Disable with no retry.
BFh	Disable and continuous retry with 70ms delay.

VIN_OV_FAULT_LIMIT (55h)

Definition: Sets the V_{IN} overvoltage fault threshold.

Data Length in Bytes: 2

Data Format: L11

Type: R/W

Default Value: D380h (14V)

Units: V

Range: 0V to 16V

VIN_OV_FAULT_RESPONSE (56h)

Definition: Configures the V_{IN} overvoltage fault response as defined by the following table. The delay time is the time between restart attempts.

Data Length in Bytes: 1

Data Format: BIT

Type: R/W

Default Value: 80h (Disable and no retry)

Units: N/A

SETTINGS	ACTIONS
80h	Disable with no retry.
BFh	Disable and continuous retry with 70ms delay.

VIN_OV_WARN_LIMIT (57h)

Definition: Sets the V_{IN} overvoltage warning threshold. In response to the OV_WARN_LIMIT being exceeded, the device sets the NONE OF THE ABOVE and INPUT bits in STATUS_WORD, sets the VIN_OV_WARNING bit in STATUS_INPUT, and notifies the host.

Data Length in Bytes: 2

Data Format: L11

Type: R/W

Protectable: Yes

Default Value: D353h (13.3V)

Units: V

Range: 0V to 16V

VIN_UV_WARN_LIMIT (58h)

Definition: Sets the V_{IN} undervoltage warning threshold. If a VIN_UV_FAULT occurs, the input voltage must rise above VIN_UV_WARN_LIMIT to clear the fault, which provides hysteresis to the fault threshold. In response to the UV_WARN_LIMIT being exceeded, the device sets the NONE OF THE ABOVE and INPUT bits in STATUS_WORD, sets the VIN_UV_WARNING bit in STATUS_INPUT, and notifies the host.

Data Length in Bytes: 2

Data Format: L11

Type: R/W

Default Value: 1.05 x VIN_UV_FAULT_LIMIT pin strap setting

Units: V

Range: 0V to 12V

VIN_UV_FAULT_LIMIT (59h)

Definition: Sets the V_{IN} undervoltage fault threshold.

Data Length in Bytes: 2

Data Format: L11

Type: R/W

Default Value: Pin strap setting

Units: V

Range: 0V to 12V

VIN_UV_FAULT_RESPONSE (5Ah)

Definition: Configures the V_{IN} undervoltage fault response as defined by the following table. The delay time is the time between restart attempts.

Data Length in Bytes: 1

Data Format: BIT

Type: R/W

Default Value: 80h (Disable and no retry)

Units: N/A

SETTINGS	ACTIONS
80h	Disable with no retry
BFh	Disable and continuous retry with 70ms delay

POWER_GOOD_ON (5Eh)

Definition: Sets the voltage threshold for Power-good indication. Power-good asserts with a delay specified in POWER_GOOD_DELAY after the output voltage exceeds POWER_GOOD_ON and deasserts when the output voltage is less than VOUT_UV_WARN_LIMIT.

Data Length in Bytes: 2

Data Format: L16u

Type: R/W

Default Value: 0.9xVOUT_COMMAND pin strap setting

Units: V

TON_DELAY (60h)

Definition: Sets the delay time from when the device is enabled to the start of V_{OUT} rise.

Data Length in Bytes: 2

Data Format: L11

Type: R/W

Default Value: Pin strap setting

Units: ms

Range: 0 to 500ms

TON_RISE (61h)

Definition: Sets the rise time of V_{OUT} after ENABLE and TON_DELAY. In multi-module current sharing configuration where ASCR is disabled for start up, the rise time of V_{OUT} can be approximately calculated by [Equation 1](#).

Data Length in Bytes: 2

Data Format: L11

Type: R/W

Default Value: Pin strap setting

Units: ms

Range: 0 to 200ms

TOFF_DELAY (64h)

Definition: Sets the delay time from DISABLE to the start of V_{OUT} fall.

Data Length in Bytes: 2

Data Format: L11

Type: R/W

Default Value: Pin strap setting

Units: ms

Range: 0 to 500ms

TOFF_FALL (65h)

Definition: Sets the soft-off fall time for V_{OUT} after DISABLE and TOFF_DELAY.

Data Length in Bytes: 2

Data Format: L11

Type: R/W

Default Value: Pin strap setting

Units: ms

Range: 0 to 200ms

STATUS_BYTE (78h)

Definition: Returns one byte of information with a summary of the most critical faults.

Data Length in Bytes: 1

Data Format: BIT

Type: Read-only

Default Value: 00h

Units: N/A

BIT NUMBER	STATUS BIT NAME	MEANING
7	BUSY	A fault was declared because the device was busy and unable to respond.
6	OFF	This bit is asserted if the unit is not providing power to the output, regardless of the reason, including simply not being enabled.
5	VOUT_OV_FAULT	An output overvoltage fault has occurred.
4	IOUT_OC_FAULT	An output overcurrent fault has occurred.
3	VIN_UV_FAULT	An input undervoltage fault has occurred.
2	TEMPERATURE	A temperature fault or warning has occurred.
1	CML	A communications, memory or logic fault has occurred.
0	NONE OF THE ABOVE	A fault or warning not listed in Bits 7:1 has occurred.

STATUS_WORD (79h)

Definition: Returns two bytes of information with a summary of the unit's fault condition. Based on the information in these bytes, the host can get more information by reading the appropriate status registers. The low byte of the STATUS_WORD is the same register as the STATUS_BYTE (78h) command.

Data Length in Bytes: 2

Data Format: BIT

Type: Read-only

Default Value: 0000h

Units: N/A

BIT NUMBER	STATUS BIT NAME	MEANING
15	VOUT	An output voltage fault or warning has occurred.
14	IOUT/POUT	An output current or output power fault or warning has occurred.
13	INPUT	An input voltage, input current, or input power fault or warning has occurred.
12	MFG_SPECIFIC	A manufacturer specific fault or warning has occurred.
11	POWER_GOOD#	The POWER_GOOD signal, if present, is negated.
10	FANS	A fan or airflow fault or warning has occurred.
9	OTHER	A bit in STATUS_OTHER is set.
8	UNKNOWN	A fault type not given in bits 15:1 of the STATUS_WORD has been detected.
7	BUSY	A fault was declared because the device was busy and unable to respond.
6	OFF	This bit is asserted if the unit is not providing power to the output, regardless of the reason, including simply not being enabled.
5	VOUT_OV_FAULT	An output overvoltage fault has occurred.
4	IOUT_OC_FAULT	An output overcurrent fault has occurred.
3	VIN_UV_FAULT	An input undervoltage fault has occurred.
2	TEMPERATURE	A temperature fault or warning has occurred.
1	CML	A communications, memory or logic fault has occurred.
0	NONE OF THE ABOVE	A fault or warning not listed in Bits 7:1 has occurred.

STATUS_VOUT (7Ah)

Definition: Returns one data byte with the status of the output voltage.

Data Length in Bytes: 1

Data Format: BIT

Type: Read-only

Default Value: 00h

Units: N/A

BIT NUMBER	STATUS BIT NAME	MEANING
7	VOUT_OV_FAULT	Indicates an output overvoltage fault.
6	VOUT_OV_WARNING	Indicates an output overvoltage warning.
5	VOUT_UV_WARNING	Indicates an output undervoltage warning.
4	VOUT_UV_FAULT	Indicates an output undervoltage fault.
3:0	N/A	These bits are not used.

STATUS_IOUT (7Bh)

Definition: Returns one data byte with the status of the output current.

Data Length in Bytes: 1

Data Format: BIT

Type: Read-only

Default Value: 00h

Units: N/A

BIT NUMBER	STATUS BIT NAME	MEANING
7	IOUT_OC_FAULT	An output overcurrent fault has occurred.
6	IOUT_OC_LV_FAULT	An output overcurrent and low voltage fault has occurred.
5	IOUT_OC_WARNING	An output overcurrent warning has occurred.
4	IOUT_UC_FAULT	An output undercurrent fault has occurred.
3:0	N/A	These bits are not used.

STATUS_INPUT (7Ch)

Definition: Returns input voltage and input current status information.

Data Length in Bytes: 1

Data Format: BIT

Type: Read-only

Default Value: 00h

Units: N/A

BIT NUMBER	STATUS BIT NAME	MEANING
7	VIN_OV_FAULT	An input overvoltage fault has occurred.
6	VIN_OV_WARNING	An input overvoltage warning has occurred.
5	VIN_UV_WARNING	An input undervoltage warning has occurred.
4	VIN_UV_FAULT	An input undervoltage fault has occurred.
3:0	N/A	These bits are not used.

STATUS_TEMP (7Dh)

Definition: Returns one byte of information with a summary of any temperature related faults or warnings.

Data Length in Bytes: 1

Data Format: BIT

Type: Read-only

Default Value: 00h

Units: N/A

BIT NUMBER	STATUS BIT NAME	MEANING
7	OT_FAULT	An over-temperature fault has occurred.
6	OT_WARNING	An over-temperature warning has occurred.
5	UT_WARNING	An under-temperature warning has occurred.
4	UT_FAULT	An under-temperature fault has occurred.
3:0	N/A	These bits are not used.

STATUS_CML (7Eh)

Definition: Returns one byte of information with a summary of any communications, logic, and/or memory errors.

Data Length in Bytes: 1

Data Format: BIT

Type: Read-only

Default Value: 00h

Units: N/A

BIT NUMBER	MEANING
7	Invalid or unsupported PMBus command was received.
6	The PMBus command was sent with invalid or unsupported data.
5	packet error was detected in the PMBus command.
4:2	Not Used
1	A PMBus command tried to write to a read-only or protected command, or a communication fault other than the ones listed in this table has occurred.
0	Not Used

STATUS_MFR_SPECIFIC (80h)

Definition: Returns one byte of information providing the status of the device's voltage monitoring and clock synchronization faults.

Data Length in Bytes: 1

Data Format: BIT

Type: Read only

Default value: 00h

Units: N/A

BIT NUMBER	FIELD NAME	MEANING
7:6	Reserved	Reserved.
5	VMON UV Warning	The voltage on the VMON pin has dropped below 4V.
4	VMON OV Warning	The voltage on the VMON pin has risen above 5.9V.
3	External Switching Period Fault	Loss of external clock synchronization has occurred.
2	Reserved	Reserved.
1	VMON UV Fault	The voltage on the VMON pin has dropped below the level set by VMON_UV_FAULT_LIMIT.
0	VMON OV Fault	The voltage on the VMON pin has risen above the level set by VMON_OV_FAULT_LIMIT.

READ_VIN (88h)

Definition: Returns the input voltage reading.

Data Length in Bytes: 2

Data Format: L11

Type: Read-only

Units: V

READ_VOUT (8Bh)

Definition: Returns the output voltage reading.

Data Length in Bytes: 2

Data Format: L16u

Type: Read-only

Units: V

READ_IOUT (8Ch)

Definition: Returns the output current reading.

Data Length in Bytes: 2

Data Format: L11

Type: Read-only

Default Value: N/A

Units: A

READ_INTERNAL_TEMP (8Dh)

Definition: Returns the controller junction temperature reading from internal temperature sensor.

Data Length in Bytes: 2

Data Format: L11

Type: Read-only

Units: °C

READ_DUTY_CYCLE (94h)

Definition: Reports the actual duty cycle of the converter during the enable state.

Data Length in Bytes: 2

Data Format: L11

Type: Read only

Units: %

READ_FREQUENCY (95h)

Definition: Reports the actual switching frequency of the converter during the enable state.

Data Length in Bytes: 2

Data Format: L11

Type: Read only

Units: kHz

READ_IOUT_0 (96h)

Definition: Returns the Phase 1 current reading.

Data Length in Bytes: 2

Data Format: L11

Type: Read-only

Default Value: N/A

Units: A

READ_IOUT_1 (97h)

Definition: Returns the Phase 2 current reading.

Data Length in Bytes: 2

Data Format: L11

Type: Read-only

Default Value: N/A

Units: A

MFR_ID (99h)

Definition: Sets user defined identification. The sum total of characters in MFR_ID, MFR_MODEL, MFR_REVISION, MFR_LOCATION, MFR_DATE, MFR_SERIAL and USER_DATA_00 plus one byte per command cannot exceed 128 characters. This limitation includes multiple writes of this command before a STORE command. To clear multiple writes, perform a RESTORE, write this command, then perform a STORE/RESTORE.

Data Length in Bytes: user defined

Data Format: ASCII

Type: Block R/W

Default Value: null

Units: N/A

MFR_MODEL (9Ah)

Definition: Sets a user defined model. The sum total of characters in MFR_ID, MFR_MODEL, MFR_REVISION, MFR_LOCATION, MFR_DATE, MFR_SERIAL, and USER_DATA_00 plus one byte per command cannot exceed 128 characters. This limitation includes multiple writes of this command before a STORE command. To clear multiple writes, perform a RESTORE, write this command, then perform a STORE/RESTORE.

Data Length in Bytes: user defined

Data Format: ASC

Type: Block R/W

Default Value: null

Units: N/A

MFR_REVISION (9Bh)

Definition: Sets a user defined revision. The sum total of characters in MFR_ID, MFR_MODEL, MFR_REVISION, MFR_LOCATION, MFR_DATE, MFR_SERIAL, and USER_DATA_00 plus one byte per command cannot exceed 128 characters. This limitation includes multiple writes of this command before a STORE command. To clear multiple writes, perform a RESTORE, write this command, then perform a STORE/RESTORE.

Data Length in Bytes: user defined

Data Format: ASC

Type: Block R/W

Default Value: null

Units: N/A

MFR_LOCATION (9Ch)

Definition: Sets a user defined location identifier. The sum total of characters in MFR_ID, MFR_MODEL, MFR_REVISION, MFR_LOCATION, MFR_DATE, MFR_SERIAL and USER_DATA_00 plus one byte per command cannot exceed 128 characters. This limitation includes multiple writes of this command before a STORE command. To clear multiple writes, perform a RESTORE, write this command, then perform a STORE/RESTORE.

Data Length in Bytes: User defined

Data Format: ASC

Type: Block R/W

Default Value: null

Units: N/A

MFR_DATE (9Dh)

Definition: Sets a user defined date. The sum total of characters in MFR_ID, MFR_MODEL, MFR_REVISION, MFR_LOCATION, MFR_DATE, MFR_SERIAL and USER_DATA_00 plus one byte per command cannot exceed 128 characters. This limitation includes multiple writes of this command before a STORE command. To clear multiple writes, perform a RESTORE, write this command, then perform a STORE/RESTORE.

Data Length in Bytes: User defined

Data Format: ASC

Type: Block R/W

Default Value: null

Units: N/A

Reference: N/A

MFR_SERIAL (9Eh)

Definition: Sets a user defined serialized identifier. The sum total of characters in MFR_ID, MFR_MODEL, MFR_REVISION, MFR_LOCATION, MFR_DATE, MFR_SERIAL, and USER_DATA_00 plus one byte per command cannot exceed 128 characters. This limitation includes multiple writes of this command before a STORE command. To clear multiple writes, perform a RESTORE, write this command, then perform a STORE/RESTORE.

Data Length in Bytes: User defined

Data Format: ASC

Type: Block R/W

Default Value: null

Units: N/A

LEGACY_FAULT_GROUP (A8h)

Definition: Specifies which rail DDC IDs should be listened to for fault spreading with legacy devices. The data sent is a 4-byte, 32-bit, bit vector where every bit represents a rail's DDC ID. A bit set to 1 indicates a device DDC ID to which the configured device will respond upon receiving a fault spreading event. In this vector, bit 0 of byte 0 corresponds to the rail with DDC ID 0. Following through, Bit 7 of byte 3 corresponds to the rail with DDC ID 31.

Data Length in Bytes: 4

Data Format: BIT

Type: R/W

Default Value: 00000000h

USER_DATA_00 (B0h)

Definition: Sets user defined data. The sum total of characters in MFR_ID, MFR_MODEL, MFR_REVISION, MFR_LOCATION, MFR_DATE, MFR_SERIAL, and USER_DATA_00 plus one byte per command cannot exceed 128 characters. This limitation includes multiple writes of this command before a STORE command. To clear multiple writes, perform a RESTORE, write this command, then perform a STORE/RESTORE.

Data Length in Bytes: User defined

Data Format: ASCII

Type: Block R/W

Default Value: null

Units: N/A

ISENSE_CONFIG (D0h)

Definition: Configures current sense circuitry.

Data Length in Bytes: 1

Data Format: BIT

Type: R/W

Default Value: 05h

Units: N/A

BIT	FIELD NAME	VALUE	SETTING	DESCRIPTION
7:4	Reserved	000		
3:2	Current Sense Blanking Time	00	192ns	Sets the blanking time current sense blanking time.
		01	256ns	
		10	412ns	
		11	640ns	
1:0	Current Sense Range	00	Low Range	±25mV
		01	Mid Range	±35mV
		10	High Range	±50mV
		11	Not Used	

USER_CONFIG (D1h)

Definition: Configures several user-level features. This command overrides the CONFIG pin settings.

Data Length in Bytes: 1

Data Format: BIT

Type: R/W

Default Value: Pin strap setting

Units: N/A

BIT	FIELD NAME	VALUE	SETTING	DESCRIPTION
7	ASCR on for Start up	0	Disabled	ASCR is disabled for start up. Use this for current sharing mode.
		1	Enabled	ASCR is enabled for start up. Use this for stand alone mode.
6:5	Reserved	0		Reserved
4:3	Ramp-Up and Ramp-Down Minimum Duty Cycle	00	0.39%	Sets the minimum duty-cycle during start-up and shutdown ramp.
		01	0.78%	
		10	1.17%	
		11	1.56%	
2	Minimum Duty Cycle Control	0	Disable	Control for minimum duty cycle.
		1	Enable	
1	Power-Good Pin Configuration	0	Open Drain	0 = PG is open drain output.
		1	Push-Pull	1 = PG is push-pull output.
0	Reserved	0		

DDC_CONFIG (D3h)

Definition: Configures DDC addressing and current sharing. With pin strap for stand alone configuration, the DDC rail ID is set according to the SMBus address. With pin strap for multi-module current sharing, the DDC rail ID is set according to the number of devices. Device position and number of devices in the rail can be programmed as needed.

Data Length in Bytes: 2

Data Format: BIT

Type: R/W

Default Value: Pin strap setting

Units: N/A

BIT	FIELD NAME	VALUE	SETTING	DESCRIPTION
15:13	Device Position	0, 1, 2, 3		Sets the device position in a current sharing rail. 0-Position 1 1-Position 2 2-Position 3 3-Position 4
12:8	Rail ID	0 to 31 (00 to 1Fh)		Configures the DDC rail ID.
7:4	Reserved	0	Reserved	Reserved
3	Device Internal Phase Difference	0, 1		Sets the internal phase difference of the phase. The 0-phase difference is 180°. The 1-phase difference is 0°.
2:0	Number of Devices in Rail	1, 3, 5, 7		Identifies the number of devices in a current sharing rail. 1-standalone 3-two devices 5-three devices 7-four devices

POWER_GOOD_DELAY (D4h)

Definition: Sets the delay applied between the output exceeding the PG threshold (POWER_GOOD_ON) and asserting the PG pin. The delay time can range from 0ms up to 500s, in steps of 125ns. A 1ms minimum configured value is recommended to apply proper de-bounce to this signal.

Data Length in Bytes: 2

Data Format: L11

Type: R/W

Default Value: 3ms

Units: ms

Range: 0 to 5s

ASCR_CONFIG (DFh)

Definition: Allows user configuration of ASCR settings. ASCR Gain is analogous to bandwidth and ASCR Residual is analogous to damping. To improve load transient response performance, increase ASCR Gain. To lower transient response overshoot, increase ASCR Residual. Increasing ASCR gain can result in increased PWM jitter and should be evaluated in the application circuit. Excessive ASCR gain can lead to excessive output voltage ripple. Increasing ASCR Residual to improve transient response damping can result in slower recovery times, but will not affect the peak output voltage deviation. Typical ASCR Gain settings range from 50 to 1000 and ASCR Residual settings range from 10 to 100.

Data Length in Bytes: 4

Data Format: CUS

Type: R/W

Default Value: Pin strap setting

BIT	PURPOSE	DATA Format	VALUE	DESCRIPTION
31:25	Unused		0000000h	Unused
24	ASCR Enable	BIT	1	Enable
			0	Disable
23:16	ASCR Residual Setting	Integer		ASCR residual
15:0	ASCR Gain Setting	Integer		ASCR gain

SEQUENCE (E0h)

Definition: Identifies the Rail DDC ID of the prequel and sequel rails when performing multi-rail sequencing. The device will enable its output when its EN or OPERATION enable states, as defined by ON_OFF_CONFIG, are set and the prequel device has issued a Power-Good event on the DDC bus. The device will disable its output (using the programmed delay values) when the sequel device has issued a Power-Down event on the DDC bus.

The data field is a two-byte value. The most-significant byte contains the 5-bit Rail DDC ID of the prequel device. The least-significant byte contains the 5-bit Rail DDC ID of the sequel device. The most significant bit of each byte contains the enable of the prequel or sequel mode. This command overrides the corresponding sequence configuration set by the CONFIG pin settings.

Data Length in Bytes: 2

Data Format: BIT

Type: R/W

Default Value: 0000h (Prequel and Sequel disabled)

BIT	FIELD NAME	VALUE	SETTING	DESCRIPTION
15	Prequel Enable	0	Disable	Disable, no prequel preceding this rail.
		1	Enable	Enable, prequel to this rail is defined by bits 12:8.
14:13	Reserved	0	Reserved	Reserved
12:8	Prequel Rail DDC ID	0-31	DDC ID	Set to the DDC ID of the prequel rail.
7	Sequel Enable	0	Disable	Disable, no sequel following this rail.
		1	Enable	Enable, sequel to this rail is defined by bits 4:0.
6:5	Reserved	0	Reserved	Reserved
4:0	Sequel Rail DDC ID	0-31	DDC ID	Set to the DDC ID of the sequel rail.

DDC_GROUP (E2h)

Definition: Configures fault spreading group ID and enable, broadcast OPERATION group ID and enable, and broadcast VOUT_COMMAND group ID and enable.

Data Length in Bytes: 3

Data Format: BIT

Type: R/W

Default Value: Pin strap setting (ignore BROADCAST VOUT_COMMAND, OPERATIONn and fault for stand alone operation. Enable BROADCAST VOUT_COMMAND, OPERATION, and fault for current sharing).

BITS	PURPOSE	VALUE	DESCRIPTION
23:22	Reserved	0	Reserved
21	BROADCAST_VOUT_COMMAND Response	1	Responds to BROADCAST_VOUT_COMMAND with same Group ID.
		0	Ignores BROADCAST_VOUT_COMMAND.
20:16	BROADCAST_VOUT_COMMAND Group ID	0-31d	Group ID sent as data for broadcast BROADCAST_VOUT_COMMAND events.
15:14	Reserved	0	Reserved
13	BROADCAST_OPERATION Response	1	Responds to BROADCAST_OPERATION with same Group ID.
		0	Ignores BROADCAST_OPERATION.
12:8	BROADCAST_OPERATION Group ID	0-31d	Group ID sent as data for broadcast BROADCAST_OPERATION events.
7:6	Reserved	0	Reserved
5	POWER_FAIL Response	1	Responds to POWER_FAIL events with same Group ID by shutting down immediately.
		0	Responds to POWER_FAIL events with same Group ID with sequenced shutdown.
4:0	POWER_FAIL group ID	0-31d	Group ID sent as data for broadcast POWER_FAIL events.

DEVICE_ID (E4h)

Definition: Returns the 16-byte (character) device identifier string.

Data Length in Bytes: 16

Data Format: ASCII

Type: Block Read

Default Value: Part number/Die revision/Firmware revision

MFR_IOUT_OC_FAULT_RESPONSE (E5h)

Definition: Configures the IOUT overcurrent fault response as defined by the following table. The command format is the same as the PMBus standard fault responses except that it sets the overcurrent status bit in STATUS_IOUT.

Data Length in Bytes: 1

Data Format: BIT

Type: R/W

Default Value: 80h (Disable and no retry)

Units: N/A

SETTINGS	ACTIONS
80h	Disable with no retry.
BFh	Disable and continuous retry with 70ms delay.

MFR_IOUT_UC_FAULT_RESPONSE (E6h)

Definition: Configures the I_{OUT} undercurrent fault response as defined by the following table. The command format is the same as the PMBus standard fault responses except that it sets the undercurrent status bit in STATUS_IOUT.

Data Length in Bytes: 1

Data Format: BIT

Type: R/W

Default Value: 80h (Disable and no retry)

Units: N/A

SETTINGS	ACTIONS
80h	Disable with no retry.
BFh	Disable and continuous retry with 70ms delay.

SYNC_CONFIG (E9h)

Definition: Sets options for SYNC output configurations.

Data Length in Bytes: 1

Data Format: BIT

Type: R/W

Default Value: Pin strap setting

SETTINGS	ACTIONS
00h	Use Internal clock. Clock frequency is set by pin strap or PMBus command.
02h	Use internal clock and output internal clock.
04h	Use external clock.

SNAPSHOT (EAh)

Definition: A 32-byte read-back of parametric and status values. It allows monitoring and status data to be stored to flash following a fault condition. In case of a fault, the last updated values are stored to the flash memory. When the SNAPSHOT STATUS bit is set stored, device will no longer automatically capture parametric and status values following fault until stored data are erased. Use the SNAPSHOT_CONTROL command to erase store data and clear the status bit before next ramp up. Data erased is not allowed when the module is enabled.

Data Length in Bytes: 32

Data Format: Bit field

Type: Block Read

BYTE NUMBER	VALUE	PMBUS COMMAND	FORMAT
31:23	Reserved	Reserved	00h
22	Flash Memory Status Byte FF - Not Stored 00 - Stored	N/A	BIT
21	Manufacturer Specific Status Byte	STATUS_MFR_SPECIFIC (80h)	Byte
20	CML Status Byte	STATUS_CML (7Eh)	Byte
19	Temperature Status Byte	STATUS_TEMPERATURE (7Dh)	Byte
18	Input Status Byte	STATUS_INPUT (7Ch)	Byte
17	I _{OUT} Status Byte	STATUS_IOUT (7Bh)	Byte
16	V _{OUT} Status Byte	STATUS_VOUT (7Ah)	Byte
15:14	Switching Frequency	READ_FREQUENCY (95h)	L11
13:12	Reserved	Reserved	00h
11:10	Internal Temperature	READ_INTERNAL_TEMP (8Dh)	L11
9:8	Duty Cycle	READ_DUTY_CYCLE (94h)	L11
7:6	Highest Measured Output Current	N/A	L11
5:4	Output Current	READ_IOUT (8Ch)	L11
3:2	Output Voltage	READ_VOUT (8Bh)	L16u
1:0	Input Voltage	READ_VIN (88h)	L11

BLANK_PARAMS (EBh)

Definition: Returns a 16-byte string indicating which parameter values were either retrieved by the last RESTORE operation or have been written since that time. Reading BLANK_PARAMS immediately after a restore operation allows the user to determine which parameters are stored in that store. A one indicates the parameter is not present in the store and has not been written since the RESTORE operation.

Data Length in Bytes: 16

Data Format: BIT

Type: Block Read

Default Value: FF...FFh

SNAPSHOT_CONTROL (F3h)

Definition: Writing a 01h will cause the device to copy the current SNAPSHOT values from NVRAM to the 32-byte SNAPSHOT command parameter. Writing a 02h will cause the device to write the current SNAPSHOT values to NVRAM, and writing a 03h will erase all SNAPSHOT values from NVRAM. Write (02h) and Erase (03h) may only be used when the device is disabled. All other values are ignored.

Data Length in Bytes: 1

Data Format: Bit field

Type: R/W byte

VALUE	DESCRIPTION
01h	Read SNAPSHOT values from NV RAM
02h	Write SNAPSHOT values to NV RAM
03h	Erase SNAPSHOT values stored in NV RAM.

RESTORE_FACTORY (F4h)

Definition: Restores the device to the hard-coded Factory default values and pin strap definitions. The device retains the DEFAULT and USER stores for restoring. Security level is changed to Level 1 following this command.

Data Length in Bytes: 0

Data Format: N/A

Type: Write only

Default Value: N/A

Units: N/A

MFR_VMON_OV_FAULT_LIMIT (F5h)

Definition: Reads the VMON OV fault threshold.

Data Length in Bytes: 2

Data Format: L11

Type: Read only

Default Value: CB00h (6V)

Units: V

Range: 4V to 6V

MFR_VMON_UV_FAULT_LIMIT (F6h)

Definition: Reads the VMON UV fault threshold.

Data Length in Bytes: 2

Data Format: L11

Type: Read only

Default Value: CA00h (4V)

Units: V

Range: 4V to 6V

MFR_READ_VMON (F7h)

Definition: Reads the VMON voltage.

Data Length in Bytes: 2

Data Format: L11

Type: Read only

Default Value: N/A

Units: V

Range: 4V to 6V

VMON_OV_FAULT_RESPONSE (F8h)

Definition: Reads the VMON OV fault response.

Data Length in Bytes: 1

Data Format: BIT

Type: Read only

Default Value: 80h (Disable and no retry)

Units:

VMON_UV_FAULT_RESPONSE (F9h)

Definition: Reads the VMON UV fault response, which follows VIN_UV_FAULT_RESPONSE.

Data Length in Bytes: 1

Data Format: BIT

Type: Read only

Default Value: 80h (Disable and no retry)

Units: V

Firmware Revision History

TABLE 10. ISL8272M NOMENCLATURE GUIDE

FIRMWARE REVISION CODE	CHANGE DESCRIPTION	NOTE
ISL8272-000-FC02	<ul style="list-style-type: none"> - Enhanced fault management during start-up - Enhanced IOOUT UC fault management during start-up - Enhanced PMBus immunity to noise and lockup - Added paged ISENGain and ISENOffset factors which are storable in default memory - Added temperature compensation for the paged ISENGain and ISENOffset factors and reduced temperature drift - Improved intra-device current balance within the two internal phases - Fixed the synchronization issue during VOUT_COMMAND change on-the-fly current sharing conditions - Added more pin-strap resistor settings for the CS pin for four-module current sharing conditions - Added the capability to change the device internal phase difference from 180° to 0° in DDC_CONFIG and optimized module-to-module phase shift in Current Sharing mode - VMON UV/OV warning value changed 	Recommended for new designs
ISL8272-000-FC01	Initial Release	Not recommended for new designs

Revision History The revision history provided is for informational purposes only and is believed to be accurate, but not warranted. Please visit our website to make sure you have the latest revision.

DATE	REVISION	CHANGE
Nov 8, 2017	FN8670.5	<p>Added clock configurations to Table 9, Current Sharing Resistor Settings on page 22.</p> <p>STATUS_MFR_SPECIFIC (80h) PMBus command on page 41 - updated command definition and the meanings of Bits 4 and 5.</p> <p>DDC_CONFIG (D3h) PMBus command on page 45 - updated bit descriptions.</p> <p>Added Firmware Revision B (FC02) to Firmware Revision History on page 51 and firmware graphic on page 3.</p> <p>Renumbered figures to fix issue in which Figure 4 was listed twice.</p>
Mar 31, 2017	FN8670.4	<p>Related Literature on page 1 updated.</p> <p>Ordering Information, page 3: Updated Note 2 - added Tape and Reel option and Note 3 - added exemptions 7C-I and 7A.</p> <p>Added the notation "A standard 1% resistor is required" to the following sections:</p> <ul style="list-style-type: none"> -Soft-Start/Stop Delay and Ramp Times, Switching Frequency and PLL, Loop Compensation, Input Undervoltage Lockout (UVLO), SMBus Module Address Selection, Active Current Sharing <p>Added "Note that fault retry is not supported in the current sharing configuration." to the following sections:</p> <ul style="list-style-type: none"> Input Undervoltage Lockout (UVLO), Output Overvoltage Protection, Output Overcurrent Protection, Thermal Overload Protection, Active Current Sharing, Fault Spreading ("Note that fault retry is not supported in multiple modules with fault spreading enabled, such as the current sharing configuration."). <p>SMBus Communications section on page 17, paragraph added (3rd paragraph)</p> <p>Soft-Start/Stop Delay and Ramp Times section page 17 - a paragraph was added (1st paragraph)</p> <p>PMBus Use Guidelines - added "Commands not listed in the PMBus command summary are not allowed for customer use, and are reserved for factory use only. Issuing reserved commands may result in unexpected operation."</p> <p>POD Y58.18x23 revised from rev 1 to rev 3. Changes since rev 1:</p> <ol style="list-style-type: none"> 1) Pages 1 and 2 of POD Y58.18x23 remain unchanged for this update. 2) Deleted remaining pages 3-5 of existing POD and replaced with: New drawings - 2 drawings per page <p>On page 2, in the "Size Details for the 16 Exposed Pads" (Bottom View) changed dimension 8.40 (2X) to 8.30 (2x) and 8.00 (2x) to 1.00 (2X).</p>
Mar 16, 2016	FN8670.3	<p>Added "PMBus Use Guidelines" on page 29.</p> <p>Updated POD Y58.18x23 to the latest revision changes are as follows:</p> <ul style="list-style-type: none"> -Detail A on page 1: Added Reference Radius for rounded corners on small I/O pads.
Jan 14, 2015	FN8670.2	<p>"Electrical Specifications" on page 10 under VOUT_ACCY and VOUT_READ_ERR: Updated unit value from "% FS" to "%VOUT".</p> <p>Updated "Switching Frequency and PLL" on page 18.</p>
Sep 17, 2014	FN8670.1	<p>Removed the words "in forced CCM Mode" from 2nd paragraph on page 1, which read "The ISL8272M operated in forced CCM Mode with the ChargeMode™ control architecture,..."</p>
Sep 12, 2014	FN8670.0	Initial release

About Intersil

Intersil Corporation is a leading provider of innovative power management and precision analog solutions. The company's products address some of the largest markets within the industrial and infrastructure, mobile computing, and high-end consumer markets.

For the most updated datasheet, application notes, related documentation and related parts, please see the respective product information page found at www.intersil.com.

For a listing of definitions and abbreviations of common terms used in our documents, visit: www.intersil.com/glossary.

You may report errors or suggestions for improving this datasheet by visiting www.intersil.com/ask.

Reliability reports are also available from our website at www.intersil.com/support.

© Copyright Intersil Americas LLC 2014-2017. All Rights Reserved.
All trademarks and registered trademarks are the property of their respective owners.

For additional products, see www.intersil.com/en/products.html

Intersil products are manufactured, assembled and tested utilizing ISO9001 quality systems as noted in the quality certifications found at www.intersil.com/en/support/qualandreliability.html

Intersil products are sold by description only. Intersil may modify the circuit design and/or specifications of products at any time without notice, provided that such modification does not, in Intersil's sole judgment, affect the form, fit or function of the product. Accordingly, the reader is cautioned to verify that datasheets are current before placing orders. Information furnished by Intersil is believed to be accurate and reliable. However, no responsibility is assumed by Intersil or its subsidiaries for its use; nor for any infringements of patents or other rights of third parties which may result from its use. No license is granted by implication or otherwise under any patent or patent rights of Intersil or its subsidiaries.

For information regarding Intersil Corporation and its products, see www.intersil.com

Package Outline Drawing

Y58.18x23

58 I/O 18mmx23mmx7.5mm CUSTOM HDA MODULE

Rev 3, 12/16

For the most recent package

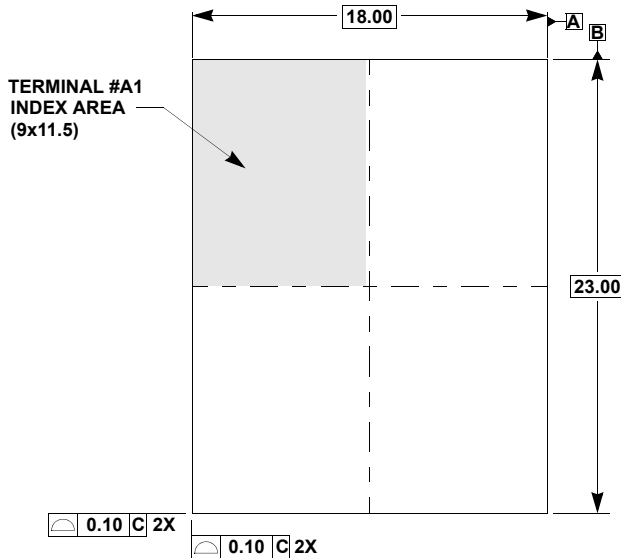

TOP VIEW

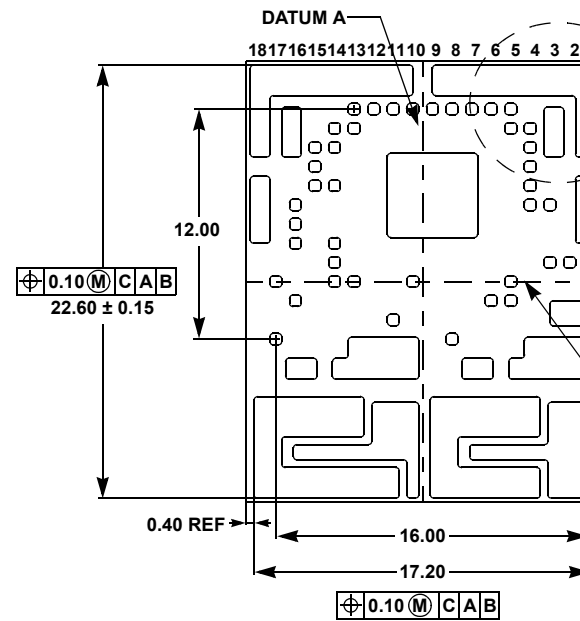

BOTTOM VIEW

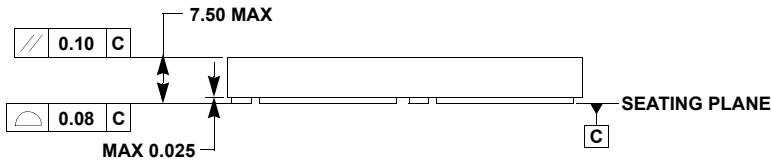

SIDE VIEW

NOTES:

1. All dimensions are in millimeters.
2. Represents the basic land grid pitch.
3. These 42 I/Os are centered in a fixed row and column matrix at 1.0mm pitch BSC.
4. Dimensioning and tolerancing per ASME Y14.5-2009.
5. Tolerance for exposed PAD edge location dimension on page 3 is ± 0.1 mm.

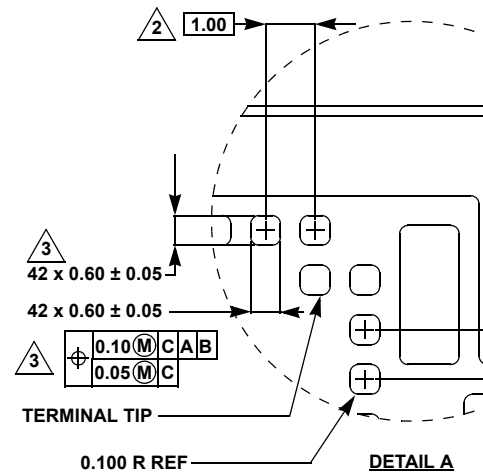

DETAIL A

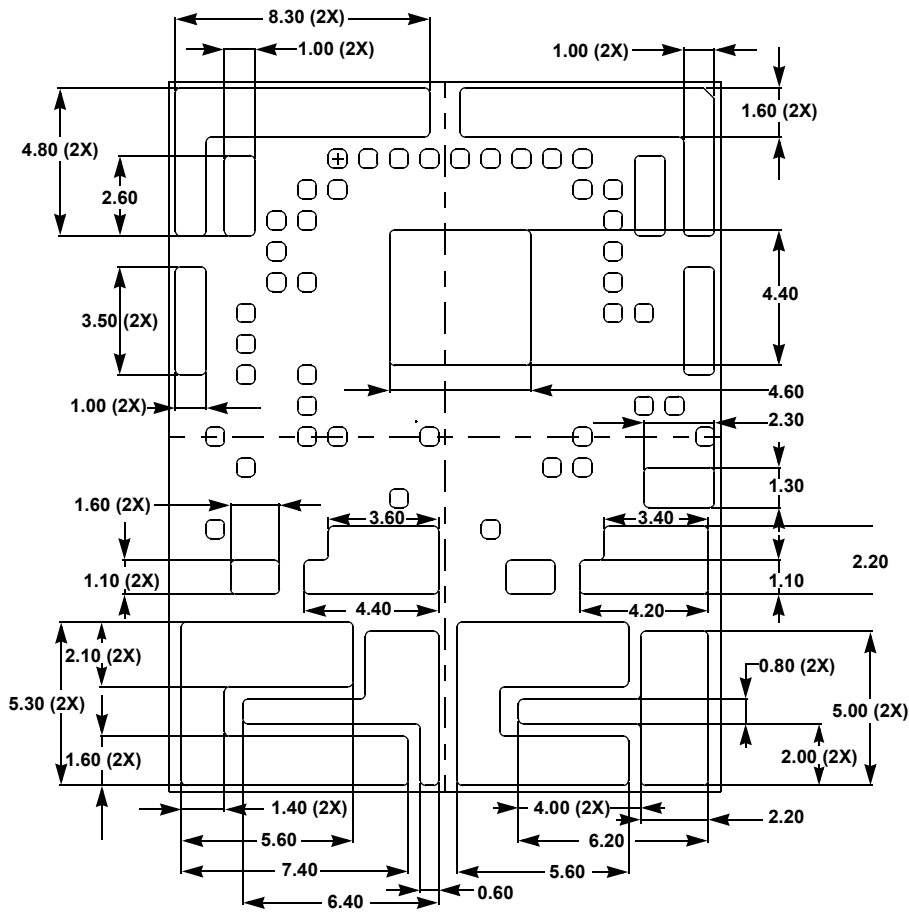

SIZE DETAILS FOR THE 16 EXPOSED PADS

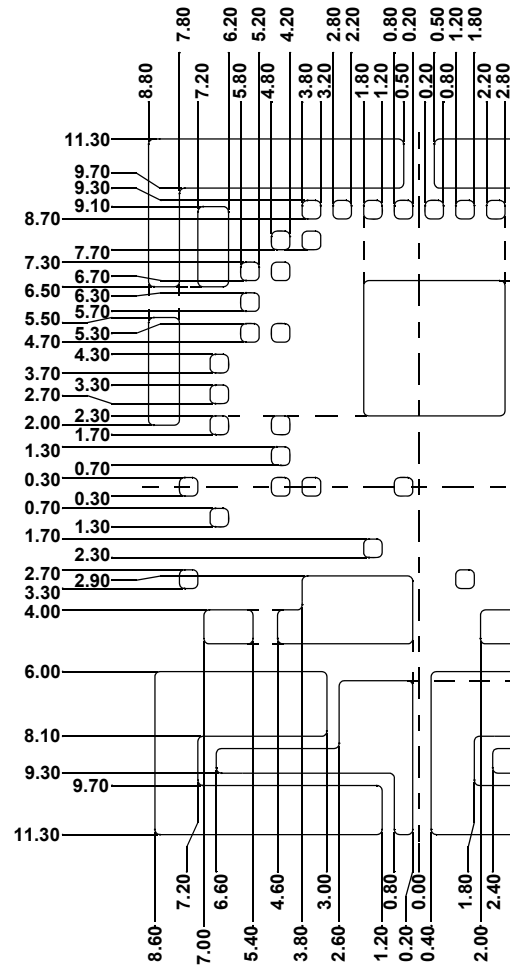

TERMINAL AND PAD EDGE DIMENSIONS

BOTTOM VIEW

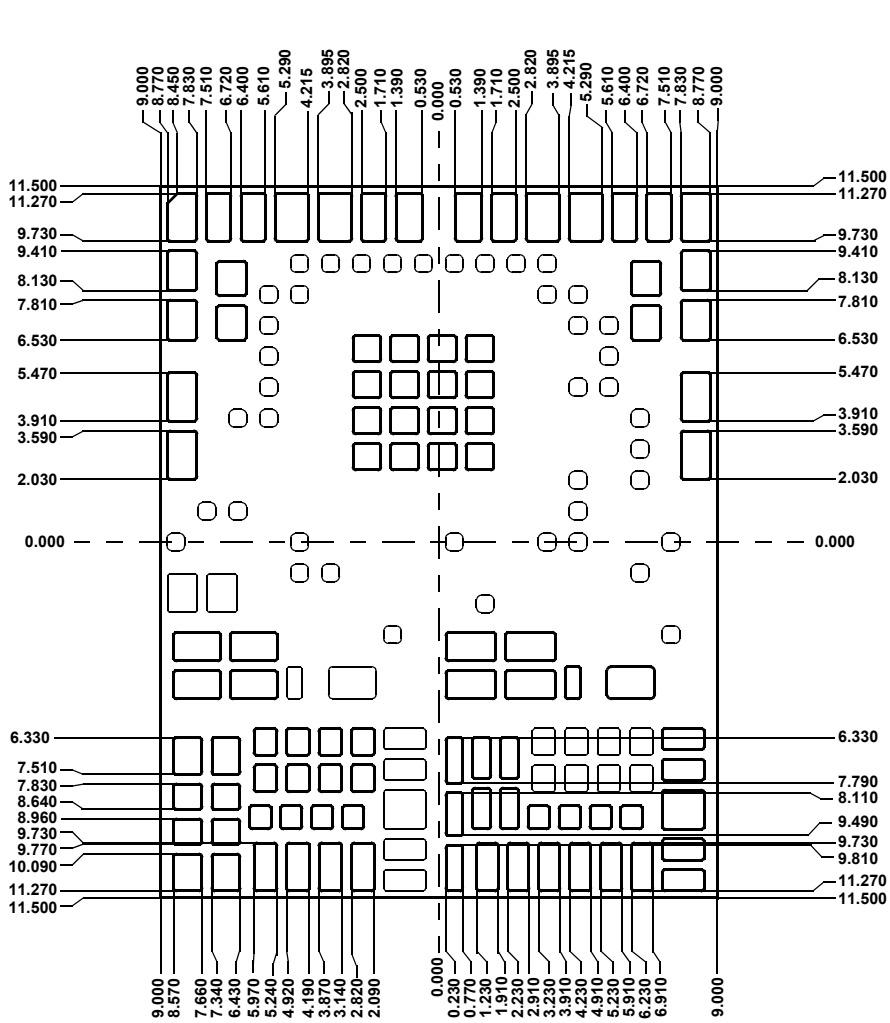

STENCIL OPENING EDGE POSITION - 1

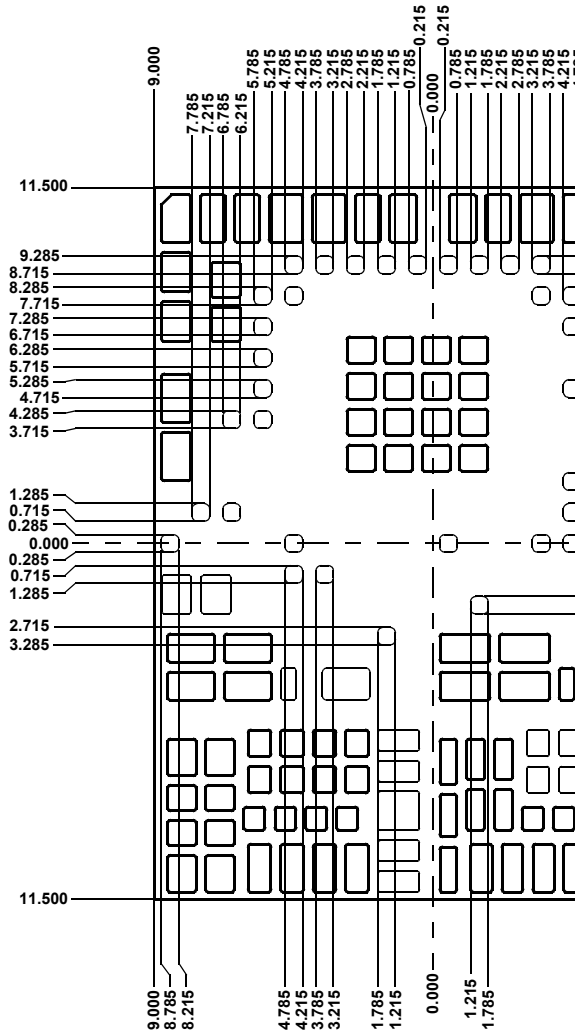

STENCIL OPENING EDGE POSITION

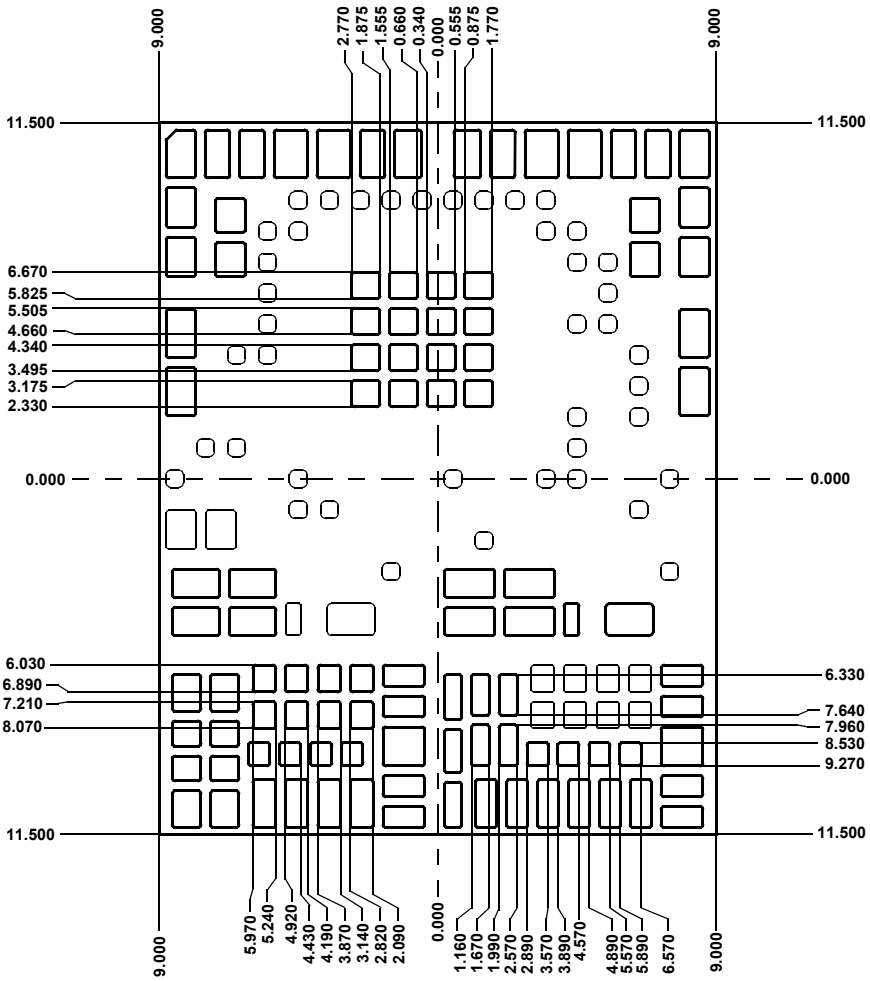

STENCIL OPENING EDGE POSITION - 3

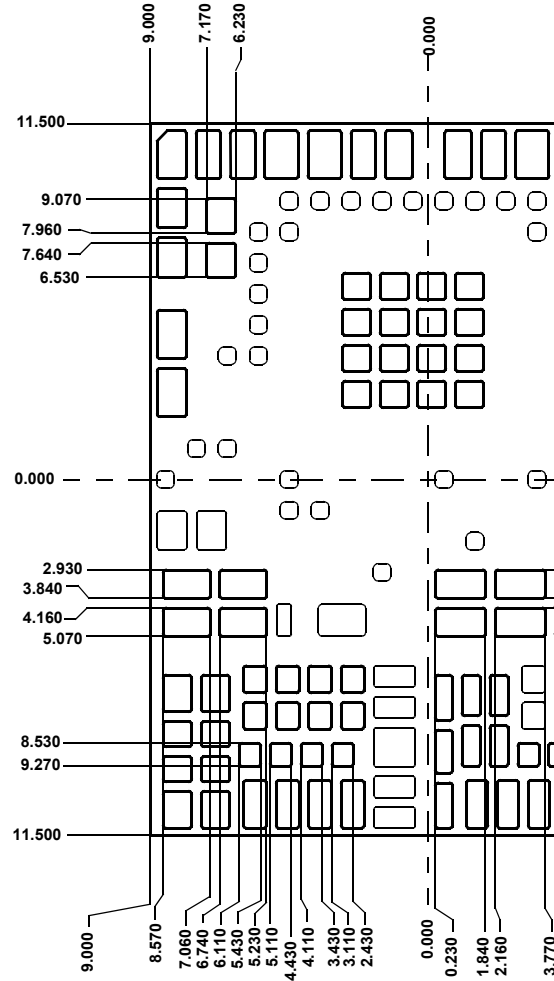

STENCIL OPENING EDGE POSITION - 4

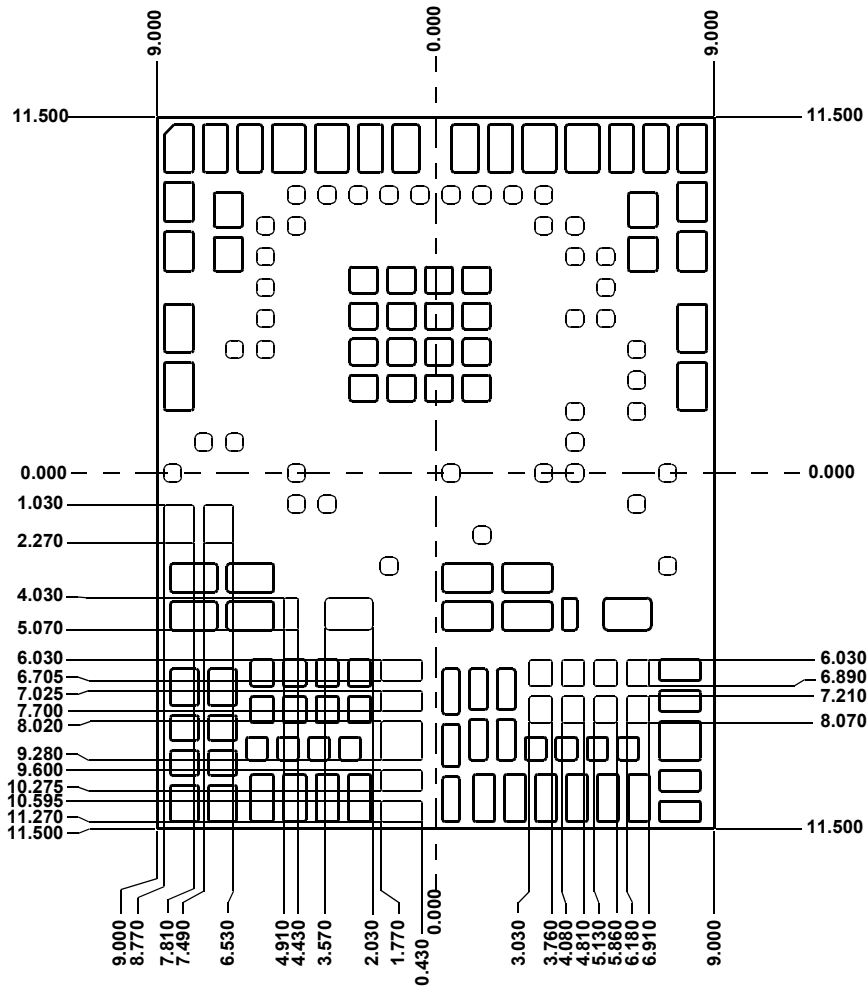

STENCIL OPENING EDGE POSITION - 5

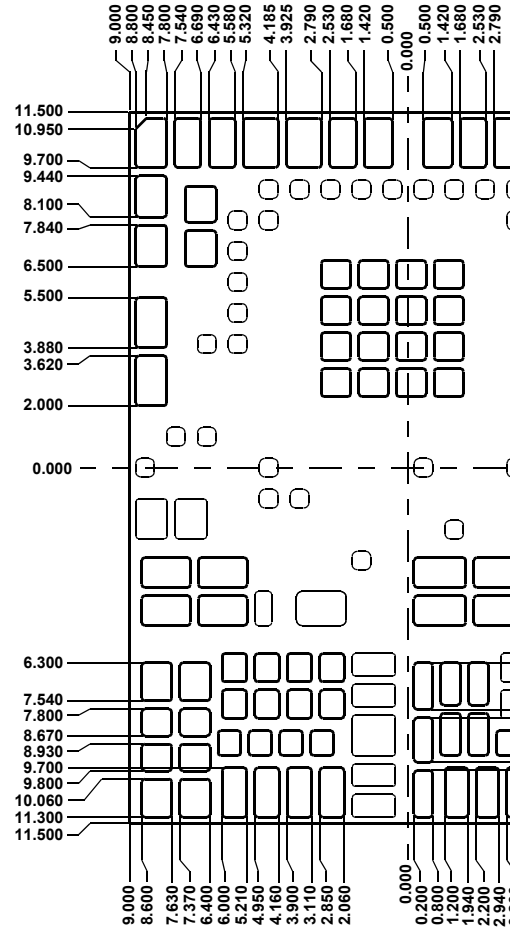

PCB LAND PATTERN - 1 (FOR REF)

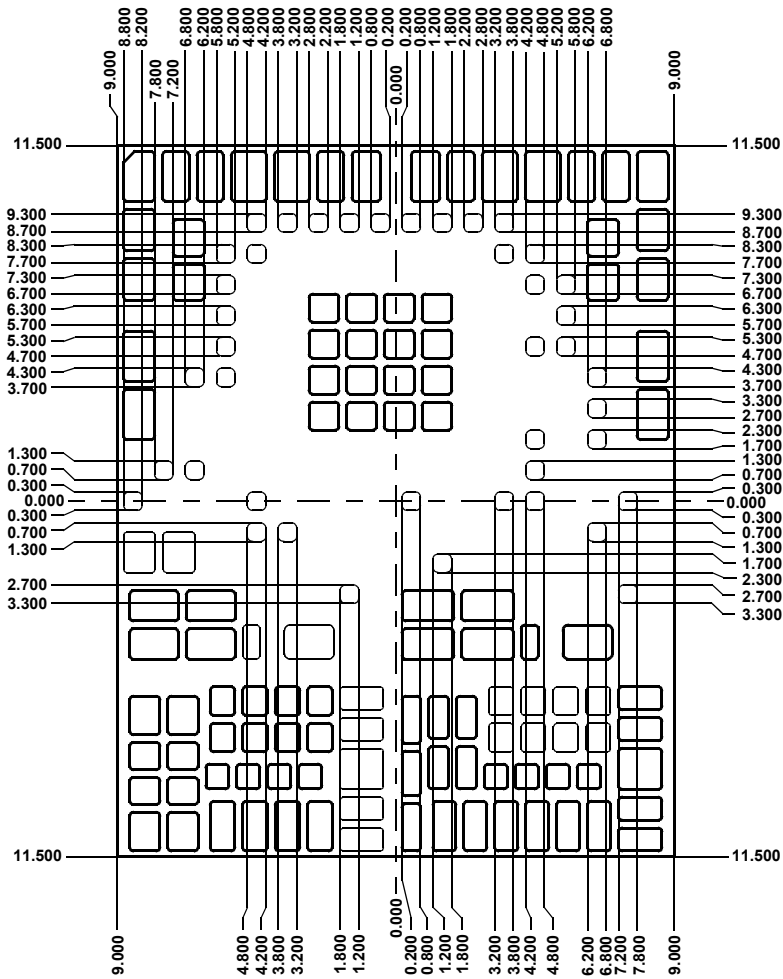

PCB LAND PATTERN - 2 (FOR REFERENCE)

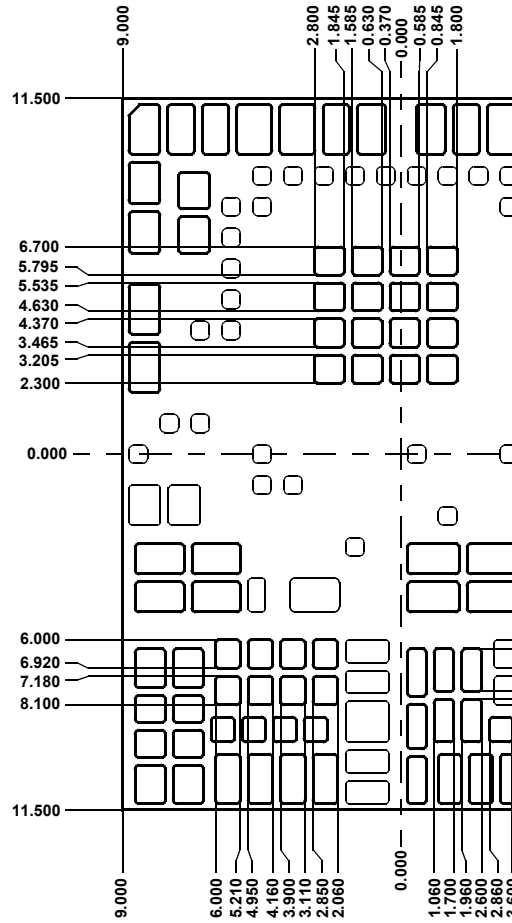

PCB LAND PATTERN - 3 (FOR REFERENCE)

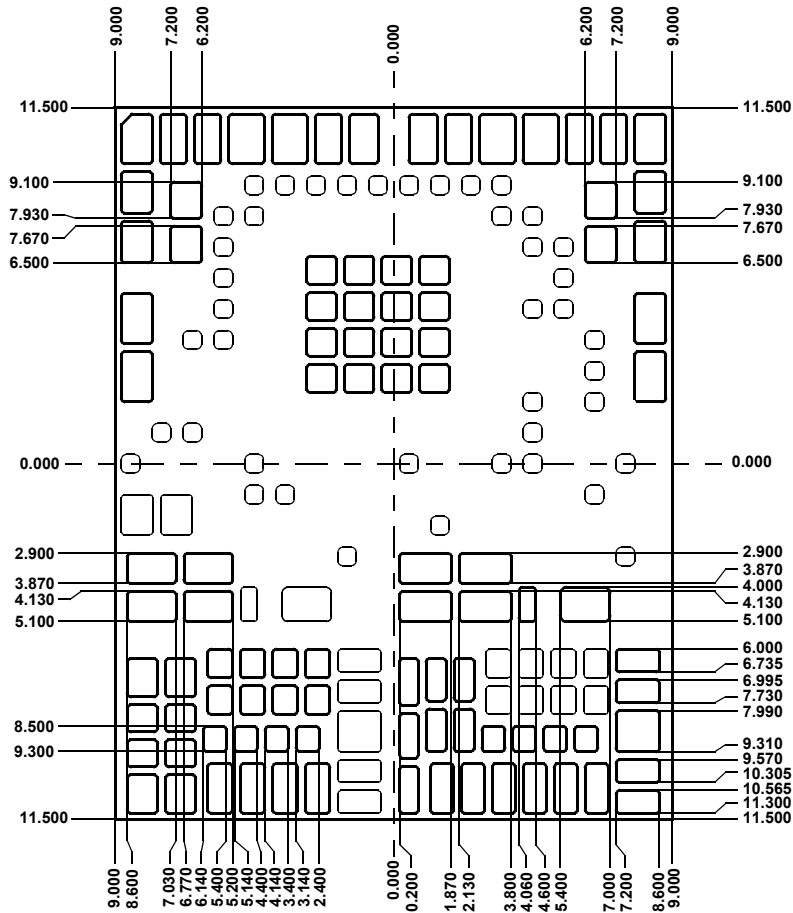

PCB LAND PATTERN - 4 (FOR REFERENCE)

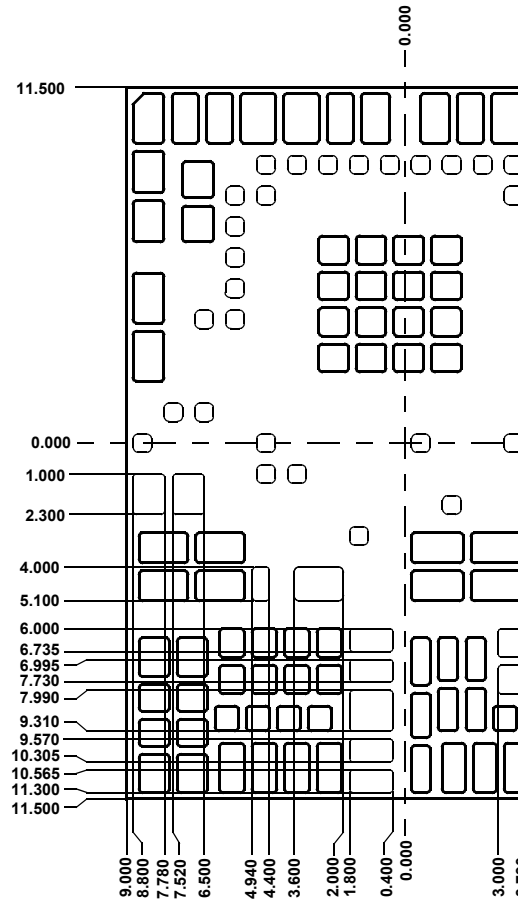

PCB LAND PATTERN - 5 (FOR REFERENCE)

X-ON Electronics

Largest Supplier of Electrical and Electronic Components

Click to view similar products for [Voltage Regulators - Switching Regulators](#) category:

Click to view products by [Renesas](#) manufacturer:

Other Similar products are found below :

[LX7186A](#) [622616F](#) [632259F](#) [FAN53610AUC33X](#) [MP2148GQD-33-P](#) [MP2374DS-LF-Z](#) [EN6310QA](#) [NCP81108MNTXG](#)
[NCP81109BMNTXG](#) [L79M05TL-E](#) [FAN48610BUC45X](#) [R3](#) [LV5710GP-TE-L-H](#) [430464BB](#) [455605G](#) [AZ7500BMTR-E1](#) [MIC23156-](#)
[0YML-T5](#) [MIC4930YFL-T5](#) [MP8763GLE-P](#) [KE177614](#) [418569H](#) [455596X](#) [511087D](#) [030908C](#) [063375FB](#) [067501FB](#) [099508GB](#)
[EP5358LUA](#) [NCP81102MNTXG](#) [715715H](#) [FAN48611UC53X](#) [FAN53611AUC12X](#) [MAX809TTR](#) [MAX77596ETBC+T](#)
[MAX77596ETBB+T](#) [MAX16905AUE/V+](#) [NCP6332CMTAATBG](#) [NCV890203MWTXG](#) [LX7176A](#) [MP2162AGQH-Z](#) [MAX17544ATP+T](#)
[EN6360QI](#) [MCP1623T-IMC](#) [MCP1642B-18IMC](#) [MCP1642BT-30I/MS](#) [MCP1642D-50IMC](#) [MCP1642D-50IMS](#) [MCP1642D-ADJIMC](#)
[MC34063LBBGEVB](#) [MCP1252T-33X50IMS](#)