

## IV2D12020D2Z – 1200V 20A Automotive SiC Schottky Diode

### Features

- Max Junction Temperature 175°C
- High Surge Current Capacity
- Extremely Fast Reverse Recovery Time
- Reduced Losses in Associated MOSFET
- High-Frequency Operation
- Temperature Independent Switching Behavior
- Positive Temperature Coefficient on  $V_F$
- AEC-Q101 qualified

### Outline

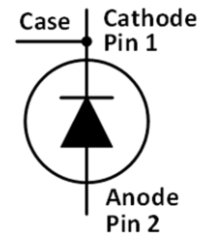
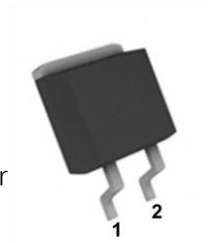

TO263-2

### Applications

- Automotive Inverter Free Wheeling Diodes
- EV Charger Piles
- Vienna 3-Phase PFC
- Solar Power Boost
- Switch Mode Power Supplies

### Marking Diagram

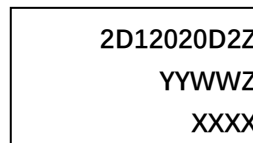

2D12020D2Z= Specific Device Code  
 YY = Year  
 WW = Work Week  
 Z = Assembly Location  
 XXXX = Lot Traceability

### Absolute Maximum Ratings (Tc=25°C unless otherwise specified)

Symbol	Parameter	Value	Unit
$V_{RRM}$	Reverse voltage (repetitive peak)	1200	V
$V_{DC}$	DC blocking voltage	1200	V
$I_F$	Forward current (continuous) @Tc=25°C	43.0	A
	Forward current (continuous) @Tc=135°C	20.3	A
	Forward current (continuous) @Tc=135.4°C	20	A
$I_{FSM}$	Surge non-repetitive forward current sine halfwave @Tc=25°C tp=10ms	155	A
$I_{FRM}$	Surge repetitive forward current (Freq=0.1Hz, 100cycles) sine halfwave @Tamb=25°C tp=10ms	125	A
$P_{tot}$	Total power dissipation @ Tc=25°C	166	W
	Total power dissipation @ Tc=150°C	27.7	
$\int i^2 dt$	$i^2t$ value @Tc=25°C tp=10ms	120	A <sup>2</sup> s
Tstg	Storage temperature range	-55 to 175	°C
Tj	Operating junction temperature range	-55 to 175	°C

Stresses exceeding those listed in the Maximum Ratings table may damage the device. If any of these limits are exceeded, device functionality should not be assumed, damage may occur and reliability may be affected.

## Electrical Characteristics

Symbol	Parameter	Typ.	Max.	Unit	Test Conditions	Note
V <sub>F</sub>	Forward Voltage	1.48	1.80	V	I <sub>F</sub> = 20 A T <sub>J</sub> =25°C	Fig. 1
		2.20	3.00		I <sub>F</sub> = 20 A T <sub>J</sub> =175°C	
I <sub>R</sub>	Reverse Current	8	150	μA	V <sub>R</sub> = 1200 V T <sub>J</sub> =25°C	Fig. 2
		50	800		V <sub>R</sub> = 1200 V T <sub>J</sub> =175°C	
C	Total Capacitance	1000		pF	V <sub>R</sub> = 1 V, T <sub>J</sub> = 25°C, f = 1 MHz	Fig. 3
		89			V <sub>R</sub> = 400 V, T <sub>J</sub> = 25°C, f = 1 MHz	
		66			V <sub>R</sub> = 800 V, T <sub>J</sub> = 25°C, f = 1 MHz	
Q <sub>C</sub>	Total Capacitive Charge	94		nC	V <sub>R</sub> = 800 V, T <sub>J</sub> = 25°C, $Q_C = \int_0^{V_R} C(V) dV$	Fig. 4
E <sub>C</sub>	Capacitance Stored Energy	27		μJ	V <sub>R</sub> = 800 V, T <sub>J</sub> = 25°C, $E_C = \int_0^{V_R} C(V) \cdot V dV$	Fig. 5

## Thermal Characteristics

Symbol	Parameter	Typ.	Unit	Note
R <sub>th(j-c)</sub>	Thermal Resistance from Junction to Case	0.9	°C/W	Fig.7

## Typical Performance

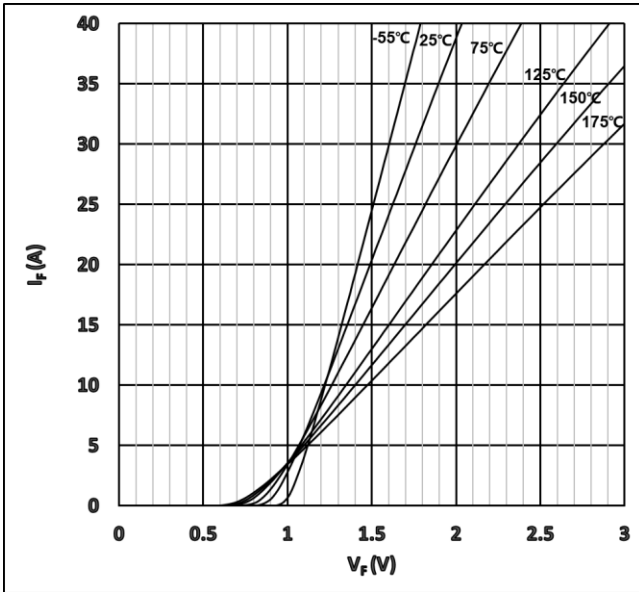

Figure 1. Typical Forward Characteristics

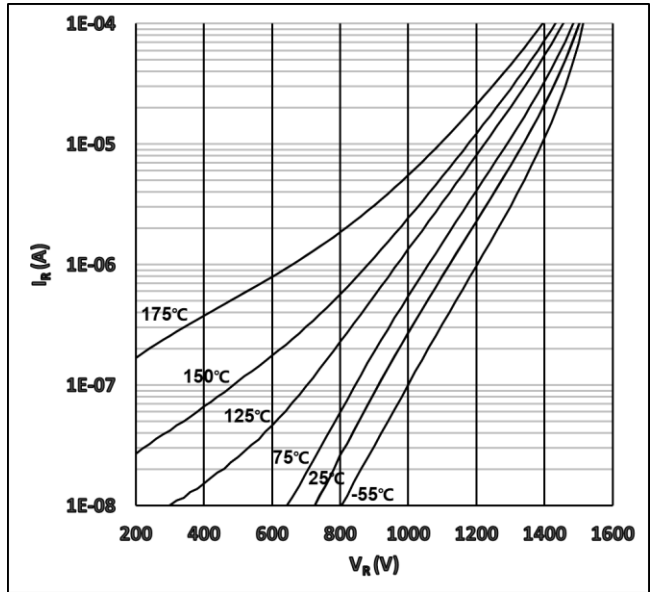

Figure 2. Typical Reverse Characteristics

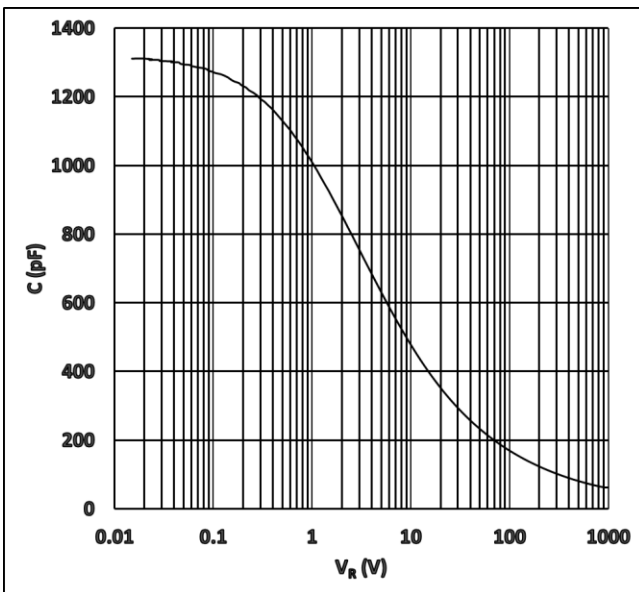

Figure 3. Capacitance vs. Reverse Voltage

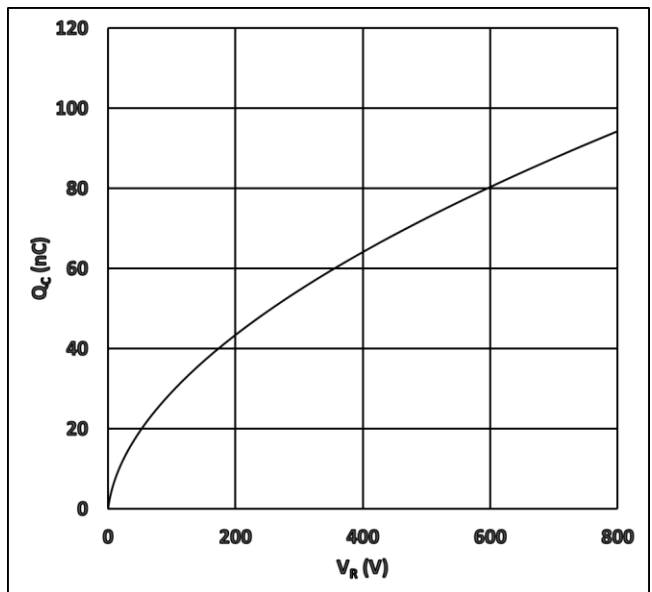

Figure 4. Recovery Charge vs. Reverse Voltage

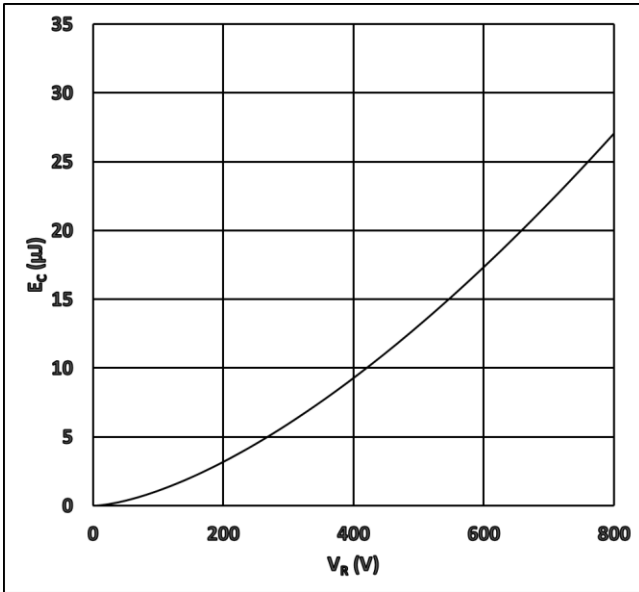

Figure 5. Capacitance Stored Energy

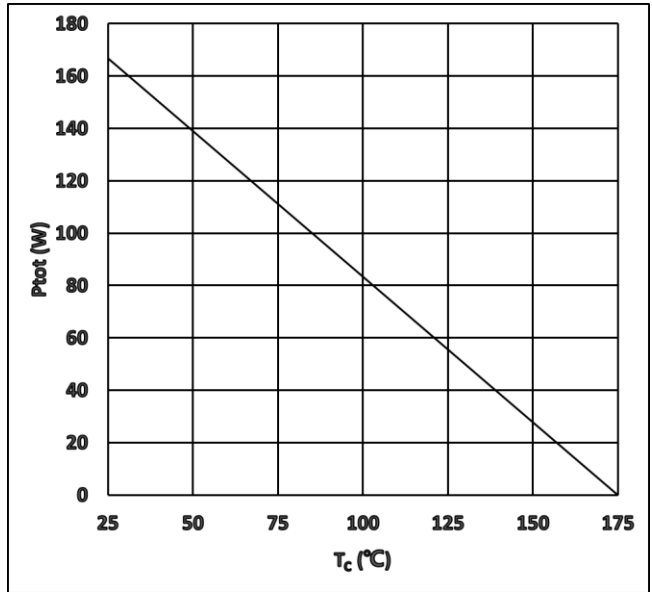

Figure 6. Power Derating

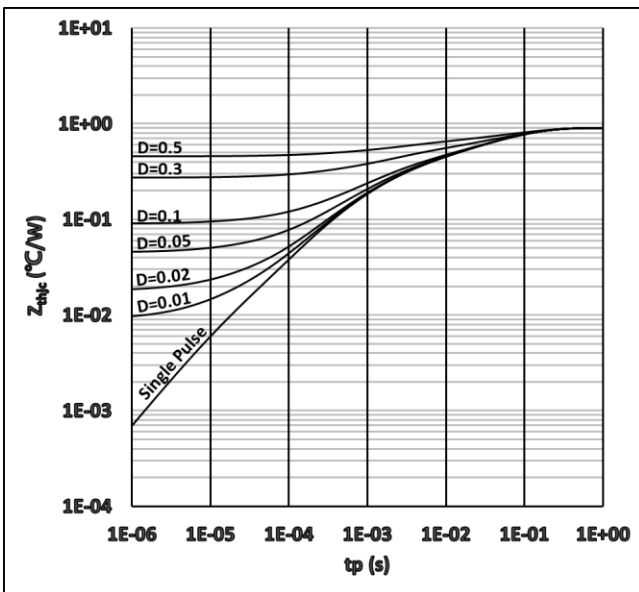

Figure 7. Transient Thermal Impedance

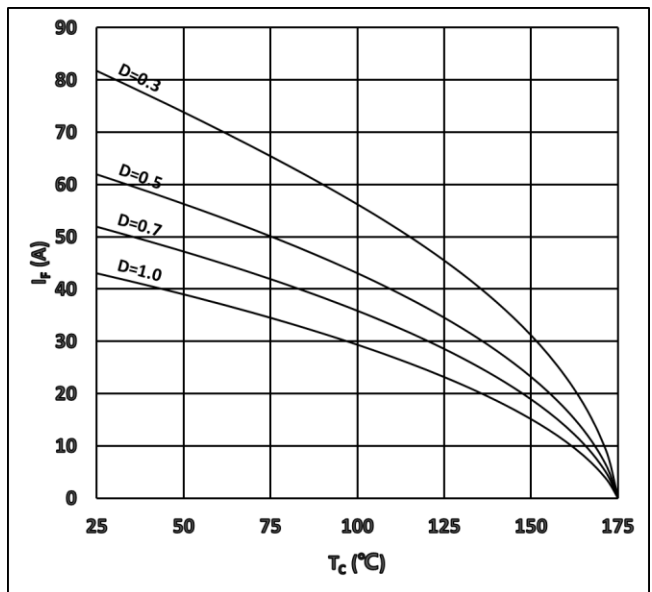
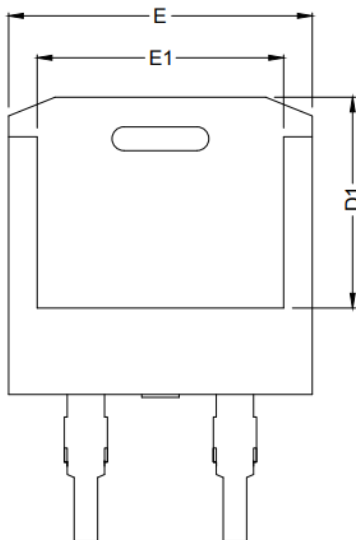
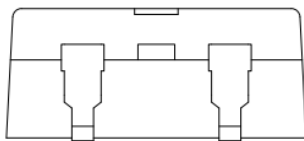
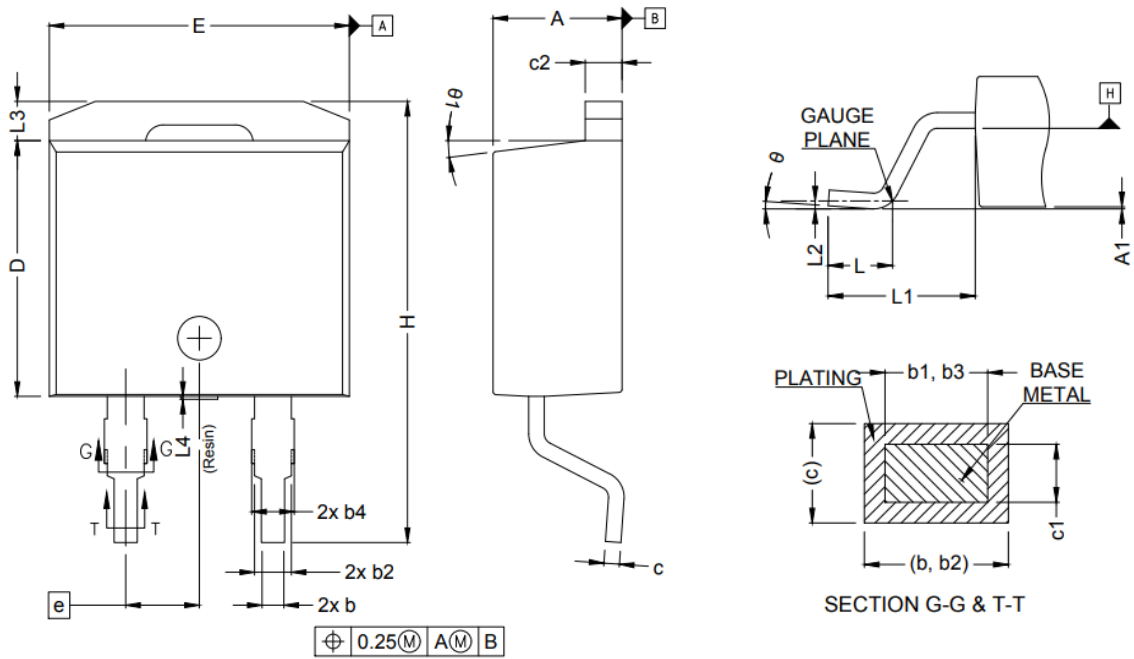

Figure 8.  $I_F$  as a Function of Temp.

## Package Dimensions



SYMBOL	MIN.	MAX.	SYMBOL	MIN.	MAX.
A	4.36	4.56	E	10.15	10.55
A1	0.00	0.25	E1	8.10	8.70
b	0.70	0.90	e	2.54 BSC	
b1	0.51	0.89	H	15.00	15.60
b2	1.20	1.46	L	1.90	2.50
b3	1.17	1.37	L1	4.78	5.28
b4	1.20	1.57	L2	0.25 TYP	
c	0.38	0.69	L3	1.05	1.65
c1	0.38	0.53	L4	0	0.50
c2	1.19	1.34	$\theta$	0°	10°
D	8.60	9.00	$\theta$ 1	0°	15°
D1	6.90	7.50			

### Note:

1. Dimensioning & Tolerancing Confirm to ASME Y14.5M-1994.
2. All Dimensions are in mm. Angles are in Degrees.
3. Radius on Terminal is Optional.
4. Subject to Change Without Notice.

## Notes

For further information please contact IVCT's Sales Office.

Copyright©2023 InventChip Technology Co., Ltd. All rights reserved.

The information in this document is subject to change without notice.

## Related Links

<http://www.inventchip.com.cn>



## X-ON Electronics

Largest Supplier of Electrical and Electronic Components

*Click to view similar products for [Schottky Diodes & Rectifiers](#) category:*

*Click to view products by [InventChip](#) manufacturer:*

Other Similar products are found below :

[MA4E2039](#) [MMBD301M3T5G](#) [HFA35HB60C](#) [RB160M-50TR](#) [D83C](#) [BAS16E6433HTMA1](#) [BAS 3010S-02LRH](#) [E6327](#) [BAT 54-02LRH](#)  
[E6327](#) [NRVBAF360T3G](#) [NSR05F40QNXT5G](#) [NTE555](#) [JANS1N6640](#) [SS3003CH-TL-E](#) [GA01SHT18](#) [CRS10I30A\(TE85L,QM](#)  
[MBRA140TRPBF](#) [MBRB30H30CT-1G](#) [BAT 15-04R](#) [E6152](#) [JANTX1N5712-1](#) [DMJ3940-000](#) [SB007-03C-TB-E](#) [NRVBB20100CTT4G](#)  
[NRVBM120LT1G](#) [NTSB30U100CT-1G](#) [CRG04\(T5L,TEMQ\)](#) [ACDBA1100LR-HF](#) [ACDBA1200-HF](#) [ACDBA240-HF](#) [ACDBA3100-HF](#)  
[CDBQC0530L-HF](#) [ACDBA260LR-HF](#) [ACDBA1100-HF](#) [10BQ015-M3/5BT](#) [NRVBM120ET1G](#) [VSSB410S-M3/5BT](#) [1N5819T-G](#)  
[PDS1040Q-13](#) [B160BQ-13-F](#) [SDM05U20CSP-7](#) [BAS 70-07](#) [E6433](#) [B140S1F-7](#) [HSM560Je3/TR13](#) [DDB2265-000](#) [ZHCS506QTA](#)  
[HSM190Je3/TR13](#) [B330AF-13](#) [ACDBUC0230-HF](#) [SDM1U100S1F-7](#) [MBR10200CTF-G1](#) [CDLL5712](#)