

IV2Q12030D7Z – 1200V 30mΩ Gen2 Automotive SiC MOSFET

Features

- 2nd Generation SiC MOSFET Technology with +18V gate drive
- High blocking voltage with low on-resistance
- High speed switching with low capacitance
- High operating junction temperature capability
- Very fast and robust intrinsic body diode
- Kelvin gate input easing driver circuit design

Applications

- Motor drivers
- Solar inverters
- Automotive DC/DC converters
- Automotive compressor inverters
- Switch mode power supplies

Outline:

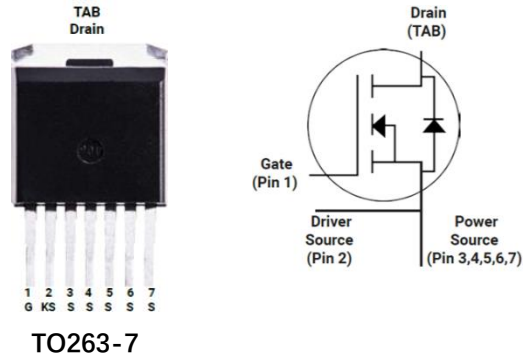

Marking Diagram:

YYWWZ XXXX 2Q12030D7Z	2Q12030D7Z = Specific Device Code YY = Year WW = Work Week Z = Assembly Location XXXX = Lot Traceability
-----------------------------	--

Absolute Maximum Ratings (T_c=25°C unless otherwise specified)

Symbol	Parameter	Value	Unit	Test Conditions	Note
V _{DS}	Drain-Source voltage	1200	V	V _{GS} =0V, I _D =100μA	
V _{GSmax} (DC)	Maximum DC voltage	-5 to 20	V	Static (DC)	
V _{GSmax} (Spike)	Maximum spike voltage	-10 to 23	V	Duty cycle<1%, and pulse width<200ns	
V _{GSon}	Recommended turn-on voltage	18±0.5	V		
V _{GSoff}	Recommended turn-off voltage	-3.5 to -2	V		
I _D	Drain current (continuous)	79	A	V _{GS} =18V, T _c =25°C	Fig. 23
		58	A	V _{GS} =18V, T _c =100°C	
I _{DM}	Drain current (pulsed)	198	A	Pulse width limited by SOA	Fig. 26
P _{TOT}	Total power dissipation	395	W	T _c =25°C	Fig. 24
T _{stg}	Storage temperature range	-55 to 175	°C		
T _J	Operating junction temperature	-55 to 175	°C		
T _L	Solder Temperature	260	°C	wave soldering only allowed at leads, 1.6mm from case for 10 s	

Thermal Data

Symbol	Parameter	Value	Unit	Note
R _{θ(j-c)}	Thermal Resistance from Junction to Case	0.38	°C/W	Fig. 23

Electrical Characteristics ($T_c=25^\circ\text{C}$ unless otherwise specified)

Symbol	Parameter	Value			Unit	Test Conditions	Note
		Min.	Typ.	Max.			
I_{DSS}	Zero gate voltage drain current		5	100	μA	$V_{DS}=1200\text{V}, V_{GS}=0\text{V}$	
I_{GSS}	Gate leakage current			± 100	nA	$V_{DS}=0\text{V}, V_{GS}=-5\sim 20\text{V}$	
V_{TH}	Gate threshold voltage	1.8	2.8	4.5	V	$V_{GS}=V_{DS}, I_D=12\text{mA}$	Fig. 8, 9
			2.0			$V_{GS}=V_{DS}, I_D=12\text{mA}$ @ $T_J=175^\circ\text{C}$	
R_{ON}	Static drain-source on-resistance		30	39	$\text{m}\Omega$	$V_{GS}=18\text{V}, I_D=30\text{A}$ @ $T_J=25^\circ\text{C}$	Fig. 4, 5, 6, 7
			55		$\text{m}\Omega$	$V_{GS}=18\text{V}, I_D=30\text{A}$ @ $T_J=175^\circ\text{C}$	
			36	47	$\text{m}\Omega$	$V_{GS}=15\text{V}, I_D=30\text{A}$ @ $T_J=25^\circ\text{C}$	
			58		$\text{m}\Omega$	$V_{GS}=15\text{V}, I_D=30\text{A}$ @ $T_J=175^\circ\text{C}$	
C_{iss}	Input capacitance		3000		pF	$V_{DS}=800\text{V}, V_{GS}=0\text{V},$ $f=1\text{MHz}, V_{AC}=25\text{mV}$	Fig. 16
C_{oss}	Output capacitance		140		pF		
C_{rss}	Reverse transfer capacitance		7.7		pF		
E_{oss}	C_{oss} stored energy		57		μJ		Fig. 17
Q_g	Total gate charge		135		nC	$V_{DS}=800\text{V}, I_D=40\text{A},$ $V_{GS}=-3$ to 18V	Fig. 18
Q_{gs}	Gate-source charge		36.8		nC		
Q_{gd}	Gate-drain charge		45.3		nC		
R_g	Gate input resistance		2.3		Ω	$f=1\text{MHz}$	
E_{ON}	Turn-on switching energy		856.6		μJ	$V_{DS}=800\text{V}, I_D=40\text{A},$ $V_{GS}=-3.5$ to $18\text{V},$ $R_{G(ext)}=3.3\Omega,$ $L=200\mu\text{H}$ $T_J=25^\circ\text{C}$	Fig. 19, 20
E_{OFF}	Turn-off switching energy		118.0		μJ		
$t_{d(on)}$	Turn-on delay time		15.4		ns		
t_r	Rise time		24.6				
$t_{d(off)}$	Turn-off delay time		28.6				
t_f	Fall time		13.6				

Reverse Diode Characteristics ($T_c=25^\circ\text{C}$ unless otherwise specified)

Symbol	Parameter	Value			Unit	Test Conditions	Note
		Min.	Typ.	Max.			
V_{SD}	Diode forward voltage		4.2		V	$I_{SD}=30\text{A}, V_{GS}=0\text{V}$	Fig. 10, 11, 12
			4.0		V	$I_{SD}=30\text{A}, V_{GS}=0\text{V},$ $T_J=175^\circ\text{C}$	
t_{rr}	Reverse recovery time		54.8		ns	$V_{GS}=-3.5\text{V}/+18\text{V},$	
Q_{rr}	Reverse recovery charge		470.7		nC	$I_{SD}=40\text{A}, V_R=800\text{V},$	
I_{RRM}	Peak reverse recovery current		20.3		A	$R_{G(ext)}=13\Omega, L=200\mu\text{H}$ $di/dt=3000\text{A}/\mu\text{s}$	

Typical Performance (curves)

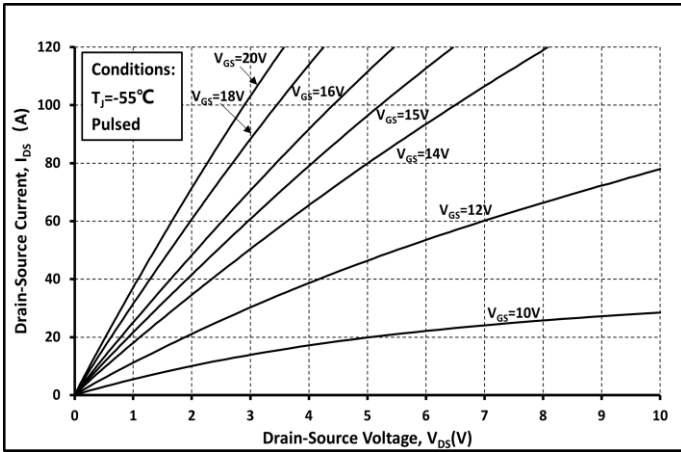

Fig. 1 Output Curve @ $T_j = -55^\circ\text{C}$

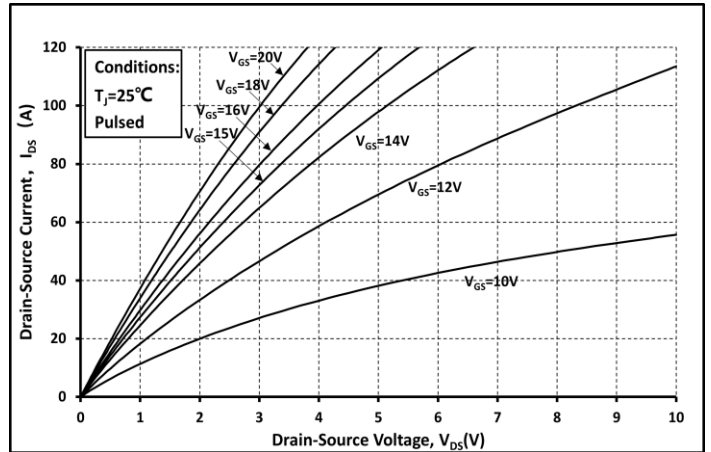

Fig. 2 Output Curve @ $T_j = 25^\circ\text{C}$

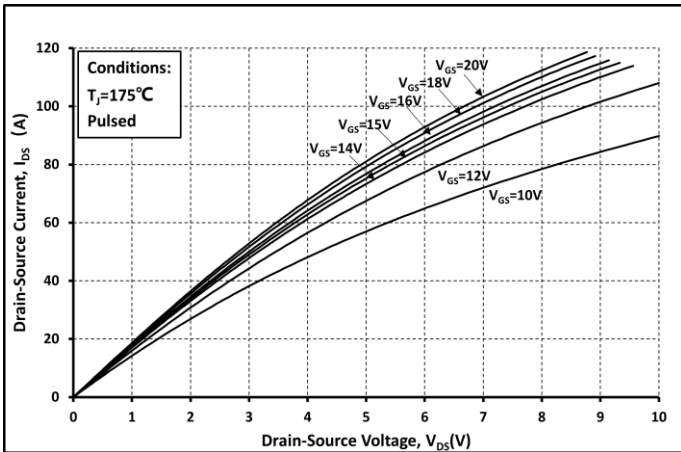

Fig. 3 Output Curve @ $T_j = 175^\circ\text{C}$

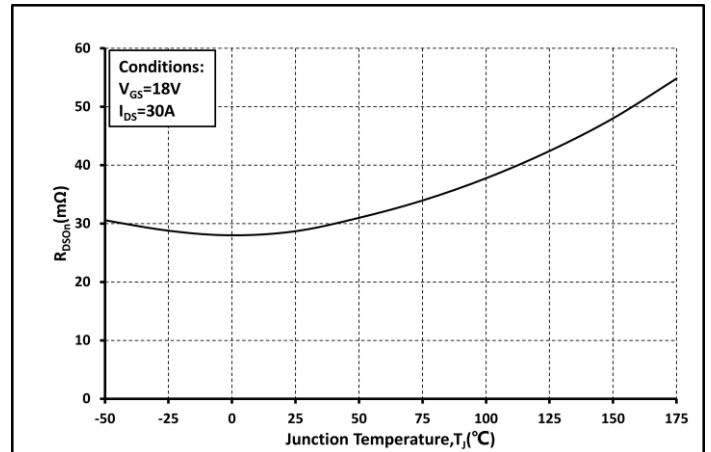

Fig. 4 R_{on} vs. Temperature

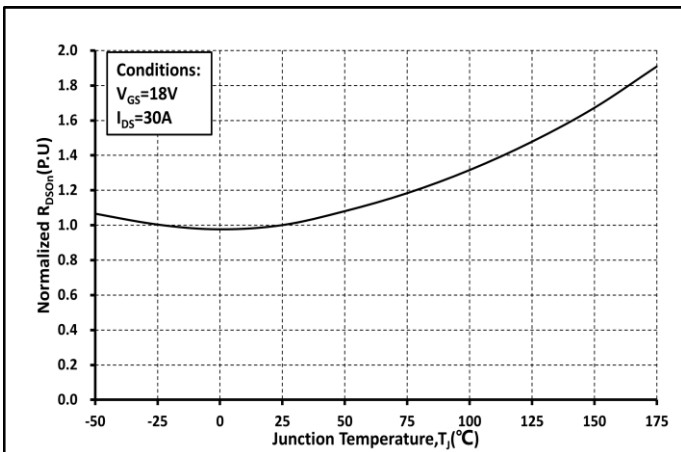

Fig. 5 Normalized R_{on} vs. Temperature

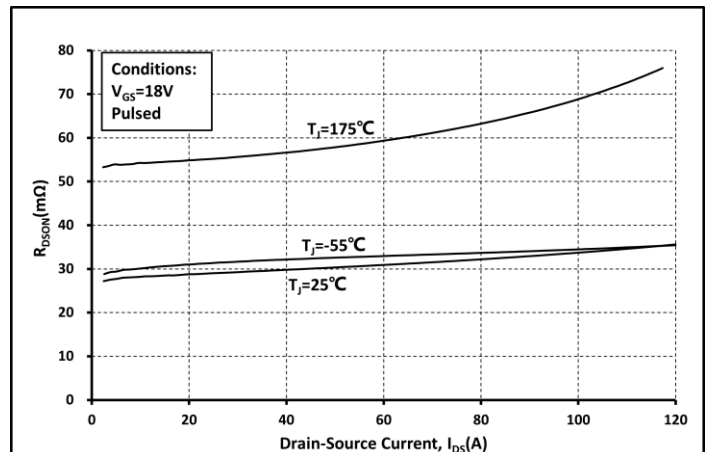

Fig. 6 R_{on} vs. I_{DS} @ Various Temperature

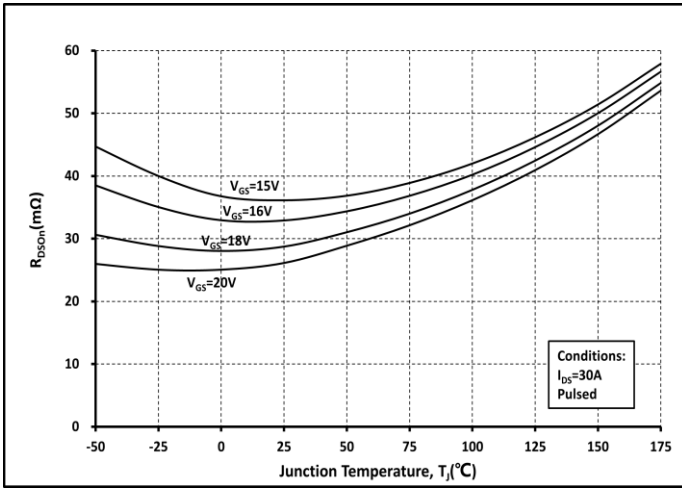

Fig. 7 Ron vs. Temperature @ Various V_{GS}

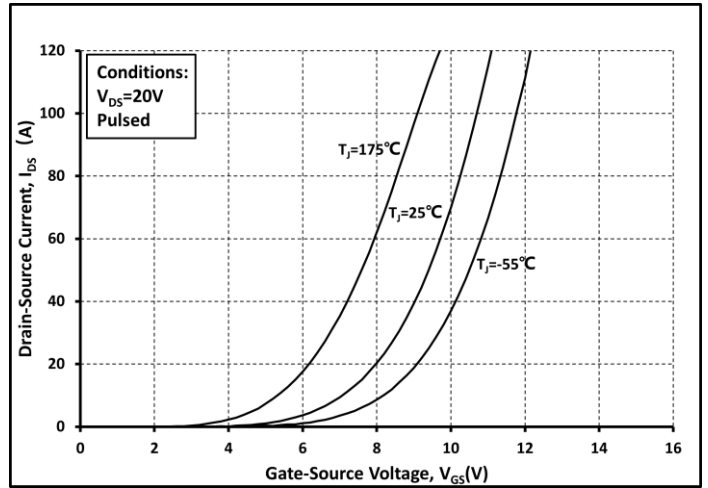

Fig. 8 Transfer Curves @ Various Temperature

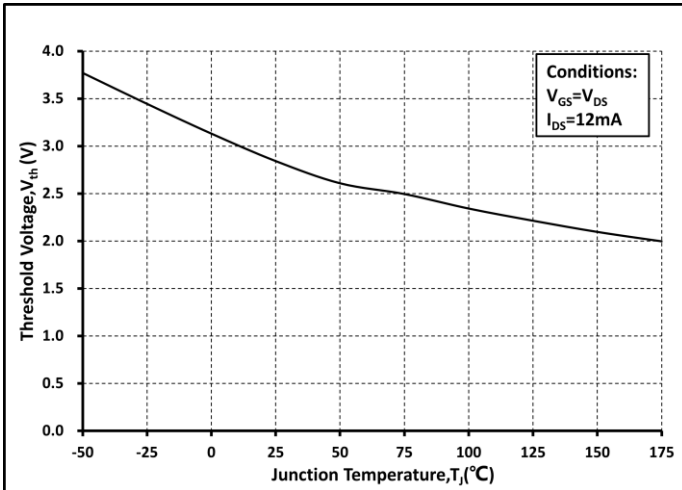

Fig. 9 Threshold Voltage vs. Temperature

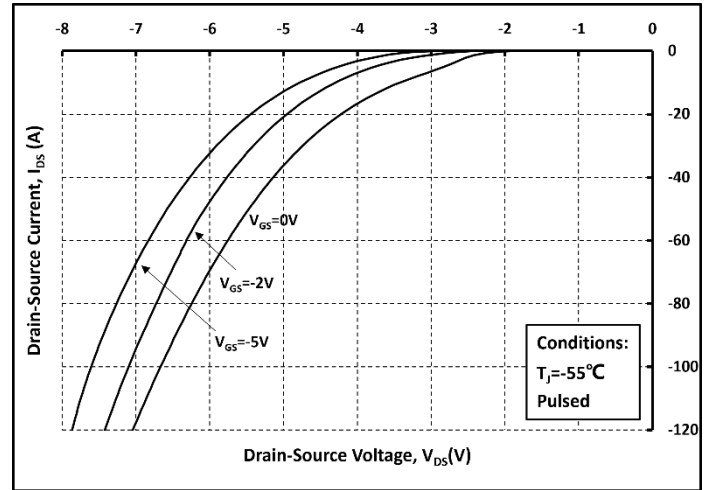

Fig. 10 Body Diode curves @ $T_J = -55^\circ\text{C}$

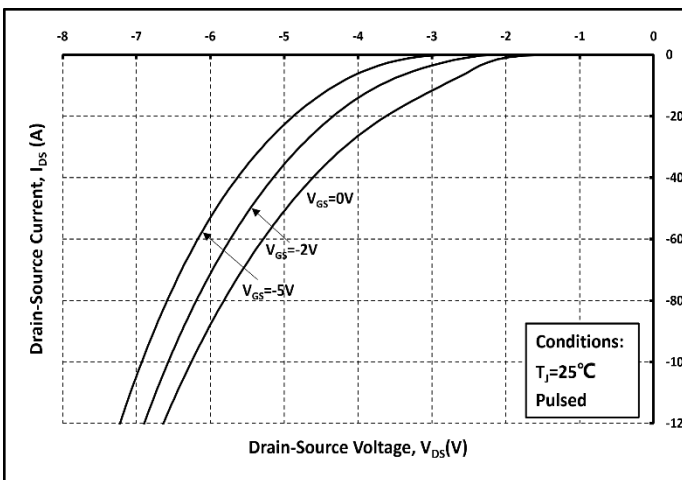

Fig. 11 Body Diode curves @ $T_J = 25^\circ\text{C}$

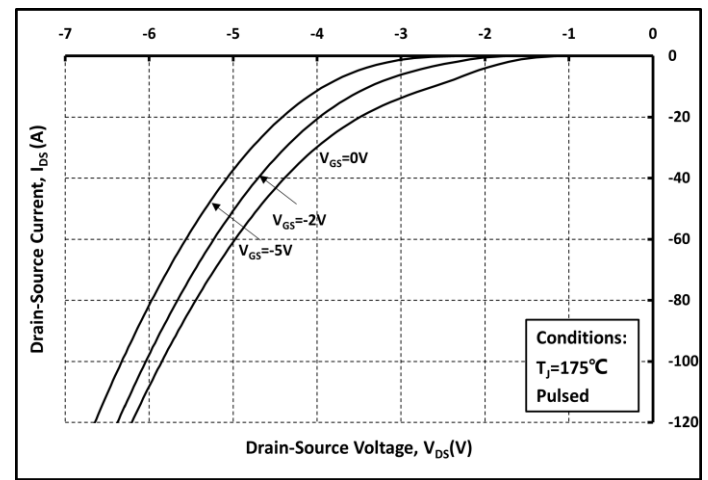

Fig. 12 Body Diode curves @ $T_J = 175^\circ\text{C}$

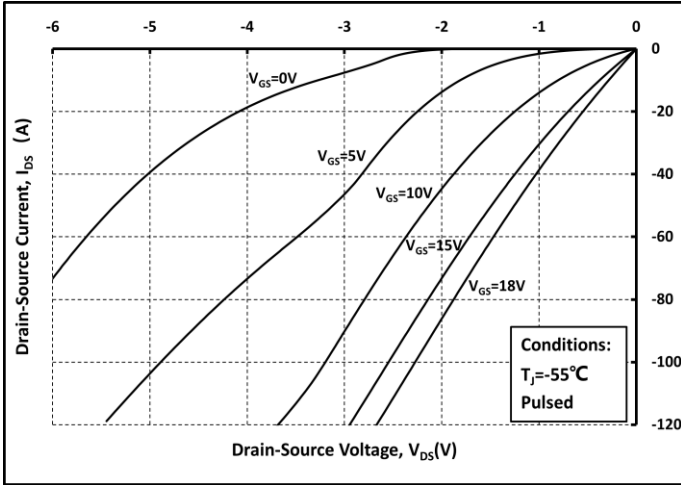

Fig. 13 3rd Quadrant curves @ T_J = -55°C

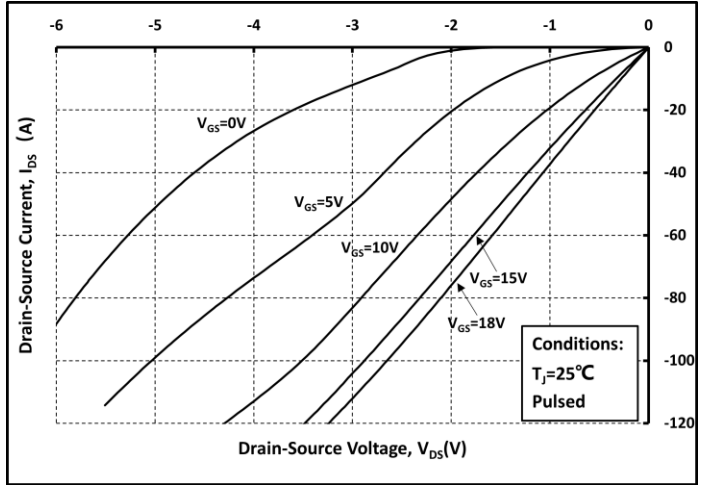

Fig. 14 3rd Quadrant curves @ T_J = 25°C

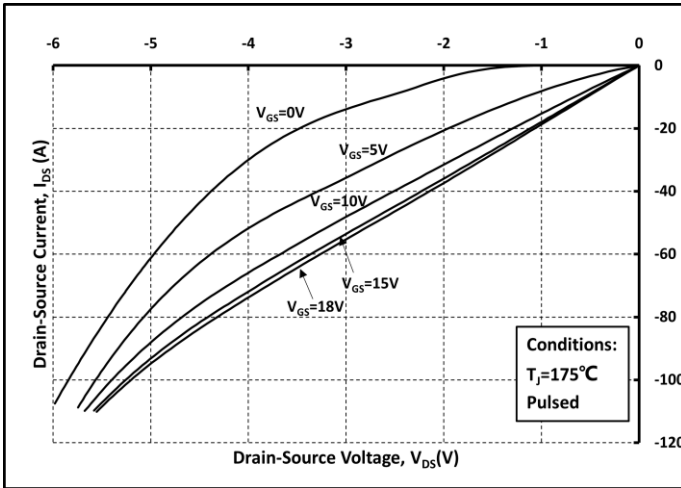

Fig. 15 3rd Quadrant curves @ T_J = 175°C

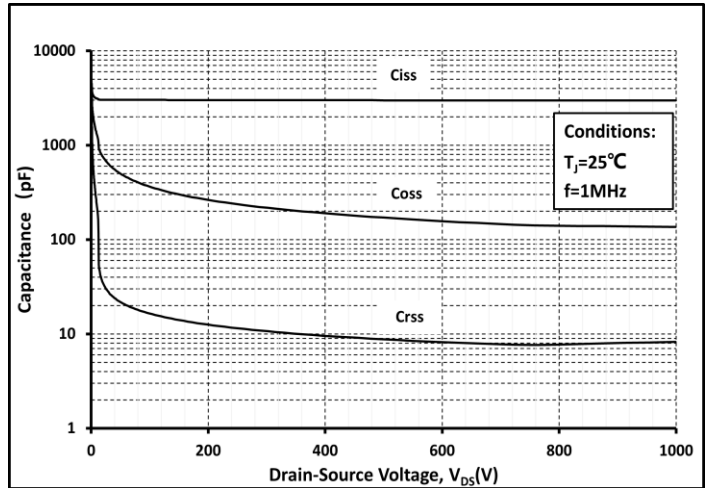

Fig. 16 Capacitance vs. V_{DS}

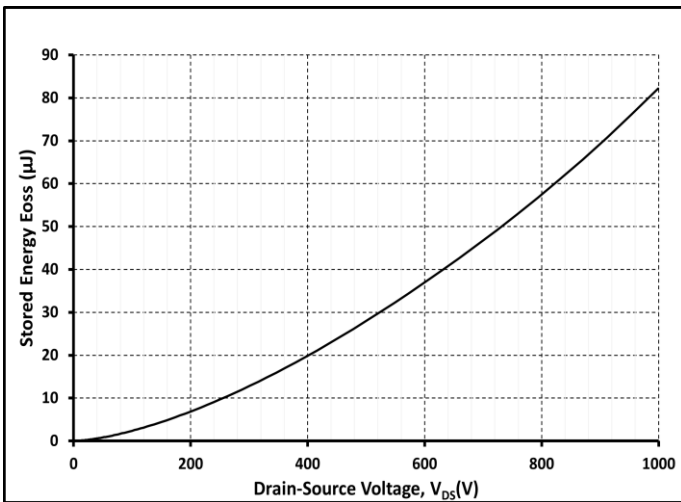

Fig. 17 Output Capacitor Stored Energy

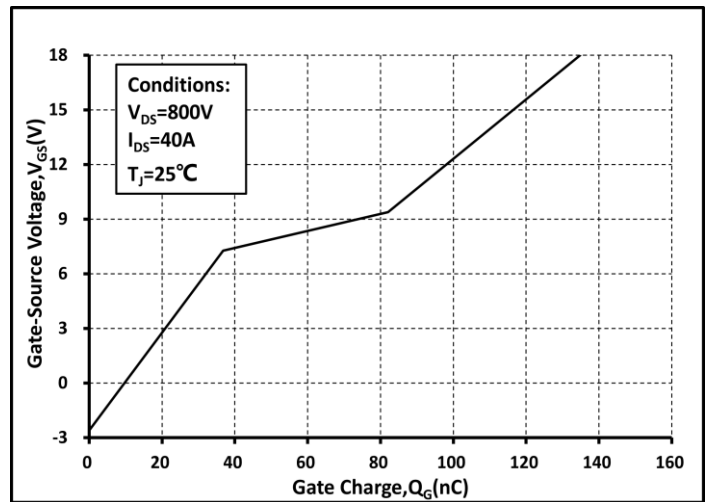

Fig. 18 Gate Charge Characteristics

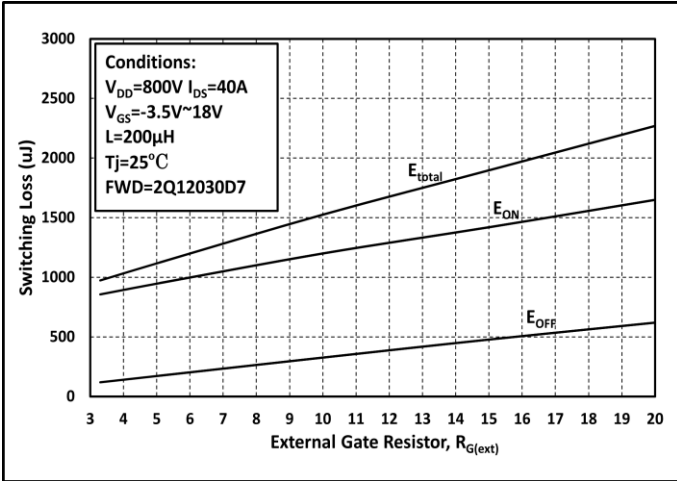

Fig. 19 Switching Energy vs. $R_{G(ext)}$

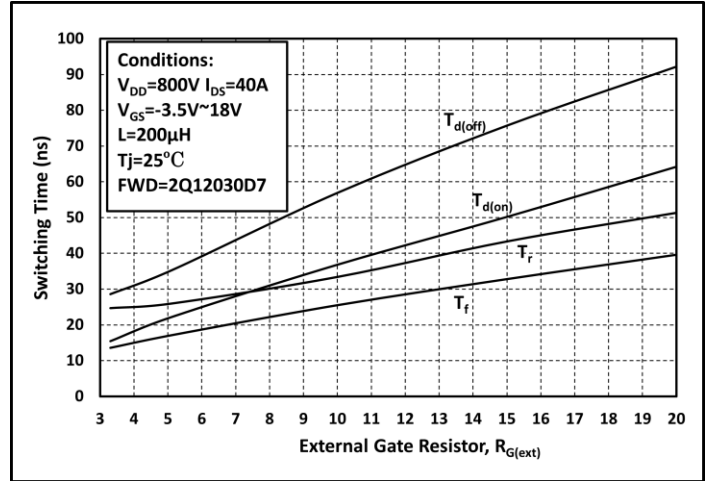

Fig. 20 Switching Times vs. $R_{G(ext)}$

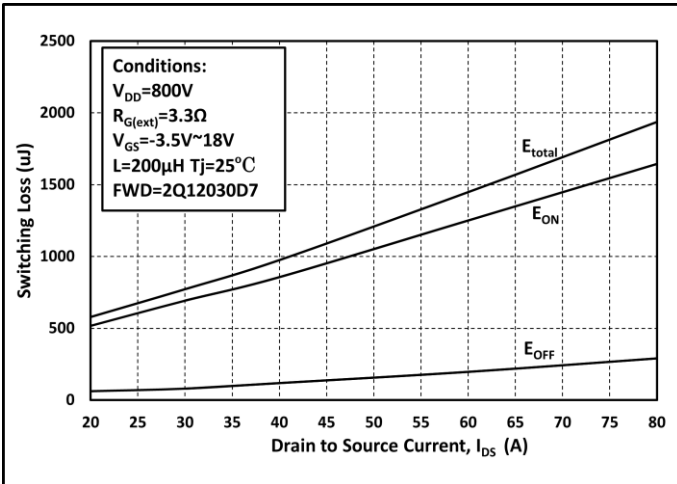

Fig. 21 Switching Energy vs. I_{DS}

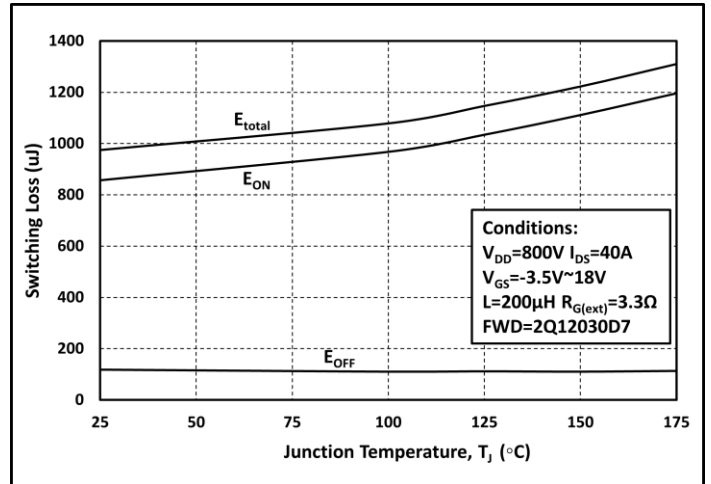

Fig. 22 Switching Energy vs. Temperature

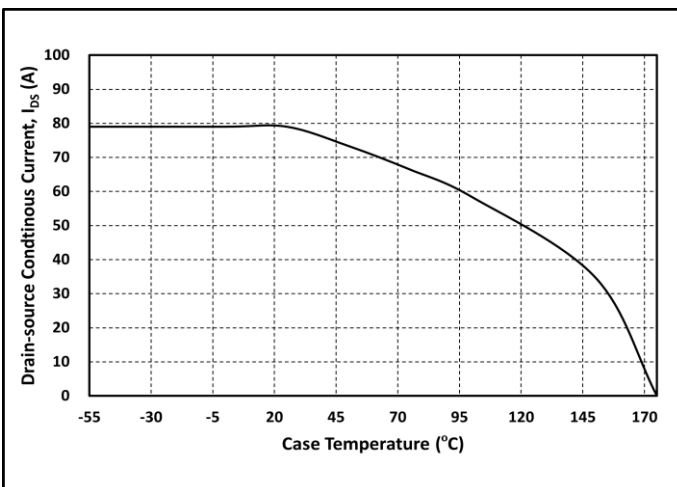

Fig. 23 Continuous Drain Current vs. Case Temperature

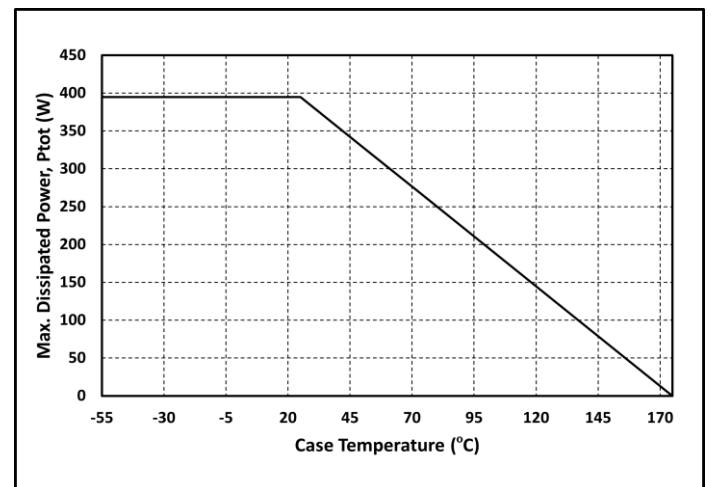

Fig. 24 Max. Power Dissipation Derating vs. Case Temperature

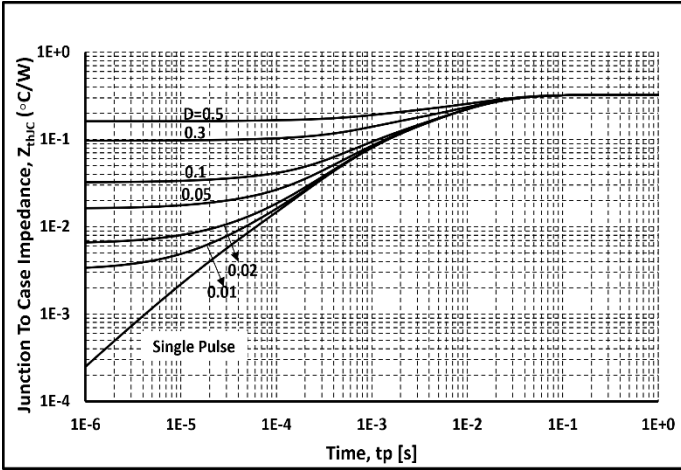

Fig. 25 Thermal impedance

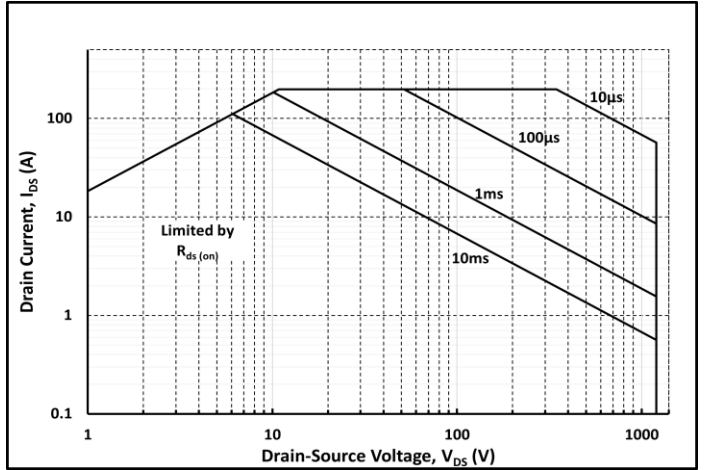
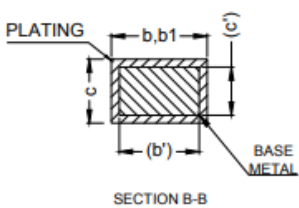
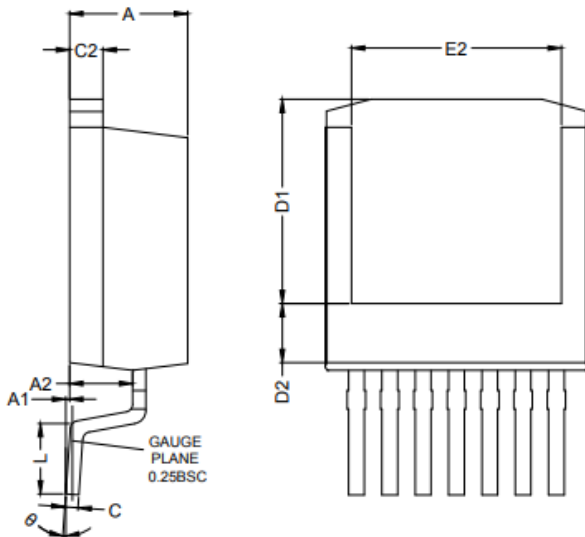
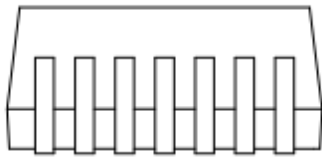
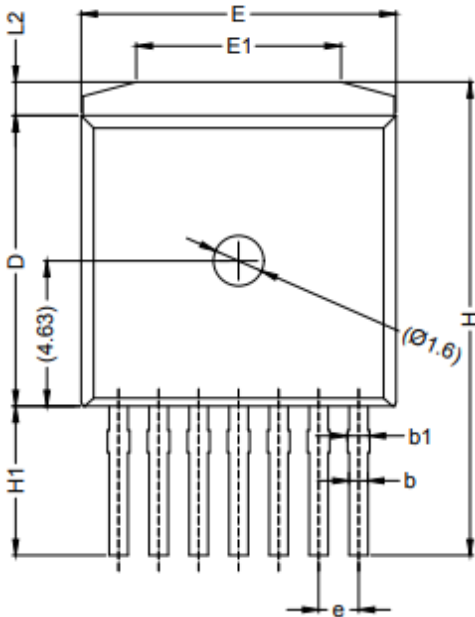

Fig. 26 Safe Operating Area

Package Dimensions



Items	Min	Max
A	4.30	4.70
A1	-	0.25
A2	2.20	2.60
b	0.52	0.72
b'	0.50	0.70
b1	0.60	0.80
c	0.42	0.62
c'	0.40	0.60
c2	1.07	1.47
D	9.05	9.45
D1	7.58	7.98
D2	2.05	2.45
e	1.27 BSC	
E	9.80	10.20
E1	6.30	6.70
E2	7.80	8.20
L	2.48	2.88
L2	0.87	1.27
H	14.87	15.27
H1	4.55	4.95
θ	0°	8°

Note:

1. Package Reference: JEDEC TO263, Variation AD
2. All Dimensions are in mm
3. Subject to Change Without Notice

Notes

For further information please contact IVCT's office.

Copyright©2023 InventChip Technology Co., Ltd. All rights reserved.

The Information in this document is subject to change without notice.

Related Links

<http://www.inventchip.com.cn>



X-ON Electronics

Largest Supplier of Electrical and Electronic Components

Click to view similar products for [MOSFET](#) category:

Click to view products by [InventChip](#) manufacturer:

Other Similar products are found below :

[IRFD120](#) [IRFY240C](#) [JANTX2N5237](#) [2SK2267\(Q\)](#) [BUK455-60A/B](#) [MIC4420CM-TR](#) [VN1206L](#) [NDP4060](#) [SI4482DY](#)
[IPS70R2K0CEAKMA1](#) [SQD23N06-31L-GE3](#) [TK16J60W,S1VQ\(O](#) [2SK2614\(TE16L1,Q\)](#) [DMN1017UCP3-7](#) [EFC2J004NUZTDG](#)
[DMN1053UCP4-7](#) [SQJ469EP-T1-GE3](#) [NTE2384](#) [DMC2700UDMQ-7](#) [DMN2080UCB4-7](#) [DMN61D9UWQ-13](#) [US6M2GTR](#)
[DMN31D5UDJ-7](#) [DMP22D4UFO-7B](#) [DMN1006UCA6-7](#) [DMN16M9UCA6-7](#) [STF5N65M6](#) [IRF40H233XTMA1](#) [STU5N65M6](#)
[DMN6022SSD-13](#) [DMN13M9UCA6-7](#) [DMTH10H4M6SPS-13](#) [DMN2990UFB-7B](#) [IPB80P04P405ATMA2](#) [2N7002W-G](#) [MCAC30N06Y-](#)
[TP](#) [MCQ7328-TP](#) [NTMC083NP10M5L](#) [NVMFS2D3P04M8LT1G](#) [BXP7N65D](#) [BXP4N65F](#) [AOL1454G](#) [WMJ80N60C4](#) [BXP2N20L](#)
[BXP2N65D](#) [BXT1150N10J](#) [BXT1700P06M](#) [TSM60NB380CP](#) [ROG](#) [RQ7L055BGTCR](#) [DMNH15H110SK3-13](#)