

IV1Q12050MA1L – 1200V 50mΩ MOSFET + 20A SBD SiC MODULE

Features:

- High speed switching SiC MOSFET
- High operating junction temperature capability
- Kelvin gate input easing driver circuit design
- Freewheeling diode with zero reverse recovery

Applications:

- Photo voltaic inverters
- Multi-level converter
- High voltage AC/DC converters

Package:

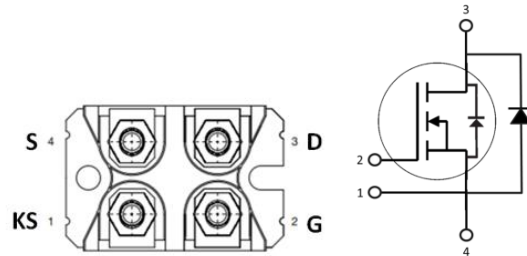

Part Number	Package
IVST12050MA1L	sot227

Absolute Maximum Ratings (T_c=25°C unless otherwise specified)

Symbol	Parameter	Value	Unit	Test Conditions	Note
SiC MOSFET					
V _{DS}	Drain-Source voltage	1200	V	V _{GS} =0V, I _b =100μA	
V _{GSmax} (DC)	Maximum DC voltage	-5 to 22	V	Static (DC)	
V _{GSmax} (Spike)	Maximum spike voltage	-10 to 25	V	<1% duty cycle, and pulse width<200ns	
V _{GSon}	Recommended turn-on voltage	20±0.5	V		
V _{GSoff}	Recommended turn-off voltage	-3.5 to -2	V		
I _D	Drain current (continuous)	64	A	V _{GS} =20V, T _c =25°C	Fig. 21
		45	A	V _{GS} =20V, T _c =100°C	
I _{DM}	Drain current (pulsed)	160	A	Pulse width limited by SOA	Fig. 24
P _{TOT}	Total power dissipation	413	W	T _c =25°C	Fig. 22
T _{stg}	Storage temperature range	-55 to 175	°C		
T _J	Operating junction temperature	-55 to 175	°C		
SiC SBD					
V _{RRM}	Reverse voltage (repetitive peak)	1200	V		
V _{DC}	DC blocking voltage	1200	V		
I _F	Forward current (continuous)	49.1	A	T _c =25°C	
		20	A	T _c =144°C	
I _{FSM}	Surge non-repetitive forward current	155	A	sine halfwave @T _c =25°C tp=10ms	

I_{FRM}	Surge repetitive forward current (Freq=0.1Hz, 100cycles)	125	A	sine halfwave @ $T_{amb}=25^{\circ}C$ $t_p=10m$	
$\int i^2 dt$	I^2t value	120	A^2s	$T_c=25^{\circ}C$ $t_p=10ms$	

Thermal Data

Symbol	Parameter	Value	Unit	Note
$R_{\theta(j-c)}$	Thermal Resistance from Junction to Case	0.363*	$^{\circ}C/W$	Per MOSFET Fig. 23
$R_{\theta(j-c)}$	Thermal Resistance from Junction to Case	0.700*	$^{\circ}C/W$	Per SBD

* By simulation

Electrical Characteristics ($T_c=25^{\circ}C$ unless otherwise specified)

Symbol	Parameter	Value			Unit	Test Conditions	Note
		Min.	Typ.	Max.			
I_{DSS}	Zero gate voltage drain current		5	100	μA	$V_{DS}=1200V, V_{GS}=0V$	
I_{GSS}	Gate leakage current			± 100	nA	$V_{DS}=0V, V_{GS}=-5\sim 20V$	
V_{TH}	Gate threshold voltage	1.8	3.2	5	V	$V_{GS}=V_{DS}, I_D=6mA$	Fig. 8, 9
			2.2			$V_{GS}=V_{DS}, I_D=6mA$ @ $T_c=175^{\circ}C$	
R_{ON}	Static drain-source on-resistance		50	65	$m\Omega$	$V_{GS}=20V, I_D=20A$ @ $T_j=25^{\circ}C$	Fig. 4, 5, 6, 7
			80		$m\Omega$	$V_{GS}=20V, I_D=20A$ @ $T_j=175^{\circ}C$	
C_{iss}	Input capacitance		2700		pF	$V_{DS}=800V, V_{GS}=0V,$ $f=100kHz, V_{AC}=25mV$	Fig. 16
C_{oss}	Output capacitance		217		pF		
C_{rss}	Reverse transfer capacitance		16.6		pF		
E_{oss}	C_{oss} stored energy		81		μJ		Fig. 17
Q_g	Total gate charge		120		nC	$V_{DS}=800V, I_D=20A,$ $V_{GS}=-5$ to $20V$	Fig. 18
Q_{gs}	Gate-source charge		25		nC		
Q_{gd}	Gate-drain charge		48		nC		
R_g	Gate input resistance		2.8		Ω	$f=1MHz$	
E_{ON}	Turn-on switching energy		434.7		μJ	$V_{DS}=800V$ $I_{DS}=30A,$ $V_{GS}=-3.5V\sim 20V,$ $R_{G(ext)}=3.3\Omega,$ $L=200\mu H$	Fig. 19, 20
E_{OFF}	Turn-off switching energy		115.5		μJ		
$t_{d(on)}$	Turn-on delay time		12		ns		
t_r	Rise time		23.6				
$t_{d(off)}$	Turn-off delay time		25.2				
t_f	Fall time		18				
SiC SBD							

V _F	Forward Voltage		1.48	1.80	V	I _F = 20 A T _J =25°C	Fig. 25
			2.20	3.00		I _F = 20 A T _J =175°C	
I _R	Reverse Current		8	150	μA	V _R = 1200 V T _J =25°C	Fig. 26
			50	800		V _R = 1200 V T _J =175°C	
C	Total Capacitance		1180		pF	V _R = 1 V, T _J = 25°C, f = 1 MHz	Fig. 27
			144			V _R = 400 V, T _J = 25°C, f = 1 MHz	
			117			V _R = 800 V, T _J = 25°C, f = 1 MHz	
Q _C	Total Capacitive Charge		142		nC	V _R = 800 V, T _J = 25°C, $Q_c = \int_0^{V_R} C(V)dV$	Fig. 28
E _C	Capacitance Stored Energy		44		μJ	V _R = 800 V, T _J = 25°C, $E_c = \int_0^{V_R} C(V) \cdot VdV$	Fig. 29

Body Diode Characteristics ($T_c=25^\circ\text{C}$ unless otherwise specified)

Symbol	Parameter	Value			Unit	Test Conditions	Note
		Min.	Typ.	Max.			
V_{SD}	Diode forward voltage		4.9		V	$I_{SD}=20\text{A}, V_{GS}=0\text{V}$	Fig. 10, 11, 12
			4.4		V	$I_{SD}=20\text{A}, V_{GS}=0\text{V}, T_J=175^\circ\text{C}$	
t_{rr}	Reverse recovery time		54.6		ns	$V_{GS}=-3.5\text{V}/+20\text{V}, I_{SD}=30\text{A}, V_R=800\text{V}, di/dt=2000\text{A}/\mu\text{s}, R_{G(\text{ext})}=16\Omega, L=270\mu\text{H}$	
Q_{rr}	Reverse recovery charge		233		nC		
I_{RRM}	Peak reverse recovery current		17.2		A		

Module Characteristics

Symbol	Parameter	Conditions	Value			Unit
			Min.	Typ.	Max.	
V_{ISOL}	Isolation test voltage	RMS, $f=50\text{Hz}, t=1\text{min}$			2.5	kV
M	Terminal connection torque	Screw M4	1.1		1.5	N·m
	Mounting torque	Screw M4	1.1		1.5	N·m
G	Weight of module			27		g
	Creepage distance	Terminal to heatsink		10.61		mm
		Terminal to terminal		10.37		mm
	Clearance	Terminal to heatsink		6.7		mm
		Terminal to terminal		4.05		mm

SiC MOSFET Typical Characteristics

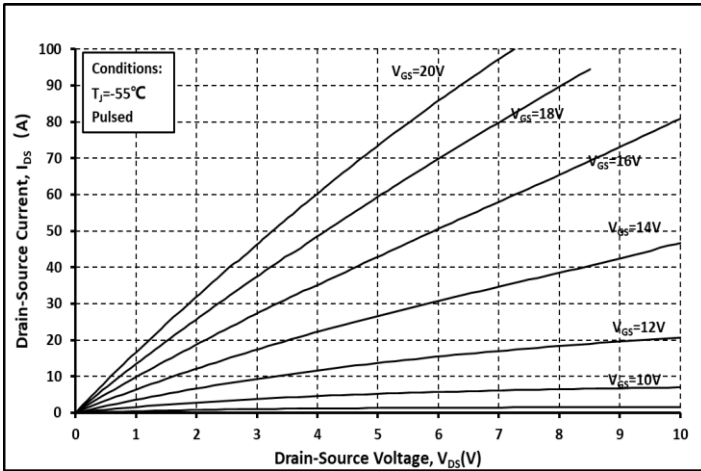

Fig. 1 Output Curve @ $T_j = -55^\circ\text{C}$

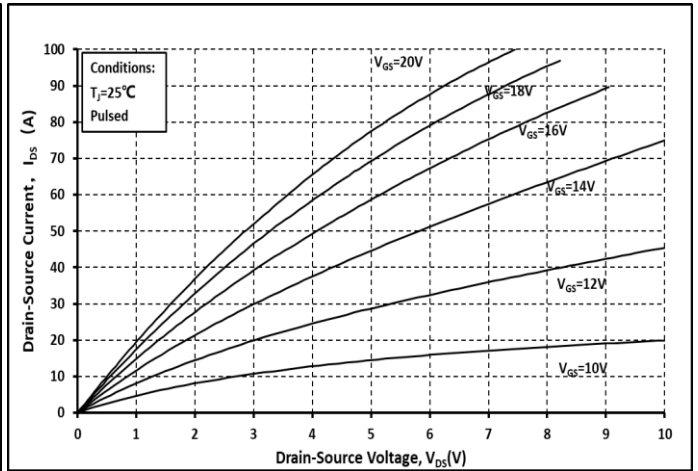

Fig. 2 Output Curve @ $T_j = 25^\circ\text{C}$

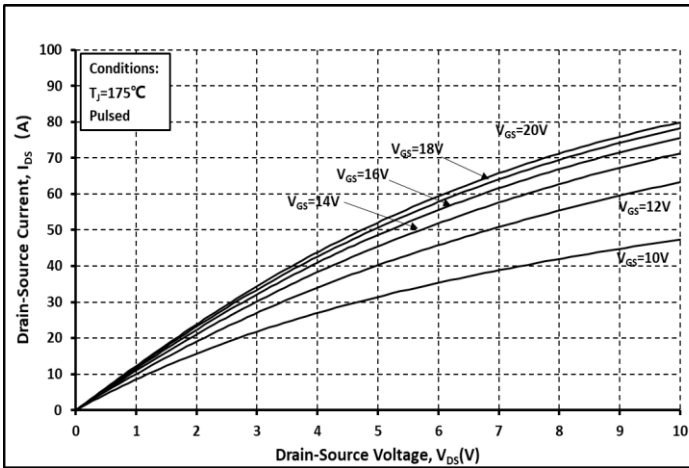

Fig. 3 Output Curve @ $T_j = 175^\circ\text{C}$

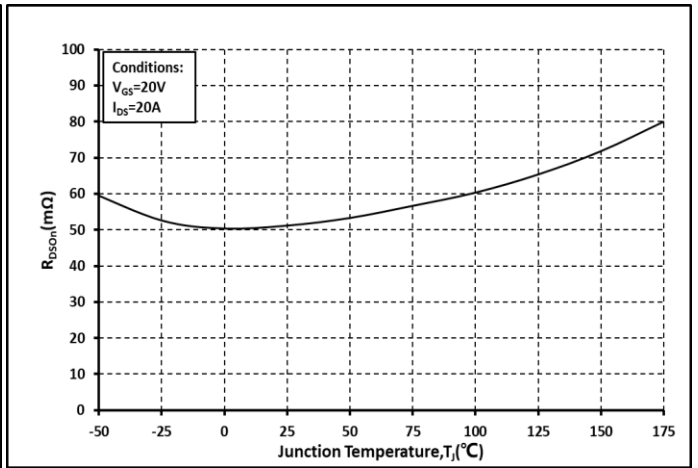

Fig. 4 R_{on} vs. Temperature

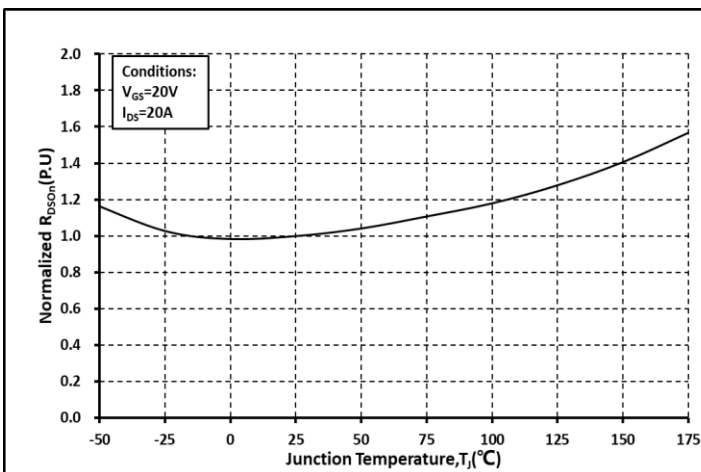

Fig. 5 Normalized R_{on} vs. Temperature

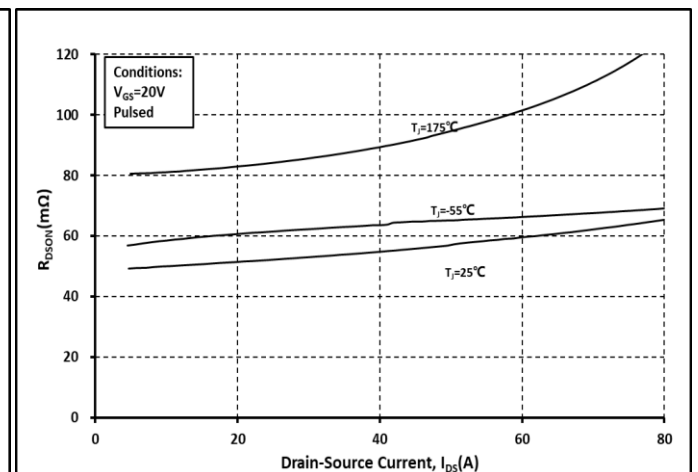

Fig. 6 R_{on} vs. I_{DS} @ Various Temperature

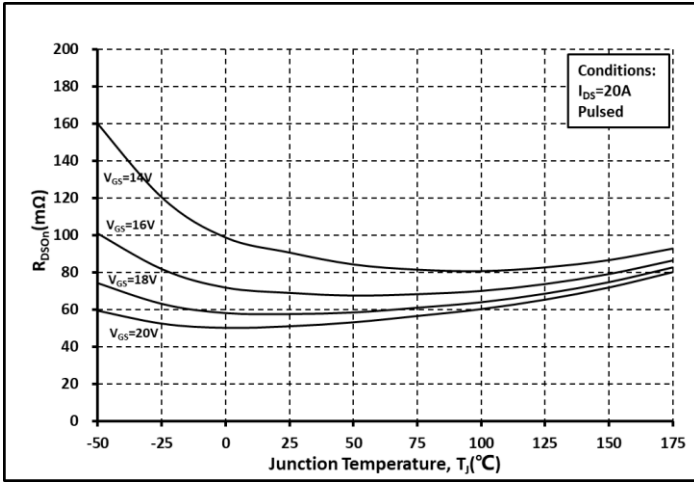

Fig. 7 Ron vs. Temperature @ Various V_{GS}

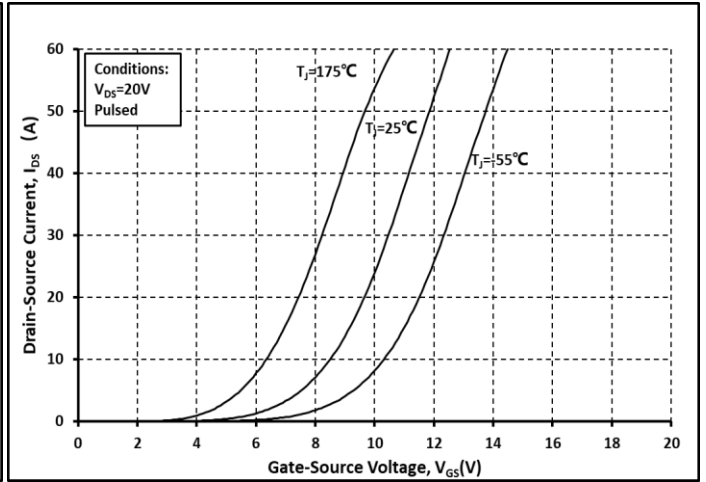

Fig. 8 Transfer Curves @ Various Temperature

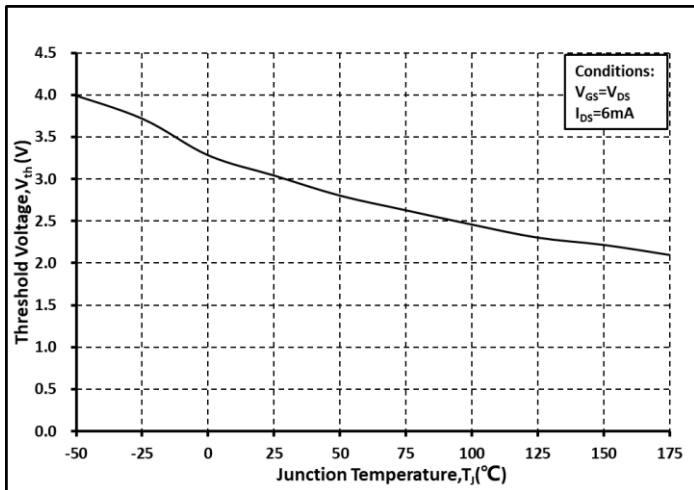

Fig. 9 Threshold Voltage vs. Temperature

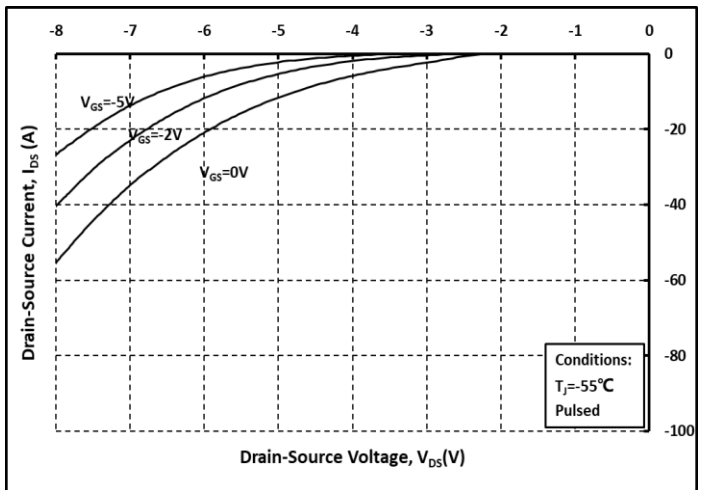

Fig. 10 Body Diode Curves @ $T_j = -55^\circ\text{C}$

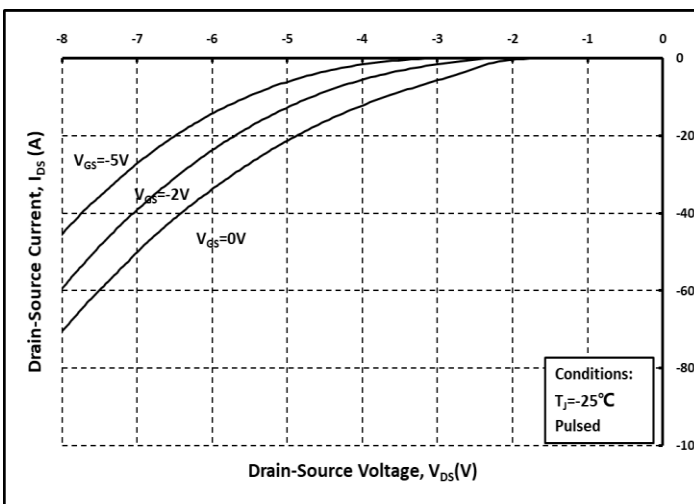

Fig. 11 Body Diode Curves @ $T_j = 25^\circ\text{C}$

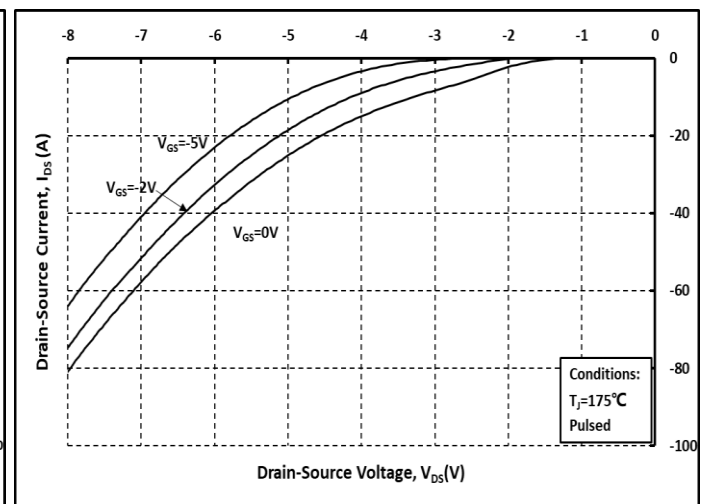

Fig. 12 Body Diode Curves @ $T_j = 175^\circ\text{C}$

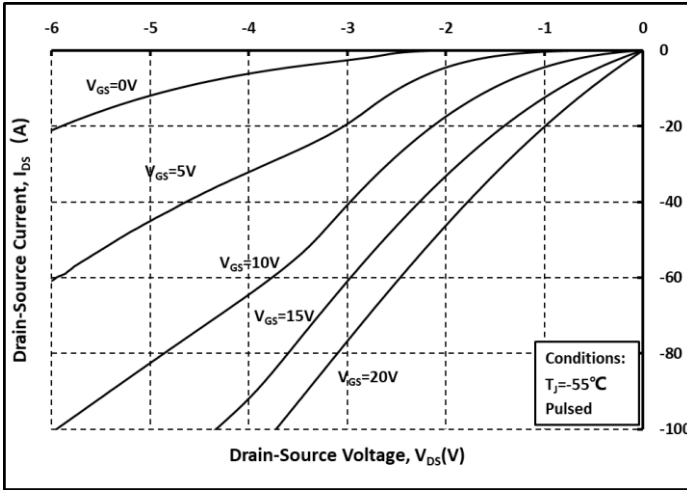

Fig. 13 3rd Quadrant Curves @ $T_j = -55^\circ\text{C}$

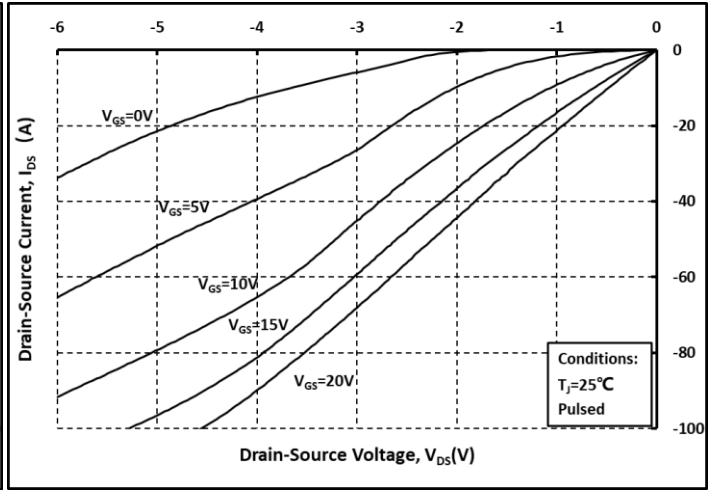

Fig. 14 3rd Quadrant Curves @ $T_j = 25^\circ\text{C}$

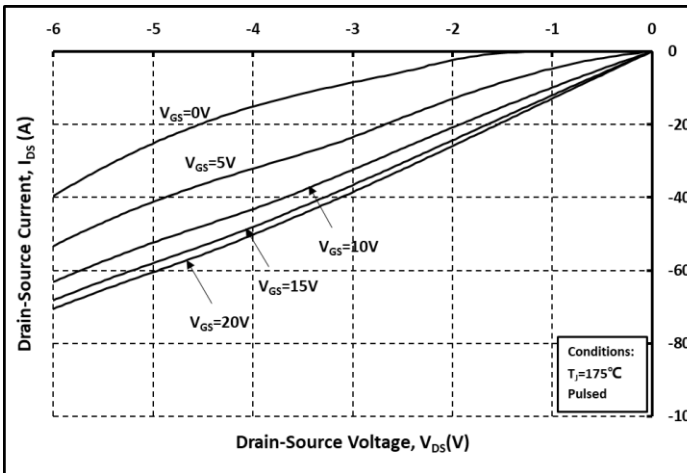

Fig. 15 3rd Quadrant Curves @ $T_j = 175^\circ\text{C}$

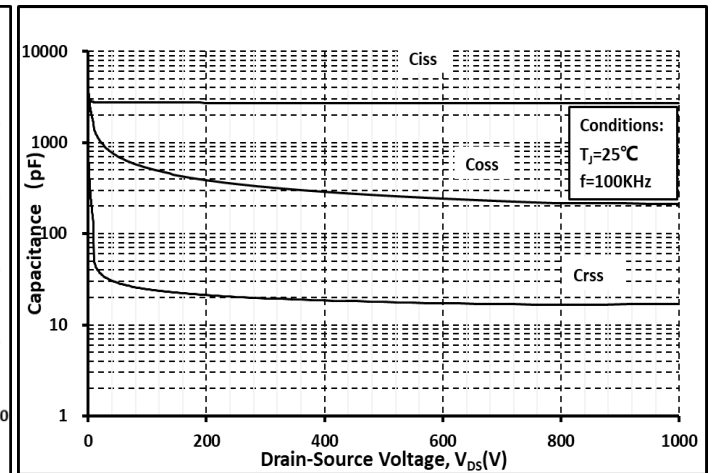

Fig. 16 Capacitance vs. V_{DS}

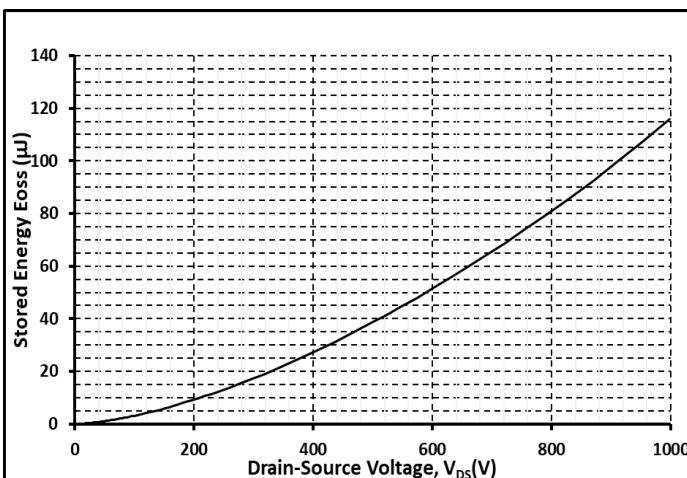

Fig. 17 Output Capacitor Stored Energy

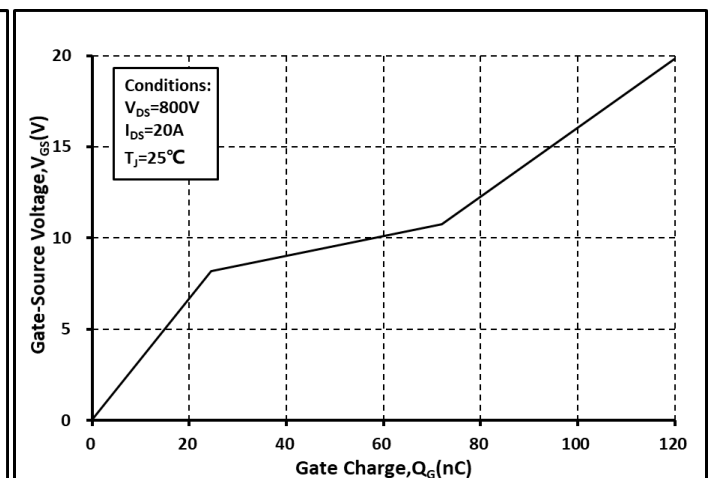

Fig. 18 Gate Charge Characteristics

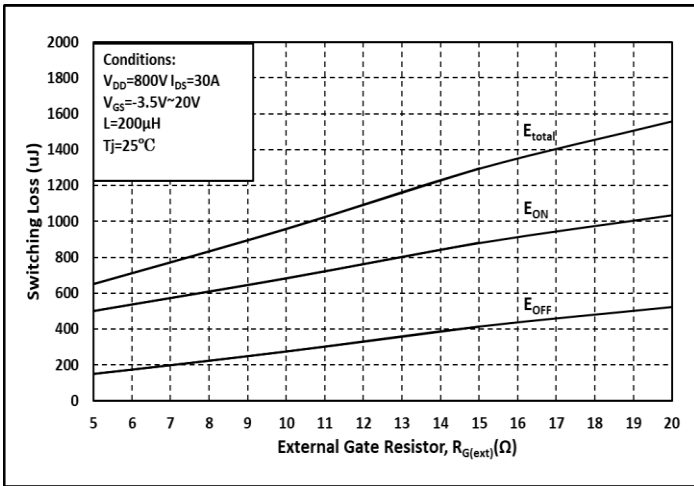

Fig. 19 Switching Energy vs. $R_{G(ext)}$

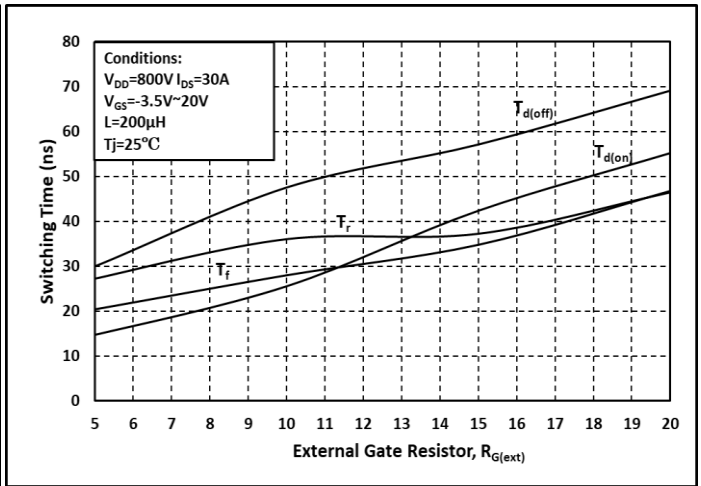

Fig. 20 Switching Times vs. $R_{G(ext)}$

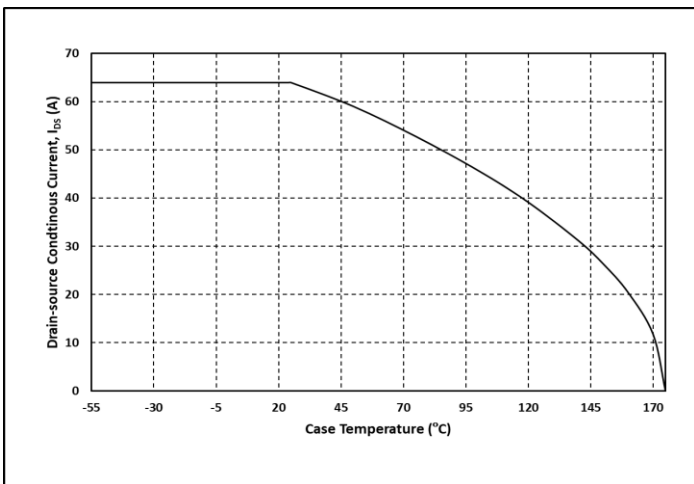

Fig. 21 Continuous Drain Current vs. Case Temperature

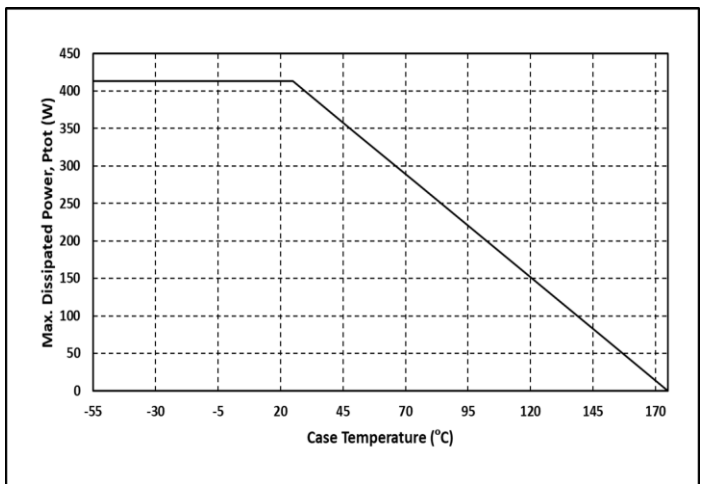

Fig. 22 Max. Power Dissipation Derating vs. Case Temperature

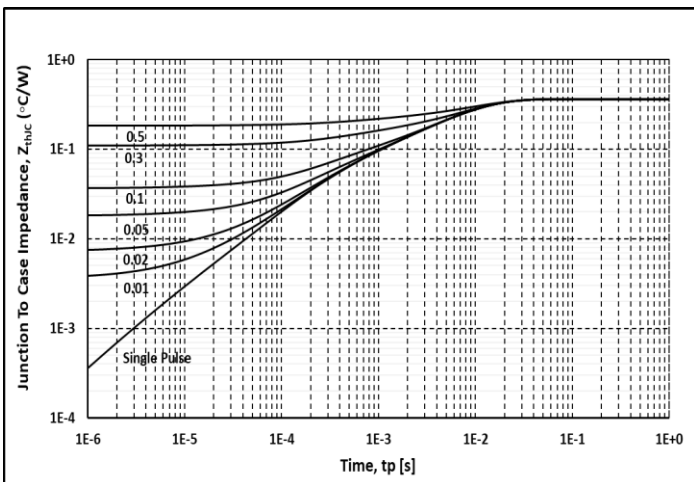

Fig. 23 Thermal Impedance

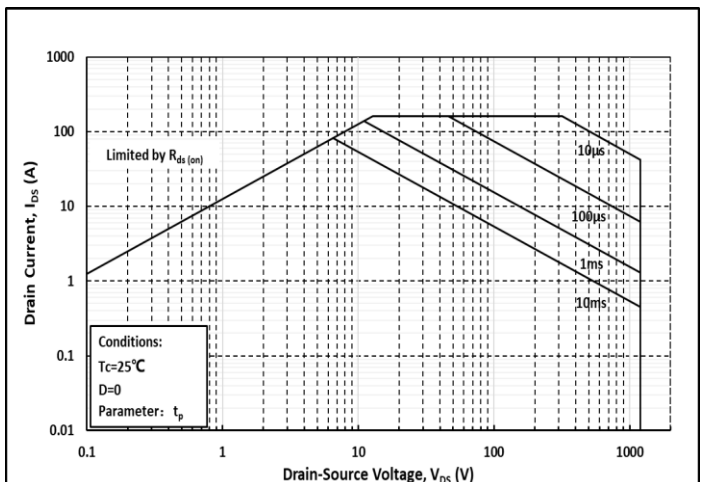

Fig. 24 Safe Operating Area

SiC SBD Typical Characteristics

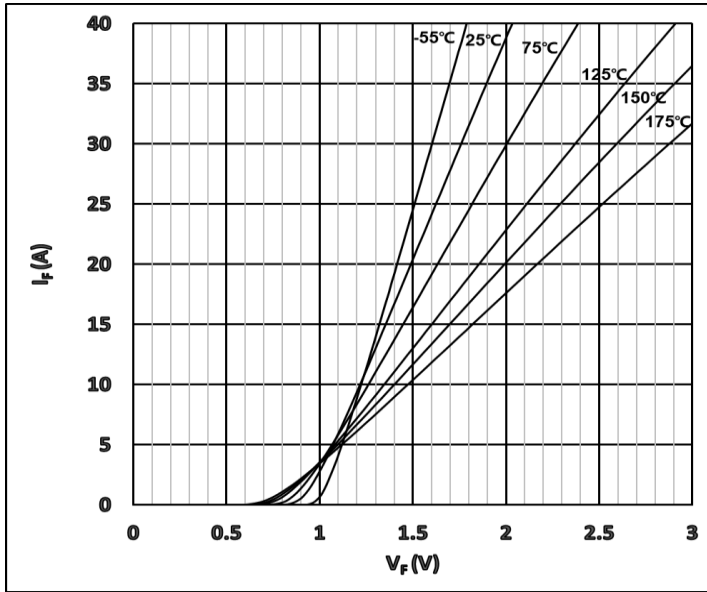

Figure 25. Typical Forward Characteristics

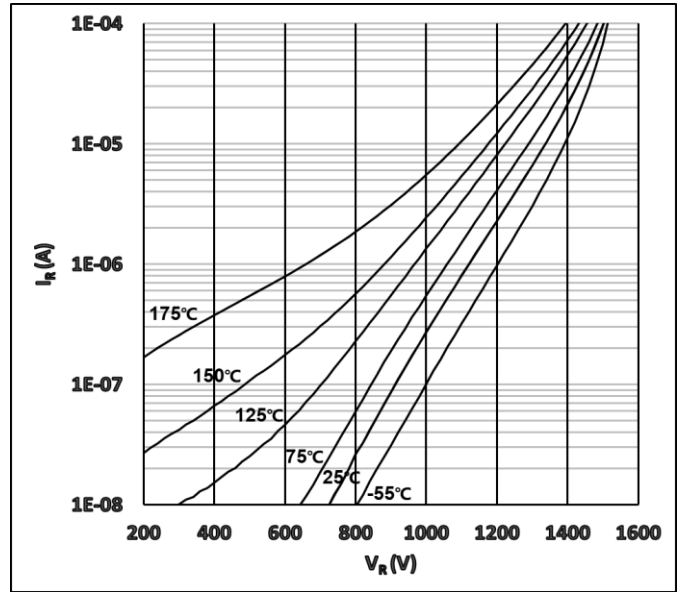

Figure 26. Typical Reverse Characteristics

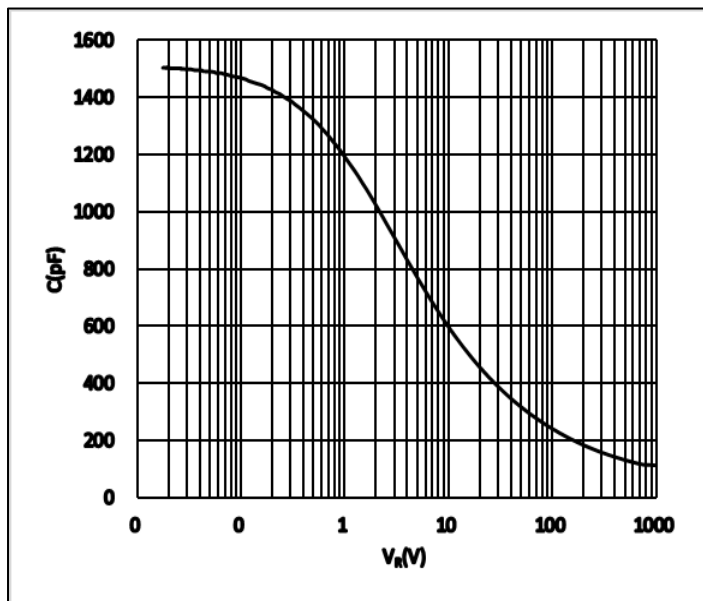

Figure 27. Capacitance vs. Reverse Voltage

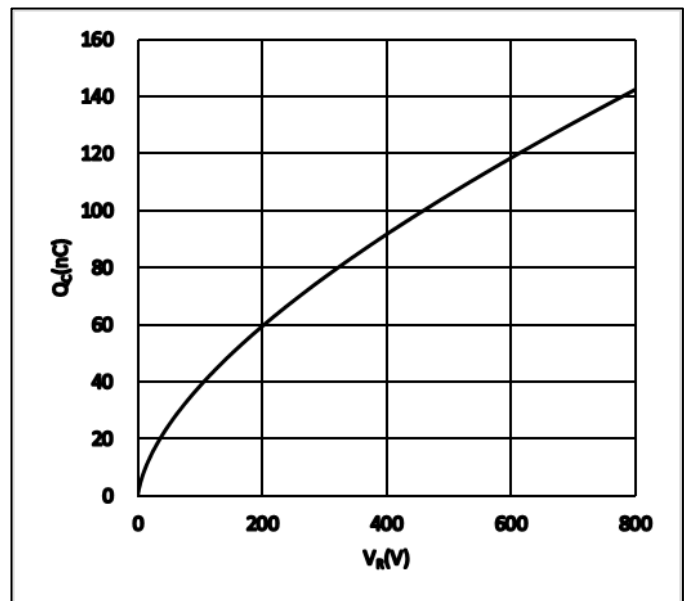

Figure 28. Recovery Charge vs. Reverse Voltage

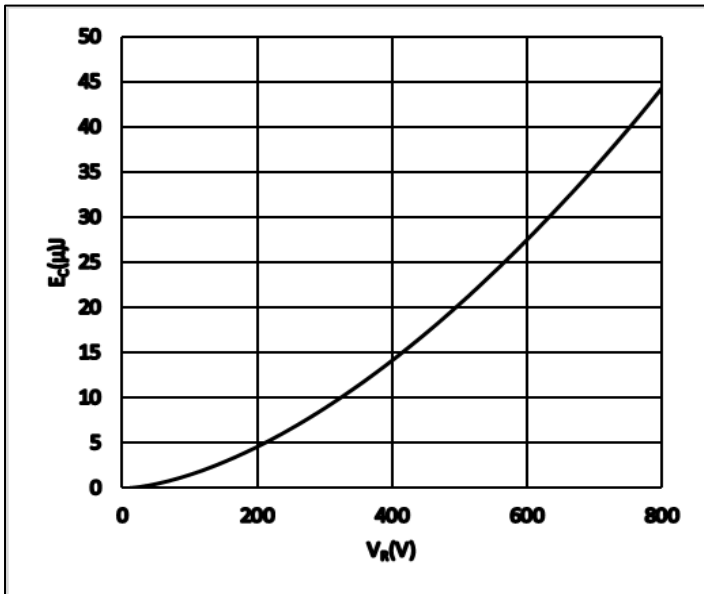

Figure 29. Capacitance Stored Energy

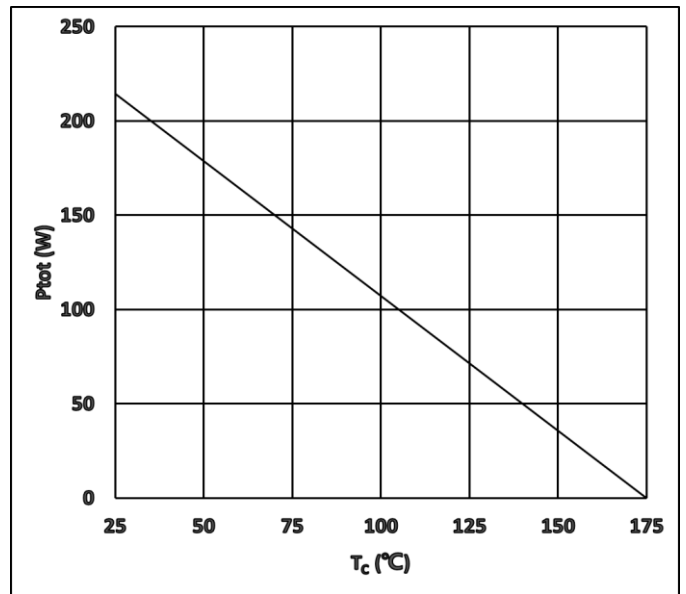
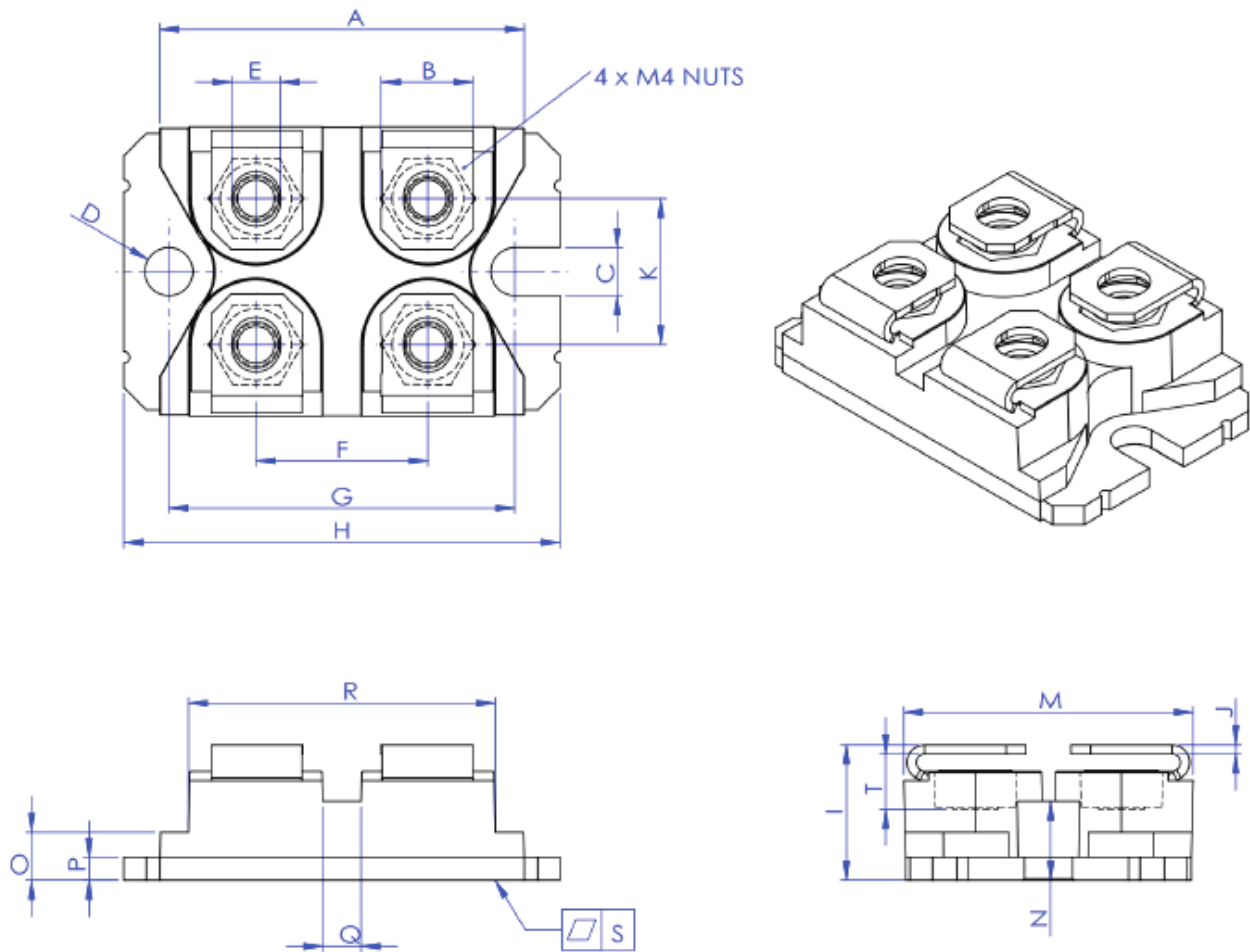

Figure 30. Power Derating

Package Dimensions



Dimension	Millimeter		Typical
	Min	Max	
A	31.50	32.00	31.70
B	7.70	8.30	8.00
C	4.10	4.30	4.20
D	4.10	4.30	4.20
E	4.10	4.30	4.20
F	14.90	15.15	15.0
G	29.80	30.40	30.10
H	37.80	38.30	38.05
I	11.80	12.30	12.05
J	0.75	0.85	0.80
K	12.50	13.00	12.75
M	25.00	25.50	25.30
N	6.75	7.10	6.90
O	4.00	4.40	4.20
P	1.90	2.10	2.00
Q	3.20	3.60	3.40
R	26.60	27.00	26.80
S	-0.03	0.10	0.01
T	4.85	5.25	5.05

Notes

For further information please contact IVCT's Office.

Copyright©2022 InventChip Technology Co., Ltd. All rights reserved.

The Information in this document is subject to change without notice.

Related Links

<http://www.inventchip.com.cn>



X-ON Electronics

Largest Supplier of Electrical and Electronic Components

Click to view similar products for [MOSFET](#) category:

Click to view products by [InventChip](#) manufacturer:

Other Similar products are found below :

[IRFD120](#) [IRFY240C](#) [JANTX2N5237](#) [2SK2267\(Q\)](#) [BUK455-60A/B](#) [MIC4420CM-TR](#) [VN1206L](#) [NDP4060](#) [SI4482DY](#)
[IPS70R2K0CEAKMA1](#) [SQD23N06-31L-GE3](#) [TK16J60W,S1VQ\(O](#) [2SK2614\(TE16L1,Q\)](#) [DMN1017UCP3-7](#) [EFC2J004NUZTDG](#)
[DMN1053UCP4-7](#) [SQJ469EP-T1-GE3](#) [NTE2384](#) [DMC2700UDMQ-7](#) [DMN2080UCB4-7](#) [DMN61D9UWQ-13](#) [US6M2GTR](#)
[DMN31D5UDJ-7](#) [DMP22D4UFO-7B](#) [DMN1006UCA6-7](#) [DMN16M9UCA6-7](#) [STF5N65M6](#) [IRF40H233XTMA1](#) [STU5N65M6](#)
[DMN6022SSD-13](#) [DMN13M9UCA6-7](#) [DMTH10H4M6SPS-13](#) [DMN2990UFB-7B](#) [IPB80P04P405ATMA2](#) [2N7002W-G](#) [MCAC30N06Y-](#)
[TP](#) [MCQ7328-TP](#) [NTMC083NP10M5L](#) [NVMFS2D3P04M8LT1G](#) [BXP7N65D](#) [BXP4N65F](#) [AOL1454G](#) [WMJ80N60C4](#) [BXP2N20L](#)
[BXP2N65D](#) [BXT1150N10J](#) [BXT1700P06M](#) [TSM60NB380CP](#) [ROG](#) [RQ7L055BGTCR](#) [DMNH15H110SK3-13](#)