

IN12E227

INDUCTIVE SENSORS • INCREASED AMBIENT TEMPERATURE

sensor inductive, M12x1 66long, Non-flush, Sn: 4, 140°C, NAMUR
Anschluss an Verstärker, Cable 5m FEP, IP68, V4A, ATEX



MECHANICAL FEATURES

Active area material of sensor	PEEK
Alignment of cable entry	Axial
Ambient temperature	-25 °C ... 140 °C
Cable infeed	Axial
Cable length	5 m
Degree of protection (IP)	IP68
Design	Cylinder, screw-thread
Housing material	Stainless steel 1.4571
Increased ambient temperatures > 80°C	+
Material of cable sheath	FEP
Mechanical mounting condition for sensor	Non-flush
Pressure-proof	-
Sensor length	66 mm
Thread length	44 mm
Thread pitch	1 mm
Thread size, metric	12
Wire cross section	0.34 mm ²

ELECTRICAL FEATURES

ATEX approval	+
Cascadable	-
Connection to amplifier	+
Min. output current	1.2 mA
Rated switching current	2.1 mA
Suitable for safety functions	-
Switching distance	4 mm
Type of electrical connection	Cable
Type of switching function	Amplifier
Type of switching output	NAMUR
With monitoring function of downstream devices	-

OTHER FEATURES

Explosion safety category for dust	ATEX dust-ex-protection, Cat. 1D
------------------------------------	----------------------------------

OTHER FEATURES

Explosion safety category for gas

ATEX gas-ex-protection, Cat. 1G

Other

Packaging dimensions	124.0mm x 28.0mm x 149.0mm
Shipping weight	0.18kg
Tariff code	85365019

Classification

ipf product group	700
eClass 8.0	27270101
eClass 9.0	27270101
eClass 9.1	27270101
ETIM-5.0	EC002714
ETIM-6.0	EC002714
ETIM-7.0	EC002714

Connection

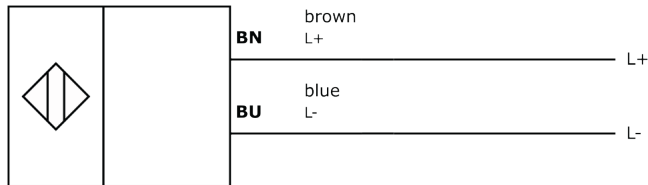

Dimensional drawing

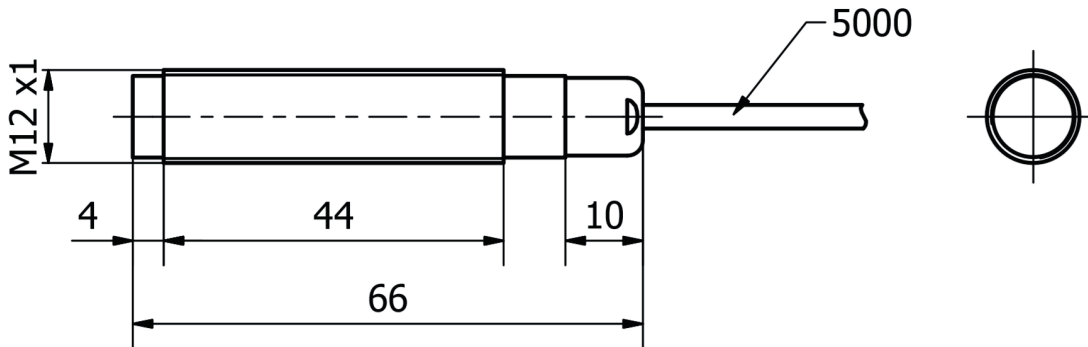

Installation



Mounting / installation may only be carried out by a qualified electrician!

Disposal



Safety warnings

Before initial operation, please make sure to follow all safety instructions that may be provided in the product information.

Never use these devices in applications where the safety of a person depends on their functionality.

LED lighting systems can generate intensive UV radiation, which can damage your eyes in case of improper use. The manufacturer cannot be held responsible for damages that result from improper use or connection.

X-ON Electronics

Largest Supplier of Electrical and Electronic Components

Click to view similar products for [Proximity Sensors](#) category:

Click to view products by [IPF ELECTRONIC](#) manufacturer:

Other Similar products are found below :

[01.001.5653.1](#) [70.340.1028.0](#) [70.360.2428.0](#) [70.364.4828.0](#) [70.810.1053.0](#) [72.360.1628.0](#) [73.363.6428.0](#) [8027AL20NL2CPXX](#) [FYCC8E1-2](#)
[9221350022](#) [922AA2W-A9P-L](#) [PLS2](#) [GL-12F-C2.5X10\(LOT3\)](#) [972AB2XM-A3N-L](#) [972AB3XM-A3P-L](#) [PS3251](#) [980659-1](#) [QT-12](#) [E2E2-](#)
[X5M41-M4](#) [E2E-X14MD1-G](#) [E2E-X2D1-G](#) [E2EX2ME2N](#) [E2EX3D1SM1N](#) [E2E-X4MD1-G](#) [E2E-X5E1-5M-N](#) [E2E-X5Y2-N](#) [E2E-X7D1-](#)
[M1J-T-0.3M-N](#) [E2K-F10MC1](#) [5M](#) [EH-302](#) [EI3010TBOP](#) [EI5515NPAP](#) [MS605AU](#) [EP175-32000](#) [IFRM04N35B1/L](#) [IFRM04P1513/S35L](#)
[IFRM06P1703/S35L](#) [IFRM08P1501/S35L](#) [IFRM12N17G3/L](#) [IFRM12P17G3/L](#) [IFRM12P3502/L](#) [IFRM12P37G1/S14L](#) [ILFK12E9189/I02](#)
[ILFK12E9193/I02](#) [IMM2582C](#) [OISN-013](#) [25.161.3253.0](#) [25.332.0653.1](#) [25.352.0653.0](#) [25.352.0753.0](#) [25.523.3253.0](#)