

IN180121

INDUCTIVE SENSORS • NORM SWITCHING DISTANCE

sensor inductive, M18x1 70long, Non-flush, Sn: 10, 10-30V DC, PNP
NO, Connector M12 3pin, IP67, Brass Nickel-plated



MECHANICAL FEATURES

Active area material of sensor	PA 6.6 (synthetic)
Alignment of cable entry	Axial
Ambient temperature	-25 °C ... 70 °C
Cable infeed	Axial
Degree of protection (IP)	IP67
Design	Cylinder, screw-thread
Housing coating	Nickel-plated
Housing material	Brass
Mechanical mounting condition for sensor	Non-flush
Pressure-proof	-
Sensor length	70 mm
Thread length	35 mm
Thread pitch	1 mm
Thread size, metric	18

ELECTRICAL FEATURES

Cascadable	-
Correction factor (aluminum)	0.3
Correction factor (brass)	0.4
Correction factor (copper)	0.2
Correction factor (St37)	1
Correction factor (stainl. steel)	0.7
Hysteresis	15 %
No-load current	15 mA
Norm measuring plate	18x18x1
Number of pins	3
Rated switching current	200 mA
Relative repeat accuracy	10 %
Reverse polarity protection	+
Short-circuit protection	+
Suitable for safety functions	-
Supply voltage	10 V ... 30 V
Switching distance	10 mm

ELECTRICAL FEATURES

Switching frequency	200 Hz
Type of electrical connection	Connector M12
Type of switching function	Normally open contact
Type of switching output	PNP
Voltage drop	2 V
Voltage type	DC
With LED display	+
With monitoring function of downstream devices	-

Other

Packaging dimensions	77.0mm x 25.0mm x 123.0mm
Shipping weight	0.07kg
Tariff code	85365019

Classification

ipf product group	200
eClass 8.0	27270101
eClass 9.0	27270101
eClass 9.1	27270101
ETIM-5.0	EC002714
ETIM-6.0	EC002714
ETIM-7.0	EC002714

Connection

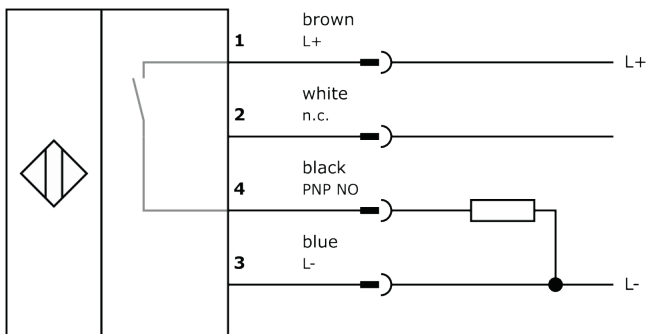

Dimensional drawing

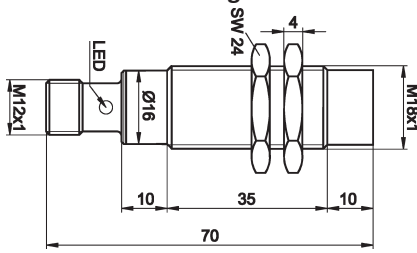

Installation



Mounting / installation may only be carried out by a qualified electrician!

Disposal



Safety warnings

Before initial operation, please make sure to follow all safety instructions that may be provided in the product information.

Never use these devices in applications where the safety of a person depends on their functionality.

LED lighting systems can generate intensive UV radiation, which can damage your eyes in case of improper use. The manufacturer cannot be held responsible for damages that result from improper use or connection.

X-ON Electronics

Largest Supplier of Electrical and Electronic Components

Click to view similar products for [Proximity Sensors](#) category:

Click to view products by [IPF ELECTRONIC](#) manufacturer:

Other Similar products are found below :

[01.001.5653.1](#) [70.340.1028.0](#) [70.360.2428.0](#) [70.364.4828.0](#) [70.810.1053.0](#) [72.360.1628.0](#) [73.363.6428.0](#) [8027AL20NL2CPXX](#) [FYCC8E1-2](#)
[9221350022](#) [922AA2W-A9P-L](#) [PLS2](#) [GL-12F-C2.5X10\(LOT3\)](#) [972AB2XM-A3N-L](#) [972AB3XM-A3P-L](#) [PS3251](#) [980659-1](#) [QT-12](#) [E2E2-](#)
[X5M41-M4](#) [E2E-X14MD1-G](#) [E2E-X2D1-G](#) [E2EX2ME2N](#) [E2EX3D1SM1N](#) [E2E-X4MD1-G](#) [E2E-X5E1-5M-N](#) [E2E-X5Y2-N](#) [E2E-X7D1-](#)
[M1J-T-0.3M-N](#) [E2K-F10MC1](#) [5M](#) [EH-302](#) [EI3010TBOP](#) [EI5515NPAP](#) [MS605AU](#) [EP175-32000](#) [IFRM04N35B1/L](#) [IFRM04P1513/S35L](#)
[IFRM06P1703/S35L](#) [IFRM08P1501/S35L](#) [IFRM12N17G3/L](#) [IFRM12P17G3/L](#) [IFRM12P3502/L](#) [IFRM12P37G1/S14L](#) [ILFK12E9189/I02](#)
[ILFK12E9193/I02](#) [IMM2582C](#) [OISN-013](#) [25.161.3253.0](#) [25.332.0653.1](#) [25.352.0653.0](#) [25.352.0753.0](#) [25.523.3253.0](#)