

IP129124

INDUCTIVE SENSORS • PRESSURE-PROOF

sensor inductive, pressure-proof, M12x1 56long, Flush, Sn: 2, 10-30V DC, 90°C, PNP NO, Connector M12 4pin, IP69K, Stainless steel 1.4305, 500bar



MECHANICAL FEATURES

Active area material of sensor	Stainless steel 1.4305
Alignment of cable entry	Axial
Ambient temperature	-25 °C ... 90 °C
Cable infeed	Axial
Degree of protection (IP)	IP69K
Design	Cylinder, screw-thread
High-pressure-proof sensors	+
Housing material	Stainless steel 1.4305
Increased ambient temperatures > 80°C	+
Max. operating pressure	500 bar
Max. peak pressure	500 bar
Mechanical mounting condition for sensor	Flush
Pressure resistance	500 bar
Pressure-proof	+
Sensor length	56 mm
Thread pitch	1 mm
Thread size, metric	12

ELECTRICAL FEATURES

Cascadable	-
Hysteresis	15 %
No-load current	10 mA
Number of pins	4
Rated switching current	200 mA
Readiness delay	100 ms
Residual ripple	5 %
Reverse polarity protection	+
Short-circuit protection	+
Suitable for safety functions	-
Supply voltage	10 V ... 30 V
Switching distance	2 mm
Switching frequency	400 Hz
Type of electrical connection	Connector M12

ELECTRICAL FEATURES

Type of switching function	Normally open contact
Type of switching output	PNP
Voltage drop	2.4 V
Voltage type	DC
With monitoring function of downstream devices	-

OTHER FEATURES

End position sensing, hydraulic cylinder	+
Metallic sensor surface	+

Other

Packaging dimensions	100mm x 0.0mm x 120mm
Shipping weight	0.03kg
Tariff code	85365019

Classification

ipf product group	208
eClass 8.0	27270101
eClass 9.0	27270101
eClass 9.1	27270101
ETIM-5.0	EC002714
ETIM-6.0	EC002714
ETIM-7.0	EC002714

Connection

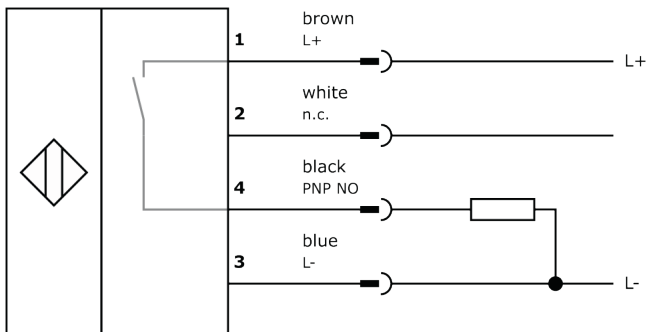

Dimensional drawing

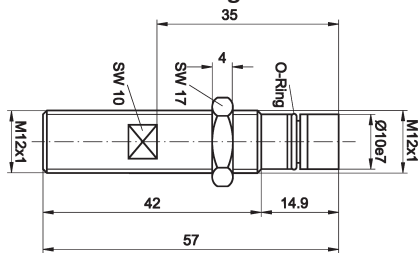

Installation



Mounting / installation may only be carried out by a qualified electrician!

Disposal



Safety warnings

Before initial operation, please make sure to follow all safety instructions that may be provided in the product information. Never use these devices in applications where the safety of a person depends on their functionality. LED lighting systems can generate intensive UV radiation, which can damage your eyes in case of improper use. The manufacturer cannot be held responsible for damages that result from improper use or connection.

X-ON Electronics

Largest Supplier of Electrical and Electronic Components

Click to view similar products for [Proximity Sensors](#) category:

Click to view products by [IPF ELECTRONIC](#) manufacturer:

Other Similar products are found below :

[01.001.5653.1](#) [70.340.1028.0](#) [70.360.2428.0](#) [70.364.4828.0](#) [70.810.1053.0](#) [72.360.1628.0](#) [73.363.6428.0](#) [8027AL20NL2CPXX](#) [FYCC8E1-2](#)
[9221350022](#) [922AA2W-A9P-L](#) [PLS2](#) [GL-12F-C2.5X10\(LOT3\)](#) [972AB2XM-A3N-L](#) [972AB3XM-A3P-L](#) [PS3251](#) [980659-1](#) [QT-12](#) [E2E2-](#)
[X5M41-M4](#) [E2E-X14MD1-G](#) [E2E-X2D1-G](#) [E2EX2ME2N](#) [E2EX3D1SM1N](#) [E2E-X4MD1-G](#) [E2E-X5E1-5M-N](#) [E2E-X5Y2-N](#) [E2E-X7D1-](#)
[M1J-T-0.3M-N](#) [E2K-F10MC1](#) [5M](#) [EH-302](#) [EI3010TBOP](#) [EI5515NPAP](#) [MS605AU](#) [EP175-32000](#) [IFRM04N35B1/L](#) [IFRM04P1513/S35L](#)
[IFRM06P1703/S35L](#) [IFRM08P1501/S35L](#) [IFRM12N17G3/L](#) [IFRM12P17G3/L](#) [IFRM12P3502/L](#) [IFRM12P37G1/S14L](#) [ILFK12E9189/I02](#)
[ILFK12E9193/I02](#) [IMM2582C](#) [OISN-013](#) [25.161.3253.0](#) [25.332.0653.1](#) [25.352.0653.0](#) [25.352.0753.0](#) [25.523.3253.0](#)