

OT430423

OPTICAL SENSORS • DIFFUSE REFLECTION SENSORS WITH BACKGROUND SUPPRESSION

sensor optical, diffuse-reflection sensor, 43x36x15mm, Sn: 30-500, 10-30V DC, 2x PNP Anticoincidence, Connector M12 4pin, IP67, Plastic ASA+PMMA, 0.5kHz, Background suppression, Polarity free red light, Point, Manual adjustment



MECHANICAL FEATURES

Ambient temperature	-25 °C ... 65 °C
Degree of protection (IP)	IP67
Design	Cuboid
Housing material	Plastic ASA
Material of optical surface	PMMA
Max. tightening torque	0.8 Nm
Reflector included in the scope of delivery	-
Sensor height	43 mm
Sensor length	36.5 mm
Sensor width	14.8 mm
Volume	Small

ELECTRICAL FEATURES

Adjustment range	30 mm ... 500 mm
Analog output 0 mA ... 20 mA	-
Analog output 0 V ... 10 V	-
Analog output -10 V ... +10 V	-
Analog output 4 mA ... 20 mA	-
Decay time	1 ms
Interference suppression	+
Max. switching distance	500 mm
No-load current	30 mA
Number of pins	4
Number of switching outputs	2
Operating voltage	10 V ... 30 V
Rated switching current	100 mA
Rated switching distance	500 mm
Response time	1 ms
Reverse polarity protection	+
Scanning function	Light-/dark-on mode
Sensing range	30 mm ... 500 mm
Setting procedure	Manual adjustment
Short-circuit protection	+

ELECTRICAL FEATURES

Switching frequency	500 Hz
Type of electrical connection	Connector M12
Type of switching function	Anticoincidence
Type of switching output	PNP
Voltage drop	1.8 V
Voltage type	DC
With LED display	+
With LED display (functional reserve)	+
With LED display (signal)	+
With other analog output	-
With time function	-

OPTICAL FEATURES

Light source	Polarity free red light
Wavelength of the sensor	660 nm
Triangulation	Background suppression
Light beam form	Point
Background suppression	+

Other

Packaging dimensions	77.0mm x 25.0mm x 123.0mm
Shipping weight	0.03kg
Tariff code	85365019

Classification

ipf product group	100
eClass 8.0	27270904
eClass 9.0	27270904
eClass 9.1	27270904
ETIM-5.0	EC002719
ETIM-6.0	EC002719
ETIM-7.0	EC002719

Connection

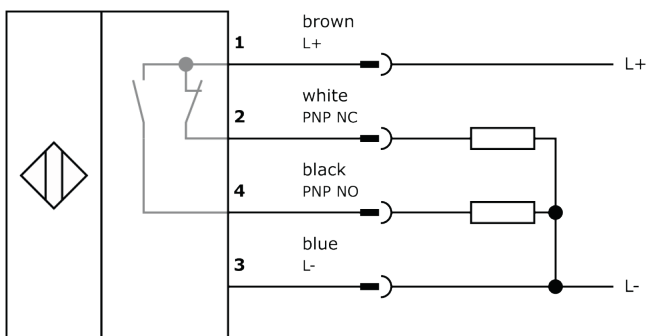

Dimensional drawing

Installation



Mounting / installation may only be carried out by a qualified electrician!

Disposal



Safety warnings

Before initial operation, please make sure to follow all safety instructions that may be provided in the product information.

Never use these devices in applications where the safety of a person depends on their functionality.

LED lighting systems can generate intensive UV radiation, which can damage your eyes in case of improper use. The manufacturer cannot be held responsible for damages that result from improper use or connection.

X-ON Electronics

Largest Supplier of Electrical and Electronic Components

Click to view similar products for [Photoelectric Sensors](#) category:

Click to view products by [IPF ELECTRONIC](#) manufacturer:

Other Similar products are found below :

[7442AD2X5FRX](#) [EX-19B-LP](#) [7443AR0X5FRX](#) [7452AD4D4NNX](#) [F3WD052C5M](#) [7655AR-04-F-1-2-RX](#) [7694ADE04DS2X](#) [FE7C-FRC6S-M](#) [PM-R24-R](#) [Q45VR2FPQ](#) [E3JUXM4MN](#) [E3S3LE21](#) [E3SCT11M1J03M](#) [E3VDS70C43S](#) [E3XNM16](#) [BR23P](#) [HOA6563-001](#) [OJ-3307-30N8](#) [OS-311A-30](#) [P34036](#) [P60001](#) [PB10CNT15PO](#) [S14132](#) [S52101](#) [S56258](#) [SH-21E](#) [SH-32R](#) [FD-SN500](#) [SU-79](#) [T36342](#) [T40300](#) [T60001](#) [PD60CNX20BP](#) [FX-302-HY](#) [PX-22](#) [PZ2-51P](#) [CYNUTX10](#) [UZB802](#) [UZB803](#) [UZFRG1](#) [UZFRG4](#) [UZFRT4](#) [UZFTT8](#) [ZX-XC4A4M](#) [E3D-R3Y1](#) [E3E23Y2US](#) [E3E-R1Y2](#) [E3SDS20E1](#) [E3TFD14N](#) [E3XR-CC4](#)