

OT590525

OPTICAL SENSORS • DIFFUSE REFLECTION SENSORS WITH BACKGROUND SUPPRESSION

sensor optical, diffuse-reflection sensor, 68x68x26mm, Sn: 200-2500, 12-24V DC, 2x PNP+NPN NC/NO, Connector M12 4pin, IP67, Plastic ABS+Plastic PC, 0.25kHz, Foreground suppression / background suppression, Infrared light, Point, Manual adjustment



MECHANICAL FEATURES

Ambient temperature	-25 °C ... 55 °C
Degree of protection (IP)	IP67
Design	Cuboid
Housing material	Plastic ABS
Material of optical surface	Plastic PC
Reflector included in the scope of delivery	-
Sensor height	68 mm
Sensor length	68 mm
Sensor width	26 mm
Shock resistance	50 g
Strong vibration / motion	+
Vibration resistance	55 Hz
Volume	Large

ELECTRICAL FEATURES

Adjustment range	200 mm ... 2500 mm
Analog output 0 mA ... 20 mA	-
Analog output 0 V ... 10 V	-
Analog output -10 V ... +10 V	-
Analog output 4 mA ... 20 mA	-
Hysteresis	10 %
Max. switching distance	2500 mm
Min. switching distance	100 mm
No-load current	45 mA
Number of pins	4
Number of switching outputs	2
Operating voltage	12 V ... 24 V
Rated control supply voltage U_s at DC	12 V ... 24 V
Rated switching current	100 mA
Rated switching distance	2500 mm
Response time	2 ms
Reverse polarity protection	+
Scanning function	Light-/dark-on mode

ELECTRICAL FEATURES

Sensing range	200 mm ... 2500 mm
Setting procedure	Manual adjustment
Short-circuit protection	+
Switching frequency	250 Hz
Type of electrical connection	Connector M12
Type of switching function	Normally closed contact/normally open contact
Type of switching output	PNP+NPN
Voltage drop	1 V
Voltage type	DC
With LED display	+
With LED display (functional reserve)	+
With LED display (signal)	+
With other analog output	-
With time function	-

OPTICAL FEATURES

Light source	Infrared light
Wavelength of the sensor	880 nm
Triangulation	Foreground suppression / background suppression
Light beam form	Point
Background suppression	+

Other

Packaging dimensions	99.0mm x 60mm x 160mm
Shipping weight	0.14kg
Tariff code	85365019

Classification

ipf product group	100
eClass 8.0	27270904
eClass 9.0	27270904
eClass 9.1	27270904
ETIM-5.0	EC002719
ETIM-6.0	EC002719
ETIM-7.0	EC002719

Connection

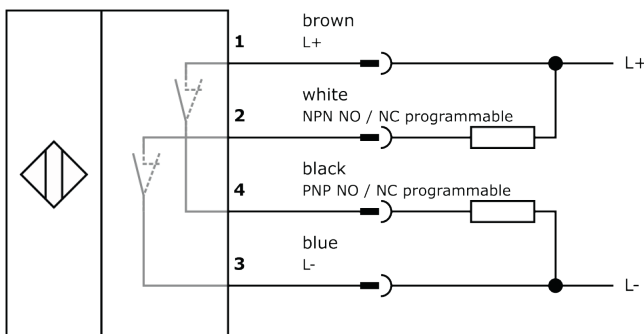

Dimensional drawing

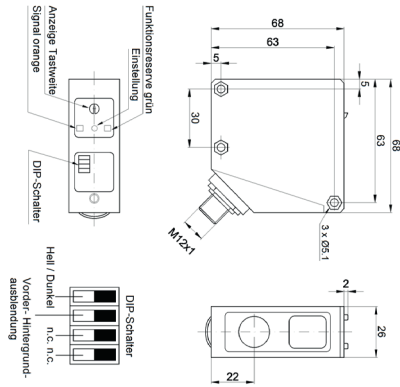

Installation



Mounting / installation may only be carried out by a qualified electrician!

Disposal



Safety warnings

Before initial operation, please make sure to follow all safety instructions that may be provided in the product information. Never use these devices in applications where the safety of a person depends on their functionality. LED lighting systems can generate intensive UV radiation, which can damage your eyes in case of improper use. The manufacturer cannot be held responsible for damages that result from improper use or connection.

X-ON Electronics

Largest Supplier of Electrical and Electronic Components

Click to view similar products for [Photoelectric Sensors](#) category:

Click to view products by [IPF ELECTRONIC](#) manufacturer:

Other Similar products are found below :

[7442AD2X5FRX](#) [EX-19B-LP](#) [7443AR0X5FRX](#) [7452AD4D4NNX](#) [F3WD052C5M](#) [7655AR-04-F-1-2-RX](#) [7694ADE04DS2X](#) [FE7C-FRC6S-M](#) [PM-R24-R](#) [Q45VR2FPQ](#) [E3JUXM4MN](#) [E3S3LE21](#) [E3SCT11M1J03M](#) [E3VDS70C43S](#) [E3XNM16](#) [BR23P](#) [HOA6563-001](#) [OJ-3307-30N8](#) [OS-311A-30](#) [P34036](#) [P60001](#) [PB10CNT15PO](#) [S14132](#) [S52101](#) [S56258](#) [SH-21E](#) [SH-32R](#) [FD-SN500](#) [SU-79](#) [T36342](#) [T40300](#) [T60001](#) [PD60CNX20BP](#) [FX-302-HY](#) [PX-22](#) [PZ2-51P](#) [CYNUTX10](#) [UZB802](#) [UZB803](#) [UZFRG1](#) [UZFRG4](#) [UZFRT4](#) [UZFTT8](#) [ZX-XC4A4M](#) [E3D-R3Y1](#) [E3E23Y2US](#) [E3E-R1Y2](#) [E3SDS20E1](#) [E3TFD14N](#) [E3XR-CC4](#)