

OT595905

OPTICAL SENSORS • DIFFUSE REFLECTION SENSORS WITH BACKGROUND SUPPRESSION

sensor optical, diffuse-reflection sensor, 68x68x26mm, Sn: 200-2500, 24-240V AC, 12-240V DC, 1x Relay contact NO (NO), Clamp, IP67, Plastic ABS+Plastic PC, 0.025kHz, Background suppression, Infrared light, Point, Manual adjustment



MECHANICAL FEATURES

Ambient temperature	-25 °C ... 55 °C
Degree of protection (IP)	IP67
Design	Cuboid
Housing material	Plastic ABS
Material of optical surface	Plastic PC
Reflector included in the scope of delivery	-
Sensor height	68 mm
Sensor length	68 mm
Sensor width	26 mm
Shock resistance	50 g
Strong vibration / motion	+
Vibration resistance	55 Hz
Volume	Large

ELECTRICAL FEATURES

Adjustment range	200 mm ... 2500 mm
Analog output 0 mA ... 20 mA	-
Analog output 0 V ... 10 V	-
Analog output -10 V ... +10 V	-
Analog output 4 mA ... 20 mA	-
Hysteresis	10 %
Max. switching distance	2500 mm
Min. switching distance	100 mm
Number of switching outputs	1
Operating voltage	24 V ... 240 V
Power consumption	5 VA
Rated control supply voltage Us at AC 50HZ	24 V ... 240 V
Rated control supply voltage Us at DC	12 V ... 240 V
Rated switching current	100 mA
Rated switching distance	2500 mm
Response time	20 ms
Reverse polarity protection	+
Scanning function	Light-/dark-on mode

ELECTRICAL FEATURES

Sensing range	200 mm ... 2500 mm
Setting procedure	Manual adjustment
Switching frequency	25 Hz
Type of electrical connection	Clamp
Type of switching function	Normally open contact (NO)
Type of switching output	Relay contact
Voltage type	AC/DC
With LED display	+
With LED display (functional reserve)	+
With LED display (signal)	+
With other analog output	-
With time function	-

OPTICAL FEATURES

Light source	Infrared light
Wavelength of the sensor	880 nm
Triangulation	Background suppression
Light beam form	Point
Background suppression	+

Other

Packaging dimensions	99.0mm x 60mm x 160mm
Shipping weight	0.14kg
Tariff code	85365019

Classification

ipf product group	100
eClass 8.0	27270904
eClass 9.0	27270904
eClass 9.1	27270904
ETIM-5.0	EC002719
ETIM-6.0	EC002719
ETIM-7.0	EC002719

Connection

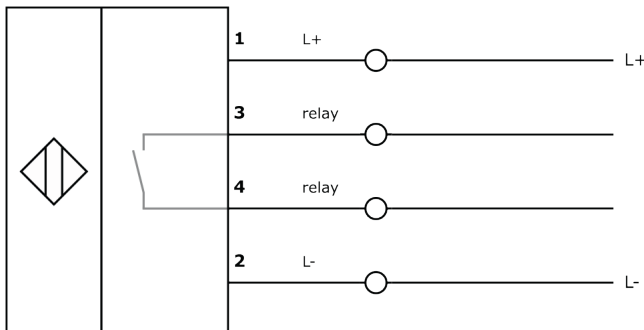

Dimensional drawing

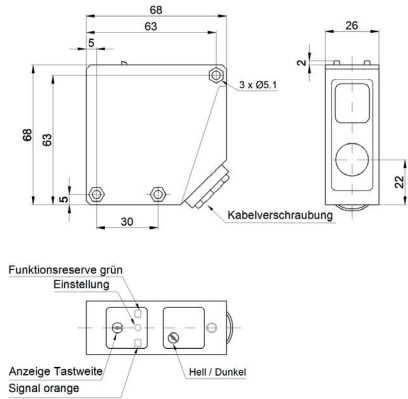

Installation



Mounting / installation may only be carried out by a qualified electrician!

Disposal



Safety warnings

Before initial operation, please make sure to follow all safety instructions that may be provided in the product information. Never use these devices in applications where the safety of a person depends on their functionality. LED lighting systems can generate intensive UV radiation, which can damage your eyes in case of improper use. The manufacturer cannot be held responsible for damages that result from improper use or connection.

X-ON Electronics

Largest Supplier of Electrical and Electronic Components

Click to view similar products for [Photoelectric Sensors](#) category:

Click to view products by [IPF ELECTRONIC](#) manufacturer:

Other Similar products are found below :

[7442AD2X5FRX](#) [EX-19B-LP](#) [7443AR0X5FRX](#) [7452AD4D4NNX](#) [F3WD052C5M](#) [7655AR-04-F-1-2-RX](#) [7694ADE04DS2X](#) [FE7C-FRC6S-M](#) [PM-R24-R](#) [Q45VR2FPQ](#) [E3JUXM4MN](#) [E3S3LE21](#) [E3SCT11M1J03M](#) [E3VDS70C43S](#) [E3XNM16](#) [BR23P](#) [HOA6563-001](#) [OJ-3307-30N8](#) [OS-311A-30](#) [P34036](#) [P60001](#) [PB10CNT15PO](#) [S14132](#) [S52101](#) [S56258](#) [SH-21E](#) [SH-32R](#) [FD-SN500](#) [SU-79](#) [T36342](#) [T40300](#) [T60001](#) [PD60CNX20BP](#) [FX-302-HY](#) [PX-22](#) [PZ2-51P](#) [CYNUTX10](#) [UZB802](#) [UZB803](#) [UZFRG1](#) [UZFRG4](#) [UZFRT4](#) [UZFTT8](#) [ZX-XC4A4M](#) [E3D-R3Y1](#) [E3E23Y2US](#) [E3E-R1Y2](#) [E3SDS20E1](#) [E3TFD14N](#) [E3XR-CC4](#)