

## OTQ40273

### OPTICAL SENSORS • DIFFUSE REFLECTION SENSORS WITH BACKGROUND SUPPRESSION

sensor optical, diffuse-reflection sensor, 45x6,2x4mm, Sn: 50, 11-30V DC, 1x PNP/NPN Push-pull, Cable connector M8 4pin 0.2m PVC, IP65, Plastic ASA+PMMA, 1kHz, Background suppression, Polarity free red light, Point



#### MECHANICAL FEATURES

Ambient temperature	-10 °C ... 50 °C
Cable length	0.2 m
Degree of protection (IP)	IP65
Design	Cuboid
Housing material	Plastic ASA
Material of cable sheath	PVC
Material of optical surface	PMMA
Max. tightening torque	0.25 Nm
Number of cores	3
Reflector included in the scope of delivery	-
Sensor height	44.8 mm
Sensor length	6.2 mm
Sensor width	4 mm
Volume	Small
Wire cross section	0.1 mm <sup>2</sup>

#### ELECTRICAL FEATURES

Adjustment range	50 mm ... 50 mm
Analog output 0 mA ... 20 mA	-
Analog output 0 V ... 10 V	-
Analog output -10 V ... +10 V	-
Analog output 4 mA ... 20 mA	-
Decay time	0.5 ms
Interference suppression	+
Max. switching distance	50 mm
No-load current	30 mA
Number of pins	4
Number of switching outputs	1
Operating voltage	11 V ... 30 V
Rated switching current	50 mA
Rated switching distance	50 mm
Response time	0.5 ms
Reverse polarity protection	+

## ELECTRICAL FEATURES

Sensing range	50 mm ... 50 mm
Short-circuit protection	+
Switching frequency	1000 Hz
Type of electrical connection	Cable connector M8
Type of switching function	Push-pull
Type of switching output	PNP/NPN
Voltage drop	2 V
Voltage type	DC
With LED display	+
With LED display (functional reserve)	+
With LED display (signal)	+
With other analog output	-
With time function	-

## OPTICAL FEATURES

Light source	Polarity free red light
Light spot	3.14 mm <sup>2</sup>
Wavelength of the sensor	660 nm
Triangulation	Background suppression
Light beam form	Point
Background suppression	+
Small light beam diameter	+

## Other

Packaging dimensions	75.0mm x 17.0mm x 95.0mm
Shipping weight	0.02kg
Tariff code	85365019

## Classification

ipf product group	100
eClass 8.0	27270904
eClass 9.0	27270904
eClass 9.1	27270904
ETIM-5.0	EC002719
ETIM-6.0	EC002719
ETIM-7.0	EC002719

## Connection

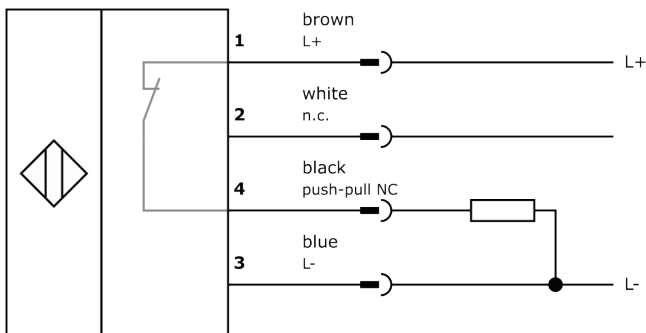

## Dimensional drawing

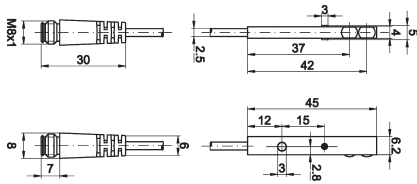

## Installation



Mounting / installation may only be carried out by a qualified electrician!

## Disposal



## Safety warnings

Before initial operation, please make sure to follow all safety instructions that may be provided in the product information. Never use these devices in applications where the safety of a person depends on their functionality. LED lighting systems can generate intensive UV radiation, which can damage your eyes in case of improper use. The manufacturer cannot be held responsible for damages that result from improper use or connection.

## X-ON Electronics

Largest Supplier of Electrical and Electronic Components

*Click to view similar products for [Photoelectric Sensors](#) category:*

*Click to view products by [IPF ELECTRONIC](#) manufacturer:*

Other Similar products are found below :

[7442AD2X5FRX](#) [EX-19B-LP](#) [7443AR0X5FRX](#) [7452AD4D4NNX](#) [F3WD052C5M](#) [7694ADE04DS2X](#) [FE7C-FRC6S-M](#) [FX-305](#) [PM-R24-R](#)  
[Q45VR2FPQ](#) [13104RQD07](#) [E3JUXM4MN](#) [E3L2DC4](#) [E3S3LE21](#) [E3SDS20E21](#) [E3VDS70C43S](#) [E3XNM16](#) [BR23P](#) [HOA6563-001](#) [OJ-](#)  
[3307-30N8](#) [OS-311A-30](#) [P32013](#) [P34036](#) [P43004](#) [P60001](#) [PB10CNT15PO](#) [S14132](#) [935286-000](#) [S52101](#) [S56258](#) [FD-SN500](#) [FE7B-](#)  
[FDRB6-M](#) [SU-79](#) [T36342](#) [T40300](#) [T60001](#) [PD60CNX20BP](#) [FX-302-HY](#) [FZS](#) [PM-T64W](#) [PZ2-51P](#) [CX-491-P-J](#) [CYNUTX10](#) [UZB802](#)  
[UZB803](#) [UZFRG1](#) [UZFRG4](#) [UZFRT4](#) [UZFTT8](#) [XUM2BKCNL2T](#)