

PG206523

LASER SENSORS • FORKED LIGHT BARRIER

sensor laser, fork, 34x6x52mm, fork width 20mm, 12-30V DC, 1x PNP/NPN NC/NO, Cable connector M12 4pin 1m PUR (Polyurethane), IP67, Aluminum+Glass, Infrared light, 25kHz

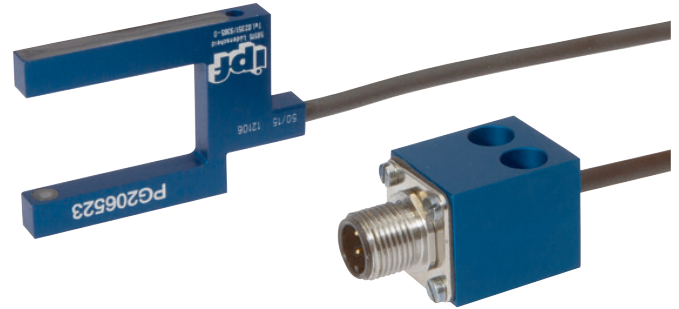

MECHANICAL FEATURES

Ambient temperature	-20 °C ... 50 °C
Aperture diameter	0.8 mm
Cable length	1 m
Degree of protection (IP)	IP67
Design	Cuboid
Diameter detection	-
Fork depth	33.5 mm
Fork light barrier design	Furcate
Fork width	20 mm
Housing material	Aluminum
Installation bracket	-
Material of cable sheath	PUR (Polyurethane)
Material of optical surface	Glass
Punching tools	+
Sensor height	34 mm
Sensor length	6 mm
Sensor width	51.5 mm

ELECTRICAL FEATURES

Analog output 0 V ... 10 V	-
Analog output 4 mA ... 20 mA	-
Connection to amplifier	-
Decay time	0.02 ms
Dynamic switching output	-
Equipment protection class	Protection class 3
No-load current	20 mA
Number of pins	4
Number of switching outputs	1
Operating voltage	12 V ... 30 V
Rated switching current	100 mA
Relative repeat accuracy	0.01 mm
Repeatability +/-	10 µm
Response time	0.02 ms

ELECTRICAL FEATURES

Reverse polarity protection	+
Scanning function	Light-/dark-on mode
Short-circuit protection	+
Switching frequency	25000 Hz
Type of electrical connection	Cable connector M12
Type of switching function	Normally closed contact/normally open contact
Type of switching output	PNP/NPN
Type of the forked light barrier	Standard
Voltage type	DC
With communication interface, analog	-
With communication interface, RS-232	-
With other analog output	-
With time function	-

OPTICAL FEATURES

Min. object size	0.01 mm
Resolution	400 µm
Light beam form	Point
Laser class	Class 1

OTHER FEATURES

Feeding technology	+
--------------------	---

Other

Packaging dimensions	70mm x 40mm x 125.0mm
Shipping weight	0.1kg
Tariff code	85365019

Classification

ipf product group	170
eClass 8.0	27270909
eClass 9.0	27270909
eClass 9.1	27270909
ETIM-5.0	EC002720
ETIM-6.0	EC002720
ETIM-7.0	EC002720

Connection

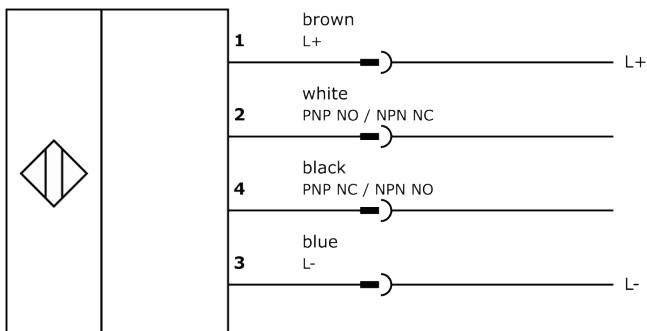

Dimensional drawing

Installation



Mounting / installation may only be carried out by a qualified electrician!

Disposal



Safety warnings

Before initial operation, please make sure to follow all safety instructions that may be provided in the product information.

Never use these devices in applications where the safety of a person depends on their functionality.

LED lighting systems can generate intensive UV radiation, which can damage your eyes in case of improper use. The manufacturer cannot be held responsible for damages that result from improper use or connection.

X-ON Electronics

Largest Supplier of Electrical and Electronic Components

Click to view similar products for [Photoelectric Sensors](#) category:

Click to view products by [IPF ELECTRONIC](#) manufacturer:

Other Similar products are found below :

[7442AD2X5FRX](#) [EX-19B-LP](#) [EX-19SB-PN](#) [7443AR0X5FRX](#) [7452AD4D4NNX](#) [7694ADE04DS2X](#) [FE7C-FRC6S-M](#) [FX-305](#) [PM-R24-R](#)
[Q45VR2FPQ](#) [13104RQD07](#) [E3JUXM4MN](#) [E3L2DC4](#) [E3S3LE21](#) [E3SCT11M1J03M](#) [E3SDS20E21](#) [E3VDS70C43S](#) [E3XNM16](#) [BR23P](#)
[HOA6563-001](#) [OJ-3307-30N8](#) [OS-311A-30](#) [P32013](#) [P34036](#) [P43004](#) [P60001](#) [PB10CNT15PO](#) [S14132](#) [935286-000](#) [S52101](#) [S56258](#) [FD-](#)
[SN500](#) [FE7B-FDRB6-M](#) [SU-79](#) [T36342](#) [T40300](#) [T60001](#) [PD60CNX20BP](#) [FX-302-HY](#) [FZS](#) [PM-T64W](#) [PZ2-51P](#) [CX-491-P-J](#) [CYNUTX10](#)
[UZB802](#) [UZB803](#) [UZFRG1](#) [UZFRG4](#) [UZFRT4](#) [UZFTT8](#)