

VK300F21

CONNECTION TECHNOLOGY • CABLE SOCKETS / CONNECTORS PRE-ASSEMBLED ON TWO SIDES

, 3m, M12 Female (socket) 4pin Angular, M12 Male (plug) 4pin Straight, 4x0.34mm², PUR (Polyurethane), 240V, IP67, Suitable for trailing chain and torsion resistant, Oil and cooling lubricants, Welding area, Silicone-free



MECHANICAL FEATURES

Cable infeed of A connection	Angular
Cable infeed of B connection	Straight
Cable length	3 m
Degree of protection (IP)	IP67
Material of cable sheath	PUR (Polyurethane)
Number of cores	4
Perm. ambient temperature of cable, fixed cable	-25 °C ... 80 °C
Suitable for trailing chain	+
Torsion cycles	+/-360°/m, ≥ 2 million cycles
Trailing chain cycles	5 million cycles
Version	Connection cable
Wire assembly	42 x 0.1mm
Wire cross section	0.34 mm ²

ELECTRICAL FEATURES

Number of pins of A connection	4
Number of pins of B connection	4
Rated voltage	240 V
Type of A electrical connection	M12
Type of B electrical connection	M12
Type of plug-in contact, A connection	Female (socket)
Type of plug-in contact, B connection	Male (plug)

OTHER FEATURES

Flame retardant	In accordance with EN 60332-2-2
Free of LABS	+
Halogen-free	+
Hydrolysis-proof	+
IR-networked	-
Oil and cooling lubricants	+
Ozone and UV-resistant	+
Silicone-free	+
Suitable for trailing chain and torsion resistant	+

OTHER FEATURES

Welding area +

Other

Packaging dimensions	160mm x 25.0mm x 160mm
Shipping weight	0.12kg
Tariff code	85444290

Classification

ipf product group	851
eClass 8.0	27279218
eClass 9.0	27060311
eClass 9.1	27060311
ETIM-5.0	EC001855
ETIM-6.0	EC001855
ETIM-7.0	EC001855

Connection

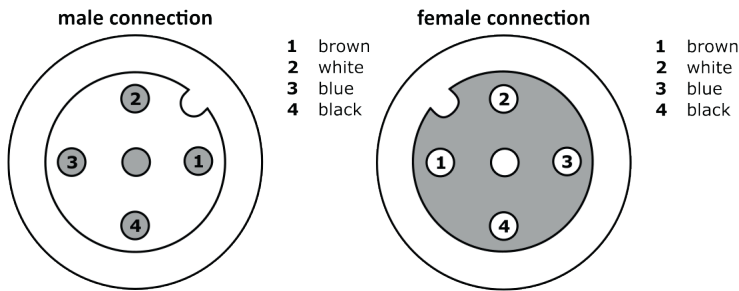

Dimensional drawing

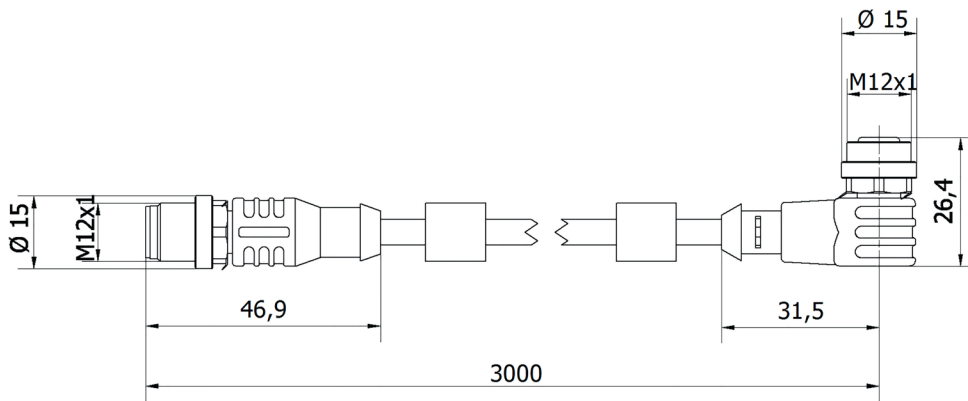

Installation



Mounting / installation may only be carried out by a qualified electrician!

Disposal



Safety warnings

Before initial operation, please make sure to follow all safety instructions that may be provided in the product information. Never use these devices in applications where the safety of a person depends on their functionality. LED lighting systems can generate intensive UV radiation, which can damage your eyes in case of improper use. The manufacturer cannot be held responsible for damages that result from improper use or connection.

X-ON Electronics

Largest Supplier of Electrical and Electronic Components

Click to view similar products for [Sensor Cables / Actuator Cables](#) category:

Click to view products by [IPF ELECTRONIC](#) manufacturer:

Other Similar products are found below :

[60963](#) [60964](#) [M83513/19-F01CP](#) [703000D02F2002](#) [703000D02F300](#) [703001D02F0602](#) [703001D02F1201](#) [703001D02F300](#)
[704000D02F120](#) [773032K02F030](#) [802027107404-1](#) [802027213811-1](#) [804001A09M150](#) [805001A09M0502](#) [84914-0235](#) [84914-0237](#)
[885030A09M010](#) [885030A09M020](#) [8R4J30E03C3003](#) [1200651332](#) [1200651713](#) [1200660844](#) [1200660845](#) [1200661173](#) [1200680071](#)
[1200720053](#) [1200720081](#) [1200720099](#) [1200720217](#) [1200800231](#) [1200860125](#) [1200870123](#) [1200980102](#) [1200650218](#) [1200650298](#)
[1200660183](#) [1200660782](#) [1200660849](#) [1200661295](#) [1200661297](#) [1200661342](#) [1200661343](#) [1200670080](#) [1200670220](#) [1200680331](#)
[1200720252](#) [1200720255](#) [1200720597](#) [1200730184](#) [1200860344](#)