



Digital flexible Neon Strip



Product Description

This digital Neon LED is made of Silicon material
Fire resistance, Anti - UV, Anti - Corrosion and deformation
resistance Diffused color without any light spots,
Emitting angle 180 Degrees Standard 5 meters/ reel,
but can be customized within 50meters



The cutting unit length is 50mm/12V, 100mm/24V
per section

JST SM connector on input and output side, SPI

Control 20Pixels/Meter DC12V, 10Pixels/Meter

DC24V Waterproof IP65 Rated for outdoor installation



Product Datasheet

Product Number	N012060CC3SF	N012060CB3SF
Light Source	SMD 5050 RGB	
Beam Angle	120°	
LED Quantity	60 leds/m	
Material	Silicon	
Color Sequence	RGB	
Pixel/M	10Pixels-SPI	20Pixels-WS2811 IC
Operating Voltage	DC24V	DC12V
Power (W)	12 W/M	
Dimension	5000*12*22 MM	
IP	IP 65	
Net Weight	1.5kg/roll (5m)	
Operation Temperature	- 40 ~ 50 °C	

Remark:12V version color output sequence is GRB

Application



Hotels, restaurants, nights clubs.

Advertising signs, brightening.



Back lighting, edge lighting.

Dancefloor background.



Correct bending way

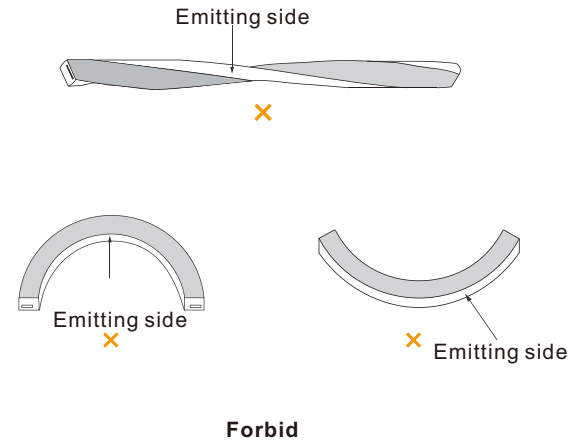
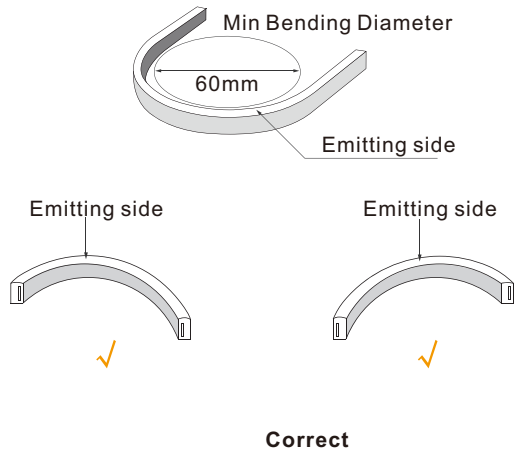

Correct bending

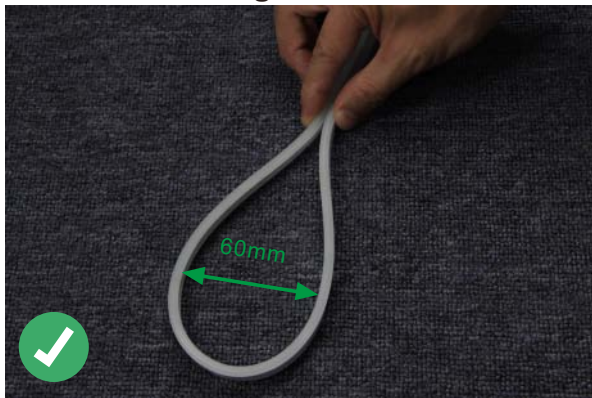

Face to the lighting surface and fold the strip.
The minimum bending diameter is 80mm

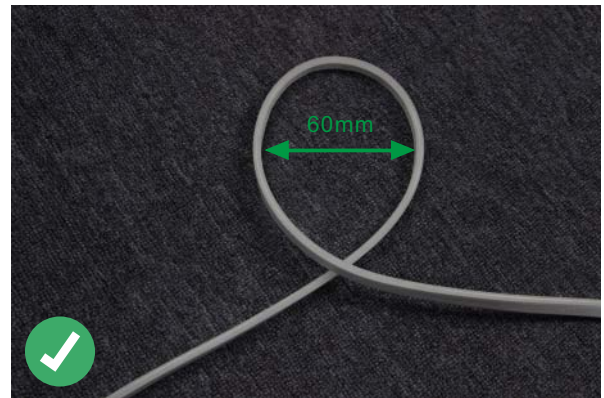

Lighting surface upwards and the strip can be bent to right or left naturally, The minimum bending diameter is 100mm

Incorrect bending way



Face to the side surface (as the picture shows),
Do not bend it downward to damage the strip.



(as the picture shows) please do not twist the strip,
or it will be damaged



Installation





clips
50x8x13mm(LxWxH)

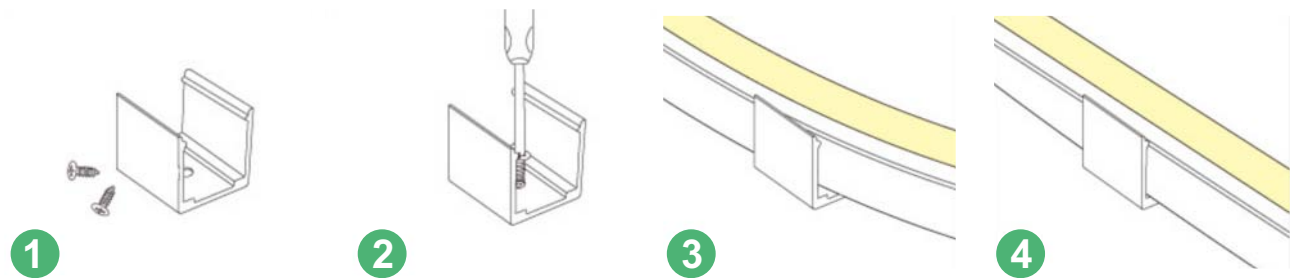
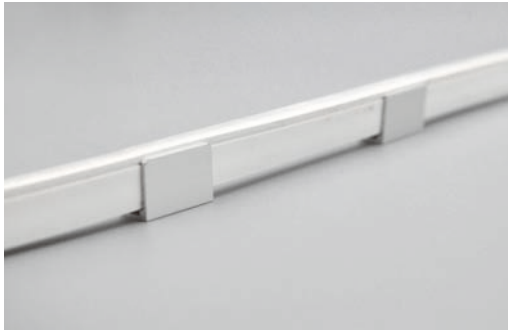

profile
1000x8x13mm(LxWxH)

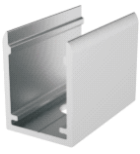
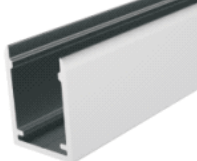

Accessory(Excluded)

Name	Aluminum clip	Aluminum extrusion	Silicone glue
installation			
Remarks	L: 20 mm	L:1000 mm	10 ml/pc

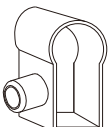
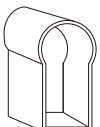
Name	Standard Connector	End cap
Style		



Outline Dimension (unit:mm)

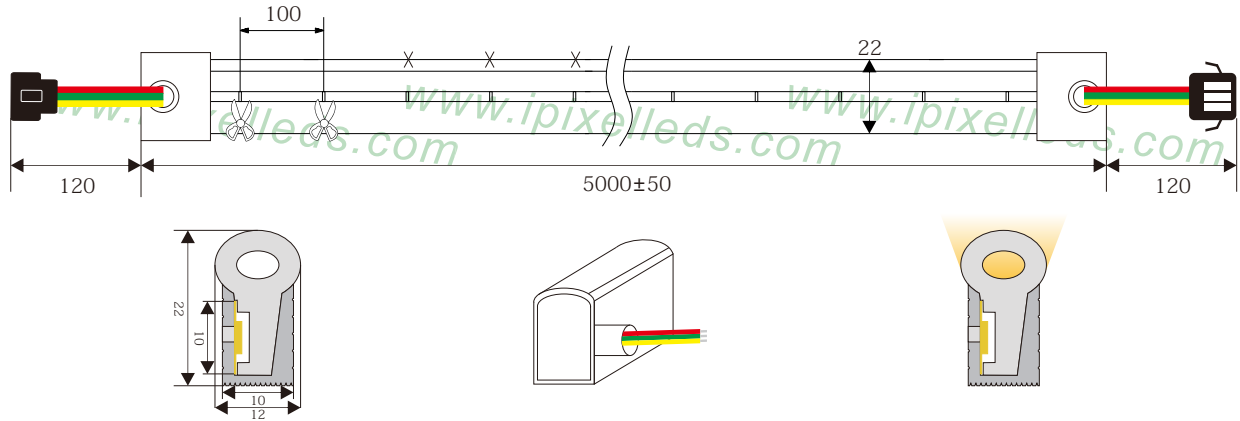

Connection

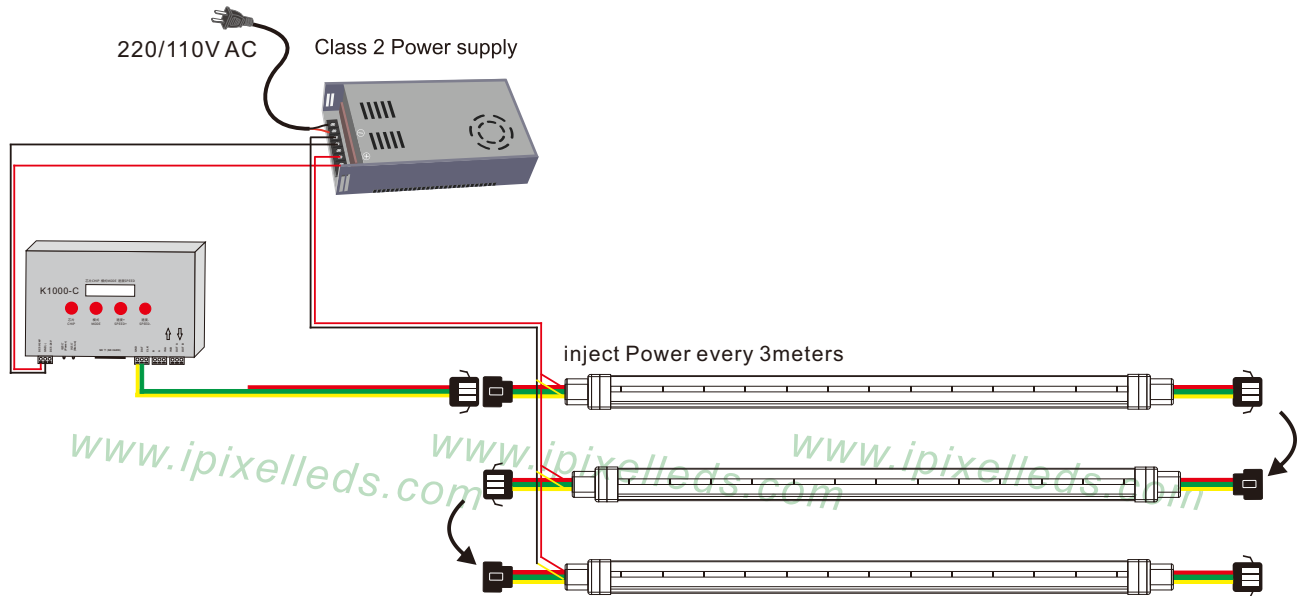

Product packaging

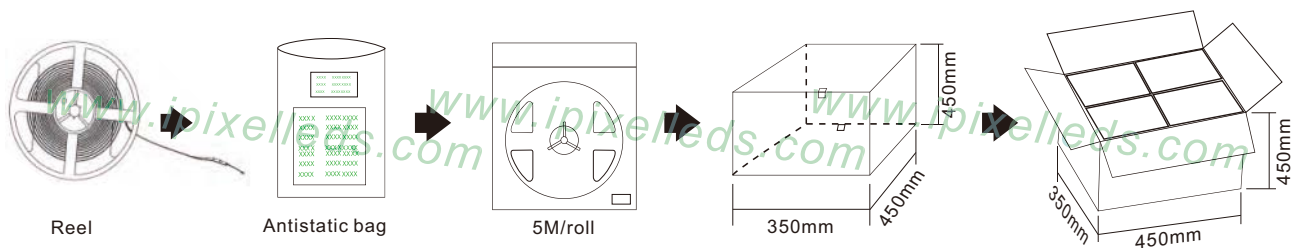

Product number	Standard length	Quantity / volume	outer carton size	Weight(kg)/reel
N012060CC3SF	5M	240 Reels	L450xW350xH450mm	1.5kg
/				/
/				/
/				/
/				/

X-ON Electronics

Largest Supplier of Electrical and Electronic Components

Click to view similar products for [LED Lighting Bars and Strips](#) category:

Click to view products by [IPIXEL LED](#) manufacturer:

Other Similar products are found below :

[ZLF0310W62524](#) [LF1D-F2F-2W-300](#) [00215258](#) [HH-SWW320F010W12-COB IP20](#) [HH-SWW320F010W24-COB IP20](#) [HH-SWW528F210W12-COB IP65](#) [HH-SG528F010W24-COB IP20](#) [LF2D-EN2F-2W-A](#) [LFBHL-SW827-24V-8S63-20](#) [N006120BC1LZ](#) (GOLDEN YELLOW) [S010060CB1LZ](#) (NEUTRAL WHITE IP65) [S010060CC1LZ](#) (WARM WHITE IP65) [2633830000](#) [HH-SX72F008W24-2835 CW WHITE PCB IP20](#) [HH-SX180F010W24 -2835 WW WHITE PCB IP20](#) [HH-SX72F008W24-2835 NW WHITE PCB IP20](#) [HH-SX144F008W24 -2835 NW WHITE PCB IP20](#) [HH-SX180F010W24 -2835 NW WHITE PCB IP20](#) [HH-SX144F008W24 -2835 CW WHITE PCB IP20](#) [HH-SX144F008W24 -2835 WW WHITE PCB IP20](#) [HH-SX180F010W24 -2835 CW WHITE PCB IP20](#) [N008120BB1LZ](#) (BLUE) [00219015](#) [10001611](#) [10001612](#) [10001613](#) [10001617](#) [10001618](#) [10001619](#) [10001622](#) [10001623](#) [10001655](#) [10001657](#) [10001664](#) [10001670](#) [10001675](#) [10001681](#) [10001683](#) [10001690](#) [PUUA-100LLL-NK2P](#) [QAUR1161L030](#) [HC-F12V-3535 PCBA](#) [HC-F12V-F50-3L-WS2811](#) [HC-F12V-WS2811-3535](#) [HC-F5V-144L-144LED-B-WS2813 IP20](#) [HC-F5V-144L-144LED-B-WS2813 IP65](#) [HC-F5V-144L-144LED-W-WS2813 IP20](#) [HC-F5V-30L-30LED-B-WS2813 IP20](#) [HC-F5V-30L-30LED-W-WS2813 IP20](#) [HC-F5V-60L-60LED-B-WS2813 IP20](#)