

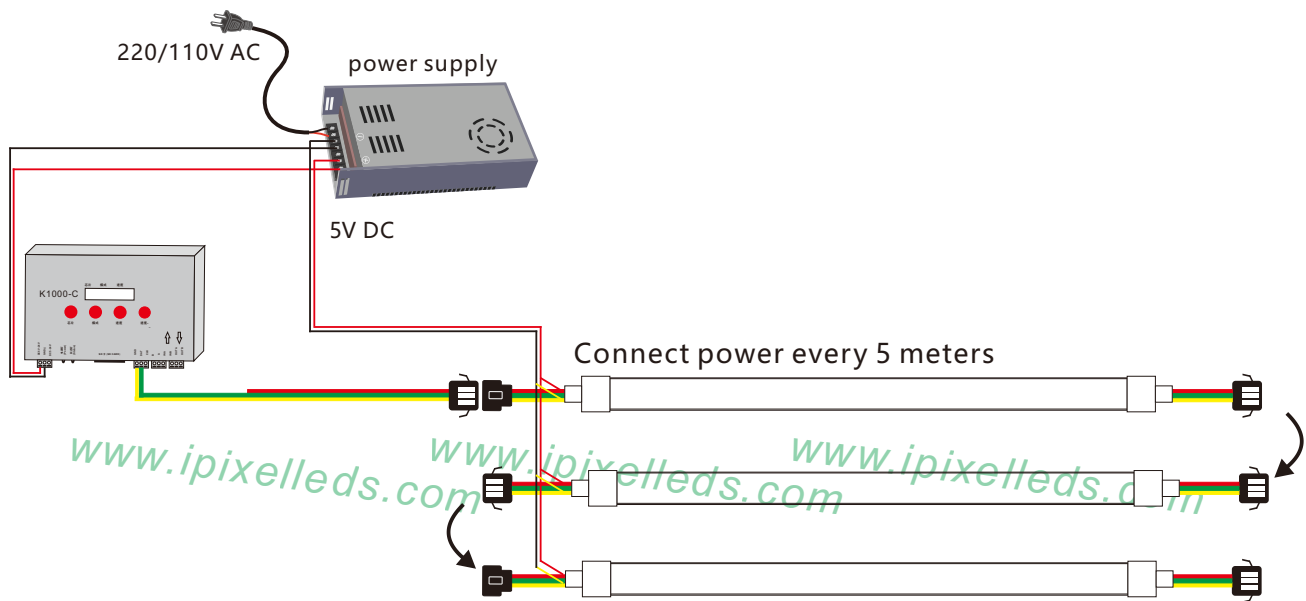



◆ Order number

DC5V	RGB	White PCB	IP20	N013060CA3SA1/C1
DC5V	RGB	White PCB	IP65	N013060CA3SA1/C2

◆ Wiring diagram



◆ Accessories

Name	PC clip	Remarks	The front cover	End cap
Picture				
Remarks	25x7x5.5mm	10 ml /pc		

◆ Correct bending way

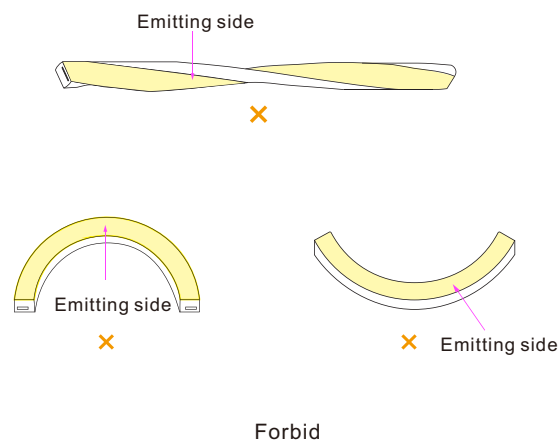
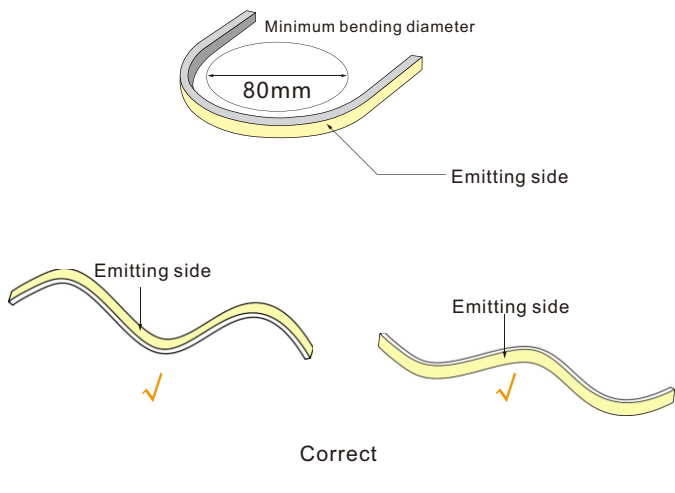

◆ Accessories



PC clip
25x7x5.5mm(LxWxH)

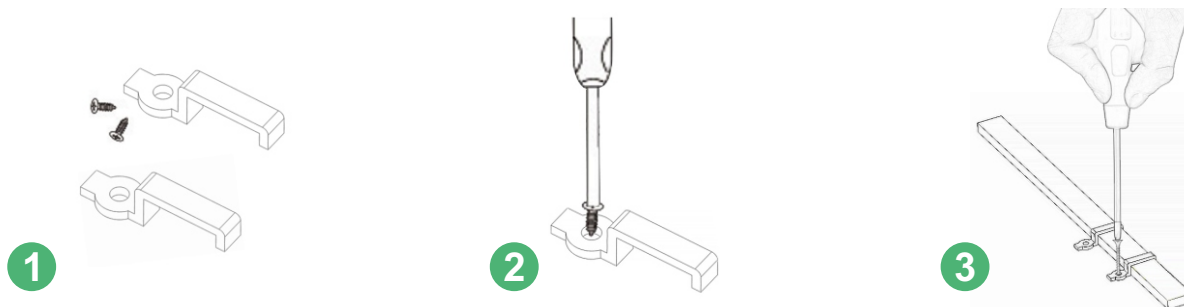
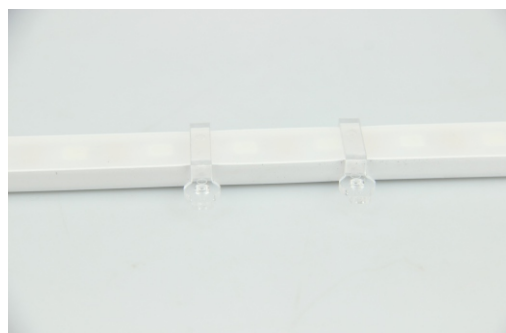

Note: The parameters are subject to change without notice!

X-ON Electronics

Largest Supplier of Electrical and Electronic Components

Click to view similar products for [LED Lighting Bars and Strips](#) category:

Click to view products by [IPIXEL LED](#) manufacturer:

Other Similar products are found below :

[LFBLL-SW823-24V-8S125-20](#) [LFBHL-SW927-24V-8S63-20](#) [RF-G30HI3510-241202081-A0 IP20](#) [RF-GW2H39W19-2406020I1-A1 IP20](#)
[HH-SX144F008W24 -2835 WW WHITE PCB IP20](#) [HH-SRGB840F010W24-COB](#) [N004120BB1LZ \(6000K\)](#) [N004120BC1LZ \(3000K\)](#)
[N008120BB1LZ \(BLUE\)](#) [N008120BC1LZ \(4000K\)](#) [S008144CA4SA1/C1 \(RGB+4000K IP20\)](#) [S0121134ZC3PZ](#) [COB-480-CW-24-10W](#)
[HQS-14.4W-60LED-RGB-WP-12V-5M](#) [N013060CA3SA1](#) [HQS-12W-60LED-W-WP-24V-5M](#) [UQS-COB-12W-NW-24V-5M](#) [HH-](#)
[SNW480F208W24-COB-R](#) [HQS-12W-60LED-NW-WP-12V-5M](#) [S012120BC1HZ \(WARM WHITE\)](#) [HQS-6W-60LED-WW-WP-24V-5M](#)
[S020240BC1DC0/C3](#) [S012060CB4SA1/C2](#) [HQS-12W-60LED-WW-WP-24V-5M](#) [HH-SW480F008W24-COB-R](#) [UQS-COB-8W-WW-12V-](#)
[5M](#) [HH-SWW480F008W24-COB-R](#) [COB-480-WW-24-10W](#) [HQS-6W-60LED-NW-WP-12V-5M](#) [S012060CC4DC0/C3](#) [S012048CB4PZ](#)
[\(RGB+W:3000K\)](#) [HQS-9.6W-120LED-NW-WP-12V-5M](#) [S012480ZB1SF \(WARM WHITE IP20\)](#) [HQS-6W-60LED-WW-12V-5M](#)
[S012120BC1HZ \(COLD WHITE\)](#) [HQS-6W-60LED-W-WP-12V-5M](#) [HQS-6W-60LED-W-12V-5M](#) [HQS-9.6W-120LED-NW-24V-5M](#) [HQS-](#)
[9.6W-120LED-NW-12V-5M](#) [UQS-COB-8W-NW-24V-5M](#) [HQS-12W-60LED-WW-12V-5M](#) [S012480ZB1SF \(COLD WHITE IP20\)](#) [HH-](#)
[SRGB60F310W12-5050 WHITE PCB IP65A](#) [S010120BC3SM/C1](#) [UQS-COB-12W-W-24V-5M](#) [HH-SRGB60F010W12-5050 WHITE PCB](#)
[IP20](#) [HQS-6W-60LED-NW-12V-5M](#) [HH-SW60F008W12-3528 CW WHITE PCB IP20](#) [HQS-6W-60LED-NW-24V-5M](#) [S004060BB3PZ/C2](#)