

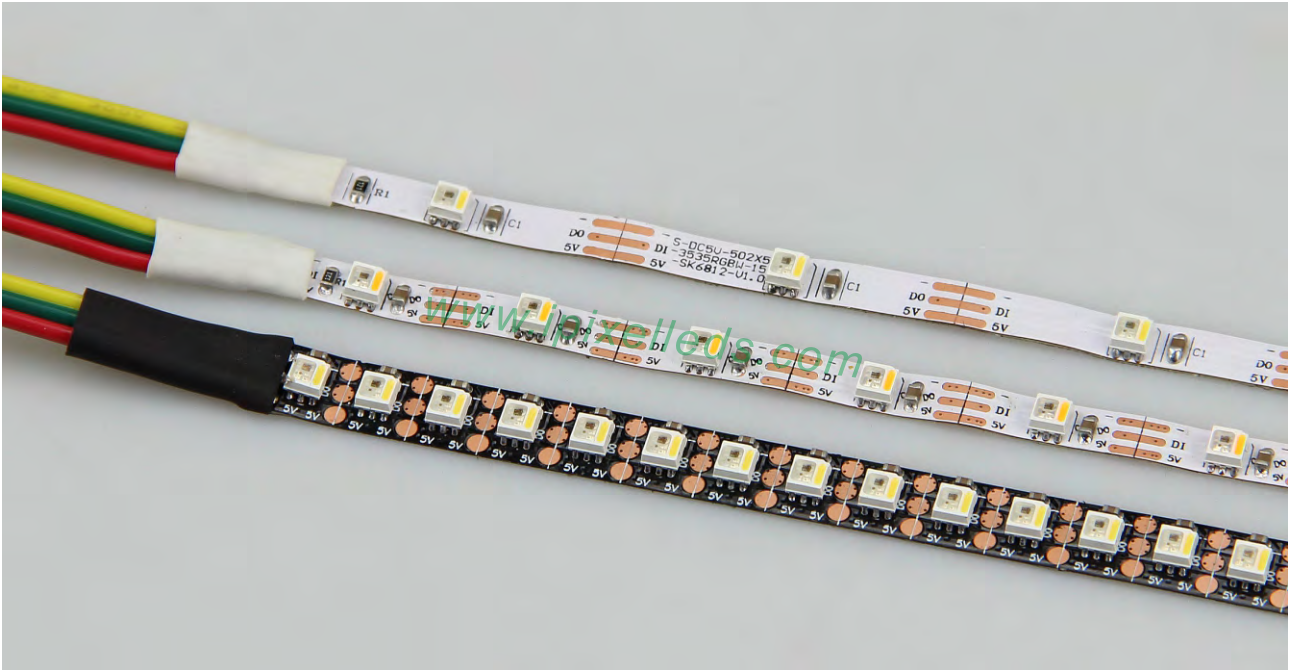

SMD3535 RGBW Addressable LED strip



Product Description

This SMD 3535 RGBW Addressable LED Strip with 60LEDs and 60Pixels per meter(individually controlled every LEDs)

Compare with RGB led strip , there are one more white color, more lighting effects for us,The color(CCT) of White can be warm white,nature white,pure white and cold white.



Colors are rich and varied, It can realize different changing effects in the controller.

5mm width, Light and thin: suitable for installation in narrow space. Easy and free cutting and welding: You can cut and weld all kinds of length according to the above cutting mark.

5 Meter per reel, Customized sizes are also available.



Product Datasheet

Product Number	S005060DA4SA1
Light Source	SMD 3535 RGBW
Beam Angle	120°
LED Quantity	60 leds/m
CCT	RGBW 2800-3200 K 4000-4500 K 6000-6500 K 9000-13000K
Wavelength (nm/m)	R:620-630 G:515-525 B:460-470
Protocol	SK6812
PCB Color	White/Black
Operating Voltage	DC5V
Power (W)	13W/M
Size (mm)	L 5000* W 5
IP	IP 20/IP 65
Net Weight	0.13kg/roll
Operation Temperature	- 40 ~ 50 °C

Application



Hotels ,restaurants, nights clubs, edge light

Recreational machines, playstation



Living rooms, coffee / wine bars, back lighting

TV, dancefloor background, shopping malls,

Strip IP Rate





Curve Lune

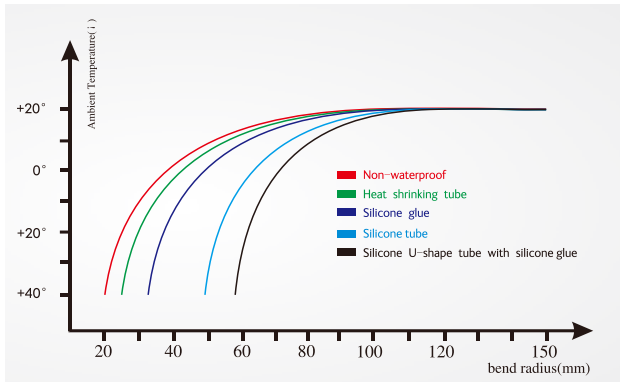
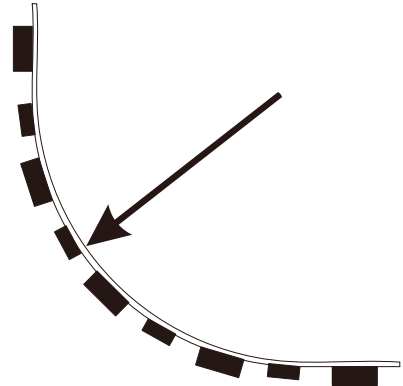
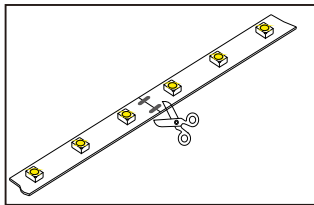

Diagram2: Bend Curve



Installation



Cut in specific location

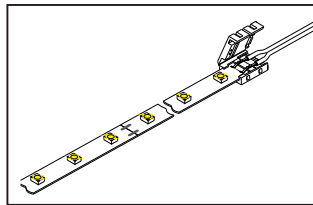

Put the PCB in the space between clip and connector, make the clips exactly aim at welding point

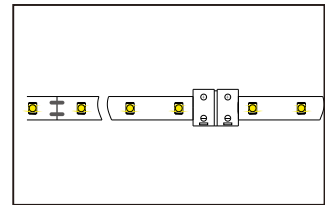

Close the cover of connector

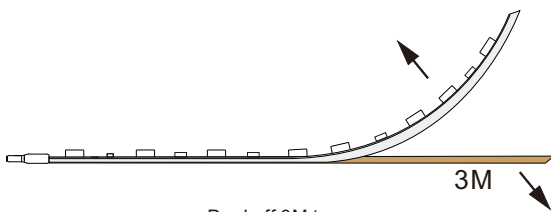

Peel off 3M tape

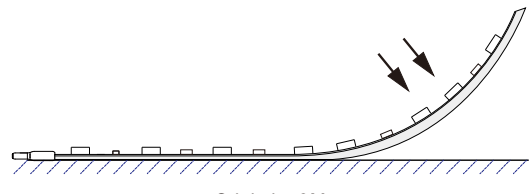

Stick the 3M

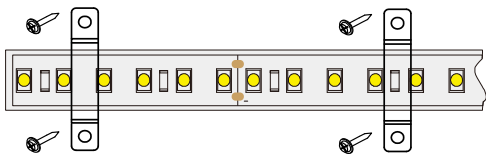

Install with clips

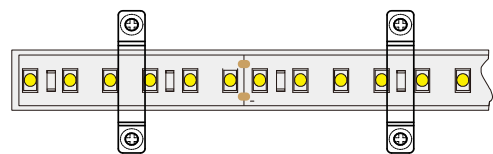

Fix with screws

Accessories (Excluded)



Screws



Silicone clip



End cap



Outline Dimension (unit:mm)

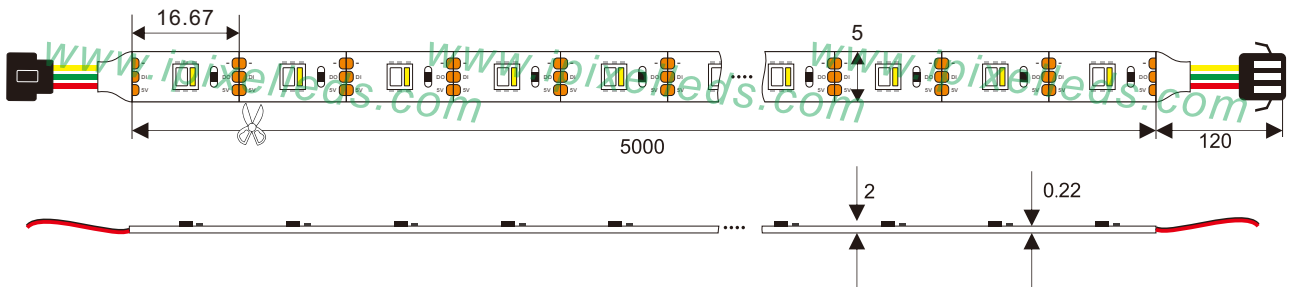

Connection

RGBW LED strip light

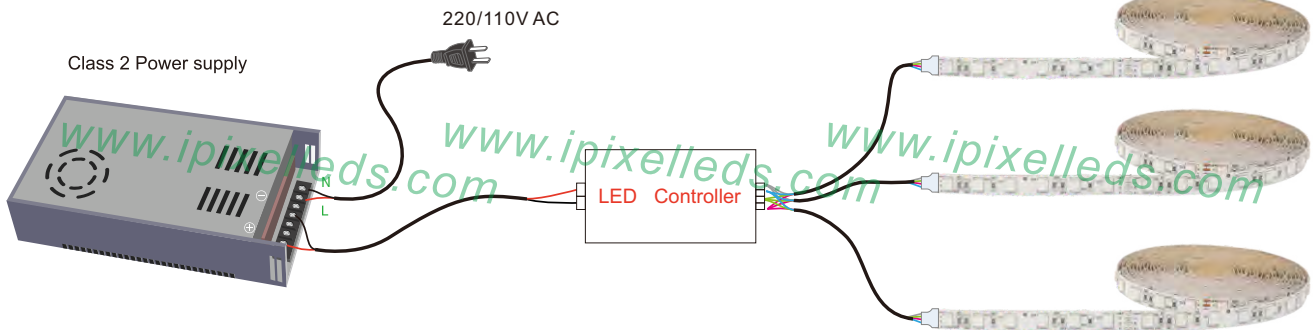

NOTES

1. Please apply different IP rate products according to different environment conditions;
2. Only install with Class 2 power unit
3. Do not install it when power is on. Before powering on, please make sure the wiring is correct;
4. Avoiding damaging the circuit or other component on the strip;
5. Avoid dragging, do not over bending during installation;
6. In order to get the best lighting effect, please do not connect overlong;
7. Please do not stare at the light for long time when it is working to protect your eyes;
8. Installation required by a qualified electrician
9. Supply cable – R/C (AVLV2/8), external use style, rated minimum 300 V, 80 °C, minimum 22 AWG

Product packaging

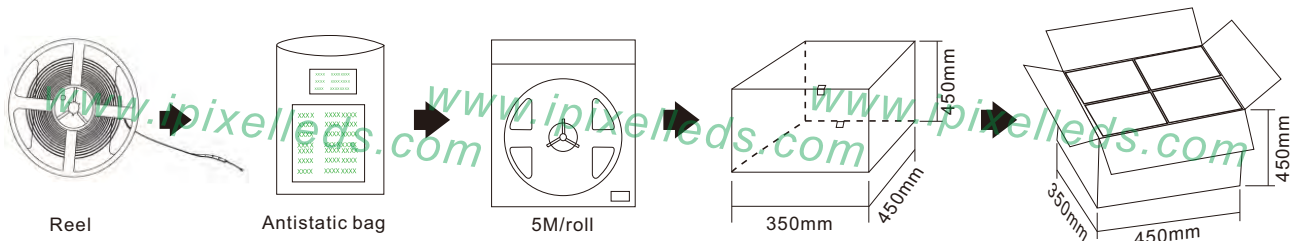

Product number	Standard length	Quantity / volume	outer carton size	Weight(kg)/reel
S005060DA4SA1(IP20)	5M	240 Reels	L450xW350xH450mm	0.13kg
/				/
/				/
/				/
/				/
/				/

X-ON Electronics

Largest Supplier of Electrical and Electronic Components

Click to view similar products for [LED Lighting Bars and Strips](#) category:

Click to view products by [IPIXEL LED](#) manufacturer:

Other Similar products are found below :

[ZLF0310W62524](#) [LF1D-F2F-2W-300](#) [00215258](#) [HH-SWW320F010W12-COB IP20](#) [HH-SWW320F010W24-COB IP20](#) [HH-SWW528F210W12-COB IP65](#) [HH-SG528F010W24-COB IP20](#) [LF2D-EN2F-2W-A](#) [LFBHL-SW827-24V-8S63-20](#) [N006120BC1LZ \(GOLDEN YELLOW\)](#) [S010060CB1LZ \(NEUTRAL WHITE IP65\)](#) [S010060CC1LZ \(WARM WHITE IP65\)](#) [2633830000](#) [HH-SX72F008W24-2835 CW WHITE PCB IP20](#) [HH-SX180F010W24 -2835 WW WHITE PCB IP20](#) [HH-SX72F008W24-2835 NW WHITE PCB IP20](#) [HH-SX144F008W24 -2835 NW WHITE PCB IP20](#) [HH-SX180F010W24 -2835 NW WHITE PCB IP20](#) [HH-SX144F008W24 -2835 CW WHITE PCB IP20](#) [HH-SX144F008W24 -2835 WW WHITE PCB IP20](#) [HH-SX180F010W24 -2835 CW WHITE PCB IP20](#) [N008120BB1LZ \(BLUE\)](#) [00219015](#) [10001611](#) [10001612](#) [10001613](#) [10001617](#) [10001618](#) [10001619](#) [10001622](#) [10001623](#) [10001655](#) [10001657](#) [10001664](#) [10001670](#) [10001675](#) [10001681](#) [10001683](#) [10001690](#) [PUUA-100LLL-NK2P](#) [QAUR1161L030](#) [HC-F12V-3535 PCBA](#) [HC-F12V-F50-3L-WS2811](#) [HC-F12V-WS2811-3535](#) [HC-F5V-144L-144LED-B-WS2813 IP20](#) [HC-F5V-144L-144LED-B-WS2813 IP65](#) [HC-F5V-144L-144LED-W-WS2813 IP20](#) [HC-F5V-30L-30LED-B-WS2813 IP20](#) [HC-F5V-30L-30LED-W-WS2813 IP20](#) [HC-F5V-60L-60LED-B-WS2813 IP20](#)