



Addressable S Shape LED strip



Product Description

This is a flexible-addressable-cuttable-bendable led strip,

There are 60pcs LEDs in a meter and 3 LED in one set

and it's only cuttable 3 leds (65mm length),

The width is 2.5mm on the conner (between 2 LED),



White color painting with a Arrow on each LED

guide the direction of signal,

5mm width PCB ,3M tape attached on backside of flex

and it comes 1m per reel,

But you can connect as many as you can just make sure

feed enough power to it,

We only provide this strip IP20 only



Product Datasheet

Product Number	S008060CA3SA1	S008060CA4SA1
Light Source	SMD 5050 RGB	SMD 5050 RGBW
Beam Angle	120°	
LED Quantity	60 leds/m	
Emitting Color	RGB	RGBW
Luminance(MCD/M)	R: 19200 G: 33600 B: 9120	
Control	SK6812	
Operating Voltage	DC5V	
Power (W)	10W/M (Max)	10W/M (Max)
Size (mm)	L 5000* W 8	
IP	IP 20/IP 65	
Net Weight	0.045kg/roll	
Operation Temperature	- 40 ~ 50 °C	

Application



Hotels ,restaurants, nights clubs, edge light

Recreational machines, playstation



Living rooms, coffee / wine bars, back lighting

TV, dancefloor background, shopping malls,

Strip IP Rate





Curve Lune

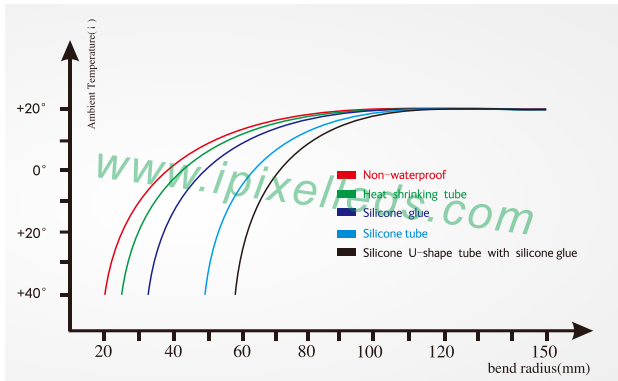
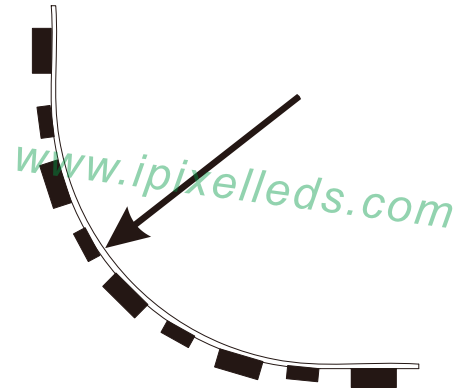
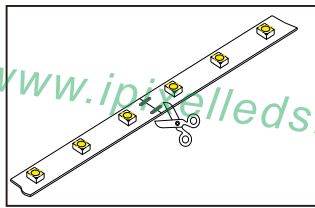

Diagram2: Bend Curve



Installation



Cut in specific location

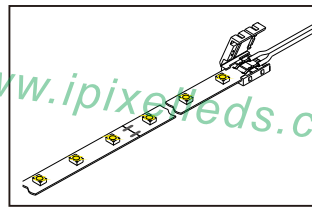

Put the PCB in the space between clip and connector, make the clips exactly aim at welding point

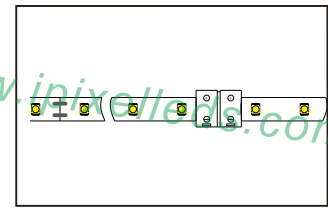

Close the cover of connector

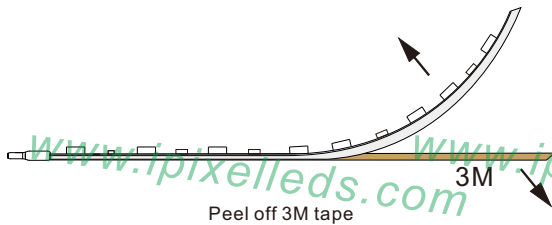

Peel off 3M tape

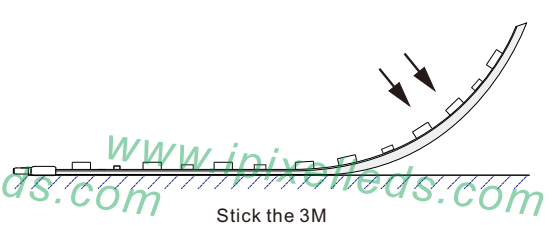

Stick the 3M

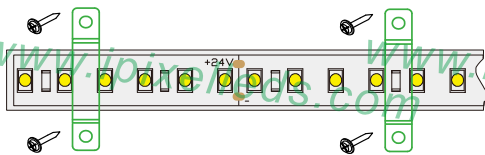

Install with clips

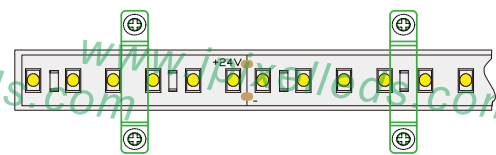

Fix with screws

Accessories (Excluded)



Screws



Silicone clip



End cap



Outline Dimension (unit:mm)

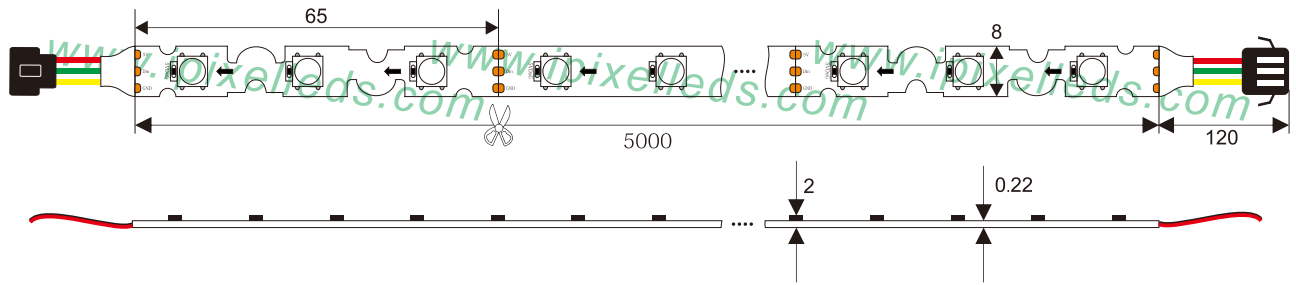

Connection

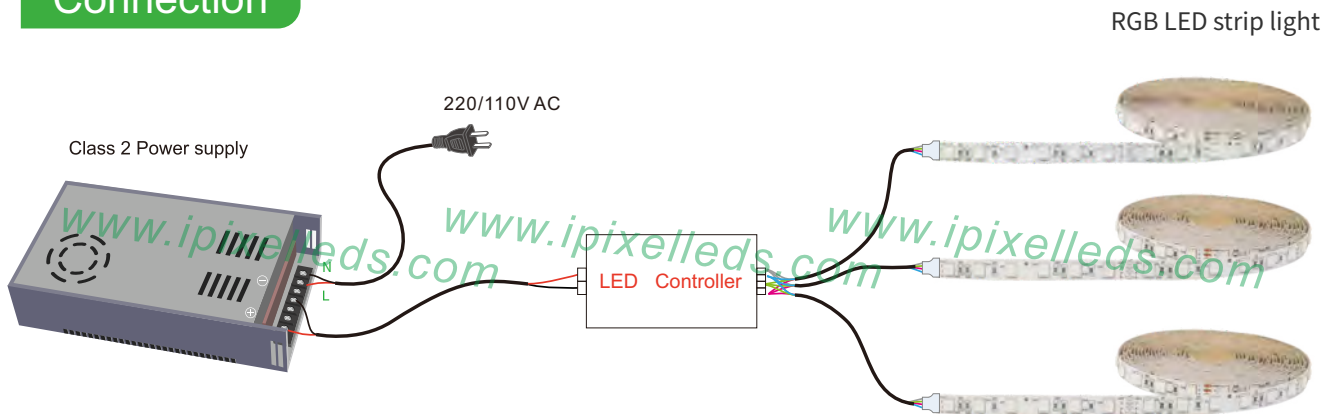

NOTES

1. Please apply different IP rate products according to different environment conditions;
2. Only install with Class 2 power unit
3. Do not install it when power is on. Before powering on, please make sure the wiring is correct;
4. Avoiding damaging the circuit or other component on the strip;
5. Avoid dragging, do not over bending during installation;
6. In order to get the best lighting effect, please do not connect overlong;
7. Please do not stare at the light for a long time when it is working to protect your eyes;
8. Installation required by a qualified electrician
9. Supply cable – R/C (AVLV2/8), external use style, rated minimum 300 V, 80 °C, minimum 22 AWG

Product packaging

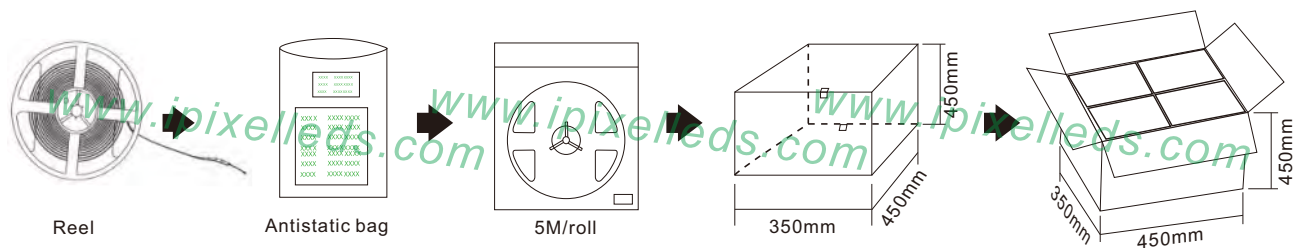

Product number	Standard length	Quantity / volume	outer carton size	Weight(kg)/reel
S004060DA3SA5(IP20)	1M	240 Reels	L450xW350xH450mm	0.13kg
/				/
/				/
/				/
/				/
/				/

X-ON Electronics

Largest Supplier of Electrical and Electronic Components

Click to view similar products for [LED Lighting Bars and Strips](#) category:

Click to view products by [IPIXEL LED](#) manufacturer:

Other Similar products are found below :

[ZLF0310W62524](#) [LF1D-F2F-2W-300](#) [00215258](#) [HH-SWW320F010W12-COB IP20](#) [HH-SWW320F010W24-COB IP20](#) [HH-SWW528F210W12-COB IP65](#) [HH-SG528F010W24-COB IP20](#) [LF2D-EN2F-2W-A](#) [LFBHL-SW827-24V-8S63-20](#) [N006120BC1LZ](#) (GOLDEN YELLOW) [S010060CB1LZ](#) (NEUTRAL WHITE IP65) [S010060CC1LZ](#) (WARM WHITE IP65) [2633830000](#) [HH-SX72F008W24-2835 CW WHITE PCB IP20](#) [HH-SX180F010W24 -2835 WW WHITE PCB IP20](#) [HH-SX72F008W24-2835 NW WHITE PCB IP20](#) [HH-SX144F008W24 -2835 NW WHITE PCB IP20](#) [HH-SX180F010W24 -2835 NW WHITE PCB IP20](#) [HH-SX144F008W24 -2835 CW WHITE PCB IP20](#) [HH-SX144F008W24 -2835 WW WHITE PCB IP20](#) [HH-SX180F010W24 -2835 CW WHITE PCB IP20](#) [N008120BB1LZ](#) (BLUE) [00219015](#) [10001611](#) [10001612](#) [10001613](#) [10001617](#) [10001618](#) [10001619](#) [10001622](#) [10001623](#) [10001655](#) [10001657](#) [10001664](#) [10001670](#) [10001675](#) [10001681](#) [10001683](#) [10001690](#) [PUUA-100LLL-NK2P](#) [QAUR1161L030](#) [HC-F12V-3535 PCBA](#) [HC-F12V-F50-3L-WS2811](#) [HC-F12V-WS2811-3535](#) [HC-F5V-144L-144LED-B-WS2813 IP20](#) [HC-F5V-144L-144LED-B-WS2813 IP65](#) [HC-F5V-144L-144LED-W-WS2813 IP20](#) [HC-F5V-30L-30LED-B-WS2813 IP20](#) [HC-F5V-30L-30LED-W-WS2813 IP20](#) [HC-F5V-60L-60LED-B-WS2813 IP20](#)