



DC5V Standard RGB LED Strip



Product Description

This flexible led strip uses the great LED chip with perfect visual effect. There are 60 SMD5050 per meter. It is energy saving that can keep your project's costs down. It can be cuttable after each 16.66mm, which is convenient for customer's on-site DIY installation.



Using super flexible FPC that can be bent and folded easily.

The led strip passes the UL2108 engineering laboratory assessment with the design of copper foil inside the FPC

With adhesive tape on the back side that can be tear off and stuck easily.



Product Datasheet

Product Number	S010060CA3PZ
Light Source	5050 RGB
Beam Angle	120°
LED Quantity	60leds/m
Wavelength	R:620nm G:520nm B:467nm
Lumens/M	R:34LM G:124LM B:27LM
Cutting unit	16.66 MM
Operating Voltage	DC5V
Power (W)	12W/M
Size (mm)	L 5000* W 10
IP	IP 20/IP 64/IP 65
Net Weight	0.24kg/roll
Operation Temperature	- 40 ~ 50 °C

Application



Hotels, restaurants, nights clubs.

Advertising signs, brightening.



Back lighting, edge lighting.

Dancefloor background.

Strip IP Rate





Curve Lune

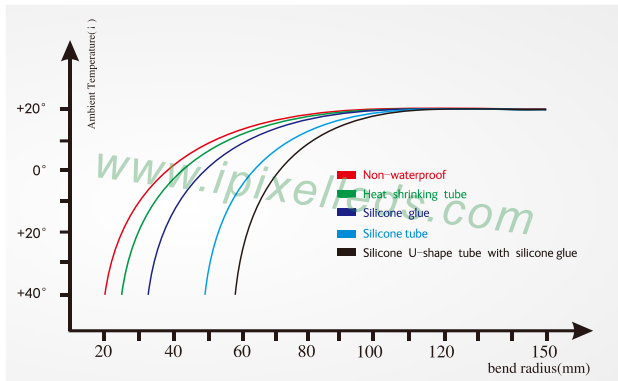
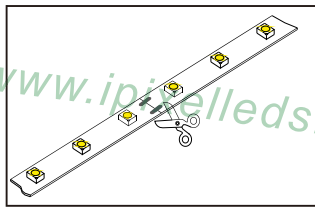

Diagram2: Bend Curve



Installation



Cut in specific location

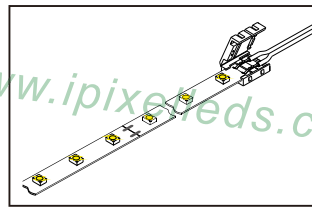

Put the PCB in the space between clip and connector, make the clips exactly aim at welding point

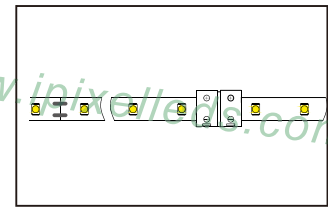

Close the cover of connector

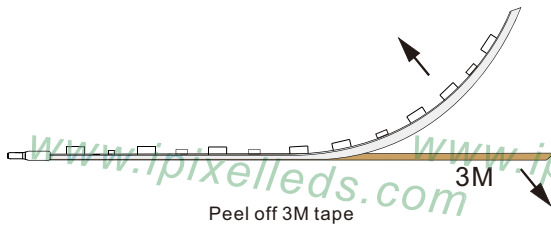

Peel off 3M tape

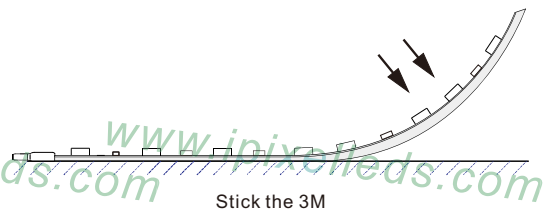

Stick the 3M

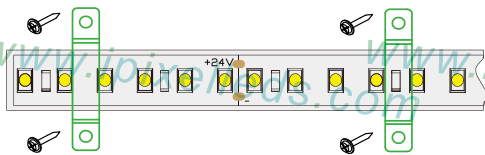

Install with clips

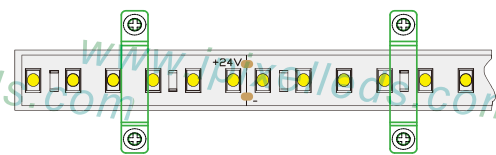

Fix with screws

Accessories (Excluded)



Screws



Silicone clip



Dc male and female connector



End cap



Outline Dimension (unit:mm)

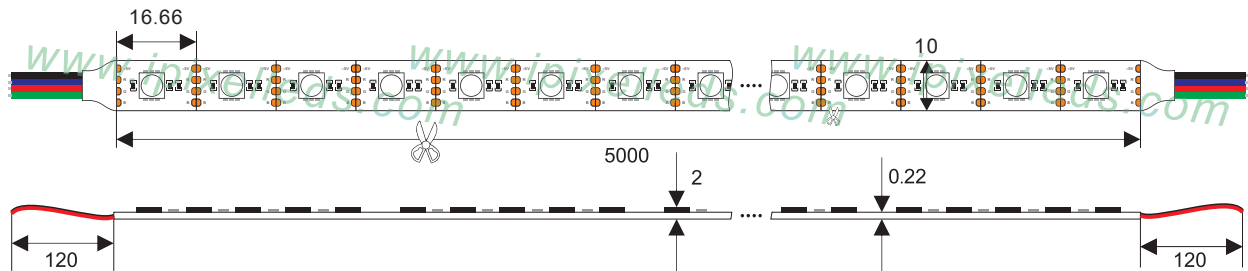

Connection

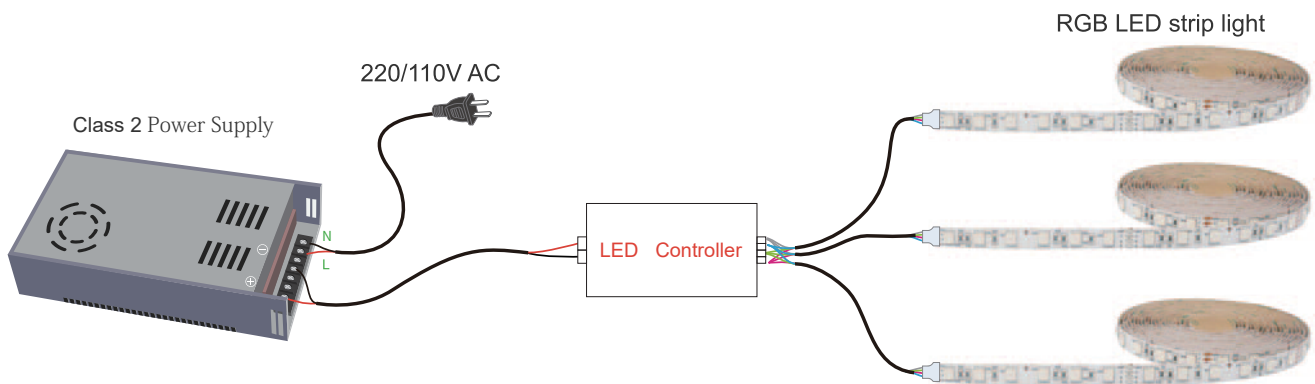

NOTES

1. Please apply different IP rate products according to different environment conditions;
2. Only install with Class 2 power unit
3. Do not install it when power is on. Before powering on, please make sure the wiring is correct;
4. Avoiding damaging the circuit or other component on the strip;
5. Avoid dragging, do not over bending during installation;
6. In order to get the best lighting effect, please do not connect overlong;
7. Please do not stare at the light for along time when it is working to protect your eyes;
8. Installation required by a qualified electrician
9. Supply cable – R/C (AVLV2/8), external use style, rated minimum 300 V, 80 °C, minimum 22 AWG

X-ON Electronics

Largest Supplier of Electrical and Electronic Components

Click to view similar products for [LED Lighting Bars and Strips](#) category:

Click to view products by [IPIXEL LED](#) manufacturer:

Other Similar products are found below :

[ZLF0310W62524](#) [LF1D-F2F-2W-300](#) [00215258](#) [HH-SWW320F010W12-COB IP20](#) [HH-SWW320F010W24-COB IP20](#) [HH-SWW528F210W12-COB IP65](#) [HH-SG528F010W24-COB IP20](#) [LF2D-EN2F-2W-A](#) [10001622](#) [LFBHL-SW827-24V-8S63-20](#) [LFBHL-SW860-24V-8S63-20](#) [LFBHL-SW940-24V-8S63-20](#) [HH-SRGB60F010W24-5050M](#) [N006120BB1LZ \(BLUE\)](#) [N006120BB1LZ \(GREEN\)](#) [N006120BB1LZ \(RED\)](#) [N006120BC1LZ \(BLUE\)](#) [N006120BC1LZ \(GREEN\)](#) [N006120BC1LZ \(GOLDEN YELLOW\)](#) [N006120BC1LZ \(RED\)](#) [S010030CB3SB7](#) [S010030CB3SB7 \(BLACK PCB\)](#) [S010060CB1LZ \(NEUTRAL WHITE IP65\)](#) [S010060CB1LZ \(WARM WHITE IP65\)](#) [S010060CB3SB7](#) [S010060CC1LZ \(WARM WHITE IP65\)](#) [S012060CB4ST \(BLACK PCB\)](#) [2633830000](#) [HH-SX72F008W24-2835 CW WHITE PCB IP20](#) [HH-SX180F010W24 -2835 WW WHITE PCB IP20](#) [HH-SX72F008W24-2835 NW WHITE PCB IP20](#) [HH-SX144F008W24 -2835 NW WHITE PCB IP20](#) [HH-SX180F010W24 -2835 NW WHITE PCB IP20](#) [HH-SX144F008W24 -2835 CW WHITE PCB IP20](#) [HH-SX144F008W24 -2835 WW WHITE PCB IP20](#) [HH-SX180F010W24 -2835 CW WHITE PCB IP20](#) [N008120BB1LZ \(BLUE\)](#) [S010060CA3SA1](#) [SCS-120-CW](#) [00219015](#) [10001611](#) [10001612](#) [10001613](#) [10001617](#) [10001618](#) [10001619](#) [10001623](#) [10001655](#) [10001657](#) [10001664](#)