

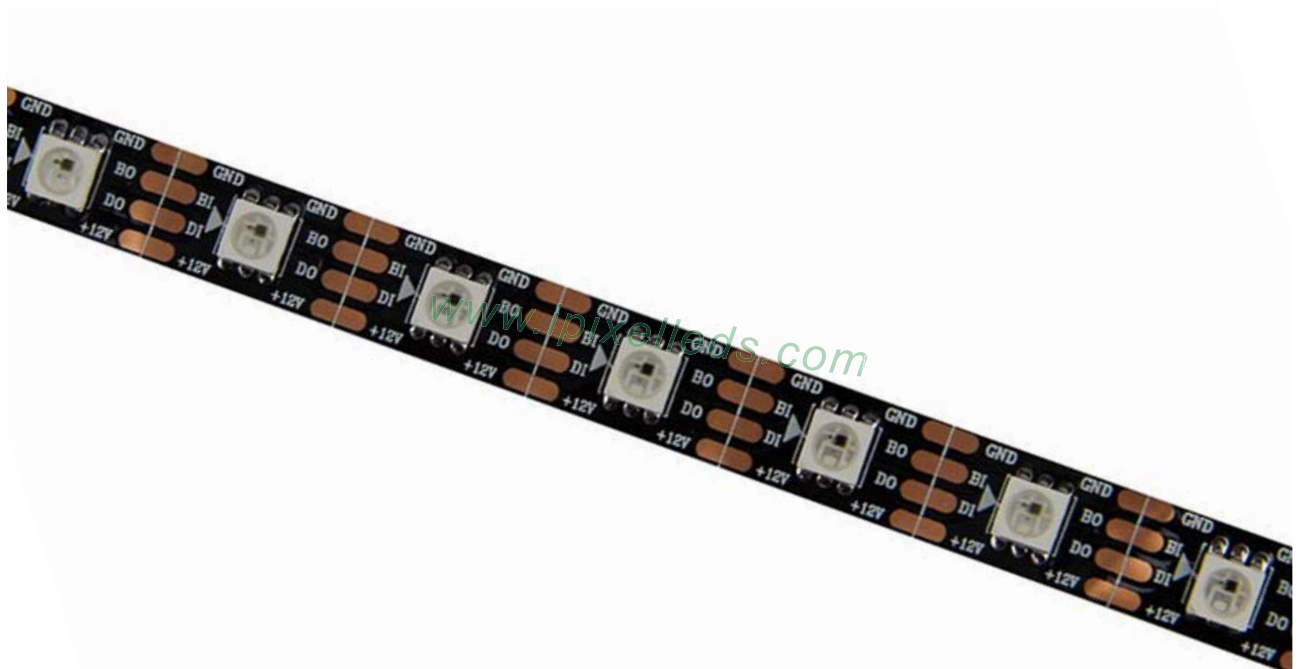

60Pixel 12V Addressable LED Strip



Product Description

This is a new chip again from worldsemi family , based on WS2812B and WS2813.

To solve the chip breakdown and Strip's Voltage drop , now we welcome WS2815.

The Flex is 60 Pixel/ LED per meter ,and 5 m in a roll we provide black and white color board.

same as our other addressable tapes, it's cut-able per unit LED with a large soldering Pad which makes easy to re-solder again.



the PCB printed +12V DI ,BI, GND , both DI and BI means signal but it's only required to link the DI cable to your controller.

this PCB made by 3Ounce copper for more reliable application.

3 M tape attached on backside of strip.

again we suggested you power it every 5 meters even it's 12V addressable.



Product Datasheet

Product Number	S010060CB3SB7
Light Source	WS 2815 RGB
Beam Angle	120°
LED Quantity	60 leds/m
Emitting Color	Full color
Wavelength	R:635nm G:510nm B:470nm
PCB color	White/Black
Operating Voltage	DC12V
Power (W)	12W/M (Max)
Size (mm)	L 5000* W 10
IP	IP 20/IP 65
Net Weight	0.13kg/roll
Operation Temperature	- 40 ~ 50 °C

Application



Hotels ,restaurants, nights clubs, edge light

Recreational machines, playstation



Living rooms, coffee / wine bars, back lighting

TV, dancefloor background, shopping malls,

Strip IP Rate





Curve Lune

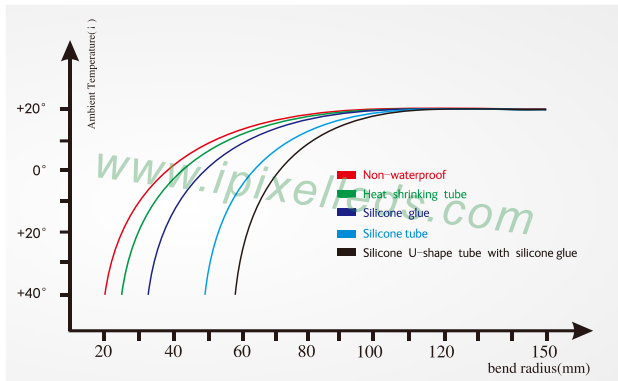
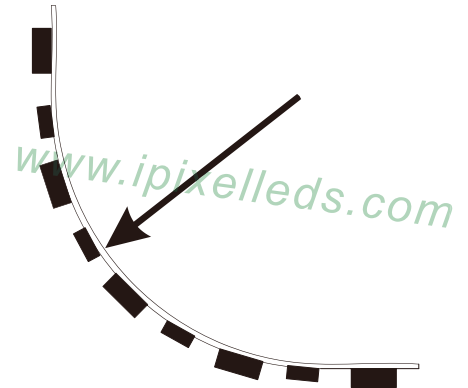
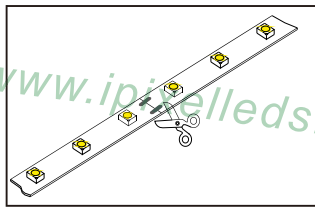

Diagram2: Bend Curve



Installation



Cut in specific location

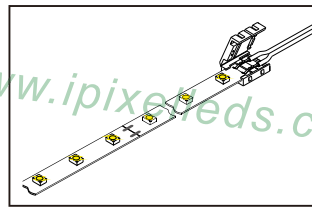

Put the PCB in the space between clip and connector, make the clips exactly aim at welding point

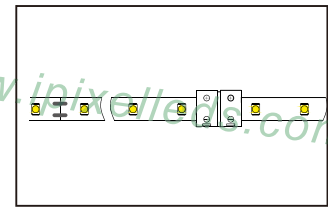

Close the cover of connector

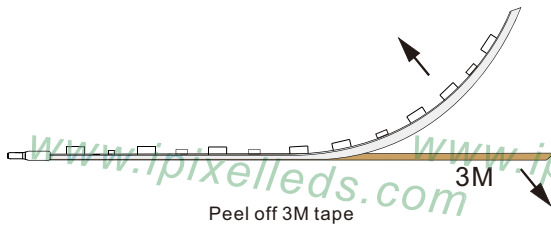

Peel off 3M tape

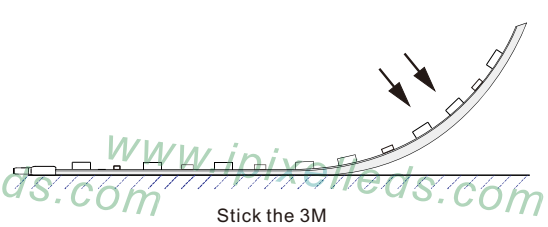

Stick the 3M

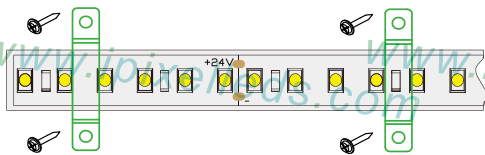

Install with clips

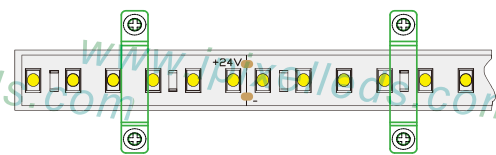

Fix with screws

Accessories (Excluded)



Screws



Silicone clip



End cap



Outline Dimension (unit:mm)

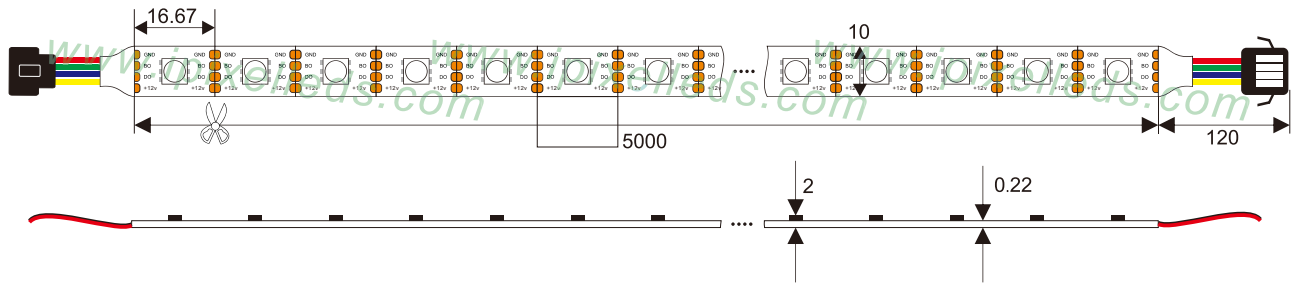

Connection

RGB LED strip light

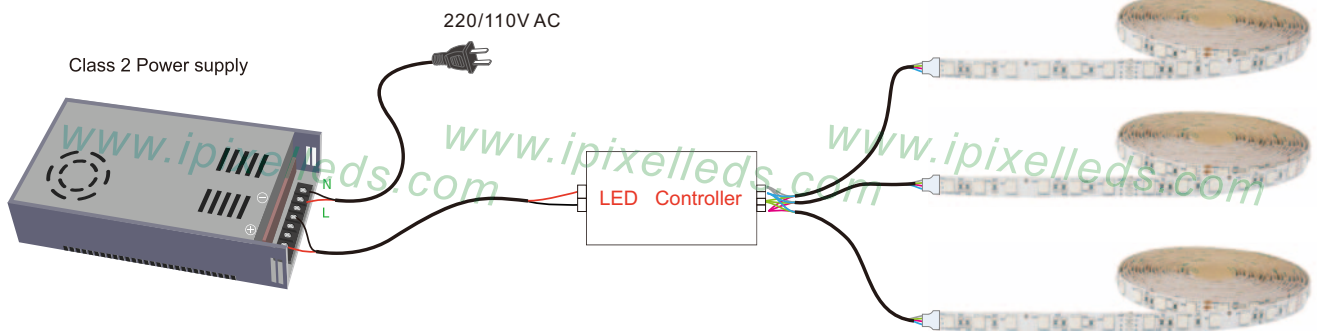

NOTES

1. Please apply different IP rate products according to different environment conditions;
2. Only install with Class 2 power unit
3. Do not install it when power is on. Before powering on, please make sure the wiring is correct;
4. Avoiding damaging the circuit or other component on the strip;
5. Avoid dragging, do not over bending during installation;
6. In order to get the best lighting effect, please do not connect overlong;
7. Please do not stare at the light for along time when it is working to protect your eyes;
8. Installation required by a qualified electrician
9. Supply cable – R/C (AVLV2/8), external use style, rated minimum 300 V, 80 °C, minimum 22 AWG

Product packaging

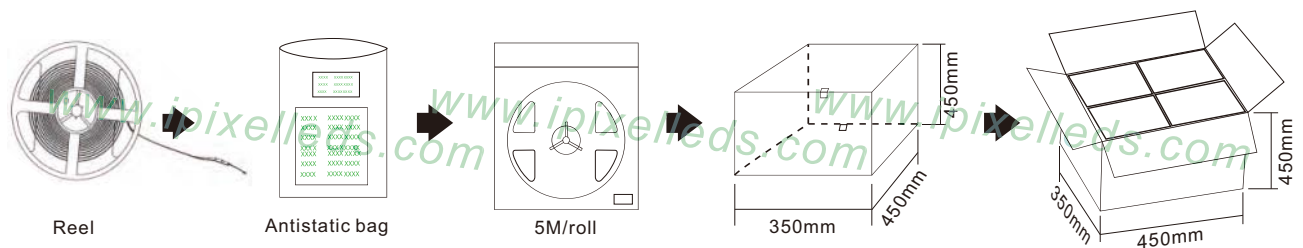

Product number	Standard length	Quantity / volume	outer carton size	Weight(kg)/reel
S010060CB3SB7(IP20)	5M	240 Reels	L450xW350xH450mm	0.13kg
/				/
/				/
/				/
/				/
/				/

X-ON Electronics

Largest Supplier of Electrical and Electronic Components

Click to view similar products for [LED Lighting Bars and Strips](#) category:

Click to view products by [IPIXEL LED](#) manufacturer:

Other Similar products are found below :

[ZLF0310W62524](#) [LF1D-F2F-2W-300](#) [00215258](#) [HH-SWW320F010W12-COB IP20](#) [HH-SWW320F010W24-COB IP20](#) [HH-SWW528F210W12-COB IP65](#) [HH-SG528F010W24-COB IP20](#) [LF2D-EN2F-2W-A](#) [10001622](#) [LFBHL-SW827-24V-8S63-20](#) [LFBHL-SW860-24V-8S63-20](#) [LFBHL-SW940-24V-8S63-20](#) [HH-SRGB60F010W24-5050M](#) [N006120BB1LZ \(BLUE\)](#) [N006120BB1LZ \(GREEN\)](#) [N006120BB1LZ \(RED\)](#) [N006120BC1LZ \(BLUE\)](#) [N006120BC1LZ \(GREEN\)](#) [N006120BC1LZ \(GOLDEN YELLOW\)](#) [N006120BC1LZ \(RED\)](#) [S010030CB3SB7](#) [S010030CB3SB7 \(BLACK PCB\)](#) [S010060CB1LZ \(NEUTRAL WHITE IP65\)](#) [S010060CB1LZ \(WARM WHITE IP65\)](#) [S010060CB3SB7](#) [S010060CC1LZ \(WARM WHITE IP65\)](#) [S012060CB4ST \(BLACK PCB\)](#) [2633830000](#) [HH-SX72F008W24-2835 CW WHITE PCB IP20](#) [HH-SX180F010W24 -2835 WW WHITE PCB IP20](#) [HH-SX72F008W24-2835 NW WHITE PCB IP20](#) [HH-SX144F008W24 -2835 NW WHITE PCB IP20](#) [HH-SX180F010W24 -2835 NW WHITE PCB IP20](#) [HH-SX144F008W24 -2835 CW WHITE PCB IP20](#) [HH-SX144F008W24 -2835 WW WHITE PCB IP20](#) [HH-SX180F010W24 -2835 CW WHITE PCB IP20](#) [N008120BB1LZ \(BLUE\)](#) [S010060CA3SA1](#) [SCS-120-CW](#) [00219015](#) [10001611](#) [10001612](#) [10001613](#) [10001617](#) [10001618](#) [10001619](#) [10001623](#) [10001655](#) [10001657](#) [10001664](#)