



## Addressable APA102 LED Strip-60leds



### Product Description

Addressable LED Strip has 60pcs SMD5050 RGB Built

in IC Chips

Each single LED per unit and cut-able every 16.67mm

The PCB is 1+2 Ounce copper, PCB wide is 12mm



All the soldering Pads are very large, with +/-, DAT

and CLK White & Black PCB, DC5V voltage

5 Meters per reel, Customized sizes are also available

4Pin JST SM connector, IP65 waterproof by silicon

tube housing



## Product Datasheet

Product Number	S012060CA3SA2
Light Source	SMD 5050 RGB
Beam Angle	120°
LED Quantity	60 leds/m
Emitting Color	Full color
Luminance Per 1m	R:24000 G:42000 B:11400
Control	APA102/SK9822
Operating Voltage	DC5V
Power (W)	14 W/M (Max)
Size (mm)	L 5000* W 12
IP	IP 20/IP 65
Net Weight	0.13kg/roll
Operation Temperature	- 40 ~ 50 °C

## Application



Hotels ,restaurants, nights clubs, edge light

Recreational machines, playstation

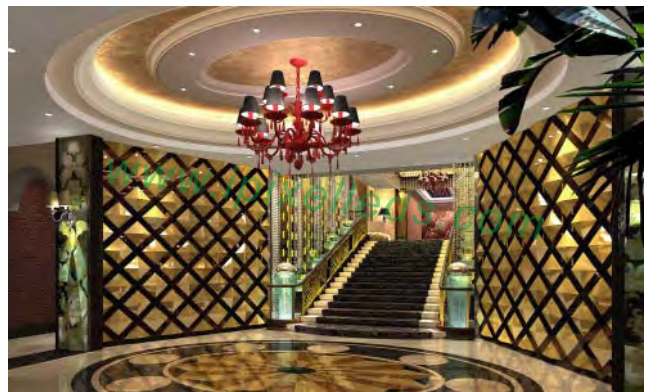

Living rooms, coffee / wine bars, back lighting

TV, dancefloor background, shopping malls,

## Strip IP Rate





## Curve Lune

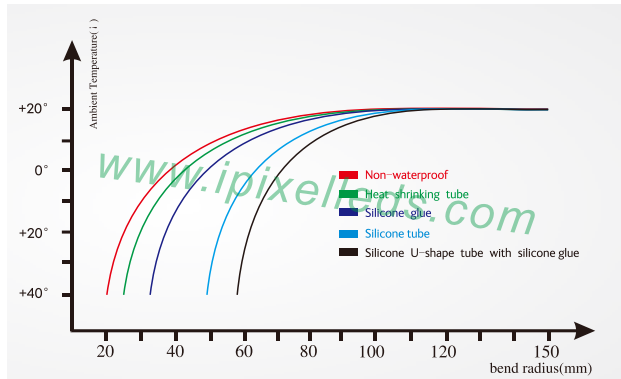
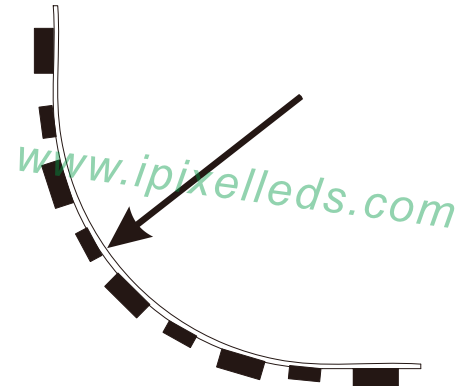
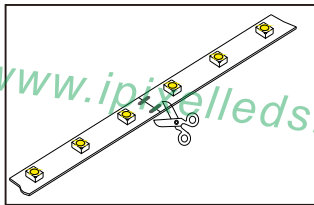

Diagram2: Bend Curve



## Installation



Cut in specific location

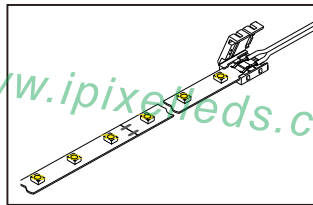

Put the PCB in the space between clip and connector, make the clips exactly aim at welding point

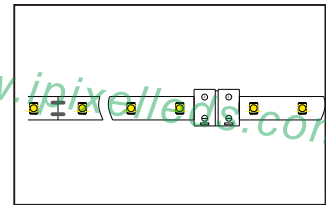

Close the cover of connector

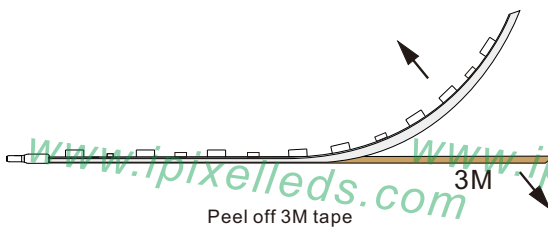

Peel off 3M tape

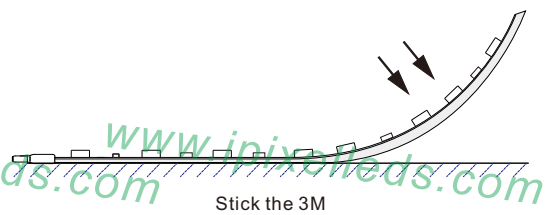

Stick the 3M

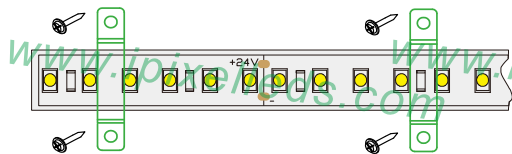

Install with clips

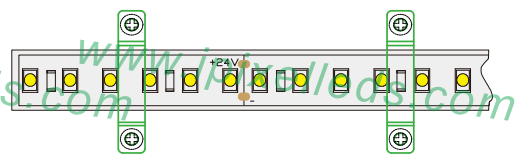

Fix with screws

## Accessories (Excluded)



Screws



Silicone clip



End cap



## Outline Dimension (unit:mm)

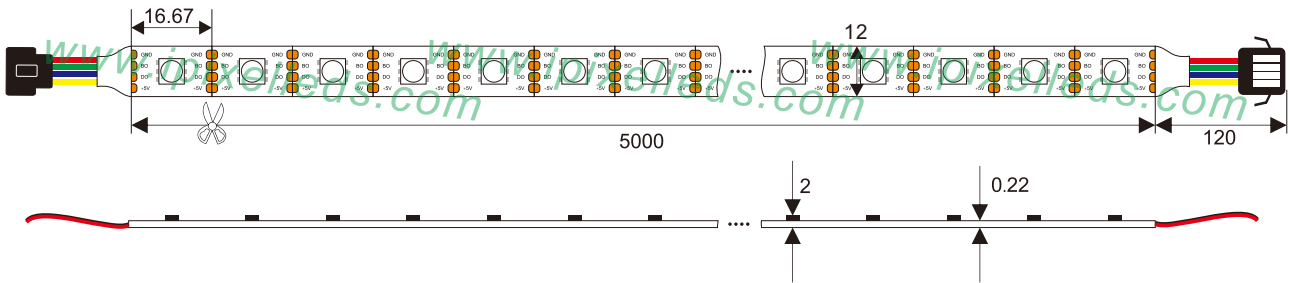

## Connection

RGB LED strip light

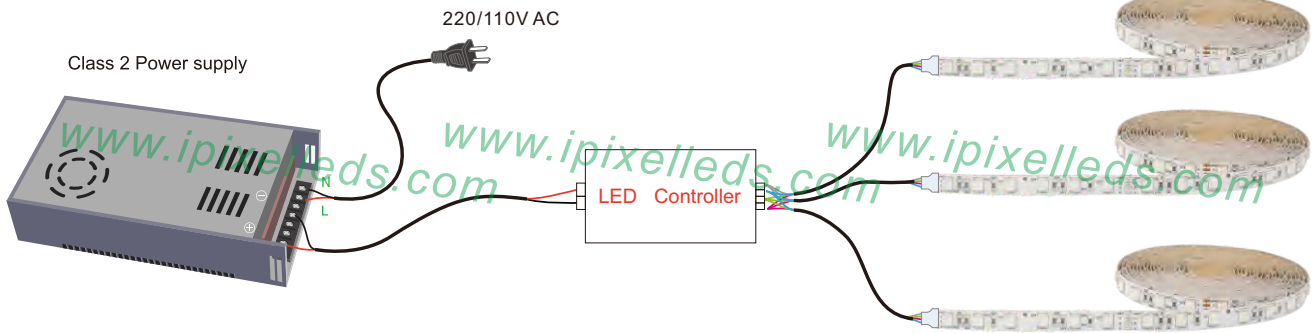

### NOTES

1. Please apply different IP rate products according to different environment conditions;
2. Only install with Class 2 power unit
3. Do not install it when power is on. Before powering on, please make sure the wiring is correct;
4. Avoiding damaging the circuit or other component on the strip;
5. Avoid dragging, do not over bending during installation;
6. In order to get the best lighting effect, please do not connect overlong;
7. Please do not stare at the light for long time when it is working to protect your eyes;
8. Installation required by a qualified electrician
9. Supply cable – R/C (AVLV2/8), external use style, rated minimum 300 V, 80 °C, minimum 22 AWG

## Product packaging

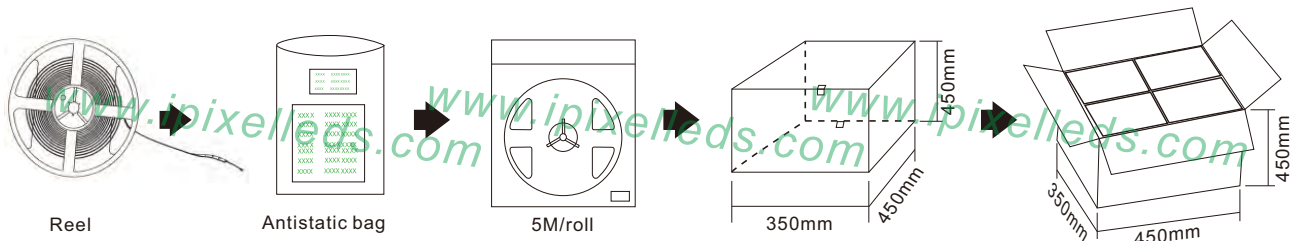

Product number	Standard length	Quantity / volume	outer carton size	Weight(kg)/reel
S012060CA3SA2(IP20)	5M	240 Reels	L450xW350xH450mm	0.13kg
/				/
/				/
/				/
/				/
/				/

## X-ON Electronics

Largest Supplier of Electrical and Electronic Components

*Click to view similar products for [LED Lighting Bars and Strips](#) category:*

*Click to view products by [IPIXEL LED](#) manufacturer:*

Other Similar products are found below :

[ZLF0310W62524](#) [LF1D-F2F-2W-300](#) [00215258](#) [HH-SWW320F010W12-COB IP20](#) [HH-SWW320F010W24-COB IP20](#) [HH-SWW528F210W12-COB IP65](#) [HH-SG528F010W24-COB IP20](#) [LF2D-EN2F-2W-A](#) [LFBHL-SW827-24V-8S63-20](#) [N006120BC1LZ \(GOLDEN YELLOW\)](#) [S010060CB1LZ \(NEUTRAL WHITE IP65\)](#) [S010060CC1LZ \(WARM WHITE IP65\)](#) [2633830000](#) [HH-SX72F008W24-2835 CW WHITE PCB IP20](#) [HH-SX180F010W24 -2835 WW WHITE PCB IP20](#) [HH-SX72F008W24-2835 NW WHITE PCB IP20](#) [HH-SX144F008W24 -2835 NW WHITE PCB IP20](#) [HH-SX180F010W24 -2835 NW WHITE PCB IP20](#) [HH-SX144F008W24 -2835 CW WHITE PCB IP20](#) [HH-SX144F008W24 -2835 WW WHITE PCB IP20](#) [HH-SX180F010W24 -2835 CW WHITE PCB IP20](#) [N008120BB1LZ \(BLUE\)](#) [00219015](#) [10001611](#) [10001612](#) [10001613](#) [10001617](#) [10001618](#) [10001619](#) [10001622](#) [10001623](#) [10001655](#) [10001657](#) [10001664](#) [10001670](#) [10001675](#) [10001681](#) [10001683](#) [10001690](#) [PUUA-100LLL-NK2P](#) [QAUR1161L030](#) [HC-F12V-3535 PCBA](#) [HC-F12V-F50-3L-WS2811](#) [HC-F12V-WS2811-3535](#) [HC-F5V-144L-144LED-B-WS2813 IP20](#) [HC-F5V-144L-144LED-B-WS2813 IP65](#) [HC-F5V-144L-144LED-W-WS2813 IP20](#) [HC-F5V-30L-30LED-B-WS2813 IP20](#) [HC-F5V-30L-30LED-W-WS2813 IP20](#) [HC-F5V-60L-60LED-B-WS2813 IP20](#)