

Customer Part:

Description

- 1.2V low voltage oscillator in a hermetically sealed 3.2 x 2.5mm surface mount ceramic package.
- Model IQXO-691 3225-12
- Model Issue number 3

Frequency Parameters

- Frequency 24.0MHz
- Frequency Stability $\pm 50.00\text{ppm}$
- Operating Temperature Range -40.00 to 85.00°C
- Ageing $\pm 3\text{ppm}$ max in 1st year @ 25°C

Electrical Parameters

- Supply Voltage $1.2\text{V} \pm 5\%$
- Current Draw 10.000mA

Output Details

- Output Compatibility CMOS
- Drive Capability 15pF max
- Rise and Fall Time 5.0ns max
- Duty Cycle 45/55%
- Output Voltage Levels:
Output Low (VoL): 10%Vs max
Output High (VoH): 90%Vs min
- Start Up Time: 10ms max

Output Control

- Standby Operation:
Logic '1' ($\geq 70\%$ Vs) to pad 1 enables oscillator output.
Logic '0' ($\leq 30\%$ Vs) to pad 1 disables oscillator output; when disabled the oscillator output goes to the high impedance state.
No connection to pad 1 enables oscillator output (internal pull-up resistor).
- Standby Current: 100 μA max

Noise Parameters

- RMS Phase Jitter (12kHz to 20MHz): 1ps max

Environmental Parameters

- Storage Temperature Range: -55 to 125°C
- Mechanical Shock: MIL-STD-883, Method 2002, Condition B.
- Vibration: MIL-STD-883, Method 2007, Condition A.
- Moisture Resistance: MIL-STD-883, Method 1004.
- Thermal Cycling: MIL-STD-883, Method 1010, Condition B.
- Solderability: MIL-STD-883, Method 2003.
- Resistance to Soldering Heat: MIL-STD-202, Method 210, Condition K.
- Fine Leak Test: MIL-STD-883, Method 1014, Condition A.
- Gross Leak Test: MIL-STD-883, Method 1014, Condition C.

Manufacturing Details

- Note: Please connect a bypass capacitor of 0.1 μF between +Vs and circuit ground.
- RoHS Terminations Au
- RoHS Reflow Temp 260°C max for 10secs max

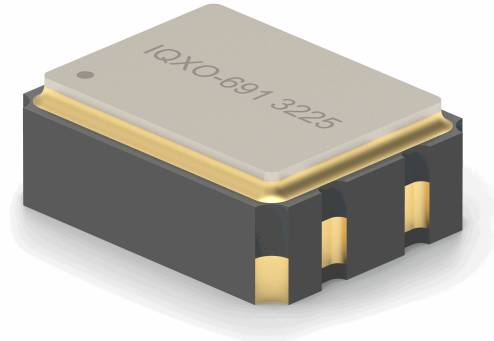
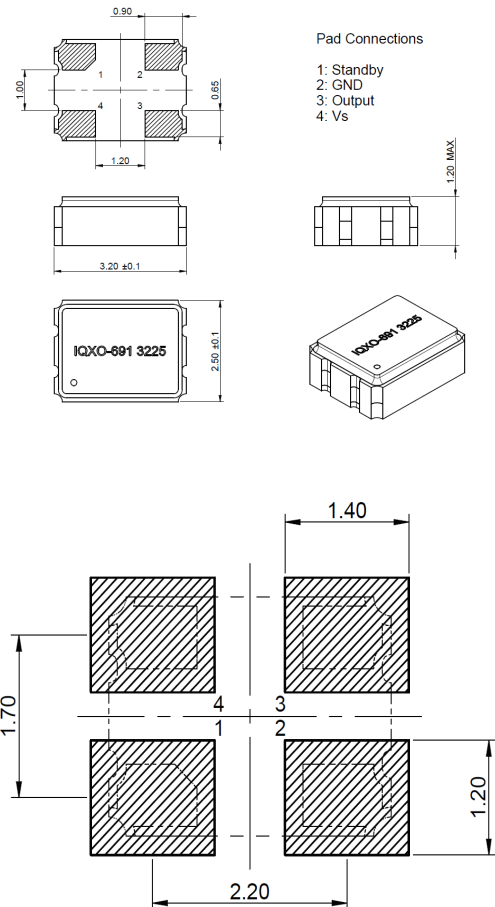
Outline (mm)

Sales Office Contact Details:

UK: +44 (0)1460 270200
Germany: 0800 1808 443

France: 0800 901 383
USA: +1.760.318.2824

Email: info@iqdfrequencyproducts.com
Web: www.iqdfrequencyproducts.com

Customer Part:**Compliance**

- RoHS Status (2015/863/EU) Compliant
- REACH Status Compliant
- MSL Rating (JDEC-STD-033): 1

Packaging Details

- Pack Style: Cutt Cut tape
Pack Size: 100
- *Alternative packing option available*

Sales Office Contact Details:

UK: +44 (0)1460 270200
Germany: 0800 1808 443

France: 0800 901 383
USA: +1.760.318.2824

Email: info@iqdfrequencyproducts.com
Web: www.iqdfrequencyproducts.com

X-ON Electronics

Largest Supplier of Electrical and Electronic Components

Click to view similar products for [Standard Clock Oscillators](#) category:

Click to view products by [IQD](#) manufacturer:

Other Similar products are found below :

[601252](#) [F335-25](#) [F535L-33.333](#) [F535L-50](#) [ECS-2018-160-BN-TR](#) [MXO45HS-2C-66.6666MHZ](#) [SiT1602BI-22-33E-50.000000E](#) [SiT8209AI-32-33E-125.000000](#) [SIT8918AA-11-33S-50.000000G](#) [SM4420TEV-40.0M-T1K](#) [F335-24](#) [F335-40](#) [F535L-10](#) [F535L-12](#) [F535L-16](#) [F535L-24](#) [F535L-27](#) [F535L-48](#) [PE7744DW-100.0M](#) [CSX-750FCC14745600T](#) [ASF1-3.686MHZ-N-K-S](#) [XO57CTECNA3M6864](#) [ECS-2100A-147.4](#) [601251](#) [EP16E7E2H26.000MTR](#) [SIT8918AA-11-33S-16.000000G](#) [XO3003](#) [9120AC-2D2-33E212.500000](#) [9102AI-243N25E100.00000](#) [8208AC-82-18E-25.00000](#) [ASDK2-32.768KHZ-LR-T3](#) [8008AI-72-XXE-24.545454E](#) [8004AC-13-33E-133.33000X](#) [AS-4.9152-16-SMD-TR](#) [ASFL1-48.000MHZ-LC-T](#) [SIT8920AM-31-33E-25.0000](#) [DSC1028DI2-019.2000](#) [9121AC-2C3-25E100.00000](#) [9102AI-233N33E100.00000X](#) [9102AI-233N25E200.00000](#) [9102AI-232H25S125.00000](#) [9102AI-133N25E200.00000](#) [9102AC-283N25E200.00000](#) [9001AC-33-33E1-30.000](#) [3921AI-2CF-33NZ125.000000](#) [5730-1SF](#) [PXA000010](#) [8003AI-12-33S-40.00000Y](#) [1602BI-13-33S-19.200000E](#) [8208AI-2F-18E-25.000000X](#)