

Customer Part:

Description

- Standard 5x3.2mm SMD crystal with four pads.
Ceramic package with a seam sealed metal lid, hermetically sealed.
- Model CFPX-104 iss:9.06
- Model Issue number 9

Frequency Parameters

- Frequency 10.0MHz
- Frequency Tolerance $\pm 30.00\text{ppm}$
- Tolerance Condition @ 25°C
- Frequency Stability $\pm 30.00\text{ppm}$
- Operating Temperature Range -40.00 to 85.00°C
- Overtone Order Fundamental
- Ageing $\pm 3\text{ppm}$ max per year @ 25°C

Electrical Parameters

- Load Capacitance (CL) 12.00pF
- Shunt Capacitance (C0) 7pF max
- Drive Level 100µW max
- ESR 150.00Ω max

Environmental Parameters

- Shock: 1500g, 0.5ms, 3 times in each of 3 mutually perpendicular planes
- Vibration: 20g (20Hz-2000Hz), 1.52mm amplitude, 20mins in 3 mutually perpendicular planes, 4 cycles
- Storage Temperature Range: -55 to 125°C

Manufacturing Details

- RoHS Terminations Au 0.3um~1.0um
- RoHS Reflow Temp 260degC max for 30s max

Compliance

- RoHS Status (2015/863/EU) Compliant
- REACH Status Compliant
- MSL Rating (JDEC-STD-033): Not Applicable

Packaging Details

- Pack Style: Reel Tape & reel in accordance with EIA-481-D
Pack Size: 1,000
- *Alternative packing option available*



Outline (mm)

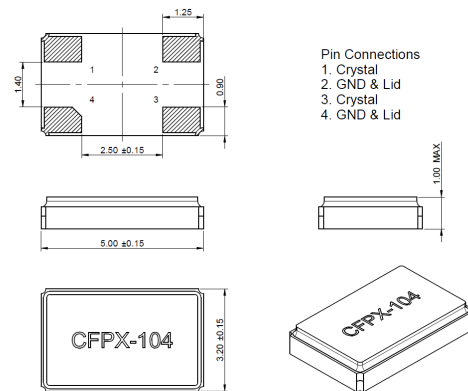

NOTE: The chamfer may appear on pad 1 or 4. This causes no change to the electrical performance of the device.

Recommended Solder Pad Layout

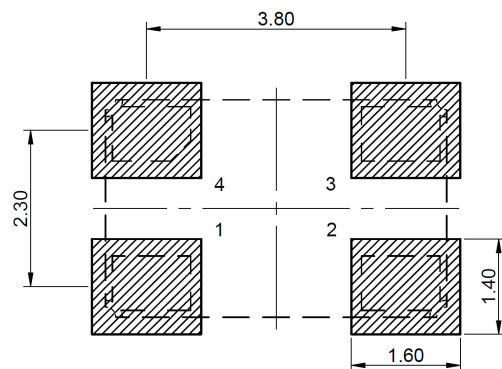

Sales Office Contact Details:

UK: +44 (0)1460 270200
Germany: 0800 1808 443

France: 0800 901 383
USA: +1.760.318.2824

Email: info@iqdfrequencyproducts.com
Web: www.iqdfrequencyproducts.com

X-ON Electronics

Largest Supplier of Electrical and Electronic Components

Click to view similar products for [Crystals](#) category:

Click to view products by [IQD](#) manufacturer:

Other Similar products are found below :

[MC405 32.0000K-R3:PURE SN](#) [7B-27.000MBBK-T](#) [MP1-8.0 99-BU](#) [9B-15.360MBBK-B](#) [PTX-A2JM-10.000M](#) [9C-7.680MBBK-T](#) [H10S-12.000-18-EXT-TR](#) [R38-32.768-12.5-5PPM-NPB](#) [BTD1062E05A-513](#) [21U15A-21.4MHZ](#) [RTX-781DF1-S-20.950](#) [LFXTAL066198Cutt](#) [9C-14.31818MBBK-T](#) [A-11.000MHZ-27](#) [SPT2A-.032768B](#) [SPT2A.032768G](#) [SSPT7F-9PF20-R](#) [FX325BS-38.88EEM1201](#) [MP-1-25.000MHZ-3L](#) [MP-1-6.000MHZ](#) [LFXTAL065253Cutt](#) [LFXTAL066431Cutt](#) [XT9S20ANA14M7456](#) [XT9SNLANA16M](#) [646G-24-2](#) [7A-24.576MBBK-T](#) [7B-30.000MBBK-T](#) [7A-14.31818MBBK-T](#) [6526-202-1501](#) [BTJ120E02C](#) [SG636PCE-20.000MC](#) [3404](#) [CM315D32768EZFT](#) [C1E-24.000-7-2020-R](#) [C1E-19.200-12-1530-X-R](#) [C1E-16.000-12-1530-X-R](#) [ABM11-16.000MHZ-9-B1U-T](#) [FL5000014](#) [EUCA18-3.1872M](#) [425F35E027M0000](#) [17196](#) [ABM3-13.52313MHZ-10-B4Y-T](#) [MS3V-T1R-32.768kHz-7pF-20PPM-TA-QC-Au](#) [VXM7-1C1-16M000](#) [MS1V-T1K-32.768kHz-10pF-20PPM-TA-QC-Au](#) [MS3V-T1R-32.768kHz-9pF-20PPM-TA-QC-Au](#) [ECS-80-18-30-JGN-TR](#) [17000](#) [17301](#)