



254

Quick Clamps



PRODUCT DETAILS

- Professional F-clamp
- Ratcheting system for easy adjustment and clamping
- Length 300 to 600 mm
- High clamping capacity, up to 510 kg
- Capacity 200 to 600 mm
- Steel guide, body and jaws
- Aluminium handle with plastic trigger
- Non-slip braking mechanism
- Fix top pad and swivel bottom pad.
- Retail packaging with tag for relevant information

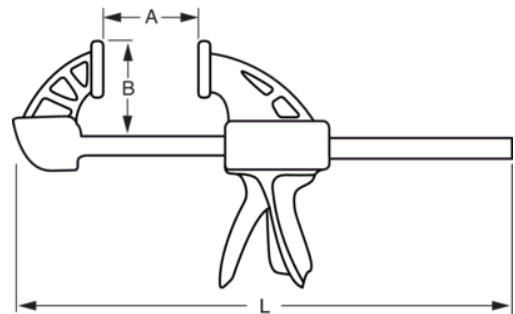

PRODUCT ATTRIBUTES

Product	L	A	B	
254-150-2	335 mm	150 mm	60 mm	487 g
254-300-2	485 mm	300 mm	60 mm	586 g
254-450-2	635 mm	450 mm	60 mm	686 g
254-600-2	785 mm	600 mm	60 mm	781 g
254-900-2	1085 mm	900 mm	60 mm	980 g
254-1200-2	1385 mm	1200 mm	60 mm	1165 g

X-ON Electronics

Largest Supplier of Electrical and Electronic Components

Click to view similar products for [Other Tools](#) category:

Click to view products by [IRIMO](#) manufacturer:

Other Similar products are found below :

[899-2-KT46](#) [CR-0AFL4--332K](#) [568681-1](#) [5800-0090](#) [58061-1](#) [59085](#) [00-8273-RDPP](#) [593033](#) [593072](#) [593564100](#) [593575](#) [593593](#) [010-0003-0000](#) [011349-000](#) [CRCW08052740FRT1](#) [LUC-012S070DSM](#) [LUC-018S070DSP](#) [LUC-024S105DSP](#) [599-2021-3-NME](#) [599-JJ-2021-03](#) [CRCW2010331JR02](#) [601-JJ-06](#) [601-SPB](#) [601YSY](#) [602-JJ-03](#) [602SPB](#) [603-JJ-07-FP](#) [603-JJY-04](#) [CRTN1013](#) [CS16](#) [6-1579014-0](#) [62036240-1](#) [M43435 TY 1 SZ 3 FIN B BLK](#) [M43435 TY 2 SZ 3 FIN C BLK](#) [M43435 TY 5 SZ 3 FIN C NAT](#) [M-5Z](#) [M6816](#) [660-29ABT1](#) [662508-1](#) [CVHD-950X-93.333](#) [CW104-01X](#) [671-GP-04-KT39-73207](#) [CW307-01A](#) [CW30901A](#) [CW6211201A](#) [690191-1](#) [690191-3](#) [690317-2](#) [691409-4](#)