

IRWIN®

CATALOGUE 2019



WISE-GRIP®

JACK

QUICK-GRIP®

Record®

Marples®

joran®

www.irwin.eu

INNOVATION MILESTONES

1885

Patent of IRWIN® Auger Charles Irwin formed the IRWIN® Auger Bit Co



1828

MARPLES® Chisels

1890

Solid Center Auger



1914

HANSON® Taps & Dies



1924

WISE-GRIP® Locking Pliers



1954

SPEEDBOR® Wood Boring Spade Bits



1972

UNIBIT® Step Drill Bits



2004

Bi-Metal Blades



2006

Blue Groove 6X Wood Boring Bits



2009

QUICK-GRIP® Bar Clamps



2011

WISE-GRIP® GrooveLock Water Pump Pliers



2012

WISE-GRIP® Fast Release MARPLES® Chisels



2014

JACK® Plus Handsaw Range



MARPLES® & WELDTEC Circular Saw Blades



2015

IMPACT Screwdriving Bits VISE-GRIP® Performance Pliers



2016

RECORD® Quick-Adjusting Vice



2017

Multi-bit Drivers & Soft-Sided Tool Storage



2019

WISE-GRIP® Reduced Hand Span Locking Pliers



THE HISTORY OF IRWIN TOOLS

IRWIN Tools has a long and storied history, stretching for more than a century and set against the backdrop of a young, ambitious nation. In 1885, Charles Irwin patented the Auger bit and, along with four business partners, formed the IRWIN Auger Bit Company. In 1924, William Petersen, a Danish immigrant, invented and patented VISE-GRIP® Locking Pliers. Through innovation and a series of acquisitions, these two companies have now become IRWIN Tools.

IRWIN Tools manufactures and distributes a broad line of hand tools and power tool accessories including JACK® handsaws, RECORD® clamping and locking tools, VISE-GRIP® pliers and wrenches, JORAN® drill bits, QUICK-GRIP® clamping tools, MARPLES® chisels and woodworking tools, and UNIBIT® drill bits.



IRWIN® innovation

Innovation is the hallmark of IRWIN®. For more than 100 years, it's been an idea that has permeated the culture of our company, and it continues to drive everything we do. Beginning in 1885 with development of the first IRWIN® auger bit, and progressing with the introduction of Vise-Grip® locking tools, Blue Groove flat bits, and Quick-Grip® bar clamps, IRWIN® has been at the forefront of the industry, creating better tools in a better way. Our impressive track record of new product development is born from our passion for understanding the needs of our primary user – the professional tradesman. This dedication to improving products begins in the field, where IRWIN®'s specialised end-user teams visit construction sites. There, the IRWIN® Field Product Specialist team learns first-hand – from the professional – how to improve our products, and how to make the pro's job easier and more productive. This hard-earned knowledge is the foundation for a unique product development process utilised by IRWIN®'s engineering, marketing, and manufacturing teams to deliver a continuous stream of new products to the marketplace. Supported by a global network of world-class manufacturing facilities and bolstered by our partnerships with leading global retailers, IRWIN® continuously sets the professional standard in each and every market segment in which we compete. From product feedback and development to distribution and use in the field, we dedicate ourselves to delivering quality tools that meet the stringent requirements of our toughest critics – professional tradesmen.



IRWIN® DESIGN CENTRES

IRWIN® has been delivering high-quality and innovative products for over a century. The experience and knowledge to design and build the IRWIN® products with rigorous testing and quality control are fundamental parts in our ability to offer the best products. Our testing centre facilities across the globe ensure exactly that. The centres below use the very latest technology and testing methods within their specific areas of expertise.



IRWIN® new products for 2019

**WISE-GRIP® LOCKING PLIERS
WITH REDUCED HAND SPAN**



SPEEDHAMMER™ QUAD



SPEEDHAMMER™ MAX











**WOOD, METAL, MASONRY
AND SCREWDRIVING SETS**











CONTENTS

HAND TOOLS

04 Pliers & Wrenches 	23 Metal Cutting 	31 Woodworking 	43 Workholding 	62 Screwdrivers Multi-Bit Tools & Hex Keys 
74 Utility Knives & Blades 	82 Layout Tools 	88 Tool Storage & Workwear 	98 Plumbing Tools 	

POWER TOOL ACCESSORIES

102 Masonry Drilling 	119 Metal Drilling 	132 Wood Drilling 	141 Fastener Drives & Screwdriving 	156 Circular Saw Blades 
166 Bi-Metal Hole Saws 	170 Reciprocating Saw Blades 	174 Jigsaw Blades 	176 Index 	



WISE-GRIP®

The Vise-Grip® Locking Tool was invented in 1924 by a blacksmith in a small town of DeWitt, Nebraska. William Petersen was a Danish immigrant who invented the first locking pliers in his blacksmith shop, and began selling them from the back of his car to farmers and people in surrounding towns. He patented his new idea and called it VISE-GRIP®.

Since then, VISE-GRIP® has gained global brand recognition as the first choice for locking pliers. Innovation and quality are the core values of the VISE-GRIP® brand. With proven performance in every turn, these are the tools that tradespeople choose first – and pass on to the next generation.

The IRWIN® VISE-GRIP® family offers a full line of locking pliers, water pump pliers, cutting and VDE Pliers. IRWIN® VISE-GRIP® pliers and wrenches continue to set the standard for dependability, quality, and innovation today and tomorrow. Wherever there's a need for a quality tool, IRWIN® VISE-GRIP® is on the job.



Record®

Originally established in 1898 in the South Yorkshire city of Sheffield in the UK, the Record Tools Factory was swiftly able to make a long lasting contribution to the worldwide reputation of the region for the manufacture of high quality steel and castings.

The Record® brand name was introduced in 1909 and by the 1920's the product range had expanded into vices, planes, clamps and pipe wrenches enabling the business to grow rapidly in the UK and many overseas markets.

Today, IRWIN® Record® continues excelling by sticking to the traditional values set by its founders, producing tools that are highly valued amongst professional users for quality and durability that remains strong today.



LOCKING TOOLS



PLIERS



WRENCHES



WISE-GRIP®

LOCKING PLIERS

NEW

The Original

Since 1924™

IRWIN® VISE-GRIP® Original locking tools, with a classic guarded trigger release, are designed to provide maximum locking force.

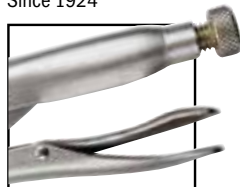

Fast Release

IRWIN® VISE-GRIP® Fast Release locking pliers have a one-handed, triggerless release, so they're twice as easy to open as the traditional design. No pinch points.

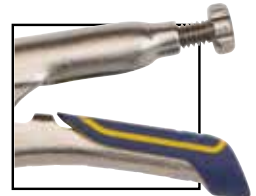

BEST IN CLASS STRENGTH

20% REDUCED HAND SPAN.*
STOP THE STRAIN,
FORGET THE FATIGUE.



BUILT STRONG TO LAST LONG

PATENTED REDUCED HAND SPAN DESIGN*



HEX KEY ADJUSTING SCREW

ONE-HANDED, TRIGGERLESS RELEASE**

T11T

- BEST IN CLASS STRENGTH**
Holds up under the most extreme conditions.
- PATENTED REDUCED HAND SPAN DESIGN***
The opening of the new locking pliers handles is reduced by 20%.
- ONE-HANDED, TRIGGERLESS RELEASE****
Makes it twice as easy to open than traditional design with no pinch points.

- HEX KEY ADJUSTING SCREW**
Tightens to draw material closer together for tighter grip. Loosens to provide controlled release.
- BUILT STRONG TO LAST LONG**
High grade alloy steel is heat treated for maximum toughness and durability and provides longer life compared to other locking tools.
- RECESSED TEXTURE IN STEEL**
For secure hold in hands.

3X GRIPPING POWER***



CURVED JAW LOCKING PLIERS

Self-energising lower jaw provides three times more gripping power, with no slipping or stripping on any style nut or bolt head.

T10T



10508017



ITEM NO.	DESCRIPTION	CAPACITY	EAN	MASTER PACK	SHELF PACK
Fast Release					
T10T	Fast Release - 5CR 5"/ 125mm	29mm	5706915081459	25	5
T13T	Fast Release - 7CR 7"/ 175mm	38mm	5706915081442	25	5
T11T	Fast Release - 10CR 10"/ 250mm	48mm	5706915081435	25	5
The Original					
10508019	Original - 5CR 5"/ 125mm	29mm	5706915080193	25	5
10508018	Original - 7CR 7"/ 175mm	38mm	5706915080186	25	5
10508017	Original - 10CR 10"/ 250mm	48mm	5706915080179	25	5

*Reduced hand span applies to 10"/250mm and 11"/275mm models only. **Compared to traditional locking pliers. ***Compared to previous VISE-GRIP® FAST RELEASE™ WR Locking Pliers. CR models only.

STRAIGHT JAW LOCKING PLIERS

Straight jaw provides maximum contact on flat, square or hex materials.

ITEM NO.	DESCRIPTION	CAPACITY	EAN	MASTER PACK	SHELF PACK
Fast Release					
T03T	Fast Release - 7R 7"/ 175mm	38mm	5706915081800	25	5
T01T	Fast Release - 10R 10"/ 250mm	48mm	5706915081794	25	5
The Original					
T0302EL4	Original - 7R 7"/ 175mm	38mm	0038548003016	25	5
T0102EL4	Original - 10R 10"/ 250mm	48mm	0038548001067	25	5



T01T



T0102EL4

CURVED JAW LOCKING PLIERS WITH WIRE CUTTER

The curved jaw provides for a better fit around curved work shapes. Built-in wire cutter is great for a variety of applications and material shapes.

ITEM NO.	DESCRIPTION	CAPACITY	EAN	MASTER PACK	SHELF PACK
Fast Release					
T09T	Fast Release - 5WR 5"/ 125mm	29mm	5706915081428	25	5
T07T	Fast Release - 7WR 7"/ 175mm	38mm	5706915081411	25	5
T05T	Fast Release - 10WR 10"/ 250mm	48mm	5706915081404	25	5
The Original					
T1002EL4	Original - 4WR 4"/ 100mm	25mm	0038548001098	25	5
T0902EL4	Original - 5WR 5"/ 125mm	29mm	0038548009063	25	5
T0702EL4	Original - 7WR 7"/ 175mm	38mm	0038548007038	25	5
T0502EL4	Original - 10WR 10"/ 250mm	48mm	0038548000510	25	5



T05T



T0902EL4

LONG NOSE LOCKING PLIERS WITH WIRE CUTTER

Long, straight nose provides easy access in narrow, hard-to-reach places.

ITEM NO.	DESCRIPTION	CAPACITY	EAN	MASTER PACK	SHELF PACK
Fast Release					
T14T	Fast Release - 6LN 6"/150mm	51mm	5706915081466	25	5
T15T	Fast Release - 9LN 9"/225mm	70mm	5706915081473	25	5
The Original					
T1602EL4	Original - 4LN 4"/100mm	41mm	0038548001678	25	5
T1402EL4	Original - 6LN 6"/150mm	51mm	0038548001432	25	5
T1502EL4	Original - 9LN 9"/225mm	70mm	0038548001517	25	5



T15T



T1502EL4

LOCKING C-CLAMPS WITH REGULAR TIPS

Wide-opening jaw provides greater versatility in clamping a variety of shapes.

ITEM NO.	DESCRIPTION	CAPACITY	EAN	MASTER PACK	SHELF PACK
Fast Release					
T17T	Fast Release - 6R 6"/150mm	54mm	5706915071900	25	5
T19T	Fast Release - 11R 11"/275mm	102mm	5706915071894	25	5
The Original					
T17EL4	Original - 6R 6"/150mm	54mm	0038548001715	25	5
T19EL4	Original - 11R 11"/275mm	102mm	0038548001913	25	5
T18R	Original - 18R - 18"/455mm	203mm	0038548000213	-	5
T24R	Original - 24R - 24"/605mm	254mm	0038548002750	-	5



T19T



T19EL4

LOCKING C-CLAMPS WITH DEEP THROAT

The large C-Clamp with greater throat capacity makes this a highly versatility versatile tool in the clamping of wider work-pieces.

ITEM NO.	DESCRIPTION	CAPACITY	EAN	MASTER PACK	SHELF PACK
The Original					
T18DR	Original - 18DR Locking Clamp Deep Throat 18"/455mm	190mm	0038548002118	-	5



T18DR



WISE-GRIP®

LOCKING C-CLAMPS WITH SWIVEL PADS

The swivelling pads and greater throat depth allow this clamp to hold irregular shapes and tapered work pieces.



T20EL4

ITEM NO.	DESCRIPTION	CAPACITY	EAN	MASTER PACK	SHELF PACK
T165EL4	Original - 4SP Locking C-Clamp 4"/100mm	41mm	0038548001661	25	5
T18EL4	Original - 6SP Locking C-Clamp 6"/150mm	54mm	0038548001845	25	5
T9SP	Original - 9SP Locking C-Clamp 9"/225mm	114mm	0038548003108	25	5
T20EL4	Original - 11SP Locking C-Clamp 11"/275mm	102mm	0038548002019	25	5
T18SP	Original - 18SP Locking C-Clamp 18"/455mm	203mm	0038548000220	-	5
T24SP	Original - 24SP Locking C-Clamp 24"/605mm	254mm	0038548000282	-	5

LOCKING WRENCHES

The heavy-duty jaws lock onto three sides of hex fasteners and won't slip or mark workpieces.



4

ITEM NO.	DESCRIPTION	CAPACITY	EAN	MASTER PACK	SHELF PACK
8	Original - 4LW Locking Wrench 4"/100mm	7-14mm	0038548002415	25	5
4	Original - 7LW Locking Wrench 7"/175mm	11-19mm	0038548000046	25	5
2	Original - 10LW Locking Wrench 10"/250mm	16-28mm	0038548000022	25	5

LARGE JAW LOCKING PLIERS

The heavy-duty jaws grip all shapes; ideal for plumbers, mechanics, welders and large jobs.



12L3

ITEM NO.	DESCRIPTION	CAPACITY	EAN	MASTER PACK	SHELF PACK
12L3	Original - 12LC Large Jaw Locking Plier 12"/300mm	79mm	0038548012018	25	5

LOCKING SHEET METAL TOOL

The sheet metal tool makes bending, forming and crimping sheet metal easier.

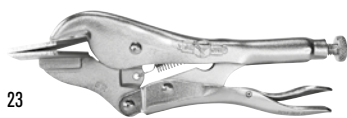

23

ITEM NO.	DESCRIPTION	CAPACITY	EAN	MASTER PACK	SHELF PACK
23	Original - 8R Locking Sheet Metal Tool 8"/200mm	78mm	0038548000237	25	5

LOCKING PINCH OFF TOOL

The pinch-off tool provides a temporary seal when applied to tubing, leaving both hands free for other work.



29

ITEM NO.	DESCRIPTION	CAPACITY	EAN	MASTER PACK	SHELF PACK
29	Original - 7RR Locking Pinch-Off Tool 7"/175mm	6mm	0038548000299	25	5

LOCKING PANEL CLAMP

The specially designed jaw provides quick clamping and alignment of automotive body panels.



251

ITEM NO.	DESCRIPTION	CAPACITY	EAN	MASTER PACK	SHELF PACK
251	Original - 9AC Locking Panel Clamp 9"/225mm	70mm	0038548002514	25	5

LOCKING WELDING CLAMP

The U-shape jaw provides enhanced visibility of the weld area and access to the weld space, allowing for more accurate alignment of both round and square shape tubing during welding.



25ZR

ITEM NO.	DESCRIPTION	CAPACITY	EAN	MASTER PACK	SHELF PACK
25ZR	Original - 9R Locking Welding Clamp 9"/225 mm	70 mm	0038548000251	25	5

LOCKING CHAIN CLAMP

The chain holds and locks any shape or size up to 18"/455mm. Extension chains are available to extend to any length required.

ITEM NO.	DESCRIPTION	EAN	MASTER PACK	SHELF PACK
27ZR	Original - 20R Locking Chain Clamp 9"/225mm	0038548000275	10	5



LOCKING PLIERS SPARE PARTS

ITEM NO.	DESCRIPTION	EAN	PCE PER PACK	MASTER PACK	SHELF PACK
2071910	Adjusting Screw 5 Pc. - 10R, 10WR, 10CR, 20R, 12LC, 11R, 11SP, 18R, 18SP, 24R, 24SP, & 10LW	0038548095455	5	100	5
4092	Replacement spring 5pc - 4WR, 4LN, 4SP, 4LW	0038548040929	5	100	5
4935309	Replacement spring 5pc - 18R, 18SP, 24R, 24SP (box and packs marked 40-34)	0038548040349	5	100	5
4008	Replacement spring 5pc - 10R, 10WR, 10CR, 11R, 11SP, 20R, 12LC, 10LW	0038548040080	5	100	5
4022ZR	Replacement spring 5pc - 7R, 7WR, 7CR, 9LN, 8R, RR, 7LW	0038548040226	5	100	5
4052ZR	Replacement spring 5pc - 5WR, 6LN, 6R, 6SP	0038548040523	5	100	5



LOCKING PLIERS SETS



T77T



T214T



T76KBT



10508020



T71









ITEM NO.	DESCRIPTION	EAN	MASTER PACK	SHELF PACK
T77T	2 pc. Fast Release - (10WR, 6LN)	5706915081480	25	5
T214T	2 pc. Fast Release - (10WR, 7WR)	5706915081497	25	5
T76KBT	3 pc. Fast Release - (10WR, 9LN, 7R) in kitbag	5706915081503	25	5
10508020	3 pc. Original - (5CR, 7CR, 10CR) in storage tray	5706915080209	25	5
T71	4 pc. Original - (10CR, 7R, 6LN, 5WR), in kitbag	0038548000718	-	5

WISE-GRIP®

LOCKING PLIER RANGE OVERVIEW

IMAGE	ITEM NO.	DESCRIPTION	SIZES	JAW CAPACITY	DESCRIPTION	RECOMMENDED APPLICATIONS
	T10T	5CR 5" / 125mm	5" / 125mm	1-1/8" / 29 mm	CURVED JAW LOCKING PLIERS Great for securely gripping and torquing multiple surface shapes, including round pipes, square or hex bolts, and more. Perfect for any application that requires maximum torque.	Gripping Torque Rusted/Broken Screws
	T13T	7CR 7" / 175mm	7" / 175mm	1-1/2" / 38 mm		
	T11T	10CR 10" / 250mm	10" / 250mm	1-7/8" / 48 mm		
	T0508019	5CR 5" / 125mm	5" / 125mm	1-1/8" / 29 mm		
	T0508018	7CR 7" / 175mm	7" / 175mm	1-1/2" / 38 mm		
	T0508017	10CR 10" / 250mm	10" / 250mm	1-7/8" / 48 mm		
	T03T	7R 7" / 175mm	7" / 175mm	1-1/2" / 38 mm	STRAIGHT JAW LOCKING PLIERS The straight jaw pliers with heavy-duty jaws allow for maximum contact on all work shapes flat or square. It is very popular in welding and other metal work. Use for safer grinding or as a portable vice. The solid steel head makes this tool twice as strong as all other locking pliers.	Holding Welding Clamping
	T01T	10R 10" / 250mm	10" / 250mm	1-7/8" / 48 mm		
	T0302EL4	7R 7" / 175mm	7" / 175mm	1-1/2" / 38 mm		
	T0102EL4	10R 10" / 250mm	10" / 250mm	1-7/8" / 48 mm		
	T09T	5WR 5" / 125mm	5" / 125mm	1-1/8" / 29 mm	CURVED JAW LOCKING PLIERS WITH WIRE CUTTER The curved jaw pliers provide for a better fit around curved work shapes. Curved jaw with built-in wire cutter great for a variety of applications and material shapes.	Wire Cutting Pulling, Prying Gripping
	T07T	7WR 7" / 175mm	7" / 175mm	1-1/2" / 38 mm		
	T05T	10WR 10" / 250mm	10" / 250mm	1-7/8" / 48 mm		
	T11002EL4	4WR 4" / 100mm	4" / 100mm	1" / 25 mm		
	T0902EL4	5WR 5" / 125mm	5" / 125mm	1-1/8" / 29 mm		
	T0702EL4	7WR 7" / 175mm	7" / 175mm	1-1/2" / 38 mm		
	T0502EL4	10WR 10" / 250mm	10" / 250mm	1-7/8" / 48 mm		
	T14T	6LN 6" / 150mm	6" / 150mm	2" / 51 mm	LONG NOSE LOCKING PLIERS WITH WIRE CUTTER The long tapered nose plier is ideal for delicate work, hobbies, tight spaces, electronics and clamping of small parts. The long nose plier features a built in wire cutter which is helpful in tight spaces.	Reaching Bending Pinching
	T15T	9LN 9" / 225mm	9" / 225mm	2-3/4" / 70 mm		
	T11602EL4	4LN 4" / 100mm	4" / 100mm	1-5/8" / 41 mm		
	T11402EL4	6LN 6" / 150mm	6" / 150mm	2" / 51 mm		
	T11502EL4	9LN 9" / 225mm	9" / 225mm	2-3/4" / 70 mm		
	T17T	6R 6" / 150mm	6" / 150mm	2-1/8" / 54 mm	LOCKING C-CLAMPS WITH REGULAR TIPS The wide-opening jaws provide greater versatility in clamping projects than otherwise available with old fashioned clamps. The C-clamps with regular tips are very popular in welding, auto-body repair and other metal work. The fast release option allows users to move the clamps quickly with one hand while continuing to work with the other.	Fabricating Welding Construction
	T19T	11R 11" / 275mm	11" / 275mm	4" / 102 mm		
	T17EL4	6R 6" / 150mm	6" / 150mm	2-1/8" / 54 mm		
	T19EL4	11R 11" / 275mm	11" / 275mm	4" / 102 mm		
	T18R	18R 18" / 455mm	18" / 455mm	8" / 203 mm		
	T24R	24R 24" / 605mm	24" / 254mm	10" / 254 mm		

PLIERS & WRENCHES

IMAGE	ITEM NO.	DESCRIPTION	SIZES	JAW CAPACITY	DESCRIPTION	RECOMMENDED APPLICATIONS
	T165EL4	4SP 4"/ 100mm	4"/ 100mm	1-5/8" / 41 mm	LOCKING C-CLAMPS WITH SWIVEL PADS The wide-opening jaws with swivel pads hold tapered work, awkward fabricating jobs and delicate projects. The C-Clamps with swivel pads are very popular in auto-body repair and other work on delicate or odd shaped surfaces.	Holding Delicate Seams
	T18EL4	6SP 6"/ 150mm	6"/ 150mm	2-1/8" / 54 mm		
	T9SP	9SP 9"/ 225mm	9"/ 225mm	4-1/2" / 114 mm		
	T20EL4	11SP 11"/ 275mm	11"/ 275mm	4" / 102 mm		
	T18SP	18SP 18"/ 455mm	18"/ 455mm	8" / 203 mm		
	T24SP	24SP 24"/ 605mm	24"/ 254mm	10" / 254 mm		
	T18DR	18DR 18"/ 455mm	18"/ 455mm	7-1/2" / 190 mm	LOCKING C-CLAMPS - DEEP THROAT These clamps have extra throat width and depth for greater clamping reach. These features allow for many clamping applications in welding, automotive and steel framing.	Fabricating Welding Construction
	23	8R 8"/ 200mm	8"/ 200mm	3-1/8" / 78 mm	LOCKING SHEET METAL TOOL The Locking Sheet Metal tool locks on to work with a powerful grip. The tool makes all kinds of bending, forming and crimping jobs easier and faster.	Bending Crimping Forming
	25ZR	9R 8"/ 225mm	9"/ 225mm	2-3/4" / 70 mm	LOCKING WELDING CLAMP The Locking Welding Clamp has deep-throated and U-shaped jaws for visibility and working space. It holds work in proper alignment and is ideal for sheet metal work on automobiles.	Welding Holding
	27ZR	20R 9"/ 225mm	9"/ 225mm	18" / 455 mm	LOCKING CHAIN CLAMP The Locking Chain Clamp holds and locks around any shape or any size of object and adjusts quickly for ratchet action in either direction. Extension chain is available.	Holding
	29	RR 7"/ 175mm	7"/ 175mm	1/4" / 6 mm	LOCKING PINCH-OFF TOOL The Locking Pinch-Off tool with round jaws pinches and locks on tubing instantly without damaging the tubing. It is perfect to use for plumbing work, as it stops flow from untidy tubes. Very popular in the refrigeration market.	Holding
	251	9AC Locking Panel Clamp	9"/ 225mm	2-3/4" / 70 mm	LOCKING PANEL CLAMP The jaws for the Locking Panel Clamp are designed to move in a straight line motion which allows the handle to be out of the way. Auto-body panels can be clamped in place and the door shut to check for gaps before final welding.	Clamping Welding
	8	4LW 4"/ 100mm	4"/ 100mm	7 mm - 14 mm	LOCKING WRENCH The jaws of the Locking Wrench lock on three sides of a bolt and will not slip or mark. The Locking Wrench is adjustable to over 16 wrench sizes and features a built-in wire cutter.	Pulling Tightening
	4	7LW 7"/ 175mm	7"/ 175mm	11 mm - 19 mm		
	2	10LW 10"/ 250mm	10"/ 250mm	16 mm - 28 mm		
	12L3	12LC 12"/ 300mm	12"/ 300mm	3-1/8" / 79 mm	LARGE JAW LOCKING PLIER The large jaws and clamping ability make this tool ideal for plumbers, mechanics, welders and others who work with large objects. Also, its convenient size makes it easier to use than bulkier tools, such as pipe wrenches.	Holding Clamping





WISE-GRIP®

GROOVELOCK WATER PUMP PLIERS WITH PROTOUCH™ GRIP

ALL-PURPOSE JAW

PRESS-N-SLIDE BUTTON

ANTI-PINCH NON-SLIP PROTOUCH GRIPS



10507627

MULTI-GROOVE RATCHETING SYSTEM

WATER PUMP PLIERS

GrooveLock Pliers are designed with twice the number of groove positions as traditional groove joint pliers to deliver optimal hand and jaw positioning - providing a superior grip. The specially engineered, all-purpose jaw grips round, hex, square and flat surfaces for incredible versatility.



- 1. ALL-PURPOSE JAW**
Grips onto flat, round, hex & square work pieces to provide tremendous bite
- 2. PRESS-N-SLIDE BUTTON**
Adjusts jaws 2X faster than traditional groove joint pliers
- 3. MULTI-GROOVE RATCHETING SYSTEM**
Has twice the groove positions than other groove joint pliers, for precise positioning on any type of work surface
- 4. ANTI-PINCH NON-SLIP PROTOUCH GRIPS**
Provide comfort, control and less hand fatigue

2X FASTER*
*vs traditional Groove Joint pliers

ProTouch™
GRIPS

GrooveLock
Pliers

ITEM NO.	DESCRIPTION	JAW CAPACITY	EAN	MASTER PACK	SHELF PACK
10507626	GV6 GrooveLock PTG 6"/150mm	29mm	5706915076264	25	5
10507627	GV8 GrooveLock PTG 8"/200mm	45mm	5706915076271	25	5
10507628	GV10 GrooveLock PTG 10"/250mm	57mm	5706915076288	25	5
4935097	GV10S GrooveLock PTG 10"/250mm Smooth Jaw	57mm	0038548108629	25	5
10507629	GV12 GrooveLock PTG 12"/300mm	70mm	5706915076295	20	5



10507628



4935097

GROOVELOCK WATER PUMP PLIERS WITH THIN GRIP

ITEM NO.	DESCRIPTION	CAPACITY	EAN	MASTER PACK	SHELF PACK
10507630	GV6 GrooveLock TG 6"/150mm	29mm	5706915076301	25	5
10507631	GV8 GrooveLock TG 8"/200mm	45mm	5706915076318	25	5
10507632	GV10 GrooveLock TG 10"/250mm	57mm	5706915076325	20	5
10507633	GV12 GrooveLock TG 12"/300mm	70mm	5706915076332	25	5
2078116	GV16 GrooveLock TG 16"/400mm	114mm	0038548088099	10	2
2078120	GV20 GrooveLock TG 20"/510mm	152mm	0038548088105	5	1



10507632

WISE-GRIP®

WATER PUMP PLIERS

IRWIN® VISE-GRIP® Universal Water Pump pliers feature an all-purpose jaw, specially engineered to grip round, hex, square and flat surfaces. They are available with ProTouch™ grips (PTG) or thin grips (TG).

UNIVERSAL WATER PUMP PLIERS WITH PROTOUCH™ GRIP



10507636

ITEM NO.	DESCRIPTION	CAPACITY	EAN	MASTER PACK	SHELF PACK
10507634	Universal Water Pump Pliers PTG 6"/150mm	29mm	5706915076349	25	5
10507635	Universal Water Pump Pliers PTG 8"/200mm	45mm	5706915076356	25	5
10507636	Universal Water Pump Pliers PTG 10"/250mm	57mm	5706915076363	25	5
10507637	Universal Water Pump Pliers PTG 12"/300mm	70mm	5706915076370	25	5

UNIVERSAL WATER PUMP PLIERS WITH THIN GRIP



10507640

ITEM NO.	DESCRIPTION	CAPACITY	EAN	MASTER PACK	SHELF PACK
10507638	Universal Water Pump Pliers TG 6"/150mm	29mm	5706915076387	25	5
10507639	Universal Water Pump Pliers TG 8"/200mm	45mm	5706915076394	25	5
10507640	Universal Water Pump Pliers TG 10"/250mm	57mm	5706915076400	25	5
10507641	Universal Water Pump Pliers TG 12"/300mm	70mm	5706915076417	25	5

GROOVE JOINT PLIERS

IRWIN® VISE-GRIP® Groove Joint pliers feature right angle teeth which grip in all directions for maximum bite. They all have moulded ProTouch™ grips for added comfort and less hand fatigue.

GROOVE JOINT PLIERS WITH PROTOUCH™ GRIPS



10505500

ITEM NO.	DESCRIPTION	CAPACITY	EAN	MASTER PACK	SHELF PACK
10505498	Groove Joint Plier 8"/200mm	38mm	5706915054989	25	5
10505500	Groove Joint Plier 10"/250mm	51mm	5706915055009	25	5
10505502	Groove Joint Plier 12"/300mm	57mm	5706915055023	25	5

WISE-GRIP®

WISE-GRIP® PLIERS

IRWIN® VISE-GRIP® traditional pliers have induction hardened cutting edges which stay sharp longer. The pliers also feature machined jaws for maximum gripping strength and moulded ProTouch™ grips for added comfort and less hand fatigue.



COMBINATION PLIERS



- MULTI-GRIP JAWS**
With maximum gripping groove design
- PROTOUCH™ GRIPS**
Are moulded for comfort and provide less hand fatigue
- INDUCTION HARDENED CUTTING FACE**
To stay sharper, longer
- CABLE CUTTER**
Up to Ø 1,6mm cables
- CHROMIUM NICKEL STEEL**
For improved durability on the gripping and cutting face

ITEM NO.	DESCRIPTION	EAN	MASTER PACK	SHELF PACK
10505875	Combination Plier 6"/150mm	5706915058758	25	5
1910231	Combination Plier 7"/175mm	5706915058772	25	5
10505876	Combination Plier 8"/200mm	5706915058765	25	5



DIAGONAL CUTTING PLIERS

Induction hardened cutting edges designed to stay sharper longer for wire cutting.

ITEM NO.	DESCRIPTION	EAN	MASTER PACK	SHELF PACK
10505493	Diagonal Cutting Pliers 6"/150mm	5706915054934	25	5
10505494	Diagonal Cutting Pliers 7"/175mm	5706915054941	25	5
10505495	Diagonal Cutting Pliers 8"/200mm	5706915054958	25	5



END CUTTING PLIERS

Throat clearance allows semi-flush cutting of nails and rivets.

ITEM NO.	DESCRIPTION	EAN	MASTER PACK	SHELF PACK
10505517	End Cutting Pliers 8"/200mm	5706915055177	25	5



CABLE CUTTER

Cuts copper and aluminium wire.

ITEM NO.	DESCRIPTION	EAN	MASTER PACK	SHELF PACK
10505518	Cable Cutter 8"/200mm	5706915055184	25	5



WISE-GRIP®

LONG NOSE PLIERS

Thin nose profile gets into tight spaces and is easier to reach around obstructions.



10505504

ITEM NO.	DESCRIPTION	EAN	MASTER PACK	SHELF PACK
10505503	Long Nose Pliers 6"/150mm	5706915055030	25	5
10505504	Long Nose Pliers 8"/200mm	5706915055047	25	5

BENT NOSE PLIERS

Thin, angled nose profile gets into tight spaces and is easier to reach around obstructions.



10505506

ITEM NO.	DESCRIPTION	EAN	MASTER PACK	SHELF PACK
10505505	Bent Nose Pliers 6"/150mm	5706915055054	25	5
10505506	Bent Nose Pliers 8"/200mm	5706915055061	25	5

NIPPER PLIERS

Throat clearance allows for semi-flush cutting.



10508151

ITEM NO.	DESCRIPTION	EAN	MASTER PACK	SHELF PACK
10508153	Nipper Plier TG 6"/150mm	5706915081534	25	5
10508152	Nipper Plier TG 7"/175mm	5706915081527	25	5
10508151	Nipper Plier TG 8"/200mm	5706915081534	25	5

CONSTRUCTION NIPPERS

Precision-machined jaws and induction hardened cutting edge provide a clean cut.



10508154

ITEM NO.	DESCRIPTION	EAN	MASTER PACK	SHELF PACK
10508154	Construction Nippers TG 9"/225mm	5706915081541	25	5

NAIL PULLERS

Machined jaws provide maximum gripping strength.



10508157

ITEM NO.	DESCRIPTION	EAN	MASTER PACK	SHELF PACK
10508156	Nail Puller TG 10"/250mm	5706915081565	25	5
10508157	Nail Puller TG 8"/200mm	5706915081572	25	5

TRADITIONAL PLIER SET



10505483

ITEM NO.	DESCRIPTION	EAN	MASTER PACK	SHELF PACK
10505483	ProPliers 3pcs Set (6"/150mm Diagonal Cutter, 8"/200mm Long Nose Plier, 7"/175mm Combination Plier)	5706915054835	5	5

ADJUSTABLE WRENCHES

IRWIN® VISE-GRIP® wrenches have scales in metric and imperial, and are available with ProTouch™ Grip for added comfort. Parallel jaws with smooth surfaces assist a secure grip and help prevent scratches.

ADJUSTABLE WRENCH WITH PROTOUCH GRIP

ITEM NO.	DESCRIPTION	CAPACITY	EAN	MASTER PACK	SHELF PACK
10505486	Adjustable Wrench PTG 6"/150mm	1"/25mm	5706915054866	25	5
10505488	Adjustable Wrench PTG 8"/200mm	1-1/8" / 28mm	5706915054880	25	5
10505490	Adjustable Wrench PTG 10"/250mm	1-1/4" / 31mm	5706915054903	25	5
10505492	Adjustable Wrench PTG 12"/300mm	1-1/2" / 38mm	5706915054927	20	5



10505492

ProTouch
GRIPS

ADJUSTABLE WRENCH WITH STEEL HANDLE

ITEM NO.	DESCRIPTION	CAPACITY	EAN	MASTER PACK	SHELF PACK
10508161	Adjustable Wrench Steel Handle 6"/150mm	1" / 25mm	5706915081619	20	5
10508160	Adjustable Wrench Steel Handle 8"/200mm	1-1/8" / 28mm	5706915081602	20	5
10508159	Adjustable Wrench Steel Handle 10"/250mm	1-1/4" / 31mm	5706915081596	20	5
10508158	Adjustable Wrench Steel Handle 12"/300mm	1-1/2" / 38mm	5706915081589	20	5



10508160



WISE-GRIP®

VDE PLIERS

CROSS-HATCHED
JAWS

CABLE CUTTER

INDUCTION HARDENED
CUTTING FACE

PROTOUCH™ GRIPS

VDE COMBINATION PLIERS

IRWIN® Vise-Grip® VDE Pliers are fully VDE certified, meaning they are guaranteed safe for working with electrical equipment up to AC 1000V or DC 1500V. Their induction hardened cutting edges stay sharp longer, and their machined jaws are designed for maximum gripping strength. Plus, their ProTouch™ grips provide extra comfort for less hand fatigue.



CHROMIUM
NICKEL STEEL

1. **CROSS-HATCHED JAWS**
Maximum gripping
2. **PROTOUCH™ GRIPS**
For comfort and reduced hand fatigue
3. **INDUCTION HARDENED CUTTING FACE**
Stays sharper longer
4. **CABLE CUTTER**
Up to Ø 1.6mm cables
5. **CHROMIUM NICKEL STEEL**
For improved durability on the gripping and cutting face

ProTouch™
GRIPS



10505874

ITEM NO.	DESCRIPTION	EAN	MASTER PACK	SHELF PACK
10505872	VDE Combination Pliers 6"/150mm	5706915058727	25	5
10505873	VDE Combination Pliers 7"/175mm	5706915058734	25	5
10505874	VDE Combination Pliers 8"/200mm	5706915058741	25	5

VDE LONG AND BENT NOSE PLIERS

Thin nose profile gets into tight spaces, easy to reach around obstructions.



10505869

10505870

ITEM NO.	DESCRIPTION	EAN	MASTER PACK	SHELF PACK
10505868	VDE Long Nose Pliers 6"/150mm	5706915058680	25	5
10505869	VDE Long Nose Pliers 7"/200mm	5706915058697	25	5
10505870	VDE Bent Nose Pliers 8"/200mm	5706915058703	25	5

VDE DIAGONAL CUTTING PLIERS

Induction hardened cutting edges designed to stay sharper longer for wire cutting.

ITEM NO.	DESCRIPTION	EAN	MASTER PACK	SHELF PACK
10505865	VDE Diagonal Cutting Pliers 6"/150mm	5706915058659	25	5
10505866	VDE Diagonal Cutting Pliers 7"/175mm	5706915058666	25	5
10505867	VDE Diagonal Cutting Pliers 8"/200mm	5706915058673	25	5



10505865

VDE WIRE STRIPPER

V-shape Cutters provide easy and precise wire stripping up to Ø 1,6 mm cables.

ITEM NO.	DESCRIPTION	EAN	MASTER PACK	SHELF PACK
10505871	VDE Wire Strippers 6"/150mm	5706915058710	25	5



VDE PLIERS SET

ITEM NO.	DESCRIPTION	EAN	MASTER PACK	SHELF PACK
10505519	3pcs Set (6"/150mm diagonal cutter, 8"/200mm long nose plier, 7"/175mm combination plier)	5706915055191	5	5



10505519



WHAT IS VDE

▪ SAFELY WORKING WITH ELECTRICAL EQUIPMENT UP TO AC OR CD1500VOLT





Record®

PIPE WRENCHES

IRWIN® Record® offer a full range of plumbing tools designed to get the job done quickly and efficiently. From our solid-forged Stillson Wrenches to the lightweight Quick-Adjusting Wrench, our range of pipe tools offer superior grip due to the unique 'V-shaped' tooth profile.

FORGED HOOK JAW

QUICK-ADJUSTING JAW

CAST ALUMINIUM CONSTRUCTION

IRWIN RECORD® QUICK-ADJUSTING PIPE WRENCH



1. FORGED HOOK JAW

With 2-1/4" (58mm) jaw capacity equivalent to standard 14" (350mm) pipe wrench; ideal for pipe diameters up to 1-1/2" (38mm); ideal for most surfaces including black, galvanized, PVC and copper pipe, as well as nuts, bolts and couplings; broached teeth

2. QUICK-ADJUSTING JAW

With one-handed operation, ratchets quickly to work the surface

3. CAST ALUMINIUM CONSTRUCTION

40% less weight than standard 14" (350mm) cast iron pipe wrench; ergonomic handle is ideal for heavy torque and maximum comfort

3X FASTER*

ITEM NO.	DESCRIPTION	CAPACITY	EAN	MASTER PACK	SHELF PACK
10503642	Quick-Adjusting Wrench	3 - 58mm	5706915036428	-	5

STILLSON PIPE WRENCHES

Solid forged handle and jaw with One Piece Unbreakable (S.G.) iron.

ITEM NO.	DESCRIPTION	CAPACITY	EAN	MASTER PACK	SHELF PACK
T3008	Stillson Wrench 8"/200mm	3/4" / 19mm	0734442111122	-	6
T30010	Stillson Wrench 10"/250mm	1" / 25mm	0734442111368	-	6
T30012	Stillson Wrench 12"/300mm	1-1/4" / 32mm	0734442111603	-	6
T30014	Stillson Wrench 14"/350mm	1-1/2" / 38mm	0734442111849	-	6
T30018	Stillson Wrench 18"/450mm	2" / 51mm	0734442111962	-	6
T30024	Stillson Wrench 24"/600mm	2-1/2" / 63mm	0734442112082	-	6
T30036	Stillson Wrench 36"/900mm	3-1/2" / 89mm	0734442112204	-	6



STILLSON WRENCHES SPARE PARTS

ITEM NO.	DESCRIPTION	EAN	MASTER PACK	SHELF PACK
T30018A	Jaw Complete with Nut (F)	0734442120605	1	4
T30036A	Jaw Complete with Nut (F)	0734442121800	1	4
T30018C	Frame with Pin (D) & Coil Spring (E)	0734442120841	1	4
T30036C	Frame with Pin (D) & Coil Spring (E)	0734442122043	1	4
T30024F	Nut (New Thread)	0734442117728	1	4
T30036F	Nut	0734442119883	1	1

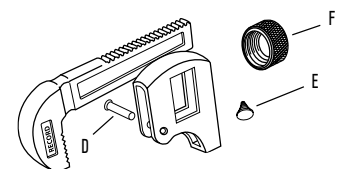

* Than traditional pipe wrenches

Record®

LEADER PIPE WRENCHES

Heavy-duty frame and handle are a one-piece ductile iron casting guaranteed against breakage.



T3508

ITEM NO.	DESCRIPTION	CAPACITY	EAN	MASTER PACK	SHELF PACK
T3508	Leader Wrench 8"/200mm	1" (25mm)	0734442112440	-	4
T35010	Leader Wrench 10"/250mm	1-1/2" (38mm)	0734442112563	-	4
T35012	Leader Wrench 12"/300mm	2" (51mm)	0734442112327	-	4
T35014	Leader Wrench 14"/350mm	2" (51mm)	0734442112686	-	4
T35018	Leader Wrench 18"/450mm	2-1/2" (63mm)	0734442112808	-	4
T35024	Leader Wrench 24"/600mm	3" (76mm)	0734442112921	-	1
T35036	Leader Wrench 36"/900mm	5" (127mm)	0734442113041	-	1
T35048	Leader Wrench 48"/1220mm	6" (152mm)	0734442113065	-	1

LEADER WRENCHES SPARE PARTS

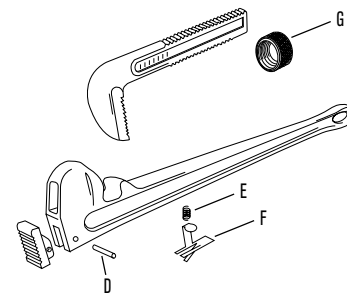

ITEM NO.	DESCRIPTION	CAPACITY	EAN	MASTER PACK	SHELF PACK
T35018A	Hook Jaw c/w Nut (G)	-	0734442125280	1	4
T35024A	Hook Jaw c/w Nut (G)	-	0734442126126	1	4
T35036A	Hook Jaw c/w Nut (G)	-	0734442126966	1	4
T35048A	Hook Jaw c/w Nut (G)	-	0734442127802	1	4
T35010C	Handle Jaw with Pin (D)	-	0734442123842	1	4
T35018C	Handle Jaw with Pin (D)	-	0734442125402	1	1
T35024C	Handle Jaw with Pin (D)	-	0734442126249	1	1
T35048C	Handle Jaw with Pin (D)	-	0734442127925	1	1
T35010E	Coil Spring (E) & Flat Spring (F)	-	0734442124085	1	1

HANDIWRENCH

Chain pipe wrenches are mainly used in confined spaces, such as against a wall or close to a nest of other piping. Simply loop the chain around the pipe, lock it and the jaws will grip in the direction of the turn. The pipe can then be easily tightened or loosened with short strokes of the handle.



ITEM NO.	DESCRIPTION	CAPACITY	EAN	MASTER PACK	SHELF PACK
T240	Handi-wrench Ø100	4" (101mm)	0734442113522	48	4

CHAIN PIPE WRENCHES



T235C

ITEM NO.	DESCRIPTION	CAPACITY	EAN	MASTER PACK	SHELF PACK
T23112	Chain Pipe Wrench Ø61mm/14"	5/16" - 2" / 8-51mm	0734442109082	12	1
T23212	Chain Pipe Wrench Ø90mm/21-1/2"	5/16" - 3" / 8-76mm	0734442109204	12	1
T233C	Chain Pipe Wrench Ø115mm/36"	1/2" - 4" / 13-101mm	0734442113164	6	1
T234C	Chain Pipe Wrench Ø220mm/51"	1" - 8" / 25-203mm	0734442113287	6	1
T235C	Chain Pipe Wrench 64-1/2"	2" - 12" / 50 - 300mm	0734442114000	6	1

CHAIN PIPE WRENCHES REPLACEMENT CHAINS

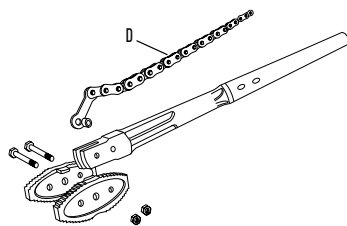

ITEM NO.	DESCRIPTION	CAPACITY	EAN	MASTER PACK	SHELF PACK
T233CDB	Chain with Bush (D)	-	0734442113881	1	1
T234CDB	Chain with Bush (D)	-	0734442114246	1	1

METAL CUTTING



HACKSAW BLADES

BI-METAL HACKSAW BLADES

IRWIN® high-quality hacksaw blades provide improved cutting performance. Their tooth geometry delivers higher resistance against tooth strippage and increases longevity and durability. Leveraging the advantages of WeldTec™ technology, IRWIN® hacksaw blades allow for faster, smoother and less tiring cutting.



1. **WELDTEC TECHNOLOGY**
Innovative tooth geometry withstands wear and keeps the blade sharp for a long time
2. **BI-METAL CONSTRUCTION**
Prevents blades from shattering and delivers long blade life

BI-METAL HACKSAW BLADES

ITEM NO.	DESCRIPTION	EAN	MASTER PACK	SHELF PACK
10504523	Bi-Metal Hacksaw Blade 18TPI, 12" / 300mm, 2 pcs.	5706915045239	90	1
10504524	Bi-Metal Hacksaw Blade 24TPI, 12" / 300mm, 2 pcs.	5706915045246	90	1
10504525	Bi-Metal Hacksaw Blade 32TPI, 12" / 300mm 2 pcs.	5706915045253	90	1
10507929	Bi-Metal Hacksaw Blade 3pk (one each 18, 24 & 32TP), 12" / 300mm	5706915079296	150	1
10505897	Bi-Metal Hacksaw Blade 18TPI, 12" / 300mm, 10 pcs.	5706915058970	50	1
10505898	Bi-Metal Hacksaw Blade 24TPI, 12" / 300mm, 10 pcs.	5706915058987	50	1
10505899	Bi-Metal Hacksaw Blade 32TPI, 12" / 300mm, 10 pcs.	5706915058994	50	1
10504520	Bi-Metal Hacksaw Blade 18TPI, 12" / 300mm, 100 pcs.	5706915045208	5	1
10504521	Bi-Metal Hacksaw Blade 24TPI, 12" / 300mm, 100 pcs.	5706915045215	5	1
10504522	Bi-Metal Hacksaw Blade 32TPI, 12" / 300mm, 100 pcs.	5706915045222	5	1
10504530	Junior Hacksaw Wood Blade 14TPI, 6" / 150mm, 10 pcs.	5706915045307	10	1
10504531	Junior Hacksaw Wood Blade 32TPI, 6" / 150mm, 10 pcs.	5706915045314	10	1

HACKSAW FRAMES

The IRWIN® Hacksaw frames are built to meet the professional's demanding needs. The durable IRWIN® frames make cutting quick and easy.



JAB SAW
OPTION

I - 125 HIGH-TENSION HACKSAW (125kg/25,000 PSI)

The IRWIN® heavy-duty hacksaw frame is able to reach over 125kg blade tension to ensure accurate cutting. The soft-touch handle gives professionals a solid and slip-free grip.

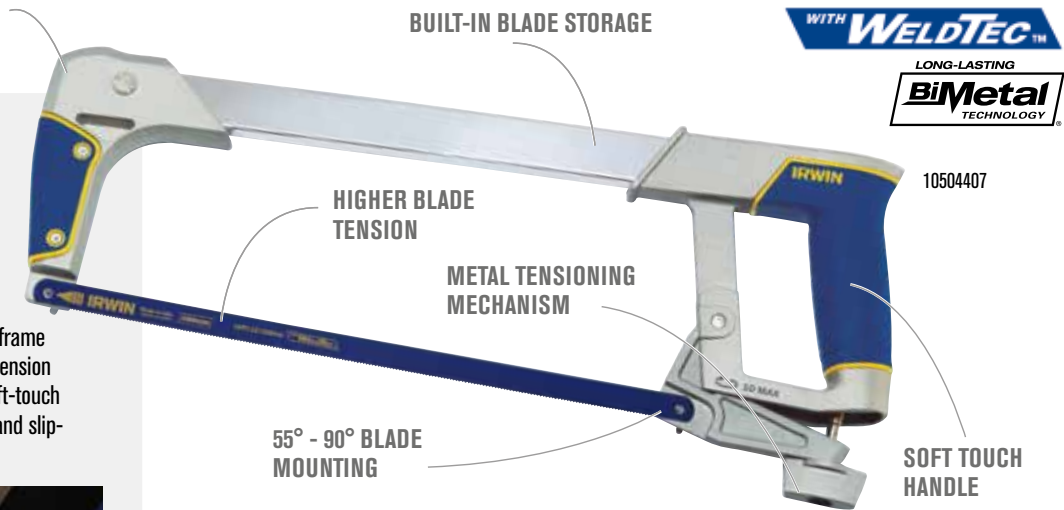

- HIGHER BLADE TENSION**
For straight cuts and prevents blade being released when dropped
- METAL TENSIONING MECHANISM**
For a longer lasting tool
- SOFT TOUCH HANDLE**
Ensure a comfortable sawing grip and prevents slippage
- BUILT-IN BLADE STORAGE**
So spare blades easily accessible
- 55° - 90° BLADE MOUNTING**
For sawing large objects
- JAB SAW OPTION**
For sawing in confined spaces

ITEM NO.	DESCRIPTION	EAN	MASTER PACK	SHELF PACK
10504407	I-125 Hacksaw for 12" / 300mm blades	5706915044072	10	10

I - 75 LOW TENSION HACKSAW (75kg/15,000 PSI)

This lightweight durable full metal frame - tensions up to 15,000 PSI with a full metal tensioning mechanism. 90° to 180° blade mounting is available for sawing large objects.

ITEM NO.	DESCRIPTION	EAN	MASTER PACK	SHELF PACK
10506437	I-75 Low-Tension Hacksaw for 12" / 300mm blades	5706915064377	10	10



10506437

MINI HACKSAW

Ergonomic handle for secure and comfortable cutting. Optimised for work in confined places.

ITEM NO.	DESCRIPTION	EAN	MASTER PACK	SHELF PACK
10504408	Mini Hacksaw, 10" / 250mm blade	5706915044089	60	5



10504408

JUNIOR HACKSAW

Durable metal frame and easy tensioning mechanism allows for higher blade tension and improved cutting. The ergonomic handle delivers comfortable sawing.

ITEM NO.	DESCRIPTION	EAN	MASTER PACK	SHELF PACK
10504409	Junior Hacksaw for 6" / 150mm Blades	5706915044096	60	5



10504409

BOLT CUTTERS

IRWIN® Record® bolt cutters made their debut in 1923. IRWIN® Record® bolt cutters combine specially formulated steel jaws and exacting manufacturing techniques to make a range of cutters that will handle high, low and medium tensile materials of all kinds.

HEAVY-DUTY ARM-ADJUSTED DROP FORGED HANDLES – CENTRE CUT

Designed to withstand the most extreme situations, high-tensile drop-forged and ground steel jaws have also gone through a two-stage heat treatment to significantly increase durability and offer a stable cut capacity. Drop-forged steel handles provide safety and reliability and offer optimal performance for cutting high-tensile material.



TB918H

EACH JAW IS PROGRESSIVELY HEAT TREATED to give a penetrating cutting edge and resilient body
JAWS ARE DROP-FORGED from a specially formulated steel machined to precise specifications
COMPOUND ACTION supplies 80lbs of force for every 1lb applied to the handles
DROP-FORGED steel handles
SAFETY STOPS prevent trapped fingers

ITEM NO.	DESCRIPTION	EAN	MASTER PACK	SHELF PACK
T914H	Arm Adjusted Bolt Cutters 14" / 355mm	0734442089162	10	1
T918H	Arm Adjusted Bolt Cutters 18" / 460mm	0734442087489	10	1
T924H	Arm Adjusted Bolt Cutters 24" / 610mm	0734442134046	4	1
T930H	Arm Adjusted Bolt Cutters 30" / 760mm	0734442092643	2	1
T936H	Arm Adjusted Bolt Cutters 36" / 915mm	0734442092766	2	1
T942H	Arm Adjusted Bolt Cutters 42" / 1070mm	0734442092889	1	1

MEDIUM-DUTY CAM-ADJUSTED DROP FORGED HANDLES – CENTRE CUT

The cam adjusted bolt cutters are perfect for medium duty work on a daily basis. The drop-forged steel handles provide safe and reliable action along with specially formulated and heat-treated induction hardened steel heads.



TBC918H

ITEM NO.	DESCRIPTION	EAN	MASTER PACK	SHELF PACK
TBC914H	Cam Adjusted Bolt Cutters 14" / 355mm	0734442090847	10	1
TBC918H	Cam Adjusted Bolt Cutters 18" / 460mm	0734442092407	10	1
TBC924H	Cam Adjusted Bolt Cutters 24" / 610mm	0734442092520	4	1
TBC930H	Cam Adjusted Bolt Cutters 30" / 760mm	0734442092667	3	1
TBC936H	Cam Adjusted Bolt Cutters 36" / 915mm	0734442092780	2	1

GENERAL PURPOSE CAM-ADJUSTED TUBULAR HANDLES – CENTRE CUT

The cam adjusted high-tensile tubular handled bolt cutter are lightweight and easy to maintain. Great for help around the workshop, farm or garage.



TTBC918

ITEM NO.	DESCRIPTION	EAN	MASTER PACK	SHELF PACK
TTBC914	Cam Adjusted Tubular Handled Bolt Cutters 14" / 355mm	0734442089834	10	1
TTBC918	Cam Adjusted Tubular Handled Bolt Cutters 18" / 460mm	0734442089841	8	1
TTBC924	Cam Adjusted Tubular Handled Bolt Cutters 24" / 610mm	0734442089858	6	1
TTBC930	Cam Adjusted Tubular Handled Bolt Cutters 30" / 760mm	0734442089896	4	1
TTBC936	Cam Adjusted Tubular Handled Bolt Cutters 36" / 915mm	0734442089902	3	1

MEDIUM-DUTY CAM-ADJUST DROP FORGED HANDLES – END CUT

Designed for close cropping low-tensile and non-ferrous materials in confined spaces.



TBC924E

ITEM NO.	DESCRIPTION	EAN	MASTER PACK	SHELF PACK
TBC924E	Cam Adjusted Bolt Cutter -End Cut 24"/610 mm	0734442093008	6	1

MEDIUM-DUTY CABLE CUTTERS

Drop-forged steel heads with long tubular handles for cutting a variety of wire and cable.

ITEM NO.	DESCRIPTION	EAN	MASTER PACK	SHELF PACK
TWC16	Up to 16 mm Wire Rope & 21mm OD Armoured Electric Cable	0734442175704	10	1
TCC26	Up to 26 mm Un-Armoured Copper & Aluminium Cable	0734442176008	10	1



TWC16

REPLACEMENT JAWS - CENTRE CUT

ITEM NO.	DESCRIPTION	EAN	MASTER PACK	SHELF PACK
TJ914H	Replacement Jaw - Center Cut, Fits 14" / 355mm Bolt Cutters	0734442094579	-	1
TJ918H	Replacement Jaw - Center Cut, Fits 18" / 460mm Bolt Cutters	0734442096009	-	1
TJ924H	Replacement Jaw - Center Cut, Fits 24" / 610mm Bolt Cutters	0734442096122	-	1
TJ930H	Replacement Jaw - Center Cut, Fits 30" / 760mm Bolt Cutters	0734442096245	-	1
TJ936H	Replacement Jaw - Center Cut, Fits 36" / 915mm Bolt Cutters	0734442096368	-	1
TJ942H	Replacement Jaw - Center Cut, Fits 42" / 1070mm Bolt Cutters	0734442096481	-	1



TJ918H

REPLACEMENT JAWS - CLIPPER CUT

ITEM NO.	DESCRIPTION	EAN	MASTER PACK	SHELF PACK
TJ918F	Replacement Jaw - Clipper Cut, Fits 18" / 460mm Bolt Cutters	0734442094685	-	1
TJ924F	Replacement Jaw - Clipper Cut, Fits 24" / 610mm Bolt Cutters	0734442094807	-	1
TJ930F	Replacement Jaw - Clipper Cut, Fits 30" / 760mm Bolt Cutters	0734442094920	-	1



TJ918F

REPLACEMENT JAWS - CLIPPER CUT

ITEM NO.	DESCRIPTION	EAN	MASTER PACK	SHELF PACK
TJ924E	Replacement Jaw - End Cut, Fits item TBC924E	0734442097204	-	1



TJ924E

REPLACEMENT STRAP SETS

ITEM NO.	DESCRIPTION	EAN	MASTER PACK	SHELF PACK
T914UEFGT	Replacement Strap Set, Fits 14" / 355mm Bolt Cutters	0734442097938	-	1
T918UEFGT	Replacement Strap Set, Fits 18" / 460mm Bolt Cutters	0734442098058	-	1
T924UEFGT	Replacement Strap Set, Fits 24" / 610mm Bolt Cutters	0734442098652	-	1
T930UEFGT	Replacement Strap Set, Fits 30" / 760mm Bolt Cutters	0734442110057	-	1
T936UEFGT	Replacement Strap Set, Fits 36" / 915mm Bolt Cutters	0734442114857	-	1
T942UEFGT	Replacement Strap Set, Fits 42" / 1070mm Bolt Cutters	0734442108979	-	1



T918UEFGT

FASTENER KITS

ITEM NO.	DESCRIPTION	EAN	MASTER PACK	SHELF PACK
T914KIT	Fastener Kit for item T914H	0734442097945	-	1
T918KIT	Fastener Kit for item T918H	0734442089292	-	1
T924KIT	Fastener Kit for item T924H	0734442098669	-	1
T930KIT	Fastener Kit for item T930H	0734442104773	-	1
T936KIT	Fastener Kit for item T936H	0734442091455	-	1
T942KIT	Fastener Kit for item T942H	0734442108917	-	1
TBC914KIT	Fastener Kit for item TBC914H & TTBC914	0734442090977	-	1
TBC918KIT	Fastener Kit for item TBC918H & TTBC918	0734442090984	-	1
TBC924KIT	Fastener Kit for item TBC924H & TTBC924	0734442169673	-	1
TBC930KIT	Fastener Kit for item TBC930H & TTBC930	0734442010043	-	1
TBC936KIT	Fastener Kit for item TBC936H & TTBC936	0734442101444	-	1

INCLUDES:

- 4 arm adjust screws
- 2 stud strap nuts
- 2 stud strap washers
- 1 handle connecting pin
- 1 handle connecting clip
- 2 handle connecting bolts,
- 2 handle connecting nuts
- 2 arm rivets
- 1 jaw center pin



GILBOW®

SNIPS AND SHEARS

IRWIN® Gilbow® snips and shears have a cutting capability much greater than the strength of the user. The original tin snips were first designed in 1924 and have dominated the sheet metal cutting industry to such an extent that today, snips and shears are referred to as 'Gilbows'.

GENERAL PURPOSE SNIPS



TG24514

UNIQUE NON-SLIP JOINT set and tested for a perfect cut. This should be re-adjusted only after sharpening
DOUBLE, HOLLOW GROUND BLADES reduce friction for easier cutting
DROP-FORGED carbon tool steel handles and blades
SAFETY STOP prevents trapped fingers

ITEM NO.	DESCRIPTION	EAN	MASTER PACK	SHELF PACK
TG2458	General Purpose Snips, 8" / 200mm	0734442188049	36	6
TG24510	General Purpose Snips, 10" / 250mm	0734442188162	36	6
TG24512	General Purpose Snips, 12" / 300mm	0734442188285	36	6
TG24514	General Purpose Snips, 14" / 350mm	0734442188407	36	6

CURVED BLADE SNIPS

Designed to complement the General Purpose range, these snips will make tight radius cuts in a clockwise or anti-clockwise direction.



TG24612

ITEM NO.	DESCRIPTION	EAN	MASTER PACK	SHELF PACK
TG2468	Curved Blade Snips, 8" / 200mm	0734442189008	48	6
TG24610	Curved Blade Snips, 10" / 250mm	0734442189121	48	3
TG24612	Curved Blade Snips, 12" / 300mm	0734442189244	48	3

JEWELLERS' SNIPS

Short-bladed light-duty snips often used by jewellers, silversmiths and model makers.



TG56

ITEM NO.	DESCRIPTION	EAN	MASTER PACK	SHELF PACK
TG56	Jewellers' Snips, 7" / 175mm Straight Blade	0734442190202	24	6
TG056	Jewellers' Snips, 7" / 175mm Curved Blade	0734442187929	24	6

HEAVY-DUTY CRANKED HANDLE SHEARS

These crank-handled shears can be used for off-straight cutting. The G69 is right-hand cranked for working anti-clockwise and the G67 is left-hand cranked for working clockwise.



TG67

ITEM NO.	DESCRIPTION	EAN	MASTER PACK	SHELF PACK
TG67	Heavy-Duty Cranked Handle Snips, 11" / 175mm Left-Handed	0734442189367	36	6
TG69	Heavy-Duty Cranked Handle Snips, 11" / 175mm Right-Handed	0734442189480	36	6
TG691	Heavy-Duty Cranked Handle Snips, 14" / 350mm Right-Handed	0734442189602	36	6

MEDIUM-DUTY STRAIGHT HANDLE SHEARS

Used for straight cutting.



TG950

ITEM NO.	DESCRIPTION	EAN	MASTER PACK	SHELF PACK
TG950	Medium-Duty Straight Handle Snips, 12" / 300mm	0734442189725	36	6
TG69NB	Nut & Bolt for G67, G69, G950, G691	0734442195368	-	1

AVIATION AND OFFSET SNIPS

IRWIN® Aviation and Offset Snips have precision formed blades for a longer cutting life; ergonomically designed over-moulded soft-grips for a perfect balance of comfort and performance in the hand, and a long-life torsion spring for a smooth and consistent cut.

SERRATED LOWER BLADE

INCREASED LENGTH OF CUT

IMPROVED BALANCED WEIGHT DISTRIBUTION

AVIATION SNIPS

Serrated blade grips material for a smoother cut on thin material. Ideal for heating, air conditioning, gutter work and general industrial use.



1. SERRATED LOWER BLADE

For firmer action, smoother cut and no double marked edges

2. PROTOUCH™ GRIPS

Moulded for superior comfort and control, resulting in less hand fatigue/stress

3. INCREASED LENGTH OF CUT

For faster work (3.34cm length of cut)

4. IMPROVED BALANCED WEIGHT DISTRIBUTION

For greater comfort

5. DROP-RESISTANT PUSH-UP LATCH

For easy one-handed use that saves time and increases safety

6. CUT CAPACITY OF 1.19 mm

For sheet metal and 0.84mm stainless steel

ProTouch
GRIPS



10504309N



10504310N



10504311N

ITEM NO.	DESCRIPTION	EAN	MASTER PACK	SHELF PACK
10504309N	Aviation Snip 101, Left and Straight Cut	5706915043099	-	5
10504310N	Aviation Snip 102, Right and Straight Cut	5706915043105	-	5
10504311N	Aviation Snip 103, Straight and Wide Curves	5706915043112	-	5

BULLDOG SNIPS

Short blades designed for more power when notching and trimming thicker material. 225mm long with a 1.9 cm length of cut. Cut capacity of 16g/1.52 mm sheet metal and 18g/1.19 mm stainless steel.

ITEM NO.	DESCRIPTION	EAN	MASTER PACK	SHELF PACK
10504313N	Bulldog Snip 105, Straight and Short Curves	5706915043136	-	5



10504313N



OFFSET SNIPS

For straight or curved cuts. Keeps hands safely above the work surface. 240mm long with a 3.02 cm length of cut. Cut capacity of 18g / 1.19 mm sheet metal and 22g / 0.84 mm stainless steel.



10504315N



10504316N

ITEM NO.	DESCRIPTION	EAN	MASTER PACK	SHELF PACK
10504315N	Offset Snip 20SL, Straight, Angles & Left Curves	5706915043150	-	5
10504316N	Offset Snip 20SR, Straight, Angles & Right Curves	5706915043167	-	5

EXTRA CUT SNIPS

Designed for numerous applications when a long cut in lightweight material is desired. Compound leverage design provides cuts up to 80mm.



10504314N

ITEM NO.	DESCRIPTION	EAN	MASTER PACK	SHELF PACK
10504314N	Extra Cut Snip 304 Cut Straight and Wide Curves	5706915043143	25	5





In 1933, a young man by the name of Hans Schroder set up as a wholesaler in Copenhagen, Denmark. During the first few years he kept his focus on selling general hand tools, but in 1938 he started to also manufacture saws. Amongst his friends and business associates Hans Schroder was known simply as Jack, and before long, the "Jack" name had become synonymous with the production of high quality saws.

IRWIN® Jack® has been at the forefront of many advancements with the development of the market leading Jack® 880 now with upgraded ProTouch™ handle to compliment the recently upgraded universal triple ground tooth technology.

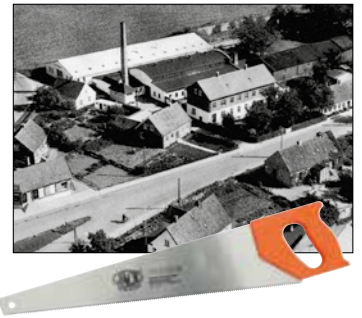

Marples®

At the heart of quality craftsmanship lies the rich heritage of Marples® woodworking tools. Originating in 1828 in Sheffield, England, the Marples® brand has consistently stood for superior performance and ultimate precision in fine woodworking.

Founder William Marples came from a long lineage of master craftsmen in the joinery and edge tool trades, and after serving as an apprentice to his father he established William Marples and Sons Limited. Using only the finest materials Marples® had his name stamped into every product as a sign of his confidence in the quality and craftsmanship of each tool.



HANDSAWS



CHISELS



WOODWORKING TOOLS



PLUS 880 UNIVERSAL HANDSAW



A JACK FOR ALL TRADES

The IRWIN® Jack® PLUS range provides best-in-class handsaws for today's trade professional. With advanced tooth technology and an ergonomic ProTouch™ grip, the PLUS range handsaws are number one for speed and ease and quality of cut. Along with these industry-leading features, the full range utilises a system of colour coded handles for easy selection.



- 1. UNIVERSAL TRIPLE GROUND TEETH**
Patented tooth grind designed to cut 25% faster
Versatile, universal teeth cut most building materials
- 2. STRONG BLADE**
High quality C75 steel is stable and ensures maximum power transfer with every stroke
- 3. PROTOUCH™ GRIP WITH FINGER REST**
With three times more elastomer for maximum soft-feel and control
- 4. OPTIMISED HAND CAPACITY**
Increased space for use with gloves and improved functionality
- 5. INCREASED GRIP CIRCUMFERENCE**
For a sturdy and robust feel
- 6. 90° & 45° ANGLES**
Integrated into handle for easy marking out

25% FASTER*

ProTouch
GRIPS

880 UNIVERSAL HANDSAW

Ever-reliable cutting performance, improved handle design.

ITEM NO.	DESCRIPTION	HANDLE COLOUR	EAN	MASTER PACK	SHELF PACK
10503621	Universal 880TG, 350mm / 14" 8T/9P	Blue/Yellow	5706915936216	-	10
10503622	Universal 880TG, 400mm / 16" 8T/9P	Blue/Yellow	5706915936223	-	10
10503623	Universal 880TG, 450mm / 18" 8T/9P	Blue/Yellow	5706915936230	-	10
10503624	Universal 880TG, 500mm / 20" 8T/9P	Blue/Yellow	5706915936247	-	10
10503625	Universal 880TG, 550mm / 22" 8T/9P	Blue/Yellow	5706915936254	-	10

NEW PROTOUCH GRIP for maximum feel
25% FASTER CUTTING PERFORMANCE*
FULL RANGE of Fine, Universal, Coarse and Coated PLUS Handsaws Available
BLADE LENGTHS 350, 400, 450, 500, 550mm

* vs previous, double ground version





UNIVERSAL COATED

BLADE LENGTH - 550mm



FRICTION PTFE COATING
Gives between 20 to 50% speed improvement (material dependent) when sawing
Offers improved wear-resistance



ITEM NO.	DESCRIPTION	HANDLE COLOUR	EAN	MASTER PACK	SHELF PACK
1909432	Universal Coated 880TG, 550mm / 22" 8T/9P		5706919094325	-	10

COARSE

BLADE LENGTH - 500mm AND 550mm



COARSE TEETH
Patented Tooth Grind
Double Ground
7 Teeth Per Inch



ITEM NO.	DESCRIPTION	HANDLE COLOUR	EAN	MASTER PACK	SHELF PACK
2028296	Crosscut / Coarse 770DG, 500mm / 20" 7T/8P		5706915282962	-	10
10505211	Crosscut / Coarse 770DG, 550mm / 22" 7T/8P		5706915052114	-	10

FINE

BLADE LENGTH - 325mm, 500mm AND 550mm



FINE TEETH
Patented Tooth Grind
Triple Ground
9 Teeth Per Inch
WITH TRIPLE GROUND TEETH*



ITEM NO.	DESCRIPTION	HANDLE COLOUR	EAN	MASTER PACK	SHELF PACK
2028297	Fine 990TG, 500mm / 20" 9T/10P		5706915282979	-	10
10505215	Fine 990TG, 550mm / 22" 9T/10P		5706915052152	-	10
10503632	Ultra Fine 990, 325mm / 13" 12T/13P		5706915936322	-	10

*From April 2020

XPERT HANDSAWS

XPERT

The XPERT saw range takes wood cutting to new levels of comfort and performance - with a specific saw for every material and application.



Triple-Ground Teeth (TGT). This technology has been developed in collaboration with the research centre of the University of Newcastle. The TGT logo is the mark of quality for the IRWIN® Jack® tooth design.



10505540

10505538



10505542



10505550



XPERT HANDSAWS

ITEM NO.	DESCRIPTION	HANDLE COLOUR	EAN	MASTER PACK	SHELF PACK
10505538	Universal Toolbox 15" / 375mm 8T/9P	Blue/Yellow	5706915055382	-	10
10505539	Universal 18" / 450mm 8T/9P	Blue/Yellow	5706915055399	-	4
10505540	Universal 20" / 500mm 8T/9P	Blue/Yellow	5706915055405	-	4
10505541	Universal 22" / 550mm 8T/9P	Blue/Yellow	5706915055412	-	4
10505555	Fine Toolbox 15" / 375mm 10T/11P	Blue/Yellow	5706915055559	-	10
10505556	Fine 20" / 500mm 10T/11P	Blue/Yellow	5706915055566	-	4
10505543	Fine 22" / 550mm 10T/11P	Blue/Yellow	5706915055436	-	4
10505542	Coarse with Gullets 22" / 550mm 8T/9P	Blue/Yellow	5706915055429	-	4
10503530	Coarse 20" / 500mm 3,5T/4P	Blue/Yellow	5715110475802	-	4
10503531	Coarse 24" / 600mm 3,5T/4P	Blue/Yellow	5715110427191	-	4
10505548	Light Concrete Hardpoint Teeth 28" / 700mm	Blue/Yellow	5706915055481	-	4
10505549	Light Concrete 1/2 Carbide Tipped 28" / 700mm	Blue/Yellow	5706915055498	-	4
10505550	Light Concrete FULL Carbide Tipped 28" / 700mm	Blue/Yellow	5706915055504	-	4

TRIPLE-GROUND TEETH for ultimate cutting performance
HIGH QUALITY C75 STEEL, 1mm RIGID BLADE for maximum stability and power transfer
HARD POINT TEETH stay sharp longer for extended life
WATER BASED LACQUER gives four times better rust protection than traditional lacquer
SOFT-GRIP HANDLE with finger guide for comfort in prolonged use
DEEP GULETS for enhanced performance and greater volume removal of waste material (Coarse saw only)
FINE NOSE TEETH for easy start (Universal and Toolbox Saw only)

XPERT COATED HANDSAWS

The Xpert range of low-friction PTFE coated handsaws from IRWIN® give between 20 to 50% speed improvement (material dependent) when sawing and also offer improved wear-resistance.

ITEM NO.	DESCRIPTION	HANDLE COLOUR	EAN	MASTER PACK	SHELF PACK
10505544	Universal Toolbox PTFE 15"/375mm 8T/9P	Blue/Yellow	5706915055443	-	10
10505545	Universal PTFE 20"/500mm 8T/9P	Blue/Yellow	5706915055450	-	4
10505546	Universal PTFE 22"/550mm 8T/9P	Blue/Yellow	5706915055467	-	4
10505602	Fine PTFE 20"/500mm 10T/11P	Blue/Yellow	5706915056020	-	4
10505603	Fine PTFE 22"/550mm 10T/11P	Blue/Yellow	5706915056037	-	4
10505547	Coarse with gullets PTFE 22"/550mm 8T/9P	Blue/Yellow	5706915055474	-	4



10505545

XPERT BOWSAWS

IRWIN® offers the complete range of bowsaws and replacement blades for pruning and garden work. Select from hard point and precision filed blades that give outstanding cutting performance, whether it's trimming storm-damaged trees, pruning shrubs, bushes or cutting firewood.

ITEM NO.	DESCRIPTION	EAN	MASTER PACK	SHELF PACK
FRAMES				
TXP1624533000	Bowsaw - Green Wood 21" / 533 mm	5706915000269	-	5
TXP1124610000	Bowsaw - Green Wood 24" / 610 mm	5706915000207	-	5
TXP1124762000	Bowsaw - Green Wood 30" / 762 mm	5706915000221	-	5
BLADES				
TXP3011300000	Bowsaw Blade - Dry Wood 12" / 300 mm	5715110480066	-	10
TXP3020533000	Bowsaw Blade - Dry Wood 21" / 533 mm	5715110480189	-	10
TXP3020610000	Bowsaw Blade - Dry Wood 24" / 610 mm	5715110480219	-	10
TXP3020762000	Bowsaw Blade - Dry Wood 30" / 762 mm	5715110480240	-	10
TXP3024533000	Bowsaw Blade - Green Wood 21" / 533 mm	5715110480271	-	10
TXP3024610000	Bowsaw Blade - Green Wood 24" / 610 mm	5715110480332	-	10
TXP3024762000	Bowsaw Blade - Green Wood 30" / 762 mm	5715110480301	-	10



TXP1124762000



TXP3011300000



TXP3020533000



TXP3024533000





EVO HANDSAWS

The unique handle-to-blade relationship of the EVO handsaw overcomes traditional design limitations and maximises how the user interacts with the handsaw. With an innovative tooth design and superior ergonomics, the holistic product design optimises handle position (height and angle) against the tooth line. EVO covers virtually all user needs.



- HIGH ANGLED NOSE** increases blade stability
- HARD POINT TEETH (HP)** stay sharp 6-8 times longer than non-hardened teeth
- OPTIMISED TOOTH DESIGN & SET** provides maximum versatility, Speed of cut & quality of cut
- HIGH QUALITY C75 STEEL BLADE** ensures maximum stability and power transfer
- OPTIMISED PRODUCT DESIGN** for universal usage and highest versatility
- MAXIMUM BLADE USAGE** allows up to 100% blade usage
- FLUSH CUTTING** to cut off at surface level
- COMFORT GRIP** light and strong ultrasonic welded soft-grip handle for maximum grip and comfort
- 90° & 45°** for marking out
- FINGER-REST** for maximum control



ITEM NO.	DESCRIPTION	HANDLE COLOUR	EAN	MASTER PACK	SHELF PACK
10507858	EVO Handsaw Universal, 525mm 10T/11P		5706915078589	-	10
10507860	EVO Handsaw Universal - Short, 425mm 10T/11P		5706915078602	-	10
1965487	EVO Handsaw Universal Coated 485mm 10T/11P		5706919654871	-	10

SPECIALTY SAWS

IRWIN® Specialty saws help construction professionals effectively carry out trade specific jobs like cutting openings in gypsum board.



10503533

10503534



10505705



T106150



10503532



10505163



10505164



10505165



TNA2059343000



TXP1211300000

ITEM NO.	DESCRIPTION	EAN	MASTER PACK	SHELF PACK
10505705	ProTouch Job Saw, 7T/8P	5706915057058	24	4
T106150	Standard Job Saw, 7T/8P	5715110421601	-	20
10503532	Keyhole/ Pad Saw, 12"/300mm	5706915035322	-	4
10503533	Floorboard/Veneer, 13"/325mm	5706915035339	-	4
10507424	Tenon, 10"/250mm 12T/13P	5706915074246	-	4
10503534	Tenon, 12"/300mm 12T/13P	5706915035346	-	4
10503535	Tenon, 14"/350mm 12T/13P	5706915035353	-	4

PULL SAWS

IRWIN® Pull Saws are rapidly becoming an essential tool for both the specialist woodworker and for carpenters and re-modellers. The products offers a very thin blade that is flexible for flush and difficult cuts.

ITEM NO.	DESCRIPTION	EAN	MASTER PACK	SHELF PACK
10505162	Pull Saw Carpenter 12"/300mm, 14TPI	5706915051629	-	4
10505163	Pull Saw Extra Fine Cut (with spine), 19TPI	5706915051636	-	4
10505164	Pull Saw Double Edge (rip/cross-cut), 7/17TPI	5706915051643	-	4
10505165	Pull Saw Mini Dovetail/ Detail Saw, 22TPI	5706915051650	-	4

PRUNING SAWS

ITEM NO.	DESCRIPTION	EAN	MASTER PACK	SHELF PACK
TNA2059343000	Pruning Saw - Straight	5715110421632	-	6
TNA2072330000	Pruning Saw - Curved	5715110421663	-	6

COMBI SAW

IRWIN® Jack® Combi Saw comes with a wood cutting bowsaw blade and a Bi-Metal cutting hacksaw blade making this tool universal for all cutting applications.

ITEM NO.	DESCRIPTION	EAN	MASTER PACK	SHELF PACK
TXP1211300000	Combi Saw, 12"/300 mm	5706915000122	-	10



Marples®

CHISELS

IRWIN® woodworking tools embody a long tradition of craftsmanship and Marples® chisels remain the finest on the market, recognised by professionals as setting the standard for all others. With many unique features developed through continuing innovation, our comprehensive range of tough, dependable chisels will tackle the most intricate or demanding job effortlessly.

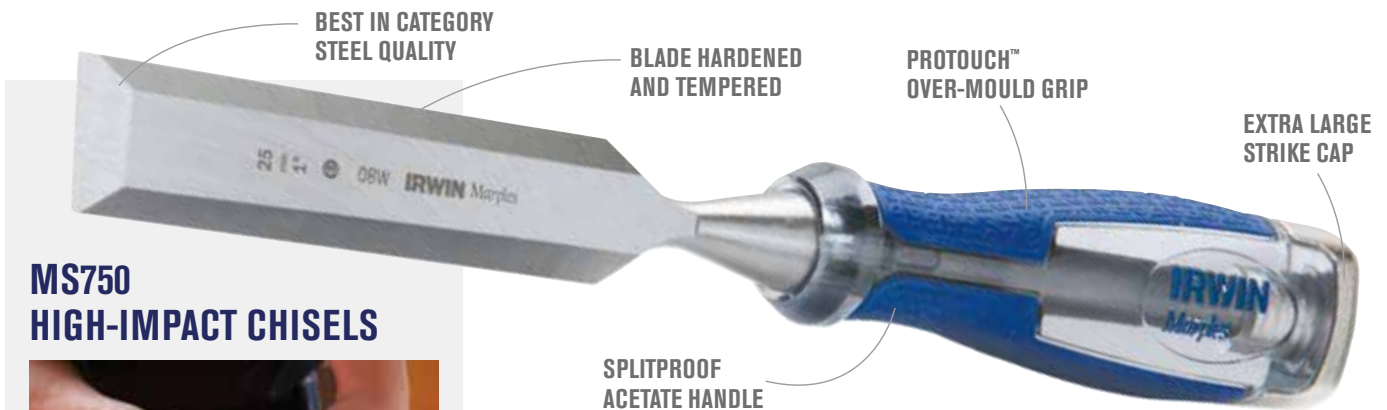

MS750 HIGH-IMPACT CHISELS



- 1. BEST IN CATEGORY STEEL QUALITY**
For improved sharpness and edge retention
- 2. BLADE HARDENED AND TEMPERED**
For long chisel life
- 3. FULLY FORGED STEEL CORE**
To better transfer energy from handle to blade
- 4. PROTOUCH™ OVER-MOULD GRIP**
For added comfort
- 5. SPLITPROOF ACETATE HANDLE**
For superior durability
- 6. EXTRA LARGE STRIKE CAP**
For use with hammers at different angles

MS750 SINGLES



10501685



10503733

ITEM NO.	DESCRIPTION	EAN	MASTER PACK	SHELF PACK
10501671	MS750, 3mm	0734442201250	48	4
10501673	MS750, 6mm	0734442201151	48	4
10501674	MS750, 8mm	5706915016741	48	4
10501675	MS750, 10mm	0734442201168	48	4
10501676	MS750, 12mm	5706915016765	48	4
10501678	MS750, 14mm	5706915016789	48	4
10501679	MS750, 15mm	5706915016796	48	4
10501680	MS750, 16mm	0734442201267	48	4
10501681	MS750, 18mm	5706915016819	48	4
10501683	MS750, 20mm	5706915016833	48	4
10501684	MS750, 22mm	5706915016840	48	4
10501685	MS750, 25mm	0734442201199	48	4
10501686	MS750, 26mm	5706915016864	48	4
10501687	MS750, 28mm	5706915016871	48	4
10501688	MS750, 30mm	5706915016888	48	4
10501689	MS750, 32mm	0734442201205	48	4
10501690	MS750, 35mm	5706915016901	48	4
10501691	MS750, 38mm	0734442201212	24	2
10501693	MS750, 51mm	0734442201274	24	2

MS750 SETS



10504711

ITEM NO.	DESCRIPTION	EAN	MASTER PACK	SHELF PACK
10504711	MS750, 3 pcs, 6, 12, 20 mm, Wallet	5706915047110	16	4
10504712	MS750, 3 pcs, 10, 15, 20 mm, Wallet	5706915047127	16	4
10503733	MS750, 6 pcs, 6, 10, 15, 20, 25, 35 mm, in Wooden Box	5706915037333	5	1

MS751 FIRMER CHISEL

The MS751 Firmer chisel has a blade with a rectangular cross-section. This means that it is stronger and can be used for heavier work and cuts on a front edge.



10501768

ITEM NO.	DESCRIPTION	EAN	MASTER PACK	SHELF PACK
10501768	MS751, 1-1/8" / 28mm	5706915017687	48	4

MS500 ALL-PURPOSE CHISELS WITH STRIKING CAP



10501708

MS500 SINGLES

ITEM NO.	DESCRIPTION	EAN	MASTER PACK	SHELF PACK
10501698	MS500, 6mm	5706915016987	48	4
10501699	MS500, 8mm	5706915016994	48	4
10501700	MS500, 10mm	5706915017007	48	4
10501701	MS500, 12mm	5706915017014	48	4
10501703	MS500, 14mm	5706915017038	48	4
10501704	MS500, 15mm	5706915017045	48	4
10501705	MS500, 16mm	5706915017052	48	4
10503666	MS500, 18mm	5706915036664	48	4
10501707	MS500, 20mm	5706915017076	48	4
10503667	MS500, 22mm	5706915036671	48	4
10501708	MS500, 25mm	5706915017083	48	4
10501709	MS500, 26mm	5706915017090	48	4
10503668	MS500, 28mm	5706915036688	48	4
10501710	MS500, 30mm	5706915017106	48	4
10503669	MS500, 32mm	5706915036695	48	4
10503423	MS500, 35mm	5706915034233	48	4
10503670	MS500, 38mm	5706915036701	24	2
10503425	MS500, 51mm	5706915034257	24	2

BEST IN CATEGORY STEEL QUALITY
for improved sharpness and edge retention

BLADE HARDENED AND TEMPERED
for long chisel life

PROTOUCH GRIP for added comfort

DURABLE HANDLE to withstand tradesmen abuse

LARGE STRIKE CAP to withstand hammer impacts



MS500 SETS

ITEM NO.	DESCRIPTION	EAN	MASTER PACK	SHELF PACK
10503835	MS500, 3 pcs, 6, 12, 20mm, Wallet	5706915038354	16	4
10503836	MS500, 3 pcs, 10, 15, 20mm, Wallet	5706915038361	16	4
10503429	MS500, 5 pcs, 6, 10, 15, 20, 25, Wallet	5706915034295	16	8
10503876	MS500, 5 pcs, 6, 10, 16, 20, 26, Wallet	5706915038767	16	8
10503431	MS500, 6 pcs, 6, 10, 12, 16, 20, 26mm in Wooden Box	5706915034318	5	1
10503541	MS500, 6 pcs, 6, 10, 15, 20, 25, 35mm in Wooden Box	5706915035414	5	1



10503835



10503429



10503431



Marples®

M444 BLUE-CHIP BEVEL EDGE CHISELS



M444 SINGLES

BEST IN CATEGORY STEEL QUALITY for improved sharpness and edge retention
BLADE HARDENED AND TEMPERED for long chisel life
CONTOURED HANDLE provides added control
STRONG HANDLE for use with hand or mallet

ITEM NO.	DESCRIPTION	EAN	MASTER PACK	SHELF PACK
TM44418	M444, 3mm	0734442196440	24	6
TM44414	M444, 6mm	0734442196563	24	6
TM44438	M444, 10mm	0734442196686	24	6
TM44412	M444, 13mm	0734442196808	24	6
TM44458	M444, 16mm	0734442196921	24	6
TM44434	M444, 19mm	0734442197041	24	6
TM4441	M444, 25mm	0734442197164	24	6
TM444114	M444, 32mm	0734442197287	24	6
TM444112	M444, 38mm	0734442197409	24	6
TM4442	M444, 51mm	0734442201960	24	6

M444 SETS



TM444S6

ITEM NO.	DESCRIPTION	EAN	MASTER PACK	SHELF PACK
TM444S3	M444, 3 pcs Set - 13, 19, 25mm in clamshell	0734442197508	16	4
TM444S4	M444, 4 pcs Set - 6, 13, 19, 25mm in clamshell	0734442197522	16	4
TM444S5	M444, 5 pcs Set - 6, 10, 13, 19, 25mm in clamshell	0734442197645	16	4
TM444S6	M444, 6 pcs Set - 6, 10, 13, 19, 25, 32mm in wooden box	0734442197652	5	1



TM444S3



TM444S4



TM444S5

CHISEL SHARPENING SET



ITEM NO.	DESCRIPTION	EAN	MASTER PACK	SHELF PACK
10507932	3 pcs Sharpening Set includes Stone, Guide and Oil	5706915079326	16	4

SQUARES AND SLIDING BEVELS

Sliding bevels are precision tools and are used for checking the accuracy and marking of angles. Tri Squares are designed to check and mark out 90° angles.

TRI & MITRE SQUARES - METRIC

ITEM NO.	DESCRIPTION	EAN	MASTER PACK	SHELF PACK
10503543	Tri & Mitre Square 250mm	5706915035438	-	4
10503544	Tri & Mitre Square 300mm	5706915035445	-	4
10503545	Tri & Mitre Square 350mm	5706915035452	-	4

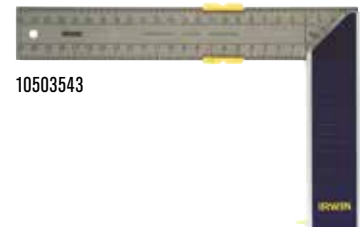

10503543

TRI & MITRE SQUARES - IMPERIAL

ITEM NO.	DESCRIPTION	EAN	MASTER PACK	SHELF PACK
TM22006	Tri Square with Brass Plate 6"	0734442231004	36	6
TM220012	Tri Square 12"	0734442231240	36	6
TMR22089	Tri Square 9"	0734442231486	48	6
TM22210	Mitre Square 10"	0734442231608	36	1



SLIDING BEVELS - METRIC

ITEM NO.	DESCRIPTION	EAN	MASTER PACK	SHELF PACK
10503546	Sliding Bevel 250mm	5706915035469	-	4
10503547	Sliding Bevel 300mm	5706915035476	-	4



10503546

SLIDING BEVELS - IMPERIAL

ITEM NO.	DESCRIPTION	EAN	MASTER PACK	SHELF PACK
TM2226	Sliding Bevel - Brass & Rosewood, 9"	0734442231844	48	4
TM22261012	Sliding Bevel - Brass & Rosewood, 10-1/2"	0734442071167	48	4



TM2226

GENERAL WOODWORKING TOOLS

These tools are an essential part of any workshop or toolbox. They all contribute to the final fit of the timber to ensure the highest quality finish.

BRADAWLS

ITEM NO.	DESCRIPTION	EAN	MASTER PACK	SHELF PACK
TM1838W	Bradawl Wooden Handled	0734442234722	72	12



TM1838W

MORTICE, MARKING AND CUTTING GAUGES

ITEM NO.	DESCRIPTION	EAN	MASTER PACK	SHELF PACK
TM2153	Mortice & Marking Gauge	0734442232322	24	4
TM2154	Mortice & Marking Gauge with thumbscrew slide	0734442232445	12	1
TMR2049	Marking Gauge	0734442231967	48	4
TM2083	Cutting Gauge	0734442232209	24	4



TM2153

CABINET SCRAPERS

These versatile tools are used for shaping and finishing work.

ITEM NO.	DESCRIPTION	EAN	MASTER PACK	SHELF PACK
TM2450	Cabinet Scraper, 5" x 2-1/2" / 125mm x 64mm	0734442235309	-	6
TM2451	Cabinet Scraper, 6" x 3" / 150mm x 75mm	0734442235316	-	6



TM2450



PLANES & PLANE CUTTERS

IRWIN® Record® bring decades of experience, well proven design and advanced production techniques to produce this fine range of woodworking planes and cutters.

BENCH PLANES

Smoothing Plane used for smoothing and final finishing. Jack planes are used for the preliminary squaring of rough timber, and are the general workhorses for stock removal. Fore or jointer planes are used for removing the roughness and unevenness on long surfaces prior to smoothing.



1. HIGH-QUALITY

Cast grey iron body with precision machined base

2. RAZOR SHARP

Carbon steel cutting iron

3. ROBUST LEVER CAP

Has three pressure points and brass locking nut for secure location of the cutting iron

4. FINE ADJUSTMENT

Is controlled by a brass adjusting nut and lateral adjusting lever



ITEM NO.	DESCRIPTION	EAN	MASTER PACK	SHELF PACK
T04	Smoothing Plane, 9-3/4" - 2" / 50mm, Wooden Handle	0734442053408	24	1
TSP4	Smoothing Plane, 9-3/4" - 2" / 50mm, Plastic Handle	0734442165729	48	4
T05	Jack Plane, 14" - 2" / 50mm, Wooden Handle	0734442536482	24	1
TSP5	Jack Plane, 14" - 2" / 50mm, Plastic Handle	0734442165910	48	4
T07	Jointer Plane, 22" - 2-3/8" / 60mm - length 550mm, Wooden Handle	0734442054009	12	1

REBATE PLANE

Rebate plane has two cutter positions, one for normal rebating work and a forward position for planing into corners and difficult positions.



ITEM NO.	DESCRIPTION	EAN	MASTER PACK	SHELF PACK
T778	Rebate Plane, Length 8-1/2" - Cuts Rebates up to 1-1/2" / 38mm	0734442559252	12	1

BLOCK PLANES

Block planes are fully adjustable for the depth of cut with mouth adjustments for coarse or fine work. Low angle block plane is specially made to deal with plastic, laminates, and other man-made materials, besides wood.



ITEM NO.	DESCRIPTION	EAN	MASTER PACK	SHELF PACK
T06012	Block Plane, 6" (42mm) - 1-5/8" 12-1/2° - 20° low angle	0734442552086	24	4
T0912	Block Plane, 6" (42mm) - 1-5/8" 12-1/2°	0734442548430	24	4

SPOKESHAVES

The spokeshave is used for chamfering and shaping - flat-faced for convex surfaces and round-faced for concave surfaces.



ITEM NO.	DESCRIPTION	EAN	MASTER PACK	SHELF PACK
TA151	Spokeshave, Flatface Length 10" / 54mm	0734442056164	24	4
TA151R	Spokeshave, Roundface Length 10" / 54mm	0734442056287	24	4

REPLACEMENT PLANE CUTTERS



ITEM NO.	DESCRIPTION	EAN	MASTER PACK	SHELF PACK
TSI2	Plane Cutter, 2" / 50mm for 04, 05, SP4 & SP5	0734442056522	24	6
TSI238	Plane Cutter, 2-3/8" / 60mm for 06, 07	0734442056645	24	6
T0220D	Plane Cutter, 2-3/8" / 46mm for 09-1/2 & 060-1/2	0734442057963	24	1
T778D	Plane Cutter, for 778	0734442058809	24	1
TA151B	Spokeshave Cutter, 2-1/8" / 54mm	0734442058922	24	1



QUICK-GRIP®

In 1986 Joe Sorensen, an air boat builder in Nebraska, USA was looking for a better way to hold down his steel panels as the clamps he was using twisted the thin steel as he worked.

With a good idea for a new style of clamping, the concept for a pistol grip one-handed bar clamp was born. This revolutionary tool was quickly patented and brought to market in 1989 with a full line of clamps under the QUICK-GRIP® brand name. The line was later extended from the Original clamp to the Micro, Mini, Handi, Quick-Change, and more recently the XP clamp.

Since the launch, IRWIN® Quick-Grip® has become the world leader in one-handed bar clamps and is the industry standard which has changed the way tradespeople do their jobs, greatly improving their ability and efficiency on the job.



Record®

Originally established in 1898 in the South Yorkshire city of Sheffield in the UK. The Record Tools Factory was swiftly able to make a long lasting contribution to the worldwide reputation of the region for the manufacture of high quality steel and castings.

The Record® brand name was introduced in 1909 and by the 1920's the product range had expanded into Vices, Planes, Clamps and Pipe Wrenches enabling the business to grow rapidly in the UK and many overseas markets.

Today, IRWIN® Record® continues excelling by sticking to the traditional values set by its founders, producing tools that are highly valued amongst professional users for quality and durability that remains strong today.



QUICK CLAMPS



STEEL CLAMPS



VICES

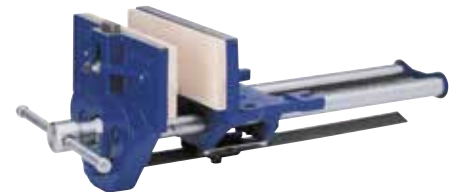

INTRODUCING THE NEXT GENERATION IN CLAMPING TOOLS

The new IRWIN® QUICK-GRIP® One-Handed Bar Clamp range allows end-users to be even more productive on the job. The new heavy-duty and medium-duty clamps feature a Quick-Change™ button for fast conversion to a spreader and for ease-of-use with a new line of One-Handed Bar Clamp Accessories.

These new IRWIN® QUICK-GRIP® One-Handed Bar Clamp Accessories provide added versatility and functionality to one-handed bar clamps—allowing users to DO MORE WITH QUICK-GRIP™.

HEAVY-DUTY ONE-HANDED BAR CLAMPS

NEW QUICK-CHANGE™ BUTTON

HEAVY-DUTY ONE-HANDED BAR CLAMPS

The IRWIN® QUICK-GRIP® Heavy-Duty One Handed Bar Clamp evenly distributes up to 272kg (600 lbs.) of sustained clamping pressure and is one of the top performing One-Handed Bar Clamps available. Ideal for heavy-duty applications such as installation, demolition and rough glue-up.

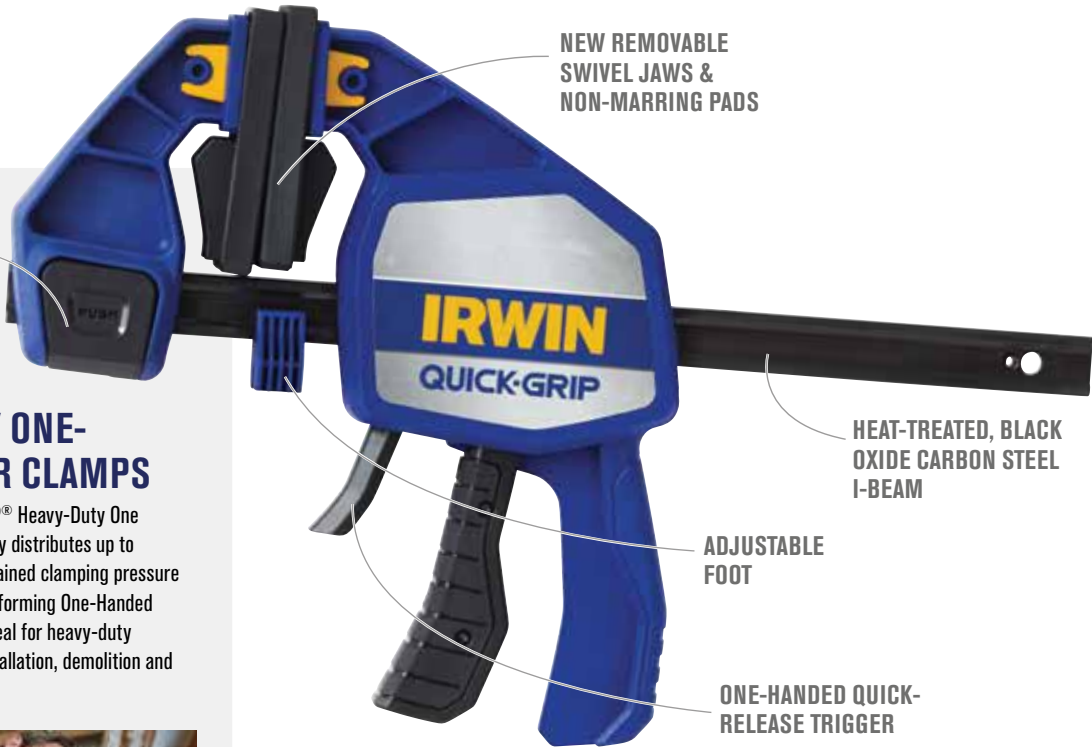

NEW REMOVABLE SWIVEL JAWS & NON-MARRING PADS

HEAT-TREATED, BLACK OXIDE CARBON STEEL I-BEAM

ADJUSTABLE FOOT

ONE-HANDED QUICK-RELEASE TRIGGER

- 1. NEW QUICK-CHANGE™ BUTTON**
Provides easy removal of jaws for accessory installation or conversion to a spreader
- 2. NEW REMOVABLE SWIVEL JAWS & NON-MARRING PADS**
Full-faced pads deliver even distribution of clamping force
- 3. ONE-HANDED QUICK-RELEASE TRIGGER**
New grip and trigger design provides simple, one-handed operation
- 4. HEAT-TREATED, BLACK OXIDE CARBON STEEL I-BEAM**
Support added pressure with less bend and flex for superior durability
- 5. ADJUSTABLE FOOT**
Provides added support allowing clamp to sit upright on table or work surface

272 kg

SUSTAINED CLAMPING FORCE

ITEM NO.	DESCRIPTION	SPREADING CAPACITY	THROAT DEPTH	EAN	MASTER PACK	SHELF PACK
10505942	150mm (6") Heavy-Duty Bar Clamp/Spreader	235mm - 378mm 9-1/4" - 14-7/8"	92mm / 3-5/8"	5706915059427	-	2
10505943	300mm (12") Heavy-Duty Bar Clamp/Spreader	235mm - 530mm 9-1/4" - 20-7/8"	92mm / 3-5/8"	5706915059434	-	2
10505944	450mm (18") Heavy-Duty Bar Clamp/Spreader	235mm - 683mm 9-1/4" - 26-7/8"	92mm / 3-5/8"	5706915059441	-	2
10505945	600mm (24") Heavy-Duty Bar Clamp/Spreader	235mm - 835mm 9-1/4" - 32-7/8"	92mm / 3-5/8"	5706915059458	-	2
10505946	900mm (36") Heavy-Duty Bar Clamp/Spreader	235mm - 1140mm 9-1/4" - 44-7/8"	92mm / 3-5/8"	5706915059465	-	2
10505947	1250mm (50") Heavy-Duty Bar Clamp/Spreader	235mm - 1496mm 9-1/4" - 58-7/8"	92mm / 3-5/8"	5706915059472	-	2



10505942

QUICK-GRIP®

MEDIUM-DUTY ONE-HANDED BAR CLAMPS

NEW QUICK-CHANGE™ BUTTON

MEDIUM-DUTY ONE-HANDED BAR CLAMPS

The IRWIN® QUICK-GRIP® Medium-Duty One-Handed Bar Clamp evenly distributes up to 136kg (300 lbs) of sustained clamping force. Ideal for temporary hold-down, quick clamping applications



NEW REMOVABLE SWIVEL JAWS & NON-MARRING PADS

HEAT-TREATED, BLACK OXIDE CARBON STEEL I-BEAM

ONE-HANDED QUICK-RELEASE TRIGGER

- 1. QUICK-CHANGE™ BUTTON**
Provides easy removal of jaws for accessory installation or conversion to a spreader
- 2. NEW REMOVABLE SWIVEL JAWS & NON-MARRING PADS**
Full-faced pads deliver even distribution of clamping force
- 3. ONE-HANDED QUICK-RELEASE TRIGGER**
New grip and trigger design provides simple, one-handed operation
- 4. HEAT-TREATED, BLACK OXIDE CARBON STEEL I-BEAM**
Support added pressure with less bend and flex for superior durability

136 kg
SUSTAINED CLAMPING FORCE



T506QCEL7

ITEM NO.	DESCRIPTION	SPREADING CAPACITY	THROAT DEPTH	EAN	MASTER PACK	SHELF PACK
T506QCEL7	150mm (6") Medium-Duty Bar Clamp/Spreader	200mm - 340mm 7-7/8" - 13-3/8"	81 mm / 3-3/16"	5706915000061	-	5
T512QCEL7	300mm (12") Medium-Duty Bar Clamp/Spreader	200mm - 590mm 7-7/8" - 19-3/8"	81 mm / 3-3/16"	5706915000078	-	5
T518QCEL7	450mm (18") Medium-Duty Bar Clamp/Spreader	200mm - 645mm 7-7/8" - 25-3/8"	81 mm / 3-3/16"	5706915000085	-	5
T524QCEL7	600mm (24") Medium-Duty Bar Clamp/Spreader	200mm - 795mm 7-7/8" - 31-3/8"	81 mm / 3-3/16"	5706915000092	-	5
T536QCEL7	900mm (36") Medium-Duty Bar Clamp/Spreader	200mm - 1120mm 7-7/8" - 43-3/8"	81 mm / 3-3/16"	5706915000108	-	5

MINI ONE-HANDED BAR CLAMP

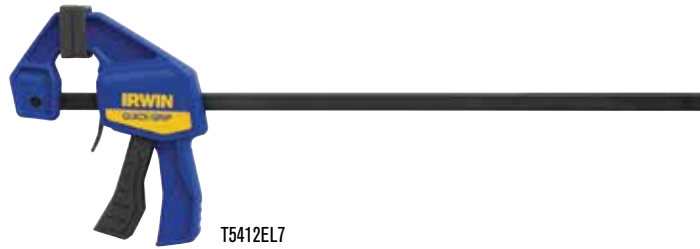

T5412EL7

ITEM NO.	DESCRIPTION	THROAT DEPTH	EAN	MASTER PACK	SHELF PACK
T546EL7	150mm (6") Mini Clamp	2-7/16" / 62mm	5715110790585	-	5
T5462EL7	150mm (6") Mini Clamp - 2 Pack	2-7/16" / 62mm	5715110790592	-	5
T5412EL7	300mm (12") Mini Clamp	2-7/16" / 62mm	5715110790622	-	5
T54122EL7	300mm (12") Mini Clamp - 2 Pack	2-7/16" / 62mm	5715110790639	-	5

EVENLY DISTRIBUTES UP TO 63kg (140 lbs.) of sustained clamping force
IDEAL FOR LIGHT-DUTY APPLICATIONS like woodworking and a variety of smaller projects
NON-MARRING FULL-FACE PADS protect work surfaces
ONE-HANDED QUICK-RELEASE™ TRIGGER

MICRO ONE-HANDED BAR CLAMP



T53006EL7

ITEM NO.	DESCRIPTION	THROAT DEPTH	EAN	MASTER PACK	SHELF PACK
T53006EL7	115mm (4.5") Micro Clamp	1-3/16" / 30mm	5715110790547	-	10
T530062EL7	115mm (4.5") Micro Clamp - 2 Pack	1-3/16" / 30mm	5715110801021	-	5

SPECIALLY DESIGNED for home, craft and hobby use providing 15kg (35 lbs.) of clamping pressure
IDEAL FOR DELICATE WORK requiring light clamping pressure
NON-MARRING FULL-FACE PADS protect work surfaces
ONE-HANDED QUICK-RELEASE™ TRIGGER

HANDI CLAMPS

Strong ratcheting mechanism provides variable clamping pressure 20kg (44 lbs). Quick-Release trigger allows for fast and easy positioning and release. The ideal clamp for jobs in workshop, house and garden. Specially designed jaws hold odd-shaped workpieces.

ITEM NO.	DESCRIPTION	THROAT DEPTH	EAN	MASTER PACK	SHELF PACK
T59100ECD	38mm (1-1/4") Handi Clamp	1-1/2" / 38mm	0038548591001	-	20
T59200ECD	50mm (2") Handi Clamp	2" / 50mm	0038548592008	-	12
T59400ECD	100mm (4") Handi Clamp	4" / 100mm	0038548594002	-	10



T59200ECD

SPRING CLAMPS

High-tech resin construction provides strength and durability. Best for simple and convenient light clamping crafts.

ITEM NO.	DESCRIPTION	THROAT DEPTH	EAN	MASTER PACK	SHELF PACK
T58100EL7	25mm (1") Spring Clamp	1-1/2" / 38mm	0038548581019	50	10
T58200EL7	50mm (2") Spring Clamp	2" / 50mm	0038548582016	50	10
T58300EL7	75mm (3") Spring Clamp	3" / 75mm	0038548582016	25	5



T58200EL7

REPLACEMENT PADS

ITEM NO.	DESCRIPTION	EAN	MASTER PACK	SHELF PACK
1826576	XP Pads, 2 per Pack (Previous Model HD Clamp)	0038548998640	-	5
1826577	Quick-Change Pads, 2 per Pack (Previous Model MD Clamp)	0038548998657	-	5
1826578	Mini Replacement Pads, 4 per Pack	0038548998664	-	5
1826579	Handi Clamp Replacement Pads, 6 per Pack	0038548998671	-	5

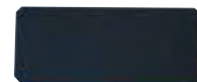

1826576



1826577



QUICK-GRIP®

ONE-HANDED BAR CLAMP ACCESSORIES

The new IRWIN® QUICK-GRIP® One-Handed Bar Clamps are designed to be compatible with the new line of One-Handed Bar Clamp Accessories. The chart below outlines which accessories fit which of the newly designed clamps and which accessories can also be used with the previous generation of IRWIN® QUICK-GRIP® One-Handed Bar Clamps.



Edge Clamping



Wider Clamping Pressure



Corner Clamping



Table Clamping

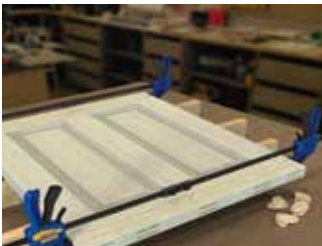

Coupling (Medium-Duty)



Coupling (Heavy-Duty)



Deck Building



Parallel Clamping

EDGE CLAMP



1988919

ITEM NO.	DESCRIPTION	APPLICATION INFORMATION	EAN	MASTER PACK	SHELF PACK
1988919	Edge Clamp	Converts One-Handed Bar Clamp into an edge clamp for easy clamping of trim and edging	5706919889198	40	5

COUPLERS



1988920

1988931

ITEM NO.	DESCRIPTION	APPLICATION INFORMATION	EAN	MASTER PACK	SHELF PACK
1988920	Medium-Duty Clamp Coupler	Connects the bars of two shorter One-Handed Bar Clamps to create one longer clamp	5706919889204	40	5
1988931	Heavy-Duty Clamp Coupler		5706919889310	40	5

HOLD DOWN JIG



1988932

ITEM NO.	DESCRIPTION	APPLICATION INFORMATION	EAN	MASTER PACK	SHELF PACK
1988932	Hold Down Jig	Converts One-Handed Bar Clamp into a table clamp	5706919889327	40	5

WIDE PADS



1988933

ITEM NO.	DESCRIPTION	APPLICATION INFORMATION	EAN	MASTER PACK	SHELF PACK
1988933	Wide Pads	Double the width of standard pads to distribute clamping force onto a wider surface area	5706919889334	40	5

CORNER CLAMP

ITEM NO.	DESCRIPTION	APPLICATION INFORMATION	EAN	MASTER PACK	SHELF PACK
1988935	Corner Clamp Pads	Converts One-Handed Bar Clamp into a corner clamp for easy clamping of 90° angles	5706919889358	40	5



DECK TOOL

ITEM NO.	DESCRIPTION	APPLICATION INFORMATION	EAN	MASTER PACK	SHELF PACK
1988934	Deck Tool Kit	Converts One-Handed Bar Clamp into a deck clamp for easy, accurate spacing, aligning and holding during deck building	5706919889341	40	5



CLAMP STAND

ITEM NO.	DESCRIPTION	APPLICATION INFORMATION	EAN	MASTER PACK	SHELF PACK
1988936	Clamp Stand	Converts One-Handed Bar Clamp for level clamping; ideal for parallel clamping applications such as frames, caseworks and drawers	5706919889365	40	5









ACCESSORY SELECTION GUIDE

SKU Code	Accessories	NEW		Quick-Change	XP
		Medium-Duty	Heavy-Duty		
1988919	Edge Clamp	✓		✓	
1988920	Medium-Duty Clamp Coupler	✓		✓	
1988931	Heavy-Duty Clamp Coupler		✓		✓
1988932	Hold Down Jig	✓	✓	✓	✓
1988933	Wide Pads	✓	✓		
1988934	Deck Tool Kit	✓			
1988935	Corner Clamp Pads	✓	✓		
1988936	Clamp Stand	✓	✓	✓	✓



QUICK-GRIP®

CLAMPING TOOLS SELECTION GUIDE

CLAMPS & SPECS	ONE-HANDED BAR CLAMPS				HANDI / SPRING CLAMPS	
	 MICRO	 MINI	 MEDIUM-DUTY	 HEAVY-DUTY	 HANDI-CLAMP	 SPRING CLAMP
Holding Force:	15 kg / 35 lbs	63 kg / 140 lbs	136 kg / 300 lbs	272 kg / 600 lbs	20 - 40 kg	15 - 30 kg
Clamp Capacity:	115 mm	150 - 300 mm	150 - 900 mm	150 - 1250 mm	30 - 100 mm	30 - 75 mm
Throat Depth:	30mm (1-3/16")	62mm (2-7/16")	81 mm (3-3/16")	92mm (3-5/8")	38 - 100 mm	30 - 75 mm
Spreading Capacity:	-	-	200mm - 1120mm (7-7/8" - 43-3/8")	235mm - 1496mm (9-1/4" - 58-7/8")	-	-
Crafts / light-duty clamping	●	●	◐		◐	○
Temporary hold-down quick clamping	●	●	●	●	◐	○
Flat panels / Solid edge wood glue-up / Deep-reach clamping				◐		
Irregular shape / Multiple surface Corner joining			◐	◐		
Installation / Demolition / Heavy-duty clamping			◐	●		

○ = Good ◐ = Better ● = Best



Record®

HEAVY-DUTY CLAMPING

IRWIN® Record® range of PRO clamps deliver the right fit, features and pressure for heavy-duty clamping jobs. Professionals will get the clamping performance they need to get the job done right.

IRWIN® RECORD® PRO CLAMP

THERMOPLASTIC ELASTOMERS (TPE) PADS

3-COMPONENT HANDLE

ZINC PLATED I-BEAM

ENHANCED PERFORMANCE

- 1. THERMOPLASTIC ELASTOMERS (TPE) PADS**
Pads snap fit to prevent loss and provide excellent friction to work surface while reducing marking
- 2. 3-COMPONENT HANDLE**
For higher torque transfer than wood, plus added comfort (L range has tommy bar)
- 3. ENHANCED PERFORMANCE**
Updated Rib location improves strength at less weight and allows the clamp to stand horizontally or vertically
- 4. ZINC PLATED I-BEAM**
Provides higher mechanical strength, less torsion and rust prevention

PRO CLAMP HOLDING PRESSURES COMPARISON

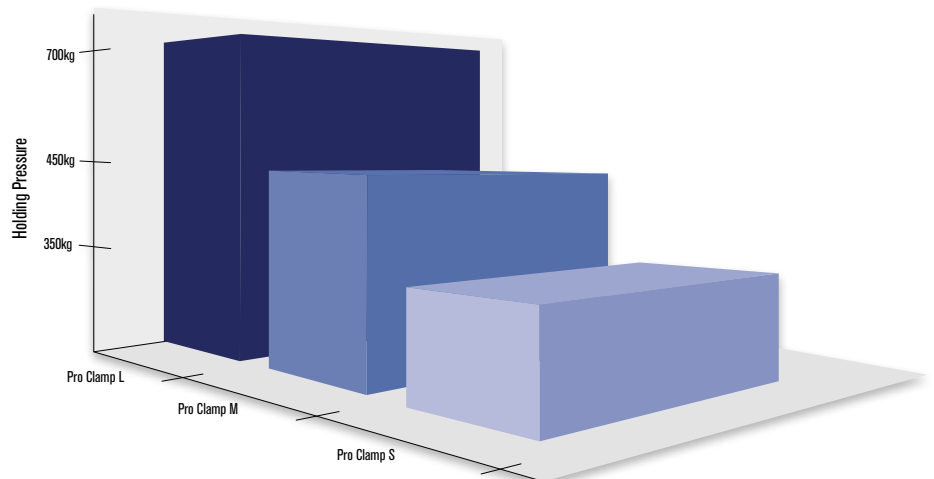

HEAVY-DUTY PRO CLAMP L WITH TOMMY BAR - CLAMPING DEPTH 140mm

Bar Dimension 35 x 9 mm

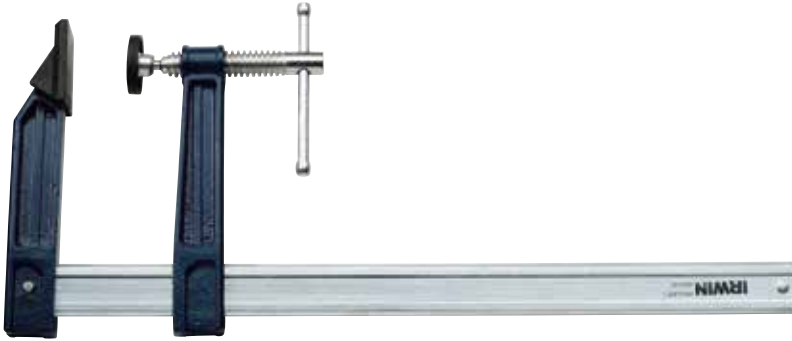

700 kg

HOLDING PRESSURE

ITEM NO.	DESCRIPTION	CLAMP CAPACITY	EAN	MASTER PACK	SHELF PACK
10503574	Pro Clamp L, 400mm	16" / 400mm	5706915035742	-	3
10503575	Pro Clamp L, 600mm	24" / 600mm	5706915035759	-	3
10503576	Pro Clamp L, 800mm	32" / 800mm	5706915035766	-	3
10503577	Pro Clamp L, 1000mm	40" / 1000mm	5706915035773	-	3
10503578	Pro Clamp L, 1250mm	50" / 1250mm	5706915035780	-	3
10503579	Pro Clamp L, 1500mm	60" / 1500mm	5706915035797	-	3



10503574

MEDIUM DUTY PRO CLAMP M - CLAMPING DEPTH 120mm

Bar Dimension 30 x 8 mm



450 kg

HOLDING PRESSURE

ITEM NO.	DESCRIPTION	CLAMP CAPACITY	EAN	MASTER PACK	SHELF PACK
10503569	Pro Clamp M, 300mm	12" / 300mm	5706915035698	-	4
10503570	Pro Clamp M, 400mm	16" / 400mm	5706915035704	-	4
10503571	Pro Clamp M, 600mm	24" / 600mm	5706915035711	-	4
10503572	Pro Clamp M, 800mm	32" / 800mm	5706915035728	-	4
10503573	Pro Clamp M, 1000mm	40" / 1000mm	5706915035735	-	4



10503569

LIGHT DUTY PRO CLAMP S - CLAMPING DEPTH 80mm

Bar Dimension 25 x 6 mm



350 kg

HOLDING PRESSURE

ITEM NO.	DESCRIPTION	CLAMP CAPACITY	EAN	MASTER PACK	SHELF PACK
10503564	Pro Clamp S, 200mm	8" / 200mm	5706915035643	-	4
10503565	Pro Clamp S, 300mm	12" / 300mm	5706915035650	-	4
10503566	Pro Clamp S, 400mm	16" / 400mm	5706915035667	-	4
10503567	Pro Clamp S, 600mm	24" / 600mm	5706915035674	-	4
10503568	Pro Clamp S, 800mm	32" / 800mm	5706915035681	-	4



10503565



Record®

T-BAR CLAMPS 136 SERIES AND SPARE PARTS

These clamps resist twisting and distortion under clamping pressures. Both the head and slide are guaranteed unbreakable. The slide is secured by a solid steel pin passing through one of the locating holes spaced along the steel bar. The steel mainscrew applies pressure quickly and smoothly through a fast acting, hard wearing rolled thread. Slides and heads are flat bottomed so that the clamp will stand without support.



1000 kg
HOLDING PRESSURE

ITEM NO.	DESCRIPTION	CLAMP CAPACITY	EAN	MASTER PACK	SHELF PACK
T1365	T-Bar Clamp	42" / 1070mm	0734442034087	-	1
T1366	T-Bar Clamp	48" / 1200mm	0734442034209	-	1
T1367	T-Bar Clamp	54" / 1350mm	0734442034322	-	1
T1369	T-Bar Clamp	66" / 1680mm	0734442034445	-	1
T13611	T-Bar Clamp	78" / 1980mm	0734442034568	-	1
TL1366	48" Lengthening Bar (1220mm)	-	0734442034681	-	1
T136D	Tailslide with Peg & Chain	-	0734442046561	-	1

SASH CLAMPS 135 SERIES AND SPARE PARTS

These cut heavy-duty clamps have a bar section of 32mm x 6mm (1-1/4" x 1/4"). The slide and head are guaranteed unbreakable.



500 kg
HOLDING PRESSURE

ITEM NO.	DESCRIPTION	CLAMP CAPACITY	EAN	MASTER PACK	SHELF PACK
T1352	Sash Clamp	24" / 610mm	0734442033363	-	1
T1353	Sash Clamp	30" / 760mm	0734442033486	-	1
T1354	Sash Clamp	36" / 915mm	0734442033608	-	1
T1355	Sash Clamp	42" / 1070mm	0734442033721	-	1
T1356	Sash Clamp	48" / 1220mm	0734442033844	-	1
T1357	Sash Clamp	54" / 1370mm	0734442033851	-	1
T1359	Sash Clamp	66" / 1980mm	0734442033875	-	1
TL1354	Sash Clamp, 36" Lengthening Bar (915mm)	-	0734442033967	-	1
T135D	Tailslide with Peg & Chain	-	0734442045366	-	1
T135E	Peg & Chain	-	0734442045960	-	1

CLAMP HEADS

Low cost alternative to full size bar clamps, the grey cast iron head and slide with steel mainscrew can be fitted to a wooden batten 25mm (1") thick by 38mm (1-1/2") wide and any length.

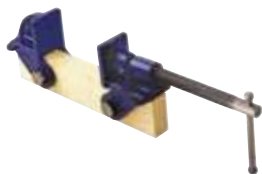

ITEM NO.	DESCRIPTION	EAN	MASTER PACK	SHELF PACK
TM130	Clamp Head, 1" x 1-1/2" / 25 x 38mm	0734442348078	-	6

MITRE CUTTING CORNER CLAMPS

Accurate mitre clamping is provided by IRWIN® Record® Corner Clamps. The clamps have two countersunk holes for fixing to a wooden block, which can then be secured between the jaws of a bench vice. Thanks to the precision machined clamping surfaces and open design, these clamps are straight forward to operate and provide easy access for glueing and nailing.



ITEM NO.	DESCRIPTION	CLAMP CAPACITY	EAN	MASTER PACK	SHELF PACK
TM140	Mitre Cutting Corner Clamp 50mm	2" / 50mm	0734442028444	24	1
TM141	Mitre Cutting Corner Clamp 100mm	4-1/4" / 105mm	0734442028404	24	1

FLOORING CLAMP

Designed to close up floor boards prior to nailing, this compact and robust clamp has two spring loaded cams which straddle the joist, holding the clamp firmly in position. Turning the handle then moves the shoe forward, pushing the floorboard into position. For standard 75mm (3") joists.



ITEM NO.	DESCRIPTION	CLAMP CAPACITY	EAN	MASTER PACK	SHELF PACK
TMFC153	Unbreakable S.G. Iron Flooring Clamp 75mm	3" / 75mm	0734442034926	6	1

G-CLAMPS

IRWIN® Record® G-Clamps have an I-Braced design. They feature an adjustable steel swivel shoe to help clamp uneven surfaces and operation is fast and smooth due to the twin-start Acme cold rolled thread.

HEAVY-DUTY G-CLAMPS 121 SERIES - THE STRONGEST G-CLAMP

HEAVY-DUTY G-CLAMPS 121 SERIES

IRWIN® Record® Heavy-Duty G-Clamps are recommended particularly for metalworking and fabrication work where a very high clamping force is demanded.

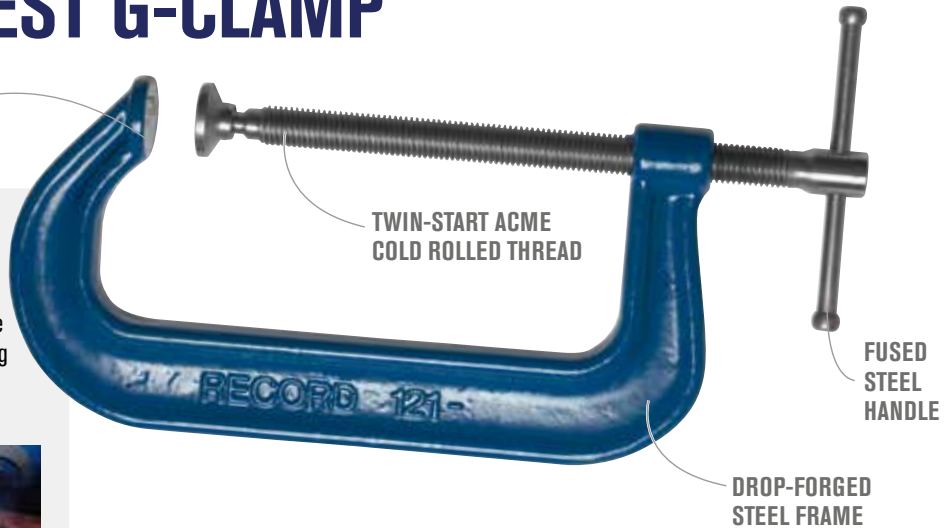

- 1. DROP-FORGED STEEL FRAME**
For strength and durability. Recommended for heavy-duty metal and fabrication work
- 2. SWIVEL SHOE**
Helps clamping on uneven surfaces
- 3. TWIN-START ACME COLD ROLLED THREAD**
For faster and smoother operation
- 4. FUSED STEEL HANDLE**
Will bend before the clamp can be overstressed

ITEM NO.	DESCRIPTION	CLAMP CAPACITY	PROOF LOAD	EAN	MASTER PACK	SHELF PACK
T1213	Heavy-Duty G-Clamp	3" / 75mm	2700 kg	0734442031802	24	4
T1214	Heavy-Duty G-Clamp	4" / 100mm	3200 kg	0734442031925	24	4
T1216	Heavy-Duty G-Clamp	6" / 150mm	4000 kg	0734442032045	12	1
T1218	Heavy-Duty G-Clamp	8" / 200mm	5770 kg	0734442032168	12	1
T12110	Heavy-Duty G-Clamp	10" / 250mm	6200 kg	0734442032281	6	1
T12112	Heavy-Duty G-Clamp	12" / 300mm	6800 kg	0734442032403	6	1
T1224	Deep Throat G-Clamp	4" / 100mm	-	0734442030843	40	4



MEDIUM-DUTY G-CLAMPS 119 SERIES

IRWIN® Record® medium-duty clamps have a thin frame for getting into tight corners and confined spaces, yet are very strong and rigid.

ITEM NO.	DESCRIPTION	CLAMP CAPACITY	EAN	MASTER PACK	SHELF PACK
T1192	Medium-Duty G-Clamp	2" / 50mm	0734442030485	-	6
T1193	Medium-Duty G-Clamp	3" / 75mm	0734442030720	-	6
T1194	Medium-Duty G-Clamp	4" / 100mm	0734442000600	-	6
T1196	Medium-Duty G-Clamp	6" / 150mm	0734442041337	-	6



GENERAL PURPOSE G-CLAMPS 120 SERIES

Ideal for metal and woodworking applications, the IRWIN® Record® 120 is the most popular and widely used of G-Clamps.

ITEM NO.	DESCRIPTION	CLAMP CAPACITY	EAN	MASTER PACK	SHELF PACK
T1203	General Purpose G-Clamp	3" / 75mm	0734442031086	72	4
T1204	General Purpose G-Clamp	4" / 100mm	0734442031208	72	4
T1206	General Purpose G-Clamp	6" / 150mm	0734442031321	60	4
T1208	General Purpose G-Clamp	8" / 200mm	0734442031444	24	1
T12010	General Purpose G-Clamp	10" / 250mm	0734442031567	24	1
T12012	General Purpose G-Clamp	12" / 300mm	0734442031680	24	1





Record®

VICES AND ACCESSORIES

IRWIN® Record® Vices have become the benchmark by which all other vices are measured. Design, choice of materials and manufacturing disciplines each set very high standards which, for the end user, translate into safety, reliability and excellent value.

ENGINEERS' VICE - LIFETIME VICE RANGE

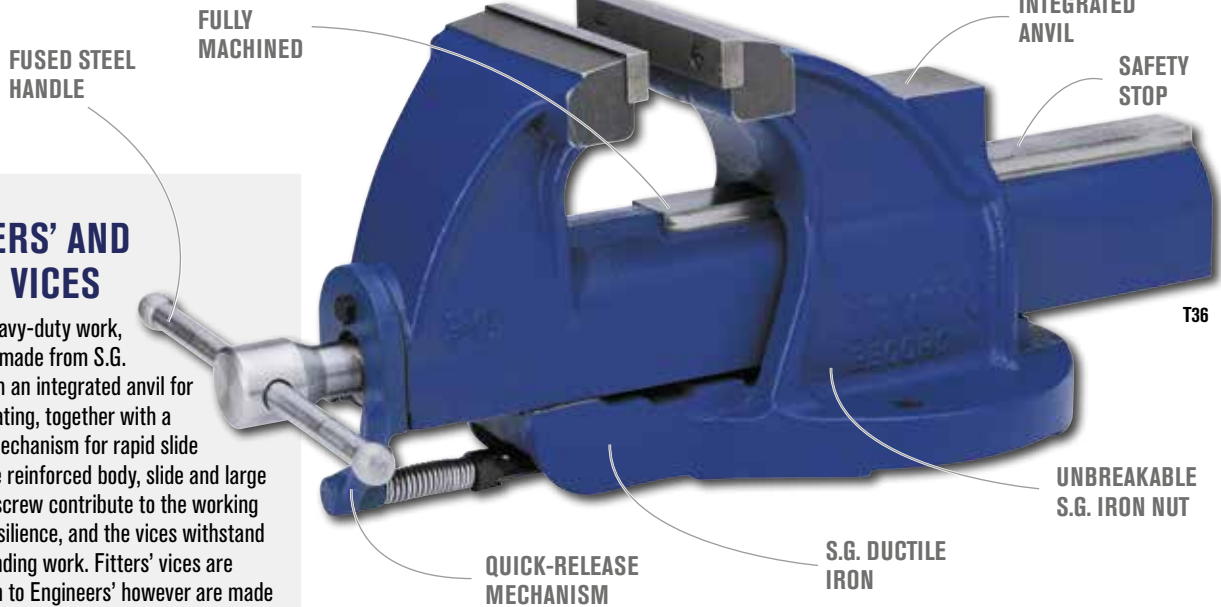

ENGINEERS' AND FITTERS' VICES

Designed for heavy-duty work, these vices are made from S.G. Ductile Iron with an integrated anvil for shaping and beating, together with a quick-release mechanism for rapid slide adjustment. The reinforced body, slide and large diameter main screw contribute to the working strength and resilience, and the vices withstand the most demanding work. Fitters' vices are similar in design to Engineers' vices however are made of close grained gray iron instead of S.G. Ductile Iron. They also have a full line of replacement parts available.



- 1. S.G. DUCTILE IRON**
Material with high-impact resistance guarantees strength and long life (Engineers' vices only)
- 2. SAFETY STOP**
Prevents the slide from being separated from the body
- 3. FULLY MACHINED**
On all load-bearing surfaces for smooth and trouble-free operation
- 4. FUSED STEEL HANDLE**
Will bend before the vice can be overstressed
- 5. QUICK-RELEASE MECHANISM**
Disengages the main screw, allowing rapid movement of the slide
- 6. UNBREAKABLE S.G. IRON NUT**
Can be replaced when worn
- 7. INTEGRATED ANVIL**
For efficient striking of workpieces when required

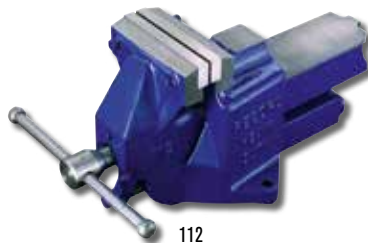
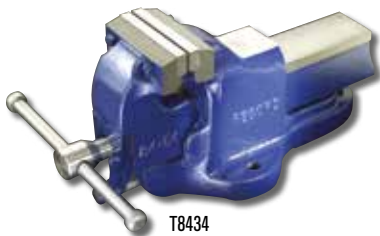

ITEM NO.	DESCRIPTION	EAN	MASTER PACK	SHELF PACK
T8434	Engineers Vice 4-1/2" / 115mm**	0734442019442	42	1
T36	Engineers Vice 6" / 150mm** (Irregular Shape)	0734442019206	18	1
112	Engineers Vice 6" / 150mm**	0734442019565	22	1
114ZR	Engineers Vice 8" / 205mm**	0734442019688	22	1
23ZR	Fitters Vice 4-1/2" / 115mm	0734442001089	28	1
T25	Fitters Vice 6" / 150mm	0734442001201	22	1

For spare parts please visit www.2helpu.com. Please see page 101 for more details

** S.G. Ductile Iron is strong and flexible with similar characteristics to steel and is virtually unbreakable. Heavy duty vices manufactured from this material are designed to take much more punishing workloads than normal vices.



Record®

QUICK-ADJUSTING VICE GENERAL PURPOSE / MEDIUM-DUTY

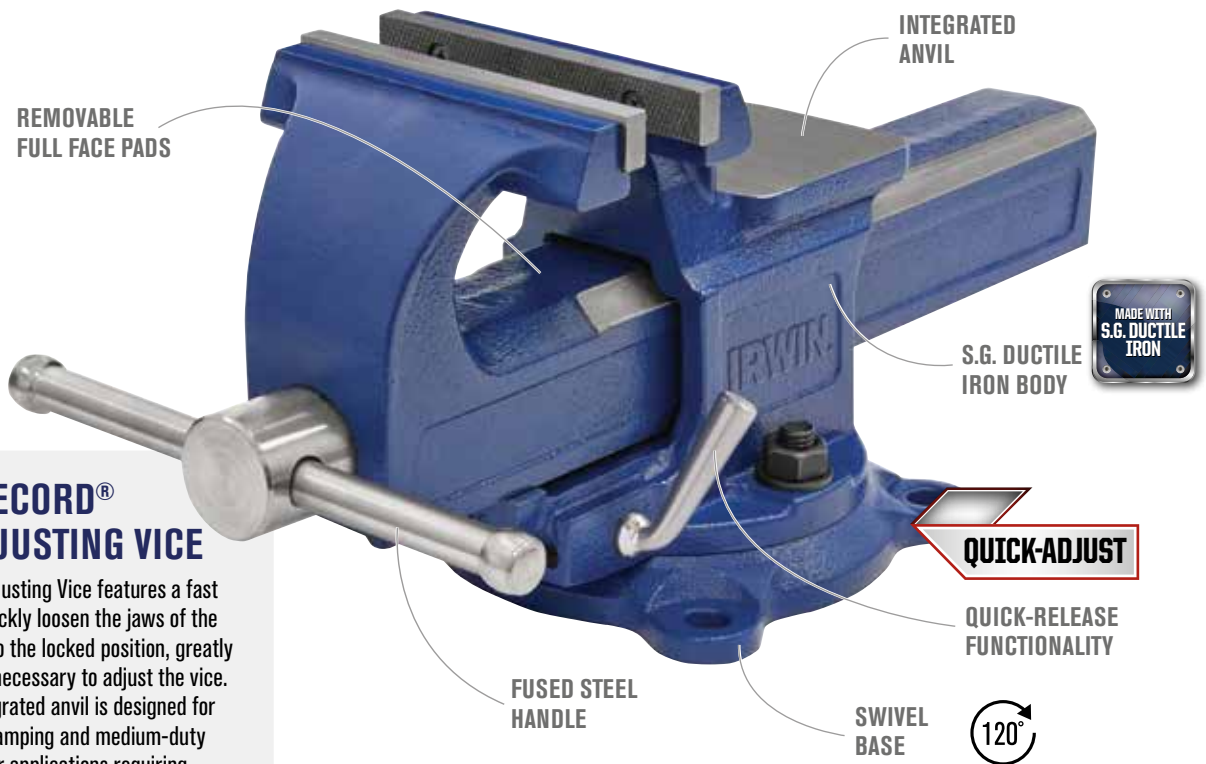

IRWIN® RECORD® QUICK-ADJUSTING VICE

The NEW Quick-Adjusting Vice features a fast release lever to quickly loosen the jaws of the vice and return it to the locked position, greatly reducing the time necessary to adjust the vice. This vice with integrated anvil is designed for general purpose clamping and medium-duty applications and for applications requiring frequent clamping and changing of multiple materials.



1. QUICK-RELEASE FUNCTIONALITY

Fast-release lever for quick adjustments to increase productivity

2. S.G. DUCTILE IRON BODY

Guaranteeing strength and long life

3. SWIVEL BASE

Three mounting points and a 120° rotation for more flexible positioning of workpieces

4. FUSED STEEL HANDLE

Will bend before the vice can be overstressed

5. INTEGRATED ANVIL

For hammering and beating workpieces

6. SAFETY STOP

Prevents slide separating from body



1978272

ITEM NO.	DESCRIPTION	EAN	MASTER PACK	SHELF PACK
1978271	Quick-Adjusting Vice 4" / 100mm	5706919782710	1	1
1978272	Quick-Adjusting Vice 5" / 125mm	5706919782727	1	1

MECHANICS' VICE - HEAVY-DUTY RANGE

HARDENED
STEEL JAWS

FUSED STEEL
HANDLE

SAFETY
STOP

IRWIN® RECORD® MECHANICS' VICE

Rigid and robust, the body and sliding jaw are cast from close grained grey iron which is machined on all friction surfaces for a smooth, reliable action.

The jaws, handle and main screw are steel, the latter having a two-start rolled acme thread to speed the jaws from fully closed to fully open with a minimum of winding. The Mechanics' vice is the most commonly used vice in the IRWIN® Record® range. A full line of replacement parts are available.

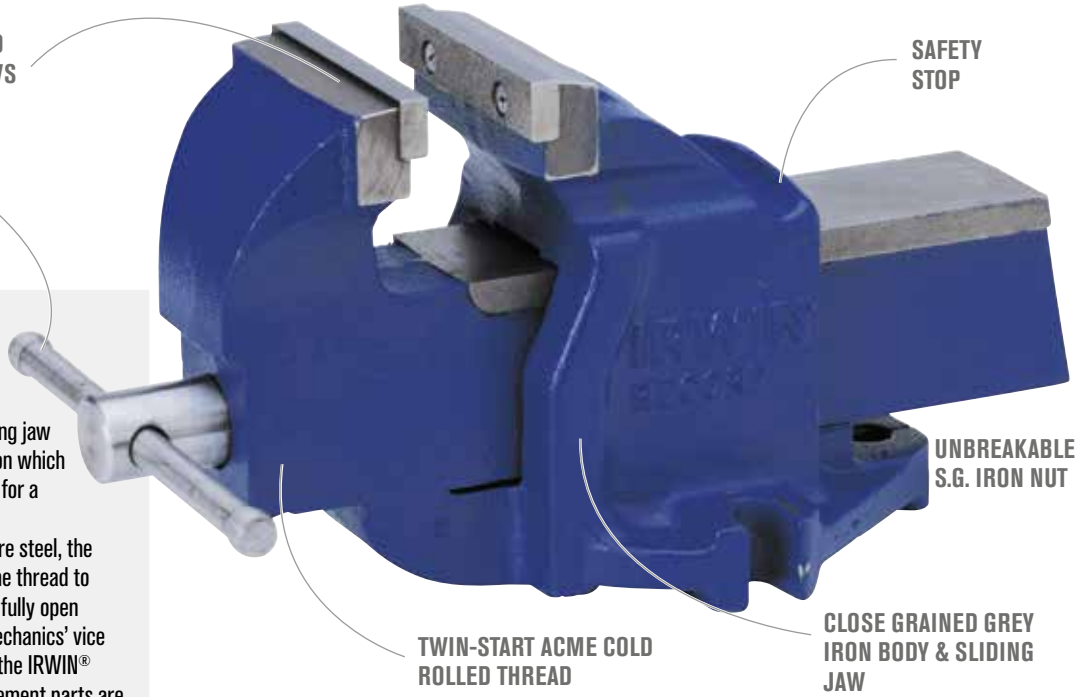

UNBREAKABLE
S.G. IRON NUT

TWIN-START ACME COLD
ROLLED THREAD

CLOSE GRAINED GREY
IRON BODY & SLIDING
JAW

- 1. CLOSE GRAINED GREY IRON BODY & SLIDING JAW**
Cast then machined on all friction surfaces for a smooth, reliable action
- 2. SAFETY STOP**
Prevents the slide from being separated from the body
- 3. HARDENED STEEL JAWS**
Extend the life of the jaws and are replaceable
- 4. UNBREAKABLE S.G. IRON NUT**
Can be replaced when worn
- 5. FUSED STEEL HANDLE**
Will bend before the vice can be overstressed
- 6. TWIN-START ACME COLD ROLLED THREAD**
For faster and smoother operation

ITEM NO.	DESCRIPTION	EAN	MASTER PACK	SHELF PACK
1ZR	No 1, Mechanics' Vice 3" / 75mm	0734442000129	144	1
3	No 3, Mechanics' Vice 4" / 100mm	0734442000488	60	1
4ZR	No 4, Mechanics' Vice 4-1/2" / 115mm	0734442000501	40	1
5	No 5, Mechanics' Vice 5" / 125mm	0734442000723	40	1
6	No 6, Mechanics' Vice 6" / 150mm	0734442000846	32	1
8ZR	No 8, Mechanics' Vice 8" / 205mm	0734442000969	24	1



WORKSHOP VICE - MEDIUM DUTY

Strong and durable, the body and sliding jaw are cast from close-grained grey iron which is machined on all friction surfaces for a smooth reliable action. The jaws, handle and main screw are steel, the latter having a two-start rolled acme thread to speed the jaws from fully closed to fully open with a minimum of winding. This compact bench vice with anvil is specifically designed for medium-duty workshop applications for both the professional craftsman and the DIY enthusiast who expect a compact vice with superior clamping force, safety features and excellent finish.

ITEM NO.	DESCRIPTION	EAN	MASTER PACK	SHELF PACK
10507771	Workshop Vice with Anvil, 3-1/8" / 80mm	5706915077711	1	1
T41211000	Workshop Vice with Anvil, 1 TON, 4" / 100mm	0734442000204	105	1
T3TON3VS	Workshop Vice with Anvil, Swivel Base, 4" / 100mm	0734442000310	60	1
4935505	Workshop Multi-Vice, with Anvil, Swivel Base, 5" / 125mm	0038548989990	40	1
T6TON6VS	Workshop Vice with Anvil, Swivel Base, 6" / 150mm	0734442000860	40	1
8ZR	No 8, Mechanics' Vice 8" / 205mm	0734442000969	24	1



Record®

PROFESSIONAL QUICK-RELEASE WOODWORKING VICE

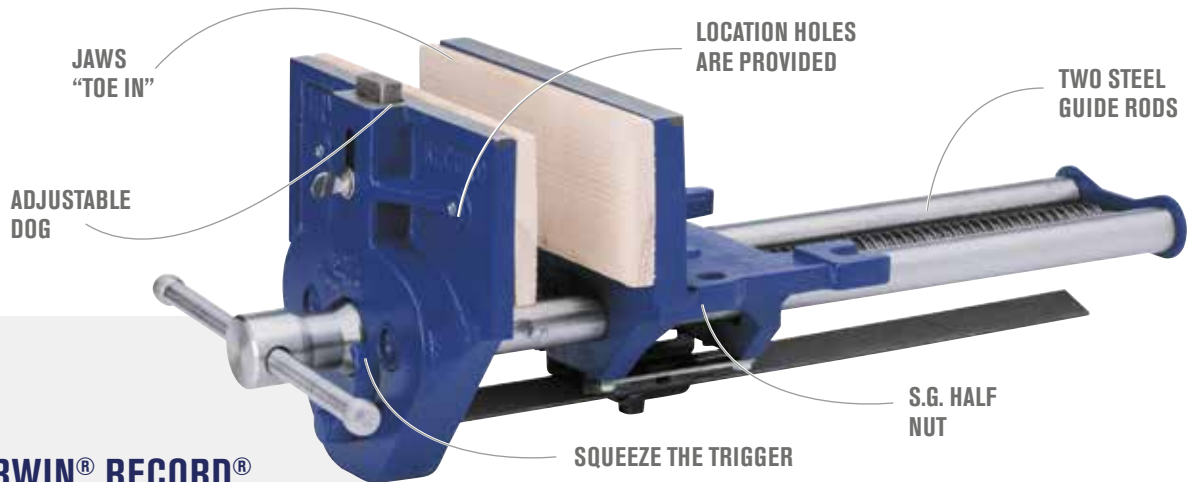

IRWIN® RECORD® QUICK-RELEASE VICE

Squeeze the trigger and a quick-release vice can be opened and closed without using the mainscrew. Large and small work pieces can be quickly interchanged, while releasing the trigger returns the mechanism to normal for fine adjustment. An ideal addition to the engineering workshop or tool room. For clamping and holding wood work pieces.

- TWO STEEL GUIDE RODS**
To reduce wear and ensure a smooth parallel action
- JAWS "TOE IN"**
When pressure is applied they give an even clamping over the whole depth of the work-piece
- ADJUSTABLE DOG**
Used in conjunction with bench stops fitted into the bench top
- LOCATION HOLES ARE PROVIDED**
So you can fit your own choice of wooden checks to protect the work-piece
- SQUEEZE THE TRIGGER**
A quick release vice can be opened and closed without using the mainscrew. Large and small work-pieces can be quickly interchanged
- S.G. HALF NUT**
For longevity and durability replaceable when worn



T5212ED

ITEM NO.	DESCRIPTION	EAN	MASTER PACK	SHELF PACK
T52ED	Woodworking Vice - Quick-Release 7"/175mm	0734442030249	60	1
T5212ED	Woodworking Vice - Quick-Release 9"/230mm	0734442030362	32	1
T53ED	Woodworking Vice - Quick-Release 10-1/2"/265mm	0734442030010	24	1

PLAIN SCREW VICE

Manufactured in three capacities, these full size workshop vices are designed for bench mounting. The cast grey iron body and front plate are precision machined to house two solid steel guide rods giving the vice a smooth, true parallel action free of side or cross movement.



T53PD

ITEM NO.	DESCRIPTION	EAN	MASTER PACK	SHELF PACK
T52PD	Woodworking Vice - Plain Screw 7"/175mm	0734442047889	60	1
T5212PD	Woodworking Vice - Plain Screw 9"/230mm	0734442029796	32	1
T53PD	Woodworking Vice - Plain Screw 10-1/2"/265mm	0734442030133	24	1

WOODCRAFT VICE

Lightweight vice for the young woodworker, or home handyman. Provides a robust product suitable for the professional who needs a compact vice for smaller work. Designed to be fitted under the work bench, in the normal way, so that the jaws are flush with the bench top. TV150B includes table clamp.



TV150B

ITEM NO.	DESCRIPTION	EAN	MASTER PACK	SHELF PACK
TV149B	Woodcraft Vice 6"/150mm	0734442029656	-	1
TV150B	Woodcraft Vice with Table Clamp 6"/150mm	0734442029779	-	1
TV175B	Woodcraft Vice 7"/175mm	0734442029885	-	1

TABLE VICE

This is an ideal portable vice for the amateur and model maker. The built-in clamp allows it to be easily and quickly attached to a bench, table or work surface. Pipe grips are incorporated below the parallel jaws. A useful anvil is also included on the rear of the body.

ITEM NO.	DESCRIPTION	EAN	MASTER PACK	SHELF PACK
TV75B	Table Vice 3" / 75mm	0734442001690	-	1



TV75B

DRILL PRESS VICE

Quality and precision are the hallmarks of the IRWIN® Record® Drill Press Vice, an ideal addition to the engineering workshop or tool room. Designed for use with drill presses and pillar drills.

ITEM NO.	DESCRIPTION	EAN	MASTER PACK	SHELF PACK
T414	Drill Press Vice 4" / 100mm	0734442001560	-	1



T414

SWIVEL BASES

360 degree swivel bases are used to rotate and lock the vice at the most convenient angle.

ITEM NO.	DESCRIPTION	EAN	MASTER PACK	SHELF PACK
T1SB	Swivel Base, (No. 1 Vice)	0734442002888	-	1
T3SB	Swivel Base, (No. 3 Vice)	0734442003007	-	1
T4SB	Swivel Base, (No. 4 & 5 Vice)	0734442003120	-	1
T6SB	Swivel Base, (No. 6, 8, 25 & 36 Vices)	0734442003366	-	1
T843423SB	Swivel Base, (No. T8434 & 23ZR Vices)	0734442019459	-	1
10507772	Swivel Base, (No. 10507771)	5706915077728	-	1



T1SB

FIBRE GRIPS

Designed for holding & protecting workpieces of copper, aluminium, brass and similar soft metals.

ITEM NO.	DESCRIPTION	EAN	MASTER PACK	SHELF PACK
FG3	Fibre Grips 3" / 75mm	0734442001928	60	6
FG4	Fibre Grips 4" / 100mm	0734442002161	60	6
FG412	Fibre Grips 4-1/2" / 115mm	0734442002406	60	6
FG5	Fibre Grips 5" / 125mm	0734442002529	60	6
FG6	Fibre Grips 6" / 150mm	0734442002765	60	6

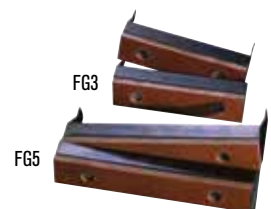

FG3

FG5

CHAIN PIPE VICES

The chain pipe vice generates a powerful grip due to its sturdy construction. The drop-forged, heat-treated steel jaws and high-tensile steel chain are mounted on a body cast from ductile iron that is guaranteed unbreakable. The flexible chain means the vice is compact and easy to store when not in use.

ITEM NO.	DESCRIPTION	EAN	MASTER PACK	SHELF PACK
T181C	Chain Pipe Vice 1/8" - 2" / 3 - 50mm	0734442143161	-	1
T182C	Chain Pipe Vice 1/4" - 4" / 6 - 100mm	0734442143284	-	1
T183C	Chain Pipe Vice 1/2" - 8" / 12 - 200mm	0734442143406	-	1



T182C

HINGED PIPE VICES

The hinged pipe vice frame and base are cast from high-impact resistant S.G. ductile iron guaranteeing strength. The design is ideal for fast, repetitive work.

ITEM NO.	DESCRIPTION	EAN	MASTER PACK	SHELF PACK
T92C	Hinged Pipe Vice 1/8" - 2" / 3 - 50mm	0734442143529	-	1
T9212C	Hinged Pipe Vice 1/8" - 2-1/2" / 3 - 60mm	0734442143642	-	1
T9312C	Hinged Pipe Vice 1/8" - 3-1/2" / 3 - 90mm	0734442143765	-	1
T96	Hinged Pipe Vice 1/8" - 6" / 3 - 150mm	0734442143888	-	1



T9312C

TRIPOD STAND

The durable fabricated steel frame, topped by a strong heavy-gauge mounting plate, is drilled to accept our range of chain and hinged pipe vices.

ITEM NO.	DESCRIPTION	EAN	MASTER PACK	SHELF PACK
TS10	Tripod Stand for Hinged Pipe Vice & Chain Pipe Vice (T182C, T92C, T9212C)	0734442142560	-	1

Please order spare parts via www.2helpu.com. Please see page 101.





SCREWDRIVERS, MULTI-BIT TOOLS & HEX KEYS

INNOVATIVE MULTI-TOOLS DESIGNED TO DELIVER EASE & DURABILITY TO TACKLE ANY JOB

The innovative lineup of IRWIN® Multi-Bit Drive Tools has been designed to address a variety of challenges professionals face on the job. The Extending Multi-Bit Screwdriver adjusts from 125mm to 280mm to get into hard-to-reach spaces, while the 6-in-1 Nut Driver increases efficiency with convenient on-board storage. The Guide Sleeve and Magnetic Multi-Bit Screwdrivers are both compatible with any fastener drive bit and help hold fasteners securely in place for easy driving. Plus, all drivers feature unique handle designs to improve comfort and torque.



3-zone Comfort Grip increases comfort in high and low applications

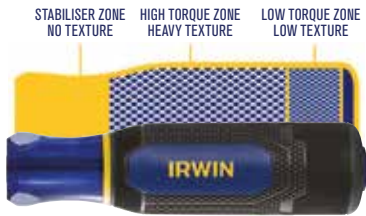

TorqueZone™ design for optimal comfort and torque

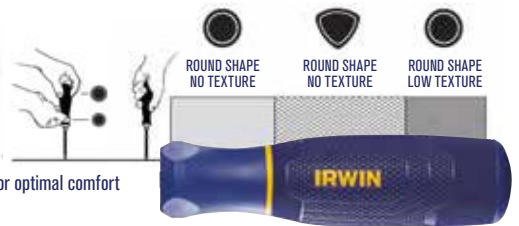

Available on: IRWIN® 6-in-1 Nut Driver, IRWIN® 5-in-1 Extending Multi-Bit Screwdriver and IRWIN® 5-in-1 Guide Sleeve Multi-Bit Screwdriver

Available on: IRWIN® 5-in-1 Magnetic Multi-Bit Screwdriver

MULTI TOOLS



PRO COMFORT



HEX KEYS



6-IN-1 NUT DRIVER

FEATURES
6 NUT DRIVER
SIZES

CONVENIENT FASTENING FOR NUTS & BOLTS

This one-of-a-kind tool increases convenience on the job by combining 6 metric sizes to fasten nuts and bolts with one tool. It features on-board storage of three double-ended sockets for easy access to six different hex sizes.



CRAFTED WITH AN
ACETATE HANDLE



3-ZONE
COMFORT
GRIP



COMPACT, IN-HANDLE
SOCKET STORAGE

- 1. FEATURES 6 NUT DRIVER SIZES**
In one tool for superior efficiency
- 2. COMPACT, IN-HANDLE SOCKET STORAGE**
Provides easy access to 3 double-ended sockets
- 3. 3-ZONE COMFORT GRIP**
Maximises performance and increases comfort in high and low torque applications
- 4. CRAFTED WITH AN ACETATE HANDLE**
Built for maximum durability
- 5. SOCKET SIZES INCLUDED:**
6mm, 7mm, 8mm, 10mm, 11mm, and 13mm



ITEM NO.	DESCRIPTION	EAN	SHELF PACK
2013288	12 Piece CDU with 6-in-1 Metric Nut Drivers	5706915166156	12

5-IN-1 EXTENDING MULTI-BIT SCREWDRIVER

INTEGRATED BIT HOLDER

DRIVER EXTENDS

QUICK-LOCKING MECHANISM

CRAFTED WITH AN ACETATE HANDLE



3-ZONE COMFORT GRIP

7 LENGTHS IN ONE DRIVER

Making it easier than ever before to work in hard-to-reach spaces, this screwdriver extends from 125mm to 280mm (5" to 11"), locking securely at each 25mm (1") increment. Plus, for even more versatility, this screwdriver can use standard insert or power bits, making replacement easy.

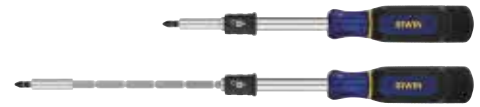

- 1. DRIVER EXTENDS**
From 125mm to 280mm (5" to 11") for maximum versatility
- 2. QUICK-LOCKING MECHANISM**
Securely locks at each 25mm (1") increment to provide 7 lengths in total
- 3. 3-ZONE COMFORT GRIP**
Maximises performance and increases comfort in high and low torque applications
- 4. CRAFTED WITH AN ACETATE HANDLE**
Built for maximum durability

- 5. INTEGRATED BIT HOLDER**
Accepts insert and power bits
- 6. INCLUDED FASTENER DRIVE BITS**
Feature precision tip geometry for superior fitment, reducing stripping and cam-out
- 7. FASTENER DRIVE BITS INCLUDED:**
PH2, PZ1, PZ2, SL 5-6 and T20

ITEM NO.	DESCRIPTION	EAN	SHELF PACK
2013286	12 Piece CDU with Extending Multi Bit Screwdrivers	5706915132865	12



5-IN-1 GUIDE SLEEVE MULTI-BIT SCREWDRIVER

MAGNETISED BIT HOLDER

3-ZONE COMFORT GRIP

METAL SLEEVE

CRAFTED WITH AN ACETATE HANDLE

IRWIN

3-ZONE COMFORT GRIP

GUIDE SLEEVE KEEPS SCREWS STRAIGHT.

KEEPS SCREWS STRAIGHT

This convenient tool features a magnetised bit holder and metal sleeve that slides forward to keep fasteners straight and eliminate screw wobble. This driver is compatible with insert and power bits for easy replacement.

- METAL SLEEVE**
Slides forward to keep fastener straight and eliminate screw wobble
- MAGNETISED BIT HOLDER**
Compatible with insert bits and power bits for convenient replacement
- 3-ZONE COMFORT GRIP**
Maximises performance and increases comfort in high and low torque applications
- CRAFTED WITH AN ACETATE HANDLE**
Built for maximum durability
- INCLUDED FASTENER DRIVE BITS**
Feature precision tip geometry for superior fitment, reducing stripping and cam-out
- FASTENER DRIVE BITS INCLUDED:**
PH2, PZ1, PZ2, SL6-8 and T20



ITEM NO.	DESCRIPTION	EAN	SHELF PACK
2013285	12 Piece CDU with Guide Sleeve Multi Bit Screwdrivers	5706915132856	12

5-IN-1 MAGNETIC MULTI-BIT SCREWDRIVER

MAGNETISED BIT HOLDER

HOLDS BITS SECURELY

This multi-tool features a magnetised bit holder that holds insert and power bits securely. This magnetised holder also aids in easier screw alignment and driving.

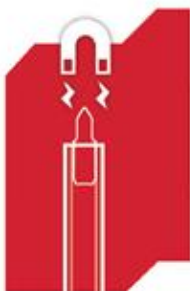

1. **MAGNETISED BIT HOLDER**
Holds insert and power bits securely
2. **MAGNETISED HOLDER**
Also aids in easier screw alignment and driving
3. **COMPATIBLE WITH INSERT BITS AND POWER BITS**
For convenient replacement



TORQUE-ZONE™ HANDLE DESIGN

COMPATIBLE WITH INSERT BITS AND POWER BITS

4. **TORQUE-ZONE™ HANDLE DESIGN**
For optimal comfort and torque
5. **INCLUDED FASTENER DRIVE BITS**
Feature precision tip geometry for superior fitment, reducing stripping and cam-out
6. **FASTENER DRIVE BITS INCLUDED:**
PH2, PZ1, PZ2, SL5-6 and T20

ITEM NO.	DESCRIPTION	EAN	SHELF PACK
2013287	12 Piece CDU with Multi-Bit Magnetic Screwdrivers	5706915132874	12





SCREWDRIVERS, MULTI-BIT TOOLS & HEX KEYS

PRO COMFORT & VDE INSULATED SCREWDRIVERS

The new IRWIN® Pro Comfort Screwdrivers have been designed for comfort, durability and safety. The screwdrivers feature a dual material, trilobular handle for an ergonomic grip, black phosphate magnetic tip and are made with Chrome-vanadium (Cr-V) steel shafts with corrosion protection. The VDE range of screwdrivers are insulated for electrical work up to 1000V AC.

PRO COMFORT SCREWDRIVERS

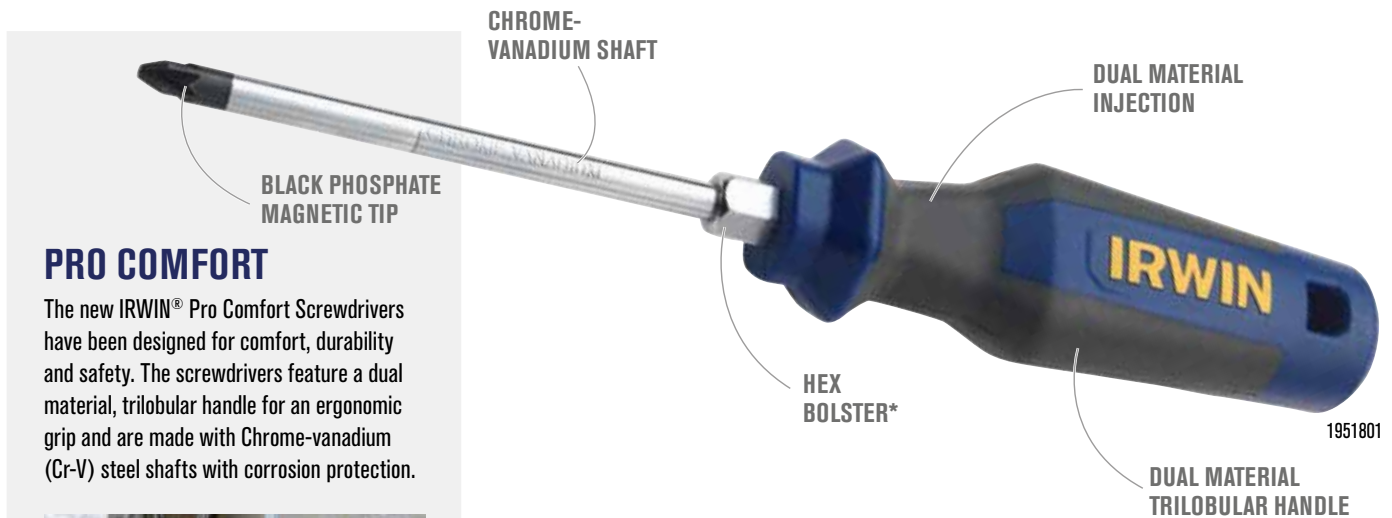

PRO COMFORT

The new IRWIN® Pro Comfort Screwdrivers have been designed for comfort, durability and safety. The screwdrivers feature a dual material, trilobular handle for an ergonomic grip and are made with Chrome-vanadium (Cr-V) steel shafts with corrosion protection.



- 1. DUAL MATERIAL TRILOBULAR HANDLE**
Provides an ergonomic grip
- 2. BLACK PHOSPHATE MAGNETIC TIP**
For improved screw alignment, easy driving and extended life of tip
- 3. DUAL MATERIAL INJECTION**
Delivers greater comfort in use
- 4. CHROME-VANADIUM SHAFT**
Includes corrosion protection for longer life of the tool
- 5. HEX BOLSTER***
Allows for increased torque with use of wrench

* Select skus only

POZIDRIV

ITEM NO.	DESCRIPTION	EAN	MASTER PACK	SHELF PACK
1951676	Pro Comfort Screwdriver PZ #0 x 80mm	5706919516766	120	6
1951677	Pro Comfort Screwdriver PZ #1 x 30mm	5706919516773	120	6
1951678	Pro Comfort Screwdriver PZ #1 x 100mm	5706919516780	72	6
1951679	Pro Comfort Screwdriver PZ #1 x 250mm	5706919516797	72	6
1951680	Pro Comfort Screwdriver PZ #2 x 30mm	5706919516803	120	6
1951801	Pro Comfort Screwdriver PZ #2 x 100mm with Hex Bolster	5706919518012	72	6
1951802	Pro Comfort Screwdriver PZ #2 x 125mm with Hex Bolster	5706919518029	72	6
1951803	Pro Comfort Screwdriver PZ #2 x 250mm with Hex Bolster	5706919518036	48	6



PHILLIPS

ITEM NO.	DESCRIPTION	EAN	MASTER PACK	SHELF PACK
1951814	Pro Comfort Screwdriver PH #0 x 80mm	5706919518142	120	6
1951807	Pro Comfort Screwdriver PH #1 x 100mm	5706919518074	72	6
1951808	Pro Comfort Screwdriver PH #1 x 250mm	5706919518081	72	6
1951810	Pro Comfort Screwdriver PH #2 x 38mm	5706919518104	120	6
1951811	Pro Comfort Screwdriver PH #2 x 100mm with Hex Bolster	5706919518111	72	6
1951812	Pro Comfort Screwdriver PH #2 x 125mm with Hex Bolster	5706919518128	72	6
1951813	Pro Comfort Screwdriver PH #2 x 250mm with Hex Bolster	5706919518135	48	6
1951816	Pro Comfort Screwdriver PH #3 x 150mm with Hex Bolster	5706919518166	48	6

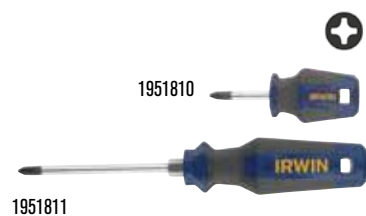

SLOTTED



1951821

ITEM NO.	DESCRIPTION	EAN	MASTER PACK	SHELF PACK
1951818	Pro Comfort Screwdriver SL 3 mm x 80mm	5706919518180	120	6
1951819	Pro Comfort Screwdriver SL 3mm x 100mm	5706919518197	120	6
1951820	Pro Comfort Screwdriver SL 5mm x 100mm	5706919518203	72	6
1951821	Pro Comfort Screwdriver SL 5.5mm x 100mm	5706919518210	72	6
1951824	Pro Comfort Screwdriver SL 6.5mm x 150mm with Hex Bolster	5706919518241	72	6
1951825	Pro Comfort Screwdriver SL 8mm x 150mm with Hex Bolster	5706919518258	48	6
1951826	Pro Comfort Screwdriver SL 8mm x 175mm with Hex Bolster	5706919518265	48	6
1951827	Pro Comfort Screwdriver SL 8mm x 200mm with Hex Bolster	5706919518272	48	6
1951828	Pro Comfort Screwdriver SL 9mm x 200mm with Hex Bolster	5706919518289	48	6

PARALLEL



1951848

ITEM NO.	DESCRIPTION	EAN	MASTER PACK	SHELF PACK
1951842	Pro Comfort Screwdriver PARA 3mm x 100mm	5706919518425	120	6
1951843	Pro Comfort Screwdriver PARA 3 mm x 150mm	5706919518432	120	6
1951844	Pro Comfort Screwdriver PARA 3.5mm x 80mm	5706919518449	120	6
1951845	Pro Comfort Screwdriver PARA 4mm x 100mm	5706919518456	120	6
1951846	Pro Comfort Screwdriver PARA 4mm x 150mm	5706919518463	120	6
1951848	Pro Comfort Screwdriver PARA 5.5mm x 100mm	5706919518487	72	6
1951849	Pro Comfort Screwdriver PARA 5.5mm x 150mm	5706919518494	72	6
1951850	Pro Comfort Screwdriver PARA 6.5mm x 30mm	5706919518500	120	6

TORX



1951857

ITEM NO.	DESCRIPTION	EAN	MASTER PACK	SHELF PACK
1951855	Pro Comfort Screwdrivers T10 x 100mm	5706919518555	72	6
1951856	Pro Comfort Screwdrivers T15 x 100mm	5706919518562	72	6
1951857	Pro Comfort Screwdrivers T20 x 100mm	5706919518579	72	6
1951858	Pro Comfort Screwdrivers T25 x 125mm	5706919518586	72	6
1951859	Pro Comfort Screwdrivers T27 x 125mm	5706919518593	72	6
1951860	Pro Comfort Screwdrivers T30 x 125mm	5706919518609	72	6
1951861	Pro Comfort Screwdrivers T40 x 150mm	5706919518616	48	6

VDE INSULATED SCREWDRIVERS

VDE INSULATED

- VDE INSULATION**
Insulated for electrical work up to 1000V AC
- DUAL MATERIAL TRILOBULAR HANDLE**
Provides an ergonomic grip
- BLACK PHOSPHATE MAGNETIC TIP**
For improved screw alignment, easy driving and extended life of tip
- DUAL MATERIAL INJECTION**
Delivers greater comfort in use
- CHROME-VANADIUM SHAFT**
Includes corrosion protection for longer life of the tool

POZIDRIV

ITEM NO.	DESCRIPTION	EAN	MASTER PACK	SHELF PACK
1951867	Pro Comfort VDE Insulated Screwdriver PZ #0 x 80 mm	5706919518678	120	6
1951866	Pro Comfort VDE Insulated Screwdriver PZ #1 x 100mm	5706919518661	120	6
1951865	Pro Comfort VDE Insulated Screwdriver PZ #2 x 125mm	5706919518654	72	6



PHILLIPS

ITEM NO.	DESCRIPTION	EAN	MASTER PACK	SHELF PACK
1951862	Pro Comfort VDE Insulated Screwdriver PH #0 x 80 mm	5706919518623	120	6
1951863	Pro Comfort VDE Insulated Screwdriver PH #1 x 100mm	5706919518630	120	6
1951864	Pro Comfort VDE Insulated Screwdriver PH #2 x 125mm	5706919518647	72	6



PARALLEL

ITEM NO.	DESCRIPTION	EAN	MASTER PACK	SHELF PACK
1951868	Pro Comfort VDE Insulated Screwdriver PARA 3.5mm x 80mm	5706919518685	120	6
1951869	Pro Comfort VDE Insulated Screwdriver PARA 4mm x 100mm	5706919518692	120	6
1951870	Pro Comfort VDE Insulated Screwdriver PARA 2.5mm x 50mm	5706919518708	120	6
1951881	Pro Comfort VDE Insulated Screwdriver PARA 5.5mm x 150mm	5706919518814	72	6



SCREWDRIVER SETS



1951882



1951883



1951884

ITEM NO.	DESCRIPTION	EAN	MASTER PACK	SHELF PACK
1951882	10pc Pro Comfort Screwdrivers Set: PZ #0 x 80mm, PZ #1 x 100mm, PZ #2 x 30mm, PARA 3mm x 100mm, PH #1 x 100, PH #2 x 125mm, SL 5.5mm x 100mm, SL 6.5mm x 150mm, SL 8mm x 150mm	5706919518821	20	5
1951883	9pc Pro Comfort Screwdrivers Set: PZ #0 x 80mm, PZ #1 x 100mm, PZ #2 x 125mm, PARA 4mm x 100mm, PARA 5.5mm x 150mm, PARA 6.5mm x 30mm, SL 3mm x 80mm, SL 5mm x 100mm, SL 5.5mm x 100mm	5706919518838	20	5
1951884	6pc Pro Comfort VDE Insulated Screwdrivers Set: PARA 2mm x 50mm, PARA 3.5mm x 80mm, PARA 4mm x 100mm, PZ #0 x 80mm, PZ #1 x 100mm, PZ #2 x 125mm	5706919518845	30	5

SPECIALITY SCREWDRIVER SETS



1951885

SPINNING HEADS ON HANDLES for controlled torque in precision work
CHROME-VANADIUM (CR-V) SHAFT includes corrosion protection for longer life of the tool
STORAGE CASE INCLUDED for convenient storage

ITEM NO.	DESCRIPTION	EAN	MASTER PACK	SHELF PACK
1951885	5pc Precision Screwdriver Set: SL 2mm x 50mm x 136mm, SL 2.5mm x 50mm x 136mm, SL 3mm x 50mm x 136mm, PH #00 x 50mm x 136mm, PH #0 x 50mm x 136mm	5706919518852	48	6

SCREWDRIVER ACCESSORIES

The 2-in-1 functionality featured on this accessory allows users to magnetise or demagnetise screwdrivers in seconds.



1953963

ITEM NO.	DESCRIPTION	EAN	MASTER PACK	SHELF PACK
1953963	MAGNETISER / DEMAGNETISER	5706919539635	48	6

HEX KEYS

T HANDLE HEX KEYS

Manufactured from high-strength and durable chrome vanadium steel. Ergonomic design to ease gripping and handling, improving the torque performance. Routed tip finish for better gripping and holding of screws. Special surface treatment to prevent oxidisation and corrosion.

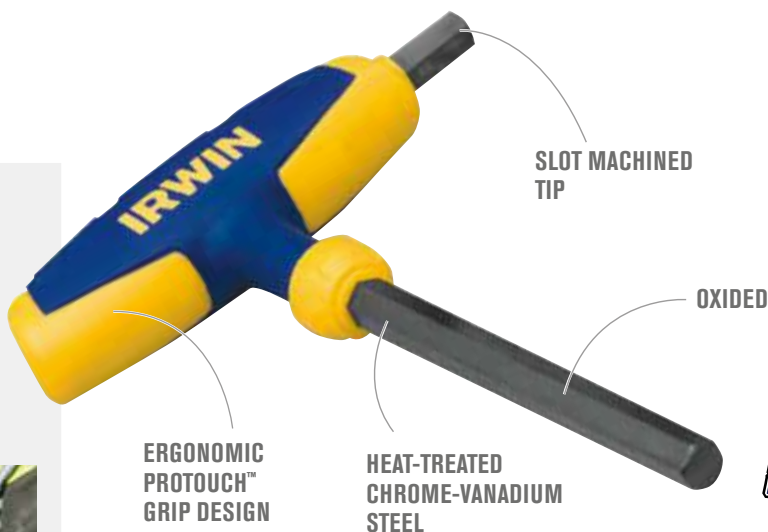

ProTouch
GRIPS

- 1. HEAT-TREATED CHROME-VANADIUM STEEL**
Cr-V with high-resistant heat treatment is high-strength and durable for long tool life
- 2. SLOT MACHINED TIP**
Routed tip finish for better gripping and holding of screws
- 3. ERGONOMIC PROTOUCH™ GRIP DESIGN**
For comfort and better gripping to improve torque performance
- 4. OXIDED**
Special surface treatment to prevent oxidisation and corrosion

'T' HANDLE HEX KEY SETS

ITEM NO.	DESCRIPTION	EAN	MASTER PACK	SHELF PACK
T10771	8pc Set MM: 2.0, 2.5, 3.0, 4.0, 5.0, 6.0, 8.0, 10.0 mm	7897095029299	3	3



T10771

HOLSTER HEX KEYS SET

Durable ABS holster sets available in varying diameters, offer practicality in any use and organize tools compactly.

ITEM NO.	DESCRIPTION	EAN	MASTER PACK	SHELF PACK
T10755	Short Hex Key - MM: 1.5, 2.0, 2.5, 3.0, 4.0, 5.0, 6.0, 7.0, 8.0, 10.0mm	7897095029138	-	6
T10756	Long Hex Key - MM: 1.5, 2.0, 2.5, 3.0, 4.0, 5.0, 6.0, 7.0, 8.0, 10.0mm	7897095029145	-	6
T10757	Ball-Ended Hex Key - MM: 1.5, 2.0, 2.5, 3.0, 4.0, 5.0, 6.0, 7.0, 8.0, 10.0 mm	7897095029152	-	6
T10758	Torx Key: T6, T7, T8, T10, T15, T20, T25, T27, T30, T40	7897095029169	-	6



T10756

HEX AND TORX KEYS - FOLD UP SETS

Retractable set of IRWIN® Hex and Torx keys housed in a high-resistance, polyamide and fiberglass handle. Ergonomic rubber grip for greater comfort and ease of use.

ITEM NO.	DESCRIPTION	EAN	MASTER PACK	SHELF PACK
T10765	Hex Key - MM: 2.0, 2.5, 3.0, 4.0, 5.0, 6.0, 8.0 mm	7897095029237	-	6
T10767	Torx Key: T9, T10, T15, T20, T25, T27, T30, T40	7897095029251	-	6
T10769	Ball - Ended Hex Key - MM: 2.0, 2.5, 3.0, 4.0, 5.0, 6.0, 8.0 mm	7897095029275	-	6
T10768	Ball - Ended Hex Key - IMPERIAL: 9pc. 5/64" - 1/4"	7897095029268	-	6



T10765

STANDARD HEX KEY SETS

The most popular hex key sizes in one set come with permanent size markings for quick identification.

ITEM NO.	DESCRIPTION	EAN	MASTER PACK	SHELF PACK
T10745	Short Hex Key - IMPERIAL: 9pc. 1/16" - 3/8"	7897095029039	-	5
T10747	Ball-Ended Hex Key - IMPERIAL: 9pc. 1/16" - 3/8"	7897095029053	-	5





BI-METAL UTILITY BLADES



SHATTERPROOF

TRAPEZOID BLADES
FIT MOST KNIVES

LAST 3 TIMES
LONGER*

BI-METAL BLUE BLADES

Bi-Metal is formed by welding high-speed steel edge and spring steel, having the benefit of both types: **Safety & Longer Life.**

IRWIN® Bi-metal Blue Blades are safer since they will not break under normal working conditions, and they help reduce the risk of injury from breaking or shattering blades. And, with the blades lasting longer than traditional carbon blades, they result in fewer blade changes which means fewer accidental cuts.

SNAP-OFF BLADES
SOFT SNAP
TECHNOLOGY

1. SHATTERPROOF

Spring steel allows the blade to bend without accidentally breaking

2. LAST 3 TIMES LONGER*

High speed steel hardened cutting edge stays sharp 3X longer than traditional carbon blades which means more cuts for the money

3. TRAPEZOID BLADES FIT MOST KNIVES

Two-notch blade design fits most utility knives

4. SNAP-OFF BLADES SOFT SNAP TECHNOLOGY

For breaking a new edge confidently

3X LONGER LIFE*
*vs. traditional carbon blades



*vs IRWIN® carbon blades 10504245 / 10504561

BI-METAL BLUE TRAPEZOID BLADES

ITEM NO.	DESCRIPTION	EAN	MASTER PACK	SHELF PACK
10504240	Bi-Metal Blue Trapezoid blades - 5pk	5706915042405	25	5
10504241	Bi-Metal Blue Trapezoid blades - 10pk	5706915042412	25	5
10504243	Bi-Metal Blue Trapezoid blades - 100pk, Dispenser	5706915042436	5	1



BI-METAL BLUE SAFETY BLADES

All the benefits of the Bi-Metal Trapezoid Blade but with a snub nose design which helps to reduce the risk of accidental puncture wounds.

ITEM NO.	DESCRIPTION	EAN	MASTER PACK	SHELF PACK
10505823	Bi-Metal 'Blue' Safety Trap Blade 5pk	5706915058239	25	5
10505824	Bi-Metal 'Blue' Safety Trap Blade 50pk, Dispenser	5706915058246	5	1



Bi-Metal Safety Blade - Not Pointed

SNAP-OFF BI-METAL BLUE BLADES

ITEM NO.	DESCRIPTION	EAN	MASTER PACK	SHELF PACK
10507102	Bi-Metal 'Blue' Snap-Off Blade 18mm 5pk	5706915071023	-	10
10507103	Bi-Metal 'Blue' Snap-Off Blade 18mm 8pk	5706915071030	-	10
10507104	Bi-Metal 'Blue' Snap-Off Blade 18mm 50pk	5706915071047	-	2
10507105	Bi-Metal 'Blue' Snap-Off Blade 18mm 10 x 8pk	5706915071054	50	10



CARBON STEEL UTILITY BLADES

CARBON STEEL 4-POINT TRAPEZOID BLADES

This IRWIN® innovation combines the toughness of a traditional trapezoid blade with the increased blade tip life of a snap-off blade. Scored edges give the user 4 sharp points (vs. 2 points on a standard trapezoid blade) which doubles the life of the blade. The 4 notches enable the blade to be extended to maintain blade length after snapping off sections of the blade.

2X LONGER LIFE*
*vs. traditional carbon blades



ITEM NO.	DESCRIPTION	EAN	MASTER PACK	SHELF PACK
2018453	4-Point Carbon Steel Blade - 5pk	5706915184532	100	10
2018454	4-Point Carbon Steel Blade - 10pk	5706915184549	100	10

CARBON STEEL BLADES

Carbon blade with carbon steel cutting edge for general purpose cutting.



ITEM NO.	DESCRIPTION	EAN	MASTER PACK	SHELF PACK
10504245	Carbon Steel Blades - 5pk	5706915042450	-	5
10504246	Carbon Steel Blades - 10pk	5706915042467	-	5
10504247	Carbon Steel Blades - 100pk, Dispenser	5706915042474	-	1

CARBON STEEL HOOKED BLADES

Carbon blade with hooked point to protect surfaces underneath the blade.



ITEM NO.	DESCRIPTION	EAN	MASTER PACK	SHELF PACK
10504249	Carbon Steel Hooked Blades - 5pk	5706915042498	-	5
10504250	Carbon Steel Hooked Blades - 10pk	5706915042504	-	5
10504251	Carbon Steel Hooked Blades - 100pk, Dispenser	5706915042511	-	1

SNAP-OFF CARBON STEEL BLADES

Carbon blade snaps cleanly at the intended point and provides user with a regular sharp new cutting tip.



ITEM NO.	DESCRIPTION	EAN	MASTER PACK	SHELF PACK
10504558	Carbon Steel Snap-Off Blade 25mm 5pk	5706915045581	-	5
10504559	Carbon Steel Snap-Off Blade 25mm 10pk	5706915045598	-	5
10504561	Carbon Steel Snap-Off Blade 18mm 5pk	5706915045611	-	5
10504562	Carbon Steel Snap-Off Blade 18mm 10pk	5706915045628	-	5
10504563	Carbon Steel Snap-Off Blade 18mm 50pk	5706915045635	-	1
10504567	Carbon Steel Snap-Off Blade 9mm 10pk	5706915045673	-	5
10506456	Carbon Steel Snap-Off Blade Bulk 18mm 100pk	5706915064568	-	1

FK SERIES FOLDING UTILITY KNIVES

The IRWIN® Folding Utility Knives range features a new collection of best-in-class knives developed from intensive research on the needs of professional users. This innovative range meets the high standards required by today's professional users – where safety, durability, convenience and comfort are the most important factors.

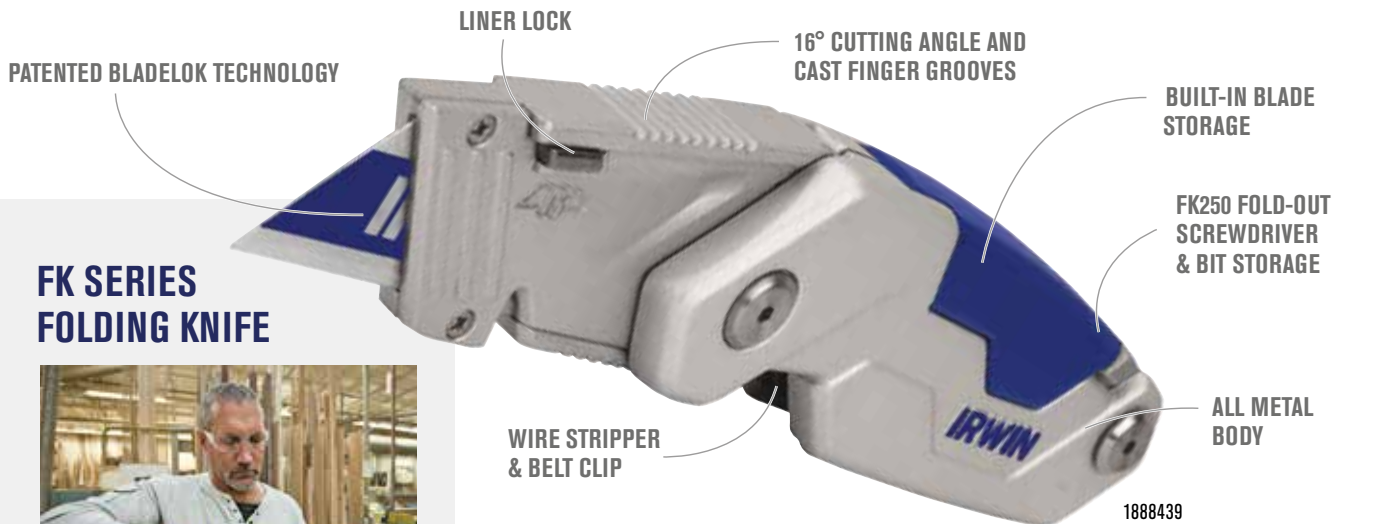

FK SERIES FOLDING KNIFE



Included:



Fold-out Screwdriver and additional bit storage

1. PATENTED BLADELOK TECHNOLOGY

Keeps blade locked in place

2. LINER LOCK

For safe, one-handed operation

3. 16° CUTTING ANGLE AND CAST FINGER GROOVES

For ultimate comfort and control

4. WIRE STRIPPER & BELT CLIP

For built-in convenience

5. BUILT-IN BLADE STORAGE

Holds up to two additional blades (not available on FK100)

6. ALL METAL BODY

Design provides added durability (excluding FK150)

7. FK250 FOLD-OUT SCREWDRIVER & BIT STORAGE

Fits 1" insert bits for quick fixes and provides additional tool versatility (PH2 and SQ2 included)



KEEPS BLADE LOCKED IN



ITEM NO.	DESCRIPTION	EAN	MASTER PACK	SHELF PACK
1888437	FK100 Folding Knife with 1 Bi-metal Blade	5706918884378	-	5
1888438	FK150 Folding Knife with 3 Bi-Metal Blades	5706918884385	-	5
1888439	FK250 Folding Knife with 3 Bi-Metal Blades	5706918884392	-	5



FOLDING KNIFE

This high-quality and compact knife design features a 45° quick-change mechanism to increase both productivity and safety. In addition, the knife features an anchored belt clip, extended thumb ledge, and wire stripper. The knife comes with a Bi-Metal utility blade.

ITEM NO.	DESCRIPTION	EAN	MASTER PACK	SHELF PACK
10507695	Folding Knife	5706915076950	30	10



RETRACTABLE UTILITY KNIVES

IRWIN® offers an extensive range of retractable utility knives designed to be used in a variety of applications and to meet the needs of discerning trade professionals.

PROTOUCH™ X RETRACTABLE UTILITY KNIFE

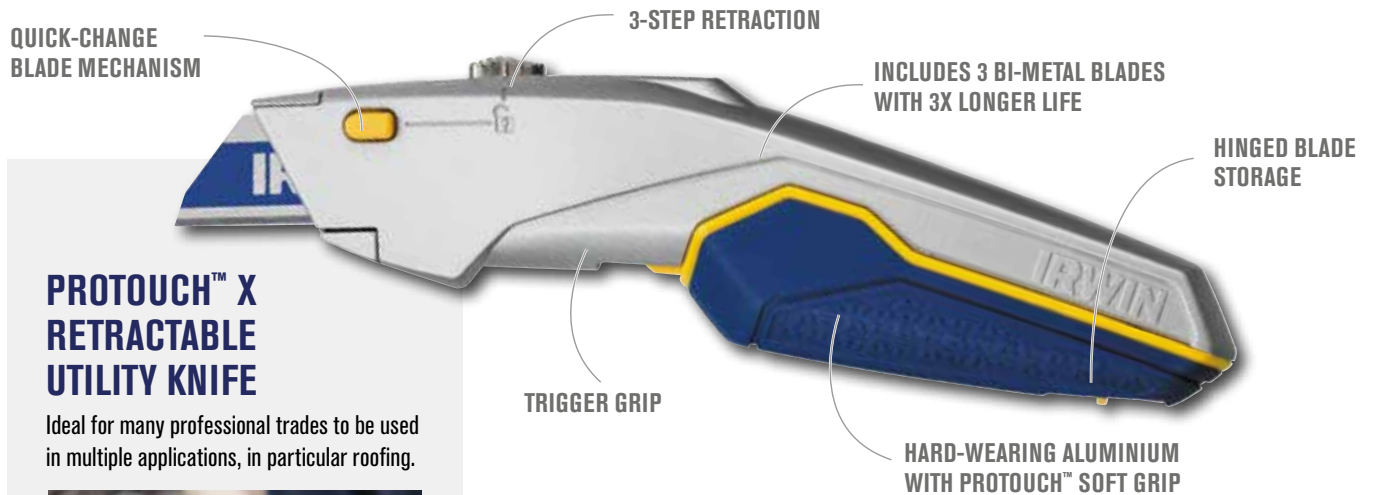

PROTOUCH™ X RETRACTABLE UTILITY KNIFE

Ideal for many professional trades to be used in multiple applications, in particular roofing.



1. QUICK-CHANGE BLADE MECHANISM

Easy blade change with safe lock system to prevent blade from slipping during use

2. HINGED BLADE STORAGE

Tool free access to storage for up to 10 blades

3. TRIGGER GRIP

For cutting on the pull

HARD-WEARING ALUMINIUM WITH PROTOUCH™ SOFT GRIP

PROTOUCH™ SOFT GRIP

Knife is robust, but lightweight with an ergonomic grip for added comfort and to reduce hand fatigue

5. 3-STEP RETRACTION

For multiple cutting depths

6. INCLUDES 3 BI-METAL BLADES WITH 3X LONGER LIFE

vs. traditional carbon blades

4. HARD-WEARING ALUMINIUM WITH



ITEM NO.	DESCRIPTION	EAN	MASTER PACK	SHELF PACK
10508104	ProTouch™ X Retractable Knife	5706915081046	25	5

XP RETRACTABLE KNIFE

This knife, with a single piece steel nose and robust body sets the standard for durability. The quick-change mechanism, easy tool-free entry and 5-blade storage save users time.



ITEM NO.	DESCRIPTION	EAN	MASTER PACK	SHELF PACK
10507404	XP Retractable Knife	5706915074048	40	8

PROTOUCH™ RETRACTABLE KNIFE

This knife has an optimised cutting angle to minimise fatigue and includes magnetic blade retention and storage for up to 5 blades.



ITEM NO.	DESCRIPTION	EAN	MASTER PACK	SHELF PACK
10504236	ProTouch™ Retractable Knife	5706915042368	-	5

GENERAL CONSTRUCTION RETRACTABLE KNIFE

A lightweight and durable retractable knife to get all jobs done. The push and slide opening mechanism provides easy tool-free blade access for quick blade changes, and the knife parts are secured to prevent dropping/losing components.



ITEM NO.	DESCRIPTION	EAN	MASTER PACK	SHELF PACK
10508105	General Contractor Retractable Knife	5706915081053	-	5

PROFESSIONAL RETRACTABLE KNIFE

This general purpose knife has a lightweight, but hard-wearing aluminium body to hold up on the job. A magnet holds the working blade in place and a captive screw prevents loss during blade change.

ITEM NO.	DESCRIPTION	EAN	MASTER PACK	SHELF PACK
10504238	Professional Retractable Knife	5706915042382	-	5



STANDARD RETRACTABLE KNIFE

This professional entry-level retractable knife is highly durable, lightweight, and features an optimised cutting angle for minimal fatigue.

ITEM NO.	DESCRIPTION	EAN	MASTER PACK	SHELF PACK
10507448	Standard Retractable Knife	5706915074482	-	5



FIXED UTILITY KNIVES

PROTOUCH FIXED KNIFE

A feature-rich fixed knife that is designed with an optimised cutting angle to minimise fatigue and a ProTouch™ for a secure grip and greater comfort in use.

ITEM NO.	DESCRIPTION	EAN	MASTER PACK	SHELF PACK
10504237	ProTouch Fixed Knife	5706915042375	-	5



TOOL-FREE ENTRY for easy blade changes
BUILT-IN BLADE STORAGE holds up to 5 blades
MAGNETIC BLADE HOLDER prevents blade from falling out when casing is open
PROTOUCH™ GRIP for comfort and control

DRYWALLER FIXED KNIFE

This professional fixed knife is the ideal tool to be used in drywall cutting applications. It is specially made for working in dusty conditions that normally ruin tools. It is robust and lightweight and the slim nose for scoring makes this product unique.

ITEM NO.	DESCRIPTION	EAN	MASTER PACK	SHELF PACK
10508103	Drywaller Fixed Knife	5706915081039	-	5



PROFESSIONAL FIXED KNIFE

This knife features a strong die cast aluminium body with 19° angled nose for greater comfort and to reduce strain.

ITEM NO.	DESCRIPTION	EAN	MASTER PACK	SHELF PACK
10504239	Professional Fixed Knife	5706915042399	-	5



FIXED KNIFE

This professional entry-level fixed knife is highly durable, lightweight and features an optimised cutting angle for minimal fatigue.

ITEM NO.	DESCRIPTION	EAN	MASTER PACK	SHELF PACK
10507449	Fixed Knife	5706915074499	25	5



SPECIALITY KNIVES

SELF-RETRACTING KNIFE

This knife is designed to minimise the risk of injury.

ITEM NO.	DESCRIPTION	EAN	MASTER PACK	SHELF PACK
10505822	Self Retractable Knife	5706915058222	-	5



SPRING RETURN SHUTTLE ensures blade automatically retracts at the end of a cutting action
STRONG DIECAST ALUMINIUM BODY WITH 19° ANGLED NOSE for more comfortable cutting and to reduce strain
MULTI-FUNCTIONAL DESIGN allows for two blade settings that include normal use and as a box cutter
MAGNETISED BLADE HOLDER prevents blade from falling out
CAPTIVE BALE SCREW for easy tool-free blade changes
BUILT-IN BLADE STORAGE holds up to three blades
INCLUDES 1 SHATTERPROOF BI-METAL SAFETY BLADE WITH 3X LONGER LIFE*

*vs. IRWIN® carbon blades #10504245



PROTOUCH™ SNAP-OFF HEAVY DUTY KNIFE

SLIM NOSE DESIGN

SOLID CAST ALUMINIUM BODY AND STEEL BLADE GUIDE

SELF-LOCKING BLADE SLIDE

PROTOUCH™ SNAP-OFF HEAVY DUTY KNIFE

A feature-rich, heavy-duty knife with manual screw tightening at the nose for user controlled blade security. Other features include cartridge for storing 2 blades, durable cast aluminium body with stainless steel blade guide, hinged end-cap, and ProTouch™ grip for a secure grip and greater comfort.

BLADE STORAGE

PROTOUCH™ GRIP

IMPACT RESISTANT HINGED END-CAP

- 1. SELF-LOCKING BLADE SLIDE**
For fast blade adjustment on medium-duty tasks
- 2. BLADE STORAGE**
For three blades inside the removable cartridge
- 3. SOLID CAST ALUMINIUM BODY AND STEEL BLADE GUIDE**
For durability
- 4. PROTOUCH™ GRIP**
Provides excellent control
- 5. SLIM NOSE DESIGN**
For maximum visibility of the cutting surface
- 6. IMPACT-RESISTANT HINGED END-CAP**
Cannot be separated from knife body



10507106

ITEM NO.	DESCRIPTION	EAN	MASTER PACK	SHELF PACK
10507106	ProTouch™ Snap-Off Heavy-Duty Knife, 18mm	5706915071061	-	8

PROTOUCH™ SNAP-OFF KNIFE

This ProTouch™ knife is designed for a variety of light- to medium-duty applications. The handle provides a secure grip and greater comfort in use and the slim nose design provides accuracy with improved visibility to cutting surfaces.



10504553

ITEM NO.	DESCRIPTION	EAN	MASTER PACK	SHELF PACK
10504553	ProTouch™ Snap-Off Knife, 25mm	5706915045536	-	5
10504555	ProTouch™ Snap-Off Knife 9mm	5706915045550	-	5

PROFESSIONAL SNAP-OFF SCREW KNIFE

This durable snap-off knife features a screw thread for convenient user-controlled blade fixture. Blade storage for two blades inside the removable cartridge. Strong ABS body with steel blade guide. Texture grip provides improved control. Slim nose design for maximum visibility of the cutting surface. Hinged end cap cannot be separated from body.



10507580

ITEM NO.	DESCRIPTION	EAN	MASTER PACK	SHELF PACK
10507580	Professional Screw Knife Bi-Metal Blade - 18mm	5706915075809	-	5

SNAP-OFF SCREW KNIFE

A professional knife featuring a screw fixture for convenient user controlled blade fixture and a strong ABS Body. The textured grip provides improved control.

ITEM NO.	DESCRIPTION	EAN	MASTER PACK	SHELF PACK
10508135	Snap-Off Screw Knife - 18mm	5706915081350	-	5
10508136	Snap-Off Screw Knife - 25mm	5706915081367	-	5



CARPET LAYER SNAP-OFF KNIFE

This knife features a built-in metal carpet tucker for increased versatility. The solid cast aluminium body with steel blade guide provides more durability, and the lightweight and durable handle minimises fatigue. Plus, the screw thread provides convenient user controlled blade fixture.

ITEM NO.	DESCRIPTION	EAN	MASTER PACK	SHELF PACK
10507843	Carpet Layer Snap-Off Knife 18mm	5706915078435	25	5



SNAP-OFF KNIFE

A popular knife format featuring self-locking blade adjustment together with a removable end-cap which can assist breakage of each blade segment.

ITEM NO.	DESCRIPTION	EAN	MASTER PACK	SHELF PACK
10506546	Snap-Off Knife Bulk 9mm 24pk	5706915065466	120	24
10506544	Snap-Off Knife 18mm	5706915065442	-	5
10506547	Snap-Off Knife Bulk 18mm 24pk	5706915065473	120	24
10507446	Snap-Off Knife Bulk with 18mm Bi-Metal Blade 100pk	5706915074468	-	100





STRAIT-LINE®

TAPE MEASURES

PROFESSIONAL TAPE MEASURE RANGE



ProTouch™ GRIPS

- 1. BLADE STAND-OUT**
3m (10ft): 1,4m (4-2/3ft) / 5m (16ft): 1,8m (6ft) / 8m (26ft): 2,3m (7-1/2ft)
- 2. NYLON COATING**
For 2X longer life vs. standard IRWIN® tapes
- 3. 3-RIVET END HOOK**
With reinforced metal backing for durability
- 4. MAGNETIC END HOOK**
For working with metal structures
- 5. FAST LOCK**
For quick and easy blade control
- 6. DOUBLE-SIDED PRINTING**
For greater visibility and convenience
- 7. PROTOUCH™ GRIP**
For comfort in use

ITEM NO.	DESCRIPTION	BLADE WIDTH	EAN	MASTER PACK	SHELF PACK
METRIC					
10507790	Professional 3m Tape Measure	16mm	5706915077902	60	6
10507791	Professional 5m Tape Measure	19mm	5706915077919	60	6
10507792	Professional 8m Tape Measure	25mm	5706915077926	48	6
10508059	Professional 5m Tape Measure, 12pcs Bulk	19mm	5706915080599	-	12
10508060	Professional 8m Tape Measure, 12pcs Bulk	25mm	5706915080605	-	12
METRIC / IMPERIAL					
10507793	Professional 3m/10ft Tape Measure	16mm	5706915077933	60	6
10507794	Professional 5m/16ft Tape Measure	19mm	5706915077940	60	6
10507795	Professional 8m/26ft Tape Measure	25mm	5706915077957	48	6
10508062	Professional 5m/16ft Tape Measure, 12pcs Bulk	19mm	5706915080629	-	12



10507791

STANDARD TAPE MEASURE RANGE



10507788

BLADE STAND-OUT 3m (10ft): 1.2m (4ft) / 5m (16ft): 1.8m (6ft) / 8m (26ft): 2.3m (7-1/2ft)
ACRYLIC COATING for rust and abrasion protection
THREE RIVET END HOOK with reinforced metal backing for durability
SLIDING LOCK for easy blade control
ABS PLASTIC CASE WITH PROTOUCH™ GRIP for comfort and durability

ITEM NO.	DESCRIPTION	BLADE WIDTH	EAN	MASTER PACK	SHELF PACK
METRIC					
10507784	Standard 3m Tape Measure	13mm	5706915077841	60	6
10507785	Standard 5m Tape Measure	19mm	5706915077858	60	6
10507786	Standard 8m Tape Measure	25mm	5706915077865	48	6
10508052	Standard 3m Tape Measure, 12pcs Bulk	13mm	5706915080520	-	12
10508053	Standard 5m Tape Measure, 12pcs Bulk	19mm	5706915080537	-	12
10508054	Standard 8m Tape Measure, 12pcs Bulk	25mm	5706915080544	-	12
METRIC / IMPERIAL					
10507787	Standard 3m/10ft Tape Measure	13mm	5706915077872	60	6
10507788	Standard 5m/16ft Tape Measure	19mm	5706915077889	60	6
10507789	Standard 8m/26ft Tape Measure	25mm	5706915077896	48	6

CHALK REELS

IRWIN® STRAIT-LINE® has manufactured chalk reels designed with the end-user in mind for more than 50 years. The new chalk reel range features larger chalk fill openings designed for ease and speed and delivers best-in-class line strength and reel durability to hold up to jobsite wear and tear.

MACH6™ CHALK REEL

NEW



MACH6™ CHALK REEL



6X FASTER*

*as compared to traditional chalk reels

- 1. EASY FILL & LOCK TOP**
Large, 90°-turn locking top for quick chalk fill and easy access to reel internals
- 2. 6:1 GEAR RATIO**
Rewinds the line 6X faster than traditional chalk reels
- 3. 2.5X STRONGER HI-TENSILE LINE**
For fewer breaks and for use on rough, abrasive surfaces
- 4. OPEN ACCESS BACK PANEL**
Allows for quick line change and cleaning
- 5. METAL DRIVE GEAR**
Resists gear failure under heavy load
- 6. ROBUST STEEL HANDLE & LARGE ERGONOMIC CLUTCH**
For increased durability and torque plus easy line release
- 7. WIDE-PRONG HOOK**
For secure anchoring
- 8. DURABLE ALUMINIUM HOUSING**
Provides impact resistance

ITEM NO.	DESCRIPTION	EAN	MASTER PACK	SHELF PACK
10507681	Strait-Line MACH6™ Chalk Reel 30m/100'	5706915076813	-	6
10507684	MACH6™ Reel 30m/100' + Blue Chalk 113g	5706915076844	-	8



10507684

STRAIT-LINE®

SPEEDLINE PRO™ CHALK REEL



10507676

NEW



2.5X
STRONGER LINE*

3X FASTER*

- EASY FILL & LOCK TOP** for quick chalk fill and easy access to reel internals
- 2.5X STRONGER HI-TENSILE LINE** for fewer breaks
- 3:1 GEAR RATIO** rewinds line 3X faster than traditional chalk reels
- ROBUST STEEL HANDLE & LARGE ERGONOMIC CLUTCH** for increased durability, strength and torque
- WIDE PRONG HOOK** for secure anchoring
- LIGHTWEIGHT ABS HOUSING** withstands jobsite wear and tear

ITEM NO.	DESCRIPTION	EAN	MASTER PACK	SHELF PACK
10507676	SPEEDLINE PRO Chalk Reel 30m/100'	5706915076769	144	6
10507677	SPEEDLINE PRO Chalk Reel 30m/100', 24 pcs, Bulk	5706915076776	-	24
10507682	SPEEDLINE PRO Reel 30m/100' + Blue Chalk 113g	5706915076820	72	3

*vs traditional chalk reels

CLASSIC CHALK REEL



10507678



- 70% WIDER DOOR** for quick and easy chalk fill
- ABRASION RESISTANT LINE** provides 5-6 strikes per pull
- 1:1 GEAR RATIO** rewinds line
- HEAVY-DUTY ALUMINIUM, ROBUST STEEL HANDLE, LARGE CENTER HUB** for increased durability

ITEM NO.	DESCRIPTION	EAN	MASTER PACK	SHELF PACK
10507678	Classic Aluminium Chalk Reel 15m/50'	5706915076783	144	6
10507679	Classic Aluminium Chalk Reel 30m/100'	5706915076790	144	6
10507680	Classic Aluminium Chalk Reel 30m/100', 24 pcs, Bulk	5706915076806	-	24
10507683	Classic Aluminium Reel 30m/100' + Blue Chalk 113g	5706915076837	72	3

MARKING CHALK

IRWIN® STRAIT-LINE® marking chalks have an innovative flip-top cap that keeps the chalk in the bottle where you want it. The flip-top cap seals the chalk in an airtight chamber, keeping out moisture and reducing the risk of clumping.

Marking Chalk Colour Permanence & Application Guide

Blue Chalk - Standard indoor/outdoor (1 week) Red Chalk - Outdoor permanent (up to 2 months).

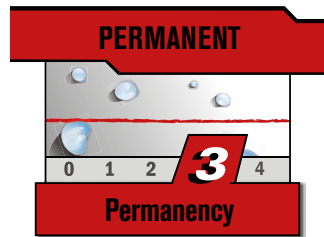
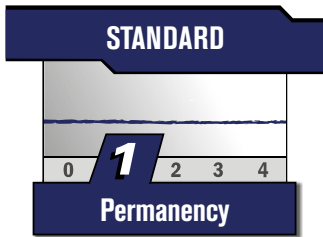

65201



64901



64902

ITEM NO.	DESCRIPTION	EAN	MASTER PACK	SHELF PACK
64801ZR	Blue Marking Chalk 4oz/113g	0024721500014	24	6
64802	Red Marking Chalk 4oz/113g	0024721500052	24	6
64901	Blue Marking Chalk 8oz/227g	0024721500076	24	6
64902	Red Marking Chalk 8oz/227g	0024721500120	24	6
65201	Blue Marking Chalk 2.5lbs/1.1kg	0024721652010	6	1

REPLACEMENT LINES

ITEM NO.	DESCRIPTION	EAN	MASTER PACK	SHELF PACK
1932892	15m/50' Polyester Replacement Line	00042526936913	144	6
1932893	30m/100' Polyester Replacement Line	00042526936920	144	6
1932894	30m/100' Hi-Tensile Replacement Line	00042526936937	144	6



1932894

STRAIT-LINE CRAYONS



66401ZR

ITEM NO.	DESCRIPTION	EAN	MASTER PACK	SHELF PACK
66401ZR	Red Crayon, Bulk 12pk	0024721664013	-	1
66404	Black Crayon, Bulk 12pk	0024721664044	-	1
66406	Yellow Crayon, Bulk 12pk	0024721664068	-	1
666012	Red Crayon, Carded 2 pk	0024721061904	-	12
666042	Black Crayon, Carded 2 pk	0024721061935	-	12
666062	Yellow Crayon, Carded 2 pk	0024721061959	-	12

FOR USE ON OILY, slick, wet, cold or dry surfaces
IDEAL FOR CONCRETE, ceramics, rubber, metal, paper and cardboard
NON-TOXIC and waterproof

STRAIT-LINE CARPENTER PENCILS & SHARPENER



66300

ITEM NO.	DESCRIPTION	EAN	MASTER PACK	SHELF PACK
233250	Carpenter Pencil Sharpener	0024721007087	-	25
66300	Medium Pencil, Bulk 12pcs	0024721663009	144	12
66305SL	Medium Pencil, Box 72pcs	0024721028150	1440	72



















233250



SOFT-SIDED TOOL STORAGE SOLUTIONS: ORGANISE, TRANSPORT AND PROTECT

IRWIN® provides a selection of tool storage in popular formats to fit the needs of tradesmen. Every day on the jobsite, these products deliver an easy, organised and efficient way to carry key tools and hardware while providing protection from the rigours of the trade.

SOFT-SIDED TOOL STORAGE RANGE

	TECH CENTRE	BAGS	TOTES	BACKPACKS	ORGANISERS
COMMANDER SERIES 					
DEFENDER SERIES 		 	 		  
FOUNDATION SERIES			 		

FOUNDATION SERIES

This line sets the foundation for tool storage with:

- Protective rubber feet
- Rugged double-wall 600 denier construction
- Padded grips and straps for comfort
- Metal hardware for strength

DEFENDER SERIES

This tool storage is constructed to last and includes:

- Durable 1680 denier fabric
- Reinforced construction in high stress areas
- Protective integrated moulded or rubber feet
- Improved tool storage options and accessibility
- Enhanced portability with comfort grips and straps

COMMANDER SERIES

This tool bag delivers ultimate tool protection from the elements and environment featuring:

- Waterproof and impact-resistant moulded base
- Durable 1680 denier fabric
- Reinforced construction in high stress areas
- Take-command storage solutions and organisers
- Enhanced portability with comfort grips and straps



IRWIN® PRO TECH CENTRE

HI-VIS DUAL ZIPPERS

DEDICATED TECH STORAGE

PREMIUM-GRADE 1680 DENIER MATERIAL

TAPE MEASURE CLIP & ID HOLDER

STOW-BEHIND FRONT FLAP POCKET

PREMIUM PADDED STRAP

DEDICATED TECHNOLOGY STORAGE

The 400mm/16" IRWIN® PRO Tech Centre is designed to provide dedicated technology storage for safe stowing and transport of electronic devices while on the job. Constructed to last, with premium-grade 1680 denier material in a heavy-duty construction, the bag also includes a fold-down compartment that provides tiered pockets for enhanced tool organisation.



CONSTRUCTED TO LAST.

1680-D

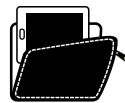

34 POCKETS & SLOTS FOR TECH AND TOOL ORGANISATION

1. DEDICATED TECH STORAGE

Compartment is padded for safe stowing and transport of electronic devices such as laptops or tablets

2. PREMIUM-GRADE 1680 DENIER MATERIAL

In a heavy-duty construction resists wear and tear and moisture for lasting durability

3. TIERED FOLD-DOWN STORAGE

For superior organisation and access

4. TAPE MEASURE CLIP

For quick access

5. ID HOLDER

For easy bag owner identification

6. ZIPPERED INTERIOR POUCH

For secure small part storage

7. PREMIUM PADDED STRAP

For comfortable transport when fully loaded

8. STOW-BEHIND FRONT FLAP POCKET

For storing larger items

9. HI-VIS DUAL ZIPPERS AND POCKET ACCENTS

Help quickly store or access tools

ITEM NO.	DESCRIPTION	DIMENSIONS	WEIGHT	EAN	MOQ
2017825	400mm/16" Defender Series Tech Centre Storage (TC16M)	400 x 250 x 370 mm	1.9 kg	5706915178258	3

IRWIN® MAX TOOL BAG

PREMIUM QUICK-GRAB HANDLE

HI-VIS DUAL ZIPPERS

PREMIUM-GRADE 1680 DENIER MATERIAL

STRAPS FOR OVERSIZED ITEMS



TAPE MEASURE CLIP



WATERPROOF HARD BASE

PREMIUM PADDED STRAP

PASS-THROUGH ZIPPERED COMPARTMENT

THE ULTIMATE IN TOOL PROTECTION

The 450mm/18" IRWIN® MAX Tool Bag provides maximum storage and protection in a tool bag. Its waterproof, impact-resistant base and premium-grade 1680 denier heavy-duty construction means this bag will provide the ultimate protection for its contents. Innovative storage solutions such as a pass-through zippered compartment, removable small parts pouch, and straps for oversized items, plus 25 pockets and tool slots, will keep pros organised for any job.



25 POCKETS & SLOTS FOR TOOL ORGANISATION

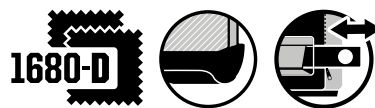

1. WATERPROOF HARD BASE

Is impact-resistant and protects bag and contents

2. PREMIUM-GRADE 1680 DENIER MATERIAL

In a heavy-duty construction resists wear and tear and moisture for lasting durability

3. PASS-THROUGH ZIPPERED COMPARTMENT

For oversized items or hidden tool storage

4. REMOVABLE SMALL PARTS POUCH

For added convenience and safe storage of easy-to-lose items

5. PREMIUM QUICK-GRAB HANDLE

For easy transport

6. STRAPS WITH HOOK & LOOP FASTENING

Designed for securing a level or oversized item

7. TAPE MEASURE CLIP

For quick access

8. HI-VIS DUAL ZIPPERS AND POCKET ACCENTS

Help quickly store or access tools

ITEM NO.	DESCRIPTION	DIMENSIONS	WEIGHT	EAN	MOQ
2017350	450mm/18" Commander Series Bag (B18H)	450 x 275 x 600 mm	2.3 kg	5706915173505	2



IRWIN® PRO TOOL BAGS

DEFENDER SERIES



23 POCKETS & SLOTS FOR TOOL ORGANISATION

1680-D



CONSTRUCTED TO LAST.

- PREMIUM-GRADE 1680 DENIER MATERIAL** in a heavy-duty construction resists wear and tear and moisture for lasting durability
- INTEGRATED MOULDED FEET** protect bag and tools from moisture and jobsite debris
- RIVETED COMFORT GRIP HANDLE** for easy carrying
- TAPE MEASURE CLIP** for quick access
- PREMIUM PADDED STRAP** for comfortable transport when fully loaded
- STOW-BEHIND FRONT FLAP POCKET** for storing larger items
- ZIPPERED INTERIOR POUCH** for secure small part storage
- HI-VIS DUAL ZIPPERS AND POCKET ACCENTS** help quickly store or access tools

ITEM NO.	DESCRIPTION	DIMENSIONS	WEIGHT	EAN	MOQ
2017823	450mm/18" Defender Series Bag (B18M)	450 x 230 x 330 mm	1.9 kg	5706915178234	3
2017824	550mm/22" Defender Series Bag (B22M)	550 x 300 x 300 mm	2.3 kg	5706915178241	2



29 POCKETS & SLOTS FOR TOOL ORGANISATION

1680-D



CONSTRUCTED TO LAST.

IRWIN® TOOL BAG

FOUNDATION SERIES



14 POCKETS & SLOTS FOR TOOL ORGANISATION

600-D

- RUGGED DOUBLE-WALL CONSTRUCTION** and 600-Denier water-resistant material provide lasting protection
- RUBBER FEET** protect the bottom of the bag
- WIDE STAY-OPEN MOUTH** for improved tool access
- REINFORCED STITCHING** in high-stress areas for added durability
- PADDED ADJUSTABLE SHOULDER STRAP** for comfortable transport
- ALL METAL HARDWARE** for strength and resistance to rigours of use

ITEM NO.	DESCRIPTION	DIMENSIONS	WEIGHT	EAN	MOQ
2017831	400mm/16" Foundation Series Bag (B16O)	400 x 250 x 300 mm	1.1 kg	5706915178319	6

IRWIN® PRO ELECTRICIAN'S TOTE

RUBBER GRIP
DETACHABLE HANDLE

PREMIUM-GRADE 1680
DENIER MATERIAL

TAPE LOOP

SMALL PARTS
HARD CASE



TAPE MEASURE
CLIP



INTEGRATED
MOULDED FEET

PREMIUM
PADDED STRAP

CONSTRUCTED
TO LAST.

TOOL STORAGE CONSTRUCTED TO LAST

The 250mm/10" IRWIN® PRO Electrician's Tote is constructed to last with premium-grade 1680 denier material in a heavy-duty construction and integrated moulded feet. It provides ample tool storage with 12 exterior pockets, 5 exterior slots, 20 interior pockets and slots as well as a separate hard case for small parts storage. A rubber grip detachable handle provides full access to the tote's contents, and a premium padded strap allows for easy and comfortable transport.



37 POCKETS & SLOTS FOR
TOOL ORGANISATION

- 1. PREMIUM-GRADE 1680 DENIER MATERIAL**
In a heavy-duty construction resists wear and tear and moisture for lasting durability
- 2. INTEGRATED MOULDED FEET**
Protect bag and tools from moisture and jobsite debris
- 3. SMALL PARTS HARD CASE**
Offers removable, compartmental storage for screws, nails and other hardware
- 4. RUBBER GRIP DETACHABLE HANDLE**
For comfort and access

- 5. TAPE MEASURE CLIP**
For quick access
- 6. PREMIUM PADDED STRAP**
For comfortable transport when fully loaded
- 7. LOOP FOR FAST ACCESS**
To items like electrical tape
- 8. HI-VIS DUAL ZIPPERS AND POCKET ACCENTS**
Help quickly store or access tools



ITEM NO.	DESCRIPTION	DIMENSIONS	WEIGHT	EAN	MOQ
2017821	250mm/10" Defender Series Electrician's Tote (T10M)	250 x 275 x 400 mm	1.9 kg	5706915178210	4

IRWIN® PRO TOOL TOTE DEFENDER SERIES



34 POCKETS & SLOTS FOR TOOL ORGANISATION



CONSTRUCTED TO LAST.

- PREMIUM-GRADE 1680 DENIER MATERIAL** in a heavy-duty construction resists wear and tear and moisture for lasting durability
- INTEGRATED MOULDED FEET** protect bag and tools from moisture and jobsite debris
- COMFORT GRIP HANDLE PIVOTS** for easy tool access
- TAPE MEASURE CLIP** for quick access
- PREMIUM PADDED STRAP** for comfortable transport when fully loaded
- EXTERIOR CARGO POCKETS WITH FLAP CLOSURE** for quick access to small items
- HI-VIS DUAL ZIPPERS AND POCKET ACCENTS** help quickly store or access tools

ITEM NO.	DESCRIPTION	DIMENSIONS	WEIGHT	EAN	MOQ
2017822	500mm/20" Defender Series Tote (T20M)	500 x 250 x 275 mm	3.1 kg	5706915178227	2

IRWIN® TOOL TOTES FOUNDATION SERIES



11 POCKETS & SLOTS FOR TOOL ORGANISATION

12 POCKETS & SLOTS FOR TOOL ORGANISATION

- RUGGED DOUBLE-WALL CONSTRUCTION** and 600 Denier water-resistant material provide lasting protection
- RUBBER FEET** protect the bottom of the bag
- OPEN MAIN COMPARTMENT** for easy tool access
- STURDY METAL HANDLE WITH PADDED COMFORT GRIP** for secure and comfortable transport
- ALL METAL HARDWARE** for strength and resistance to rigours of use

ITEM NO.	DESCRIPTION	DIMENSIONS	WEIGHT	EAN	MOQ
2017828	380mm/15" Foundation Series Tote (T150)	380 x 175 x 250 mm	1.4 kg	5706915178289	4
2017829	450mm/18" Foundation Series Tote (T180)	450 x 215 x 250 mm	1.8 kg	5706915178296	3



IRWIN® PRO BACKPACK

DEFENDER SERIES



CONSTRUCTED TO LAST.

30 POCKETS & SLOTS FOR TOOL ORGANISATION



ITEM NO.	DESCRIPTION	DIMENSIONS	WEIGHT	EAN	MOQ
2017826	Defender Series Backpack (BP14M)	330 x 175 x 470 mm	1.9 kg	5706915178265	4



PREMIUM-GRADE 1680 DENIER MATERIAL in a heavy-duty construction resists wear and tear and moisture for lasting durability

BREATHABLE PADDED BACK AND STRAPS for comfort in transport

RUBBER FEET protect the bottom of the bag

TAPE MEASURE CLIP for quick access

ZIPPERED INTERIOR & EXTERIOR POUCHES for secure small part storage

STOW-BEHIND FRONT FLAP POCKET for storing larger items

HI-VIS DUAL ZIPPERS AND POCKET ACCENTS help quickly store or access tools

IRWIN® BACKPACK

FOUNDATION SERIES



19 POCKETS & SLOTS FOR TOOL ORGANISATION



ITEM NO.	DESCRIPTION	DIMENSIONS	WEIGHT	EAN	MOQ
2017832	Foundation Series Backpack (BP140)	380 x 165 x 485 mm	1.4 kg	5706915178326	6



RUGGED DOUBLE-WALL CONSTRUCTION and 600 denier water-resistant material provide lasting protection

BREATHABLE PADDED BACK AND STRAPS for comfort in transport

RUBBER FEET protect the bottom of the bag

REINFORCED STITCHING in high-stress areas for added durability

ALL METAL HARDWARE for strength and resistance to rigours of use

IRWIN® PRO SMALL PARTS ORGANISERS



CONSTRUCTED TO LAST.



ITEM NO.	DESCRIPTION	DIMENSIONS	WEIGHT	EAN	MOQ
2017827	3pc Small Parts Organiser (SO)	-	0.2 kg	5706915178272	6
	Bag 1	215 x 13 x 125 mm	-	-	-
	Bag 2	175 x 13 x 100 mm	-	-	-
	Bag 3	165 x 13 x 100 mm	-	-	-



PREMIUM-GRADE 1680 DENIER MATERIAL in a heavy-duty construction resists wear and tear and moisture for lasting durability

THREE BAG SIZES for convenient small parts organisation

CONNECTING CARABINER to secure bags together or to other storage items

COATED MESH INSET for visibility to contents





PROFESSIONAL KNEEPADS

I-GEL™ KNEEPADS

These comfortable and safe kneepads are made of perforated Neoprene material with impact resistant I-Gel inserts. The double straps do not restrict blood flow and the pads are notched for comfort when standing.

ITEM NO.	DESCRIPTION	EAN	MASTER PACK	SHELF PACK
10503830	I-Gel™ Kneepads	5706915038309	6	6

ALL-TERRAIN KNEEPADS

Wide-body keeps stance more stable on uneven surfaces. Foam cushion under pad protects knee from rough surfaces.

ITEM NO.	DESCRIPTION	EAN	MASTER PACK	SHELF PACK
10503831	All-Terrain Kneepads	5706915038316	6	6

SWIVEL-FLEX KNEEPADS

Convex cap design provides better pivoting and less resistance, giving greater manoeuvrability across textured surfaces.

ITEM NO.	DESCRIPTION	EAN	MASTER PACK	SHELF PACK
10503832	Swivel-Flex Kneepads	5706915038323	6	6



PROFESSIONAL WORK GLOVES

GENERAL CONSTRUCTION GLOVES

The construction gloves feature two layers of synthetic suede on the palm, thumb and fingers for comfort and extended wear. The rubberised finger tips provide better gripping and the knuckles are padded with perforated Neoprene for breathability and protection. The gloves are form-fitted for improved fit and dexterity.

ITEM NO.	DESCRIPTION	EAN	MASTER PACK	SHELF PACK
10503822	General Construction Gloves, L	5706915038224	24	6
10503823	General Construction Gloves, XL	5706915038231	24	6



EXTREME CONDITIONS GLOVES

These gloves, designed for extreme conditions, are made from a fleece lined stretch material for added warmth and better fit with a non-slip reinforced palm, thumb and fingertips and form-fitting, breathable stretch materials added for comfort. Also, they include a convenient terry cloth insert for brow wipes.

ITEM NO.	DESCRIPTION	EAN	MASTER PACK	SHELF PACK
10503824	Extreme Conditions Gloves, L	5706915038248	24	6
10503825	Extreme Conditions Gloves, XL	5706915038255	24	6



HEAVY-DUTY JOBSITE GLOVES

These gloves are designed for harsh applications and rough materials, without losing dexterity. The grip-reinforced palm, thumb and fingertips provide extra durability. Knuckles are padded with perforated Neoprene for breathability and protection.

ITEM NO.	DESCRIPTION	EAN	MASTER PACK	SHELF PACK
10503826	Heavy-Duty Jobsite Gloves, L	5706915038262	24	6
10503827	Heavy-Duty Jobsite Gloves, XL	5706915038279	24	6



CARPENTER GLOVES

The carpenter gloves have an open finger design to allow for better dexterity. Their reinforced palm, thumb and fingertips provide extra durability and protection. Knuckles are padded with perforated Neoprene for breathability and protection.

ITEM NO.	DESCRIPTION	EAN	MASTER PACK	SHELF PACK
10503828	Carpenter Gloves, L	5706915038286	24	6
10503829	Carpenter Gloves, XL	5706915038293	24	6





PIPE AND TUBE BENDERS

With the IRWIN® range of tube benders, you can be ready to tackle any job with ease. All machines feature precision tooling to give a smooth, accurate bend every time across a large range of sizes.

GLM HAND BENDING MACHINE



GLM HAND BENDING MACHINE



- FORMERS SUPPORTED ON BOTH SIDES**
Prevents twisting under heavy loading
- DURABLE, HARD-WEARING STEEL ROLLERS**
Last much longer than aluminium
- SOLID LUG**
Allows the pipe bender to be held firmly between vice jaws
- HEAVY-GAUGE FORMERS (15mm & 22mm)**
Won't lose their shape and include degree marks on the casting for 'at-a-glance' accuracy
- FLAT EDGES TO THE BRACKET ARM**
Allow the GLM to be used in workshop vice for convenient bending
- HANDLE END STOPS WITH STEEL INSERTS**
Protect user hands during bending, eliminate piercing and increase durability

ITEM NO.	DESCRIPTION	EAN	MASTER PACK	SHELF PACK
T591057	GLM Hand Bending Machine 15/22mm	0686182000016	-	1
T660032	Hook stop and bolt for GLM	0686182001006	-	1



MULTI-MINI HAND BENDER

The IRWIN® Multi-Mini bender is a small lightweight bender that is able to bend 6, 8 & 10mm copper tube in one convenient machine. The Multi-Mini is able to produce bends of 180°

ITEM NO.	DESCRIPTION	EAN	MASTER PACK	SHELF PACK
T676810	Multi-Mini Tube Bender 6, 8, 10mm (Root Radii 22.5, 20 & 15mm)	0686182000061	-	8



ROLLER PIPE CUTTERS

Designed to cut steel pipe, this tool has one fast cutting wheel and two wide rollers. As well as keeping the cutter squarely on track, the rollers smooth down the surface leaving a clean-cut ready for jointing or threading.

T202



ITEM NO.	DESCRIPTION	EAN	MASTER PACK	SHELF PACK
T202	Roller Pipe Cutter, 1/8"-2" (10-60mm)	0734442115564	-	1
T202DF	Roller with Pin T202	0734442137641	-	1
T202EF	Wheel with Pin T202	0734442131526	-	1

TUBE CUTTERS AND SPARE WHEELS

Exceptionally thin, fast cutting wheel and two rollers to ensure the cutting wheel is held squarely on the tube resulting in a square cut. Fitted with wide rollers to hold the tube square against the cutting wheel to prevent "tramlining."



T20030C

ITEM NO.	DESCRIPTION	EAN	MASTER PACK	SHELF PACK
T20030C	Tube Cutter, 3-30mm	0734442118084	-	6
T20045	Tube Cutter, 15-45mm	0734442118183	-	4
T20030CD	Wheel for Tube Cutter T20030C	0734442117964	-	1
T20045D	Wheel for Tube Cutter T20045	0734442132004	-	1

PLASTIC PIPE CUTTERS

The T850026 pipe cutter features a "V" shaped blade which allows for off-centre motion reducing tube deformation. The specially hardened steel blade also gives greater cutting pressure with less effort making it easier to use. The IRWIN® PVC cutter has a simple one-handed ratcheting operation that provides smooth cutting and clean pipe ends. Plus, the rubberised grips provide confident, safe handling.

T850026



10507485

ITEM NO.	DESCRIPTION	EAN	MASTER PACK	SHELF PACK
T850026	26mm Plastic Pipe Cutter	0686182000221	-	10
10507485	45mm PVC Tube Cutter	5706915074857	-	4

TUBE BENDERS

This tube bender is made from strong precision die-castings with integral formers and guides. This makes it lightweight, easy to use and accurate. Each of the benders is suitable for bending three sizes of copper, brass, aluminium or steel tubing.

T210



ITEM NO.	DESCRIPTION	EAN	MASTER PACK	SHELF PACK
T210	Mini Tube Bender 3, 4, 6mm Copper	0734442144052	48	4

MANUAL BENDING MACHINES

EL RANGE CONDUIT BENDING MACHINES AND SPARE PARTS

The IRWIN® EL range is easily portable and the EL25 is the lightest conduit bender available and will fit into most car boots.



ITEM NO.	DESCRIPTION	EAN	MASTER PACK	SHELF PACK
T090700	EL25 Machine & Pipe Vice	0686182000580	-	1
T090700B	EL25 & Vice + 20 / 25mm Formers	0686182000566	-	1
T113100D	EL32 & Vice + 20 / 25 / 32mm Formers	0686182000634	-	1
T090751	Stop bar for EL25	0686182000726	-	1
T620103	Tube stop for EL25, EL32	0686182000702	-	1
T120422	Centre pin for EL25, EL32	0686182000740	-	1
T113112	Bending lever with roller for EL25, EL32	0686182000733	-	1
T102010	Grooved roller for EL25, EL32	0686182000696	-	1
T120465	Roller pin for EL25, EL32	0686182000757	-	1
T090757	Safety pin and chain for EL25, EL32	0686182000689	-	1
T529827	"Terry" retaining pins (in packs of 5 pins) for EL25, EL32	0686182000771	-	1

CONDOBEND AND SPARE PARTS

The unique IRWIN® Condubend is a 20 & 25mm conduit bender all-in-one. Complete with in-built carrying handle and precision tough aluminium former that makes it an easily portable machine.

ITEM NO.	DESCRIPTION	EAN	MASTER PACK	SHELF PACK
T702025	Condubend (Std Vice)	0686182000795	-	1
T660084	Centre pin and circlips for Condubend	0686182000856	-	1



CM RANGE COPPER BENDING MACHINES AND SPARE PARTS

The CM range of tube benders are easily portable with in-built carrying handles, they are used with aluminium formers making them the lightest machines available.

ITEM NO.	DESCRIPTION	EAN	MASTER PACK	SHELF PACK
T620100A	CM35 Machine only	0686182002706	-	1
T620100J	CM35 & 15, 22, 28mm Tooling	0686182000078	-	1
T630500A	CM42 Machine only	0686182002843	-	1
T620103	Tube stop for CM35, CM42	0686182000702	-	1
T120422	Centre pin for CM35, CM42	0686182000740	-	1
T630519	Bending lever assembly for CM35, CM42	0686182000900	-	1
T090757	Safety pin and chain for CM35, CM42	0686182000689	-	1
T529827	"Terry" retaining pins (in packs of 5 pins) for CM35, CM42	0686182000771	-	1



HEAVY-DUTY UNIVERSAL PORTABLE BENDER AND SPARE PARTS

This bender is known for its versatility due to a single universal roller for all forms of pipe. The dual position tube locations are set for copper and conduit, and an adjustable quadrant gives precise repeatable bends.

ITEM NO.	DESCRIPTION	EAN	MASTER PACK	SHELF PACK
TUL223	Universal Portable Bender, Machine Only	0734442144489	6	1
T620103	Tube stop for TUL223	0686182000702	-	1
T220D	Tube locator arm pin with spring for TUL223	0734442171003	-	1



ONLINE SERVICE

www.2helpu.com

Access the latest IRWIN service information and technical data, available 24/7 with frequent updates on new and existing products.

Visit our service website for:

- Authorised IRWIN spare parts stockists
- The latest information about spare parts
- Drawings, exploded views and instruction manuals for all IRWIN tools
- Our warranty policy





MASONRY DRILLING

A DRILL BIT FOR EVERY MATERIAL

		SPEEDHAMMER PLUS	SPEEDHAMMER QUAD	SPEEDHAMMER MAX	MASONRY	GRANITE	CORDLESS MULTI	GLASS & TILE	DIAMOND	HSS PRO	HSS COBALT	HSS TIN	TCT	TURBOMAX	STEP DRILL	BLUE GROOVE 4X/6X	BLUE GROOVE POWER	AUGER BITS	BRAD POINT
		HAMMER DRILL BITS			ROTARY DRILL BITS				METAL DRILL BITS						WOOD DRILL BITS				
PAGE		107	105	111	115	116	114	117	117	126	123	125	131	121	130	135	134	140	138
MASONRY																			
	REBAR REINFORCED CONCRETE	○	●	●		○													
	CONCRETE	●	●	●	●	●	○												
	NATURAL STONE	●	●	●	●	●	○												
	CONCRETE BLOCKS	●	●	●	●	●	○												
	AERATED CONCRETE	●	●	●	●	●	●									○	○		
	BRICK	●	●	●	●	●	●												
	HOLLOW BRICK	○	●	○	●	●	●	○											
	ROOF TILE	○	○		○	○	●	○											
	GYPSUM BOARD	○	○		●	●	●									○	○		
	FIBER CEMENT BOARD	○	○		●	○	●												
	GRANITE	○	●	○	●	●	○		●										
	MARBLE	○	○	○	○	●	●	○	●										
	SLATE	○	○		●	●	●	○	●										
	ETERMIT	○	○		●	○	●	●											
	CERAMIC TILE				○	○	●	●	●										
	HARD DENSITY TILE						●		●										
	GLASS						○	●											
WOOD & BOARD MATERIALS																			
	SOFT WOOD						●			○	○	○	○	●		●	●	●	●
	HARD WOOD						●			○	○	○	○	●		●	●	●	●
	NAIL-EMBEDDED WOOD									○	○	○	○	○			●		
	CHIPBOARD						●			○	○	○	○	●		○	○	○	●
	LAMINATED						●			○	○	○	○	●		○	○	○	●
METAL & PLASTIC																			
	MILD STEEL									●	○	●	○	●	●				
	HIGH-ALLOYED STEEL									○	●	●	●	○	○				
	SHEET METAL						●			●	●	●	○	●	●				
	STAINLESS STEEL									○	●	○	○	○	○				
	CAST IRON						●			○	●	○	●	○					
	ALUMINIUM						●			●	○	●	○	●	●				
	NON-FERROUS METAL						●			●	○	●	○	●	●				
	PLASTICS						●			●	○	●		●	●				

● = Especially suitable. Recommended for this material.
○ = Suitable

IRWIN® Drill Bits are available in sets. Please see product pages for more details.



The origins of Joran® go back to May 1944 at which time, good friends Paul Jensen and Herman Reinholdt formed the company Jensen and Reinholdt in Hvidovre, Denmark. They initially began producing masonry drill bits and later in 1955 expanded the production line to hammer drill bits.

Both product lines were characterised by uncompromising quality and were mainly offered to the building and construction industry. IRWIN® is committed to continue the original values of these products by delivering state of the art of Power Tool Accessories. The masonry drill bits range is no exception to this, and continues to fulfill the highest industry standards.

The Joran SPEEDHAMMER™ Plus and SPEEDHAMMER™ Quad have the certification of "Prüfgemeinschaft Mauerbohrer" e.V. (PGM®), which is the official and independent marking validating the standards of masonry drill bits. The mark is granted only to manufacturers fulfilling the following:

- state-of-the-art manufacturing under use of a quality assurance system
- yearly inspections of the produced drill bits by independent institutes

The inspection requirements are developed by the national approval bodies for anchors in co-operation with leading manufacturers of masonry drill bits and anchors. The Steering Committee of PGM® also carries out appropriate investigations in order to assure the suitability of masonry drill bits for anchor fixings.

New types of drills bits get the inspection mark only after extensive testing has been carried out, ensuring the required suitability and performance.

HAMMER DRILL BITS



SPEEDHAMMER® QUAD



SPEEDHAMMER® PLUS



SPEEDHAMMER® MAX

ROTARY DRILL BITS



CORDLESS MULTI



MASONRY



GRANITE

CHISELS & SPECIALITY

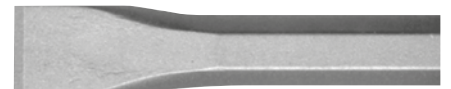

DEMOLITION CHISELS



GLASS AND TILE BITS



MORTAR RAKES



M-SYSTEM

SPEEDHAMMER™ QUAD



SPECIALIST CONCRETE IRWIN® HAMMER DRILL BIT

The range of SPEEDHAMMER™ Quad SDS-plus drill bits is the most powerful masonry bit available from IRWIN®. The unique solid carbide tip* is optimised for fast, continuous drilling, even through reinforced concrete, delivering superior performance and longer life†. The SPEEDHAMMER™ Quad bit has a high performance solid carbide tip that's manufactured from European carbide to a unique IRWIN® design. It easily powers through more concrete and rebar than traditional masonry bits. When long life and durability are crucial, depend on the IRWIN® SPEEDHAMMER™ Quad Bit.

* Except 16mm bit

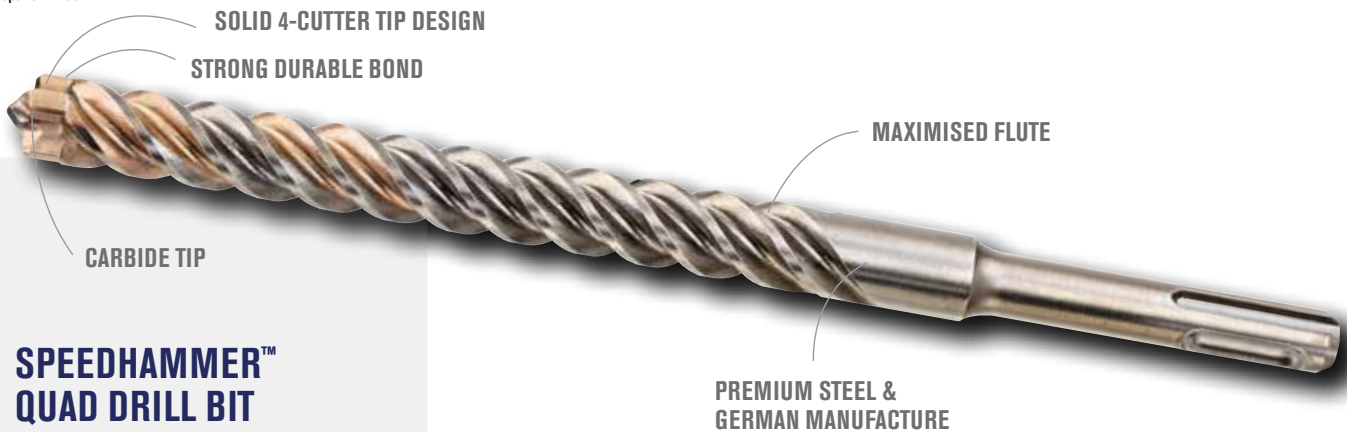

SPEEDHAMMER™ QUAD DRILL BIT



LONGER LIFE†

- 1. CARBIDE TIP**
For longer drilling life and improved durability even through rebar
- 2. SOLID 4-CUTTER TIP**
Reduces vibration and prevents jamming in rebar
- 3. STRONG DURABLE BOND**
The carbide tip and body are brazed together to deliver a strong and durable bond
- 4. MAXIMISED FLUTE**
4 flute spirals aid consistent and efficient dust and debris removal
- 5. PREMIUM STEEL & GERMAN MANUFACTURE**
Provides improved core strength for maximum durability and extended life



MADE IN GERMANY



APPLICATION:

Compatible with all hammer drilling machines with SDS-plus fitment. Optimised for fast, continuous drilling, even through reinforced concrete, delivering superior performance and longer life†.

PGM® AND SDS-PLUS ACCREDITED

The IRWIN® German manufacturing facility is a licensed manufacturer of SDS-plus bits and this along with PGM® accreditation gives users confidence in quality of manufacture and the resultant hole for professional anchor fixing.

SPEEDHAMMER™ Quad drill bits have the certification of Prüfgemeinschaft Mauerbohrer e.V. (PGM®).

BENEFITS OF PGM® MARKED DRILL BITS:

- Strict tolerance limits for the diameter and the symmetry of the carbide tip ensuring the exactness of the drill hole.
- Secure anchoring and fixing.
- Constant quality assurance.
- Safety and confidence in the product.



Adherence to these criteria is constantly controlled by PGM®, making the tool safe and trustworthy for the end user as well as the distributor.

† vs traditional masonry bits

joran®

**SPEED
QUAD
HAMMER**



SPEEDHAMMER™ QUAD DRILL BITS

ITEM NO.	DIAMETER mm	WORKING LENGTH mm	TOTAL LENGTH mm	PIECE PER PACK	EAN	MASTER PACK	SHELF PACK
IW2039099	5.0	50	110	1	5706915390995	-	1
IW2039100	5.0	100	160	1	5706915391008	-	1
IW2039371	5.5	50	110	1	5706915393712	-	1
IW2039372	5.5	100	160	1	5706915393729	-	1
IW2039373	6.0	50	110	1	5706915393736	-	1
IW2039375	6.0	100	160	1	5706915393750	-	1
IW2039376	6.0	150	210	1	5706915393767	-	1
IW2039377	6.0	200	260	1	5706915393774	-	1
IW2039378	6.5	100	160	1	5706915393781	-	1
IW2039379	6.5	150	210	1	5706915393798	-	1
IW2039380	7.0	100	160	1	5706915393804	-	1
IW2039411	7.0	150	210	1	5706915394115	-	1
IW2039412	8.0	100	160	1	5706915394122	-	1
IW2039413	8.0	150	210	1	5706915394139	-	1
IW2039414	8.0	200	260	1	5706915394146	-	1
IW2039415	8.0	250	310	1	5706915394153	-	1
IW2039416	10.0	100	160	1	5706915394160	-	1
IW2039417	10.0	150	210	1	5706915394177	-	1
IW2039418	10.0	200	260	1	5706915394184	-	1
IW2039419	10.0	250	310	1	5706915394191	-	1
IW2039420	10.0	400	460	1	5706915394207	-	1
IW2039421	12.0	100	160	1	5706915394214	-	1
IW2039422	12.0	150	210	1	5706915394221	-	1
IW2039423	12.0	200	260	1	5706915394238	-	1
IW2039424	12.0	250	310	1	5706915394245	-	1
IW2039425	12.0	400	460	1	5706915394252	-	1
IW2039426	14.0	100	160	1	5706915394269	-	1
IW2039427	14.0	150	210	1	5706915394276	-	1
IW2039428	14.0	250	310	1	5706915394283	-	1
IW2039429	14.0	400	460	1	5706915394290	-	1
IW2039430*	16.0	200	250	1	5706915394306	-	1

* 4-cutter. Not solid Head.

SPEEDHAMMER™ PLUS



THE IRWIN® HAMMER DRILL BIT DEDICATED TO SPEED

The innovative design goes straight in and straight out. It removes dust and debris really fast. It's also particularly effective in uncured concrete due to clog-free performance.

INNOVATIVE HEAD AND TIP GEOMETRY

FULLY HARDENED CHROME-VANADIUM STEEL BODY

UNIQUE FLUTE DESIGN

SPEEDHAMMER™ PLUS DRILL BIT



20% FASTER*

- 1. INNOVATIVE HEAD AND TIP GEOMETRY**
Thicker carbide tip improves strength and durability. Aggressive concave cutting angles increase drilling speed by up to 20%. Extra short drill bit head clears drilling dust directly into the flute, reducing the risk of clogging. Self-centering point prevents walking
- 2. UNIQUE FLUTE DESIGN**

New extra deep, asymmetrical flute design provides faster dust removal and increases drilling speed

- 3. FULLY HARDENED CHROME-VANADIUM STEEL BODY**
Resulting in maximum rupture strength and longer life

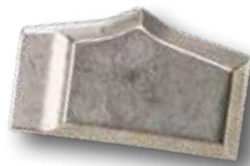

2-Cutter Head

APPLICATION:

Compatible with all hammer drilling machines with SDS-plus fitment. Designed for drilling in concrete, masonry, brick, block, and granite.

DRILLING RECOMMENDATION:

When using drill bits with length over 400mm, pre-drill at least 150mm deep with a shorter drill bit of the same diameter.

SPEEDHAMMER™ Plus drill bits have the certification of Prüfgemeinschaft Mauerbohrer e.V. (PGM®).

BENEFITS OF PGM® MARKED DRILL BITS:

- Strict tolerance limits for the diameter and the symmetry of the carbide tip ensuring the exactness of the drill hole.
- Secure anchoring and fixing.
- Constant quality assurance.
- Safety and confidence in the product.



Adherence to these criteria is constantly controlled by PGM®, making the tool safe and trustworthy for the end user as well as the distributor.

* Up to 20% faster drilling vs. competitor products due to tip geometry and innovative flute design.



10501979

SPEEDHAMMER™ PLUS DRILL BITS

ITEM NO.	DIAMETER mm	WORKING LENGTH mm	TOTAL LENGTH mm	PIECE PER PACK	EAN	MASTER PACK	SHELF PACK
10501942	3.5	50	110	1	5709131061656	200	10
10507575	3.5	80	140	1	5706915075755	100	10
10501943	4.0	50	110	1	5709131019282	200	10
10501944	4.0	100	160	1	5709131019350	200	10
10503844	4.5	100	160	1	0734442175582	200	10
10501945	5.0	50	110	1	5709131019466	200	10
10501946	5.0	100	160	1	5709131019800	200	10
10501947	5.0	150	210	1	5709131236962	100	10
10501948	5.0	200	260	1	5709131204237	100	10
10501949	5.5	50	110	1	5709131020011	200	10
10501950	5.5	100	160	1	5709131020233	200	10
10501951	5.5	150	210	1	5709131020363	100	10
10501952	5.5	200	260	1	5709131281030	100	10
10501953	5.5	240	300	1	5709131236986	100	10
10501954	6.0	50	110	1	5709131020400	200	10
10501955	6.0	100	160	1	5709131020769	200	10
10501956	6.0	150	210	1	5709131021070	100	10
10501957	6.0	200	260	1	5709131021124	100	10
10501958	6.0	240	300	1	5709131236948	100	10
10501959	6.0	400	460	1	5709131021162	50	10
10501960	6.5	50	110	1	5709131021186	200	10
10501961	6.5	100	160	1	5709131021353	200	10
10501962	6.5	150	210	1	5709131021537	100	10
10501963	6.5	200	260	1	5709131021544	100	10
10501964	7.0	50	110	1	5709131021582	200	10
10501965	7.0	100	160	1	5709131021704	200	10
10501966	7.0	150	210	1	5709131021919	100	10
10501967	7.0	340	400	1	5709131228929	50	10
10501968	8.0	50	110	1	5709131021971	200	10
10501969	8.0	100	160	1	5709131022305	200	10
10501970	8.0	150	210	1	5709131022701	100	10
10501971	8.0	200	260	1	5709131022947	100	10
10501972	8.0	240	300	1	5709131023029	100	10
10501973	8.0	400	460	1	5709131023142	50	10
10501974	8.0	540	600	1	5709131023227	50	1
10501975	9.0	100	160	1	5709131023364	200	10
10501976	9.0	150	210	1	5709131023449	100	10
10501978	10.0	50	110	1	5709131023524	200	10
10501979	10.0	100	160	1	5709131023722	200	10
10501980	10.0	150	210	1	5709131024095	100	10
10501981	10.0	200	260	1	5709131024378	100	10
10501982	10.0	240	300	1	5709131024484	100	10
10501984	10.0	400	460	1	5709131024620	50	10
10501985	10.0	540	600	1	5709131024750	50	1
10501986	10.0	940	1000	1	5709131135418	20	1
10501987	11.0	100	160	1	5709131024866	100	10
10501988	11.0	200	260	1	5709131025047	50	10
10501989	11.0	240	300	1	5709131025061	50	10
10501991	12.0	100	160	1	5709131025153	100	10
10501992	12.0	150	210	1	5709131025498	100	10
10501993	12.0	170	230	1	5709131025610	100	10
10501994	12.0	200	260	1	5709131025689	100	10
10501995	12.0	240	300	1	5709131025771	50	10
10501996	12.0	400	460	1	5709131025917	50	10
10501997	12.0	540	600	1	5709131026044	20	1
10501998	12.0	740	800	1	5709131026105	20	1
10501999	12.0	940	1000	1	5709131026112	20	1
10502000	13.0	100	160	1	5709131026280	100	10
10502002	13.0	240	300	1	5709131026488	50	10
10502004	14.0	100	160	1	5709131026624	100	10
10502005	14.0	150	210	1	5709131026778	50	1
10502006	14.0	170	230	1	5709131026846	50	1
10502007	14.0	200	260	1	5709131026907	50	1

SPEEDHAMMER™ PLUS DRILL BITS

ITEM NO.	DIAMETER mm	WORKING LENGTH mm	TOTAL LENGTH mm	PIECE PER PACK	EAN	MASTER PACK	SHELF PACK
10502008	14.0	240	300	1	5709131026983	50	1
10502010	14.0	400	460	1	5709131027058	20	1
10502011	14.0	540	600	1	5709131027188	20	1
10502012	14.0	940	1000	1	5709131137610	20	1
10502013	15.0	100	160	1	5709131027331	100	1
10502014	15.0	170	230	1	5709131027492	50	1
10502015	15.0	200	260	1	5709131027539	50	1
10502016	15.0	240	300	1	5709131027584	40	1
10502017	16.0	100	160	1	5709131027713	100	1
10502018	16.0	150	210	1	5709131027829	50	1
10502019	16.0	170	230	1	5709131027959	50	1
10502020	16.0	240	300	1	5709131028055	40	1
10502021	16.0	400	460	1	5709131028154	20	1
10502022	16.0	540	600	1	5709131028314	20	1
10502023	16.0	740	800	1	5709131028383	20	1
10502024	16.0	940	1000	1	5709131028413	10	1
10502025	17.0	150	210	1	5709131028475	50	1
10502027	18.0	150	210	1	5709131028635	50	1
10502028	18.0	240	300	1	5709131028857	40	1
10502029	18.0	400	460	1	5709131028925	20	1
10502030	18.0	540	600	1	5709131029038	20	1
10502031	18.0	940	1000	1	5709131096290	10	1
10502033	19.0	240	300	1	5709131029205	40	1
10502035	19.0	400	460	1	5709131029267	20	1
10502036	20.0	150	210	1	5709131029373	50	1
10502038	20.0	240	300	1	5709131029595	40	1
10502040	20.0	400	460	1	5709131029670	20	1
10502041	20.0	540	600	1	5709131029823	10	1
10502042	20.0	940	1000	1	5709131097129	10	1
10502043	22.0	200	260	1	5709131029939	25	1
10502044	22.0	240	300	1	5709131030003	40	1
10502046	22.0	400	460	1	5709131030126	10	1
10502047	22.0	540	600	1	5709131030263	10	1
10502048	22.0	940	1000	1	5709131097594	10	1
10502049	24.0	200	260	1	5709131030331	10	1
10502050	24.0	240	300	1	5709131030386	20	1
10502052	24.0	400	460	1	5709131030478	10	1
10502053	25.0	200	260	1	5709131030584	10	1
10502054	25.0	240	300	1	5709131030638	20	1
10502056	25.0	400	460	1	5709131030720	10	1
10502057	25.0	550	600	1	5709131258483	5	1
10502059	26.0	240	300	1	5709131030898	20	1
10502060	26.0	400	460	1	5709131030942	10	1
10502061	26.0	540	600	1	5709131128397	10	1



10502089



IW2039502

SPEEDHAMMER™ PLUS DRILL BIT SETS

ITEM NO.	DESCRIPTION	PIECE PER PACK	EAN	MASTER PACK	SHELF PACK
10502089	SPDH Plus 5pc set: 5/6/8/10/12 x 160mm	5	5709131268871	48	16
IW2039501	SPDH Plus 10pc set in medium case: 5/5.5/6.0 mm x110, 5.5/6/8/10/12 x160mm	10	5054905247782	5	1
IW2039502	PDH Plus 10pc set in medium case: 5/5.5/6 x110, 5.5/6/7/10/12 x160mm	10	5054905247799	5	1



IW2039501

**SPEED
PLUS
HAMMER™**



SPEEDHAMMER™ PLUS DRILL BITS - BULK PACK

10-PIECE PACKS

10502071	5.0	50	110	10	5709131176206	30	1
10502072	5.0	100	160	10	5709131176220	30	1
10502073	5.5	50	110	10	5709131176244	30	1
10502074	5.5	100	160	10	5709131176268	30	1
10502075	6.0	50	110	10	5709131176282	30	1
10502076	6.0	100	160	10	5709131176305	1	1
10502077	6.0	150	210	10	5709131228943	30	1
10502080	6.5	150	210	10	5709131230823	20	1
10503845	7.0	100	160	10	0734442175827	20	1
10502082	8.0	100	160	10	5709131176404	30	1
10502083	8.0	150	210	10	5709131176428	30	1
10502084	10.0	50	110	10	5709131176442	20	1
10502085	10.0	100	160	10	5709131253341	30	1
10502086	10.0	150	210	10	5709131176480	25	1
10502087	12.0	100	160	10	5709131176503	25	1
10502088	12.0	150	210	10	5709131230199	25	1

SPEEDHAMMER™ MAX

SDS-MAX DRILL BITS - DESIGNED FOR TOUGHER TASKS



CARBIDE TIP

SPEED

STRONG AND DURABLE

OPTIMUM IMPACT TRANSMISSION

PREMIUM STEEL & GERMAN MANUFACTURE

1. CARBIDE TIP
Solid 2 cutter head plus 2 individual cutting teeth

2. SPEED
4 flute helix for fast debris removal

3. STRONG AND DURABLE
The carbide tip and body are brazed together to deliver a strong and durable bond

4. OPTIMUM IMPACT TRANSMISSION
Strong central core for improved durability and energy transmission

5. PREMIUM STEEL & GERMAN MANUFACTURE
Provides improved core strength for maximum durability and extended life

MADE IN GERMANY

SPEEDHAMMER™ MAX DRILL BIT



APPLICATION:

Compatible with all hammer drilling machines with **SDS-max fitment**. Optimised for fast and efficient drilling, even through reinforced concrete.

PGM® AND SDS-MAX ACCREDITED

The IRWIN® German manufacturing facility is a licensed manufacturer of SDS-max bits and this along with PGM® accreditation gives users confidence in quality of manufacture and the resultant hole for professional anchor fixing.

SPEEDHAMMER™ Max drill bits have the certification of Prüfgemeinschaft Mauerbohrer e.V. (PGM®).

BENEFITS OF PGM® MARKED DRILL BITS:

- Strict tolerance limits for the diameter and the symmetry of the carbide tip ensuring the exactness of the drill hole.
- Secure anchoring and fixing.
- Constant quality assurance.
- Safety and confidence in the product.



Adherence to these criteria is constantly controlled by PGM®, making the tool safe and trustworthy for the end user as well as the distributor.

joran®

**SPEED
MAX
HAMMER™**



IW2022114

SPEEDHAMMER™ MAX DRILL BITS 4 CUTTING EDGES

ITEM NO.	DIAMETER mm	WORKING LENGTH mm	TOTAL LENGTH mm	PIECE PER PACK	EAN	MASTER PACK	SHELF PACK
IW2022101	16.0	200	340	1	5054905238728	-	1
IW2022102	16.0	400	540	1	5054905238735	-	1
IW2022103	18.0	200	340	1	5054905238742	-	1
IW2022104	18.0	400	540	1	5054905238759	-	1
IW2022105	20.0	200	340	1	5054905238766	-	1
IW2022106	20.0	400	540	1	5054905238773	-	1
IW2022107	20.0	800	920	1	5054905238780	-	1
IW2022108	22.0	200	340	1	5054905238797	-	1
IW2022109	22.0	400	540	1	5054905238803	-	1
IW2022110	22.0	800	920	1	5054905238810	-	1
IW2022111	24.0	200	340	1	5054905238827	-	1
IW2022112	24.0	400	540	1	5054905238834	-	1
IW2022113	25.0	200	340	1	5054905238841	-	1
IW2022114	25.0	400	540	1	5054905238858	-	1
IW2022115	25.0	800	920	1	5054905238865	-	1
IW2022116	28.0	450	570	1	5054905238872	-	1
IW2022117	28.0	550	670	1	5054905238889	-	1
IW2022118	30.0	450	570	1	5054905238896	-	1
IW2022119	32.0	450	570	1	5054905238650	-	1
IW2022120	32.0	800	920	1	5054905238667	-	1
IW2022121	35.0	450	570	1	5054905238674	-	1
IW2022122	35.0	550	670	1	5054905238681	-	1
IW2022123	38.0	450	570	1	5054905238698	-	1
IW2022124	40.0	450	570	1	5054905238704	-	1
IW2022125	40.0	800	920	1	5054905238711	-	1

joran®

DEMOLITION CHISELS

POINTED CHISEL



For general chiselling and breaking work in brick, concrete and loose stone (eg: when laying cables)

FLAT CHISEL



For general chiselling and breaking work in brick, concrete and loose stone (eg: when laying cables)

SPADE CHISEL



For removing large quantities of material

GOUGE CHISEL



For cutting narrow channels into concrete

TCT POINTING CHISEL



For the removal of pointing in brickwork

CRANKED TILE CHISEL



For easy removal of tiles

SPEEDHAMMER™ PLUS DEMOLITION CHISELS

ITEM NO.	DESCRIPTION	PIECES PER PACK	EAN	MASTER PACK	SHELF PACK
10502194	Pointed Chisel 250mm	1	5709131281979	-	1
10502195	Flat Chisel 20 x 250mm	1	5709131281986	-	1
10502196	Spade Chisel 40 x 250mm	1	5709131281993	-	1
10502197	Gouge Chisel 22 x 250mm	1	5709131282006	-	1
10502200	TCT Pointing Chisel 32 x 200mm	1	5709131285601	-	1
10503643	Cranked Tile Chisel 40 x 250mm	1	5706915001273	-	1

DESIGNED FOR A WIDE RANGE OF APPLICATIONS for both SDS Plus and SDS Max hammer drills: breaking through or breaking up concrete, light demolition work and chasing of channels for pipes and electrical conduit

IDEAL FOR DRILLING in concrete and masonry **HIGH-QUALITY ALLOYED STEEL** is precision hardened for optimum performance and life

SPEEDHAMMER™ MAX DEMOLITION CHISELS

ITEM NO.	DESCRIPTION	PIECES PER PACK	EAN	MASTER PACK	SHELF PACK
10502184	Pointed Chisel 280mm	1	5709131281870	-	1
10502185	Pointed Chisel 400mm	1	5709131281887	-	1
10502186	Pointed Chisel 600mm	1	5709131281894	-	1
10502187	Flat Chisel 25 x 280mm	1	5709131281900	-	1
10502188	Flat Chisel 25 x 400mm	1	5709131281917	-	1
10502189	Flat Chisel 25 x 600mm	1	5709131281924	-	1
10502190	Spade Chisel 115 x 350mm	1	5709131281931	-	1
10502191	Spade Chisel 50 x 400mm	1	5709131281948	-	1
10502192	Spade Chisel 80 x 300mm	1	5709131281955	-	1



SPEEDHAMMER™ PLUS DEMOLITION CHISELS SET

ITEM NO.	DESCRIPTION	PIECES PER PACK	EAN	MASTER PACK	SHELF PACK
IW2027601	6 Piece chisel set : 250 Pointed, 40 x 250mm Spade, 20 x 250mm Flat	6	5054905239190	-	1
IW2027602	3 Piece chisel set : 250 Pointed, 40 x 250mm Spade, 20 x 250mm Flat	3	5054905239206	-	1

CORDLESS MULTI DRILL BITS

ONE DRILL BIT FOR EVERY MATERIAL



The IRWIN® Cordless Multi drill bit is the most versatile drill bit. It is designed to drill in multiple materials including brick, light concrete, dry wall, ceramic tiles, sheet metal, wood, plastic and marble. In addition to the multipurpose function, the IRWIN® Cordless Multi is the problem solver for drilling into ceramic tiles up to a hardness grade of 9.

HIGHEST CARBIDE GRADE

SINGLE FLUTE DESIGN

UNIQUE TIP GRINDING

CORDLESS MULTI



- 1. HIGHEST CARBIDE GRADE**
For fast drilling into most common materials and hardest tiles (scratch hardness 9)
- 2. SINGLE FLUTE DESIGN**
Giving maximum space for dust removal. Up to 15% Speed advantage over competition. 10% more holes per battery charge
- 3. UNIQUE TIP GRINDING**
Brazed carbide tip has a unique diamond ground 4-face design for excellent centering and perfect hole quality



USEFUL TIPS:

1. Drill with low RPM
2. High pressure
3. No hammer action

CORDLESS MULTI-DRILL BITS - ROTARY DRILLING ONLY

ITEM NO.	DIAMETER mm	WORKING LENGTH mm	TOTAL LENGTH mm	SHANK DIAMETER mm	EAN	MASTER PACK	SHELF PACK
10501919	3.0	40	110	CYL as Ø	5709131285731	200	10
10501920	3.5	40	110	CYL as Ø	5709131285762	200	10
10501921	4.0	45	80	CYL as Ø	5709131000303	200	10
10501922	5.0	50	90	CYL as Ø	5709131000563	200	10
10501923	5.5	55	95	CYL as Ø	5709131000822	200	10
10501924	5.5	115	160	CYL as Ø	5709131055037	200	10
10501925	6.0	60	100	CYL as Ø	5709131000983	200	10
10501926	6.0	115	160	CYL as Ø	5709131001164	200	10
10501927	6.0	120	200	CYL as Ø	5709131247593	100	10
10501928	6.5	60	105	CYL as Ø	5709131001348	200	10
10501929	6.5	120	200	CYL as Ø	5709131243007	100	10
10501930	7.0	65	110	CYL as Ø	5709131001577	200	10
10501931	7.0	115	160	CYL as Ø	5709131001720	200	10
10501932	8.0	70	120	CYL as Ø	5709131001836	200	10
10501933	8.0	120	200	CYL as Ø	5709131002086	100	10
10501934	10.0	70	140	CYL as Ø	5709131002710	200	10
10501935	10.0	120	200	CYL as Ø	5709131002918	100	10
10501936	12.0	105	160	CYL as Ø	5709131003267	50	10
10501937	14.0	100	160	10	5709131003717	50	10

CORDLESS MULTI DRILL BIT CASSETTES

ITEM NO.	DESCRIPTION	EAN	MASTER PACK	SHELF PACK
10501938	Cordless Multi 5pc set: 4/5/6/8/10mm	5709131247715	48	6
10501939	Cordless Multi 5pc set: 5/5,5/6/8/10mm	5709131247692	48	6
10501940	Cordless Multi 7pc set: 4/5/6/7/8/10/12mm	5709131247708	48	6



10501932



10501938



10501939



10501940

joran®

MASONRY DRILL BITS

FAST AND LONG-LASTING MASONRY DRILL BIT

MASONRY



MASONRY DRILL BITS - ROTARY PERCUSSION

ITEM NO.	DIAMETER mm	WORKING LENGTH mm	TOTAL LENGTH mm	SHANK DIAMETER mm	EAN	MASTER PACK	SHELF PACK
10501812	3.0	45	70	CYL as Ø	5709131000129	200	10
10501813	3.5	45	75	CYL as Ø	5709131000211	200	10
10501814	4.0	45	80	CYL as Ø	5709131055839	200	10
10501815	4.0	90	160	CYL as Ø	5709131055075	200	10
10501816	4.5	45	85	CYL as Ø	5709131000488	200	10
10501817	5.0	50	90	CYL as Ø	5709131055846	200	10
10501818	5.0	90	160	CYL as Ø	5709131000778	200	10
10501819	5.5	50	95	CYL as Ø	5709131055853	200	10
10501820	5.5	90	160	CYL as Ø	5709131000952	200	10
10501821	6.0	60	100	CYL as Ø	5709131055860	200	10
10501822	6.0	90	160	CYL as Ø	5709131055877	200	10
10501824	6.0	300	400	CYL as Ø	5709131001249	50	1
10501826	6.5	60	105	CYL as Ø	5709131055884	200	10
10501827	6.5	90	160	CYL as Ø	5709131001461	50	10
10501830	7.0	60	110	CYL as Ø	5709131055891	200	10
10501831	7.0	90	160	CYL as Ø	5709131055907	200	10
10501834	8.0	70	120	CYL as Ø	5709131055914	200	10
10501835	8.0	90	160	CYL as Ø	5709131002055	200	10
10501836	8.0	130	200	CYL as Ø	5709131055921	100	10
10501838	8.0	300	400	CYL as Ø	5709131002147	50	1
10501841	9.0	70	130	CYL as Ø	5709131002352	200	10
10501846	10.0	70	140	CYL as Ø	5709131055938	200	10
10501847	10.0	90	160	CYL as Ø	5709131002871	200	10
10501848	10.0	130	200	CYL as Ø	5709131055945	100	10
10501850	10.0	300	400	CYL as Ø	5709131002987	50	1
10501853	11.0	90	160	CYL as Ø	5709131003106	50	10
10501854	12.0	90	160	10	5709131055952	50	10
10501856	12.0	300	400	CYL as Ø	5709131003403	30	1
10501859	13.0	90	160	10	5709131003526	30	10
10501862	14.0	90	160	10	5709131055969	50	10
10501864	14.0	300	400	10	5709131003786	30	1
10501866	15.0	90	160	10	5709131003878	50	1
10501867	16.0	90	160	10	5709131003915	15	1
10501869	16.0	300	400	10	5709131003991	15	1
10501873	18.0	95	160	13	5709131004158	50	1
10501874	18.0	300	400	13	5709131004172	15	1
10501878	20.0	95	160	13	5709131004325	10	1

IMPROVED CARBIDE TIP DESIGN ensures for durability and fast drilling in all masonry materials
AGGRESSIVE HEAD DESIGN for up to 15% speed advantage over competition
UNIQUE BRAZING PROCESS ensures a perfect bond between tip and body
SINGLE FLUTE DESIGN gives maximum space for dust removal and provides a 60% faster dust removal

20% LONGER LIFE*



10501812



10501892



10501893

MASONRY DRILL BIT CASSETTES

ITEM NO.	DESCRIPTION	EAN	MASTER PACK	SHELF PACK
10501892	Masonry 5pc set: 4/5/6/8/10mm	5709131248125	48	6
10501893	Masonry 7pc set: 4/5/6/7/8/10/12mm	5709131248149	48	6
IW3031505	Mixed 14pc set in small case: 2/3/3.5/4/6/8mm HSS Cobalt, 4/5/6/8mm masonry bits, 3/4/6/8mm wood bits	5054905247829	5	5

* vs traditional masonry bits

GRANITE DRILL BITS

DESIGNED FOR PERCUSSION DRILLING IN VERY HARD MATERIALS

GRANITE



FOR PERCUSSION DRILLING in very hard materials such as granite

EXTREMELY HARD AND WEAR RESISTANT

CARBIDE guarantees up to 40% more holes compared to conventional masonry drill bits

STONE MASONS favour this product for impact drilling of natural stone like granite

SPECIAL SHAPED CUTTING EDGES mean higher durability resulting in 50% more accurately sized holes per drill bit



10501901

GRANITE DRILL BITS - ROTARY PERCUSSION

ITEM NO.	DIAMETER mm	WORKING LENGTH mm	TOTAL LENGTH mm	SHANK DIAMETER mm	EAN	MASTER PACK	SHELF PACK
10501894	3.0	40	70	CYL as Ø	5709131008095	200	10
10501895	3.5	40	75	CYL as Ø	5709131008101	200	10
10501896	4.0	45	80	CYL as Ø	5709131008118	200	10
10501897	5.0	50	90	CYL as Ø	5709131008163	200	10
10501898	5.0	115	160	CYL as Ø	5709131008187	200	10
10501899	5.5	55	95	CYL as Ø	5709131008200	200	10
10501901	6.0	60	100	CYL as Ø	5709131008231	200	10
10501902	6.0	115	160	CYL as Ø	5709131008255	200	10
10501903	6.5	60	105	CYL as Ø	5709131008293	200	10
10501905	7.0	60	110	CYL as Ø	5709131008323	200	10
10501906	7.0	115	160	CYL as Ø	5709131008347	200	10
10501907	8.0	70	120	CYL as Ø	5709131008378	200	10
10501908	8.0	130	200	CYL as Ø	5709131008392	100	10
10501910	9.0	70	130	CYL as Ø	5709131008446	200	10
10501911	10.0	70	140	CYL as Ø	5709131008460	200	10
10501912	10.0	130	200	CYL as Ø	5709131008491	100	10
10501913	11.0	105	160	CYL as Ø	5709131008545	50	10
10501914	12.0	105	160	CYL as Ø	5709131008552	50	10
10501915	13.0	100	160	10	5709131008606	50	10
10501916	14.0	100	160	10	5709131008613	50	10

GRANITE DRILL BIT CASSETTES

ITEM NO.	DESCRIPTION	EAN	MASTER PACK	SHELF PACK
10501917	Granite 5pc set: 4/5/6/8/10mm	5709131248187	48	6
10501918	Granite 7pc set: 4/5/6/7/8/10/12mm	5709131248194	48	6
10505673	Granite 4.0 x 60 x CYL	5706915056730	1	1
10505674	Granite 3.5 x 60 x CYL	5706915056747	1	1



10501917



10501918

joran®

GLASS AND TILE BITS

FOR DRILLING GLASS, TILE AND CERAMICS

Carbide spear-point tip cuts clean, round holes with minimised chipping in glass, tile and ceramic.



ITEM NO.	DESCRIPTION	EAN	MASTER PACK	SHELF PACK
10507903	Glass & Tile 4mm	5706915079036	200	10
10507904	Glass & Tile 5mm	5706915079043	200	10
10507905	Glass & Tile 6mm	5706915079050	200	10
10507906	Glass & Tile 7mm	5706915079067	200	10
10507907	Glass & Tile 8mm	5706915079074	200	10
10507909	Glass & Tile 10mm	5706915079098	200	10

GLASS AND TILE DRILL BITS

ITEM NO.	DESCRIPTION	EAN	MASTER PACK	SHELF PACK
10507912	Glass & Tile 5 pc set: 4/5/6/8/11mm	5706915079128	120	5

GLASS & TILES

USEFUL TIPS:

1. Drill with low RPM
2. High pressure
3. No hammer action
4. Not suitable for use on toughened glass or porcelain



10507912

DIAMOND DRILL BITS

FOR FAST, SMOOTH CUTTING IN ALL GRADES OF HARD AND SOFT TILES



ITEM NO.	DESCRIPTION	EAN	MASTER PACK	SHELF PACK
10507892	Diamond Drill BIT 5mm	5706915078923	60	1
10507893	Diamond Drill BIT 6mm	5706915078930	60	1
10507894	Diamond Drill BIT 7mm	5706915078947	60	1
10507895	Diamond Drill BIT 8mm	5706915078954	60	1
10507896	Diamond Drill BIT 10mm	5706915078961	60	1
10507897	Diamond Drill BIT 12mm	5706915078978	60	1
10507898	Diamond Drill BIT 14mm	5706915078985	60	1

DIAMOND



10507896

USEFUL TIPS:

1. Drilling with water increases the lifespan of the tool.
2. Do not press strongly on the tool, let it work.
3. Make a swinging movement to allow dust evacuation.
4. Cutting speed: 2700 RPM.
5. No hammer action.



The drill needs to run before hitting the surface. To avoid sliding of the drill, start with an angle of 45°.



Once the hole has started, raise the drill gradually up to the vertical line.



Make an oscillating movement while drilling.

DIAMOND DRILL BIT SET

ITEM NO.	DESCRIPTION	EAN	MASTER PACK	SHELF PACK
10507900	Diamond 4pc set: 5/6/7/8mm	5706915079005	60	1

10507900



Masonry Drilling



MORTAR RAKES

The Mortar Rake is designed to replace traditional methods of mortar removal such as powered mortar chisels and cutting discs. The rake is faster and less intrusive to surrounding brickwork and, unlike other methods, it is just as efficient for both horizontal and vertical joint clearing.

Please note that the cutters must be used together with an adaptor (10507234) and angle grinder.



ITEM NO.	DESCRIPTION	EAN	MASTER PACK	SHELF PACK
10507229	8,0 x 20/40mm, 3 cutter, (2 pcs.)	5706915072297	50	5
10507230	10,0 x 20/40mm, 3 cutter (2 pcs.)	5706915072303	50	5
10507231	12,0 x 20/40mm, 3 cutter, (2 pcs.)	5706915072310	50	5
10507232	8,0 x 20/40mm, 4 cutter, (2 pcs.)	5706915072327	50	5
10507233	10,0 x 20/40mm, 4 cutter (2 pcs.)	5706915072334	50	5
10507234	Adaptor	5706915072341	50	5
10502880	Sole plate U500	5709131266488	15	1
10507267	Starter kit 8mm 1 pc. sole plate, 2 pcs. 8,0mm 3 cutter - 1 pc. adaptor	5706915072679	15	1
10507268	Starter kit 10mm 1 pc. sole plate 2 pcs. 10mm 3 cutter - 1 pc. adaptor	5706915072686	15	1

M-SYSTEM



HOW IT WORKS

1. Push the body backwards and start drilling.
New IRWIN® Carbide Tip Design ensures an easy start on fibre cement.
2. After drilling the hole pull back the pilot drill and fix the hexagon-screw with the same tool.
3. Special spring to keep the screw in place before fixing.
No more adapters or additional power tools required for roofing applications.
For more convenient and safer work.

ITEM NO.	DESCRIPTION	EAN	MASTER PACK	SHELF PACK
10507590	M-System 8 mm	5706915075908	30	5
10502865	M-System 11 mm	5709131054276	15	1
10503476	8 mm Drill Bit for M-System	5709131054290	200	10
10507937	11 mm Drill Bit for M-System	5706915079371	200	10

2-IN-1 TOOL DESIGN for easy and fast fixing of fibre cement and similar roofing/panelling materials
IMPROVED CARBIDE TIP ensures easy starts
SPECIAL SPRING keeps the screw in place before fixing

METAL DRILLING



ENGINEERED FOR CONTROLLED PRECISION AND SPEED

The IRWIN® line of metal drill bits offers a solution for every professional application. Each metal drill bit is made of high speed steel with high precision-cut point and spiral, ensuring durability and quality.

- TOTAL LENGTH:** The length from the point to the end of the drill bit
- POINT ANGLE:** The angle of the cutting edges
- DRILL DIAMETER:** The cutting diameter of the drill bit
- SHANK LENGTH:** The length of the drill bit that is secured by the drill
- WORKING LENGTH:** The length from the point to the end of the flutes

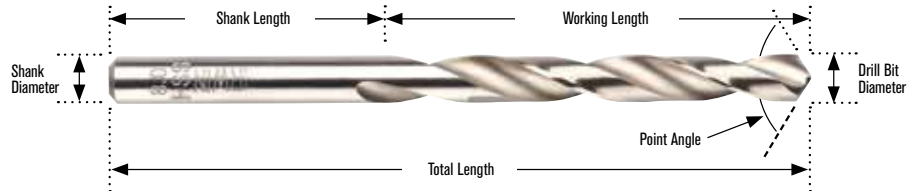

TIP GEOMETRY

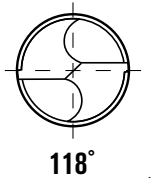

118° STANDARD POINT

- For drilling in alloyed and non-alloyed steels, non-ferrous metals, cast iron and hard plastics
- Can be easily resharpened
- Requires higher feed pressure
- Best for stationary drills

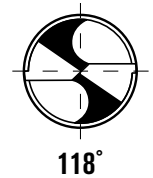

118° SPLIT POINT

- For drilling in alloyed and non-alloyed steels, non-ferrous metals, cast iron and hard plastics
- Very good centering
- Requires less effort / feed pressure

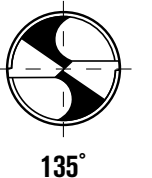

135° SPLIT POINT

- For drilling in high strength steel and high-alloy steels
- Very good centering
- Requires less effort / feed pressure

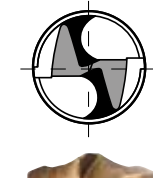

TURBOMAX® JET POINT

- Specially designed for portable drills
- Excellent centering, will not walk on any surface
- Precision-ground to stay sharp longer and drill faster



HSS DRILL BITS



HSS TURBOMAX



HSS TITANIUM



HSS COBALT



HSS PRO

SPECIALITY DRILL BITS



STEP DRILLS



TCT

TURBOMAX™ HSS

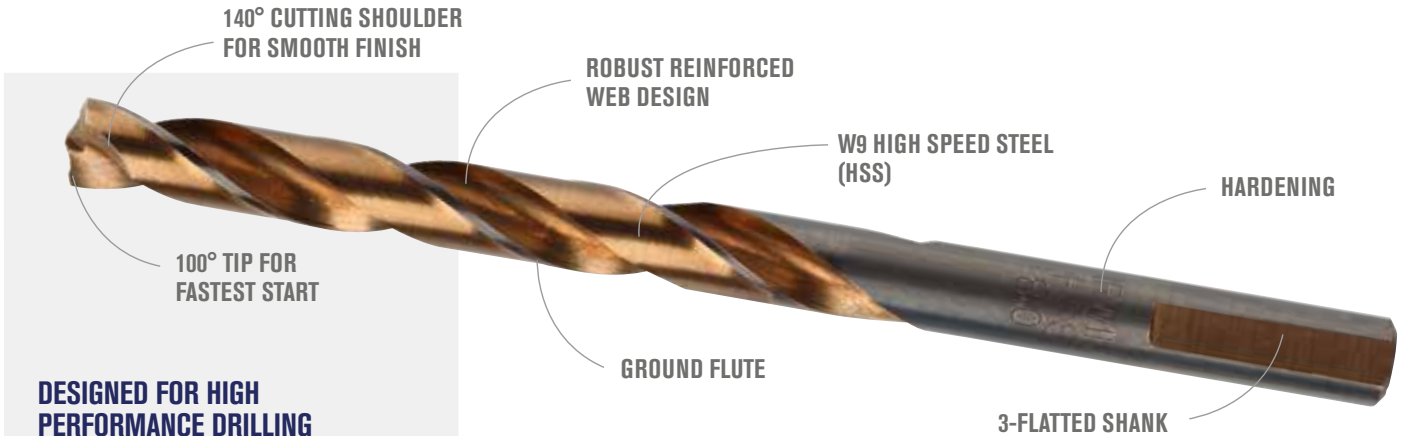

DESIGNED FOR HIGH PERFORMANCE DRILLING

Turbomax™ is designed primarily for high performance drilling in sheet metal, however, also performs well in all types of wood and plastic. Suitable for drilling stainless steel however, HSS Cobalt products (p.114) are designed specifically for this purpose. Remember to always use a coolant when drilling stainless steel.



1. 100° TIP FOR FASTEST START

Most precise centering and guidance
No walking, including curved surfaces
No centre punch necessary

2. 140° CUTTING SHOULDER FOR SMOOTH FINISH

Drills perfectly round holes with clean exit holes
- minimised burrs
Will not bind in multiple layers of thin material

3. GROUND FLUTE

Ground from solid for high accuracy drilling and fast removal of chips

4. ROBUST REINFORCED WEB DESIGN

For added strength and durability - no breakage

5. W9 HIGH SPEED STEEL (HSS)

For sharper cutting lips and superb heat resistance

6. HARDENING

Superb wear resistance. Hardness of 63-66 HRC

7. 3-FLATTED SHANK

Prevents slipping in chuck
No damaging of the drill due to slipping
Safe and strong clamping, especially when using keyless chucks



JET POINT – REVOLUTIONARY TIP DESIGN

Self centering, will not walk on any surfaces

TURBOMAX™ HSS DRILL BITS



10502225

ITEM NO.	DIAMETER mm	WORKING LENGTH mm	TOTAL LENGTH mm	PCS PER PACK	EAN	MASTER PACK	SHELF PACK
10502202	1.0	12	34	2	5709131232889	50	10
10502203	1.5	18	40	2	5709131232902	50	10
10502204	2.0	24	49	2	5709131232926	50	10
10502205	2.5	30	57	2	5709131232940	50	10
10502206	3.0	33	61	1	5709131232964	50	10
10502207	3.1	36	65	1	5709131232988	50	10
10502208	3.2	36	65	1	5709131233008	50	10
10502209	3.3	36	65	1	5709131233046	50	10
10502210	3.5	39	70	1	5709131233060	50	10
10502211	4.0	43	75	1	5709131233084	50	10
10502212	4.1	43	75	1	5709131233107	50	10
10502213	4.2	43	75	1	5709131233121	50	10
10502214	4.3	47	75	1	5709131233541	50	10
10502215	4.5	47	80	1	5709131233145	50	10
10502216	4.8	52	86	1	5709131233169	50	10
10502217	4.9	52	86	1	5709131233183	50	10
10502218	5.0	52	86	1	5709131233206	50	10
10502219	5.1	52	86	1	5709131233220	50	10
10502220	5.5	57	93	1	5709131233244	50	10
10502221	6.0	57	93	1	5709131233268	50	10
10502222	6.5	63	101	1	5709131233282	50	10
10502223	7.0	69	109	1	5709131233305	50	10
10502224	7.5	69	109	1	5709131233329	50	10
10502225	8.0	75	117	1	5709131233367	50	10
10502226	8.5	75	117	1	5709131233381	50	10
10502227	9.0	81	125	1	5709131233404	50	10
10502228	9.5	81	125	1	5709131233428	50	10
10502229	10.0	87	133	1	5709131233442	50	10
10502230	11.0	94	142	1	5709131233466	30	10
10502231	12.0	101	151	1	5709131233480	30	10
10502232	13.0	101	151	1	5709131233503	30	10

TURBOMAX™ HSS DRILL BIT SET



10502234



10502233

ITEM NO.	DESCRIPTION	EAN	MASTER PACK	SHELF PACK
10502234	HSS Turbomax, 5pc set: 4/5/6/8/10mm	5709131266167	48	6
10502233	HSS Turbomax, 19pc set in metal case: 1,0 - 10,0mm in steps of 0,5mm	5709131240693	5	5
IW3031503	HSS Turbomax, 15pc set in small case: 1.5 to 10mm	5054905247812	5	5

HSS COBALT



135° SPLIT POINT GRINDING

INDUSTRIAL QUALITY GROUND FLUTE

COBALT ALLOYED DRILL BIT BODY

GOLDEN TEMPERED SURFACE FINISH

DESIGNED FOR DRILLING STAINLESS STEEL

- 1. 135° SPLIT POINT GRINDING**
Ensures perfect centering and reduced drilling pressure
- 2. INDUSTRIAL QUALITY GROUND FLUTE**
For high accuracy drilling and fast removal of chips
- 3. COBALT ALLOYED DRILL BIT BODY**
Manufactured from high quality HSS steel containing 5% Cobalt (Co) – added 5% Cobalt improves the red hardness (heat resistance) and abrasion resistance of the drill bit and results in significantly extended life
- 4. GOLDEN TEMPERED SURFACE FINISH**
For increased durability

HSS COBALT DRILL BITS - DIN 338

ITEM NO.	DIAMETER mm	WORKING LENGTH mm	TOTAL LENGTH mm	PCS PER PACK	EAN	MASTER PACK	SHELF PACK
10502542	3.0	33	61	1	5709131282693	200	10
10502544	3.2	36	65	1	5709131282778	200	10
10502546	3.5	39	70	1	5709131282853	200	10
10502547	4.0	43	75	1	5709131282891	200	10
10502549	4.2	43	75	1	5709131282976	200	10
10502551	4.5	47	80	1	5709131283058	200	10
10502552	4.8	52	86	1	5709131283096	200	10
10502553	4.9	52	86	1	5709131283133	200	10
10502554	5.0	52	86	1	5709131283171	200	10
10502556	5.5	57	93	1	5709131283256	200	10
10502557	6.0	57	93	1	5709131283294	200	10
10502558	6.5	63	101	1	5709131283331	100	10
10502559	7.0	69	109	1	5709131283379	100	10
10502560	7.5	69	109	1	5709131283416	100	10
10502561	8.0	75	117	1	5709131283454	100	10
10502562	8.5	75	117	1	5709131283492	100	10
10502563	9.0	81	125	1	5709131283539	100	10
10502564	9.5	81	125	1	5709131283577	100	10
10502565	10.0	87	133	1	5709131283614	100	10
10502566	11.0	94	142	1	5709131283652	50	10
10502567	12.0	101	151	1	5709131283690	50	10
10502568	13.0	101	151	1	5709131283737	50	10



10502561

HSS COBALT DRILL BITS - DIN 338 - BULK PACK

ITEM NO.	DIAMETER mm	WORKING LENGTH mm	TOTAL LENGTH mm	PCS PER PACK	EAN	MASTER PACK	SHELF PACK
10502515	3.0	33	61	10	5706915000535	50	1
10502517	3.2	36	65	10	5706915000573	50	1
10502519	3.5	39	70	10	5706915000610	50	1
10502520	4.0	43	75	10	5706915000634	50	1
10502522	4.2	43	75	10	5706915000672	50	1
10502524	4.5	47	80	10	5706915000719	50	1
10502527	5.0	52	86	10	5706915000771	50	1
10502529	5.5	57	93	10	5706915000818	20	1
10502530	6.0	57	93	10	5706915000832	50	1
10502531	6.5	63	101	10	5706915000856	20	1
10502532	7.0	69	109	10	5706915000894	20	1
10502533	7.5	69	109	5	5706915000870	40	1
10502534	8.0	75	117	5	5706915000917	40	1
10502535	8.5	75	117	5	5706915000931	40	1
10502536	9.0	81	125	5	5706915000955	40	1
10502537	9.5	81	125	5	5706915000979	40	1
10502538	10.0	87	133	5	5706915000993	40	1
10502539	11.0	94	142	5	5706915001013	20	1
10502540	12.0	101	151	5	5706915001037	20	1
10502541	13.0	101	151	5	5706915001051	20	1

HSS PRO COBALT DRILL BIT SETS



10502570



10502569



10503730



IW3036501

ITEM NO.	DESCRIPTION	EAN	MASTER PACK	SHELF PACK
10502570	HSS Cobalt, 5pc set: 4/5/6/8/10mm	5709131282464	48	6
10502569	HSS Cobalt, 19pc set in metal case: 1.0 - 10.0mm in steps of 0.5mm	5709131282433	25	5
10503730	HSS Cobalt, 25pc set in metal case: 1.0 - 13.0mm in steps of 0.5mm	5706915037302	4	1
IW3031505	Mixed 14pc set in small case: 2/3/3.5/4/6/8mm HSS Cobalt, 4/5/6/8mm masonry bits, 3/4/6/8mm wood bits	5054905247829	5	5
IW3036501	HSS-E Cobalt 15 pc set in small case: 1.5 to 10mm	5054905247836	5	5

HSS TITANIUM



135° SPLIT POINT GRINDING

TITANIUM NITRIDE (TiN) COATED HIGH QUALITY STEEL BODY

LESS HEAT TiN

INDUSTRIAL GROUND FLUTE

SPEED AND FEED

FAST AND PRECISE

- 135° SPLIT POINT GRINDING**
Ensures perfect centering and reduced drilling pressure
- INDUSTRIAL GROUND FLUTE**
For high accuracy drilling and fast removal of chips
- TITANIUM NITRIDE (TiN) COATED HIGH QUALITY STEEL BODY**
Resists heat and friction, providing up to six times longer life than standard metal drill bits*
The TiN coating has a hardness of app. 80 HRC and is very resistant to wear
TiN has a low coefficient of friction. This results in less power being consumed and less heat generated during the drilling
- SPEED AND FEED**
Compared to traditional HSS Twist Drill Bits, speed can be increased by 40 -60% and feed by 10 -20% without reducing the life time of the drill bit significantly
- LESS HEAT**
TiN is also a poor conductor of heat, so the heat generated during the drilling process is diverted into the chips and coolant and less into the drill bit

*Up to 6X longer bit life than black oxide coated bits

ITEM NO.	DIAMETER mm	WORKING LENGTH mm	TOTAL LENGTH mm	PCS PER PACK	EAN	MASTER PACK	SHELF PACK
10502572	1.0	12	34	2	5709131282556	200	10
10502573	1.5	18	40	2	5709131282594	200	10
10502574	2.0	24	49	2	5709131282631	200	10
10502575	2.5	30	57	2	5709131282679	200	10
10502576	3.0	33	61	1	5709131282716	200	10
10502578	3.2	36	65	1	5709131282792	200	10
10502579	3.3	36	65	1	5709131282839	200	10
10502580	3.5	39	70	1	5709131282877	200	10
10502581	4.0	43	75	1	5709131282914	200	10
10502582	4.1	43	75	1	5709131282952	200	10
10502583	4.2	43	75	1	5709131282990	200	10
10502585	4.5	47	80	1	5709131283072	200	10
10502586	4.8	52	86	1	5709131283119	200	10
10502588	5.0	52	86	1	5709131283195	200	10
10502590	5.5	57	93	1	5709131283270	200	10
10502591	6.0	57	93	1	5709131283317	200	10
10502592	6.5	63	101	1	5709131283355	100	10
10502593	7.0	69	109	1	5709131283393	100	10
10502594	7.5	69	109	1	5709131283430	100	10
10502595	8.0	75	117	1	5709131283478	100	10
10502596	8.5	75	117	1	5709131283515	100	10
10502597	9.0	81	125	1	5709131283553	100	10
10502598	9.5	81	125	1	5709131283591	100	10
10502599	10.0	87	133	1	5709131283638	100	10
10502600	11.0	94	142	1	5709131283676	50	10
10502601	12.0	101	151	1	5709131283713	50	10
10502602	13.0	101	151	1	5709131283751	50	10



10502595



10502604



10502603

HSS TITANIUM DRILL BIT SETS

ITEM NO.	DESCRIPTION	EAN	MASTER PACK	SHELF PACK
10502604	HSS Titanium, 5pc set: 4/5/6/8/10mm	5709131282471	48	6
10502603	HSS Titanium, 19pc set in metal case: 1,0 - 10,0mm in steps of 0,5mm	5709131282440	25	5
IW3038501	HSS-Pro Titanium, 15pc set in small case: 1.5/2/2.5/3/3.5/4/4.5/5/5.5/6/6.5/7/8/9/10mm	5054905247843	5	5



IW3038501

HSS PRO

HSS PRO is an industrial quality twist drill with outstanding performance and long service life. It is designed for drilling steel and steel castings, alloyed and non-alloyed steel, cast iron, non-ferrous metals, plastics and other materials. The 118° split point shape provides an optimum centering when starting and a faster drilling rate. It requires lower feed pressure than standard HSS drill bits with a chisel edge.

118° SPLIT POINT GRINDING

HIGHLY ACCURATE

GREATEST TOUGHNESS

OPTIMUM DRILLING PERFORMANCE

HIGHEST STEEL GRADE

TOUGHNESS AND PRECISION FOR PROFESSIONAL USERS
Designed for drilling a wide selection of materials

- 1. 118° SPLIT POINT SHAPE**
With increased performance and very good centering
Precision starting, no need to pre-punch or pilot drill
Penetrates quickly
Requires less effort / feed pressure
- 2. GREATEST TOUGHNESS**
For low risk of breakage even when drilling with smaller diameters due to high elasticity
- 3. OPTIMUM DRILLING PERFORMANCE**
Even in unfavourable working conditions
- 4. HIGHLY ACCURATE**
Close tolerances and high concentricity for maximum precision
- 5. HIGHEST STEEL GRADE**
High-performance, High-Speed Steel

40% MORE HOLES*
*vs previous version

HSS PRO DRILL RANGE

The HSS PRO drill bits are available for a wide array of applications: DIN 338 jobber series, DIN 340 long series, double-ended stub series, DIN 345 Morse taper shank series.

DIN 338		DIN 338 series is suitable for many trade and industrial applications in alloyed and un-alloyed steel, non-ferrous metals, cast iron and plastics.
DIN 340		DIN 340 long series is most suitable for drilling deep holes or through hollow profiles.
Double-Ended		Double-ended series is especially designed for drilling thin materials like sheet metal, flat steel and profiles. Ideal for use with hand-held drills.

HSS PRO DRILL BITS - DIN 338



ITEM NO.	DIAMETER mm	WORKING LENGTH mm	TOTAL LENGTH mm	PCS PER PACK	EAN	MASTER PACK	SHELF PACK
10502376	1.0	12	34	3	5709131104674	200	10
10502377	1.5	18	40	3	5709131104865	200	10
10502378	2.0	24	49	3	5709131105084	200	10
10502379	2.5	30	57	3	5709131105251	200	10
10502380	3.0	33	61	3	5709131105466	200	10
10502381	3.2	36	65	2	5709131105589	200	10
10502382	3.3	36	65	2	5709131105657	200	10
10502383	3.5	39	70	2	5709131105732	200	10
10502384	4.0	43	75	2	5709131105930	200	10
1863343	4.1	43	75	2	5706918633433	200	10
10502385	4.2	43	75	2	5709131106050	200	10
10502386	4.5	47	80	2	5709131106166	200	10
1863344	4.8	52	86	2	5706918633440	200	10
10502387	5.0	52	86	2	5709131106371	200	10
1863345	5.1	52	86	1	5706918633457	200	10
1863346	5.2	52	86	1	5706918633464	200	10
10502388	5.5	57	93	1	5709131106555	200	10
10502389	6.0	57	93	1	5709131106753	200	10
10502390	6.5	63	101	1	5709131106944	200	10
10502391	7.0	69	109	1	5709131107101	100	10
10502392	7.5	69	109	1	5709131107279	100	10
10502393	8.0	75	117	1	5709131107477	100	10
10502394	8.5	75	117	1	5709131107668	100	10
10502395	9.0	81	125	1	5709131107842	100	10
10502396	9.5	81	125	1	5709131108016	100	10
10502397	10.0	87	133	1	5709131108207	100	10

MANUFACTURED TO DIN 338 STANDARDS ideal for many trade and industrial applications

118° SPLIT POINT SHAPE for increased performance and very good centering

SURFACE FINISH Polished silver

PACKAGED in skin card up to Ø 13 mm, in Quadro Pack from Ø 13.5 mm and above



10502393



10502499



10502504



10502500

HSS PRO DRILL BITS - REDUCED SHANK - DIN 338



ITEM NO.	DIAMETER mm	WORKING LENGTH mm	TOTAL LENGTH mm	PCS PER PACK	EAN	MASTER PACK	SHELF PACK
10502399	11.0	94	142	10mm	5709131108597	50	10
10502401	12.0	101	151	10mm	5709131108948	50	10
10502402	12.5	101	151	10mm	5709131109099	50	10
10502403	13.0	101	151	10mm	5709131109266	50	10
10502404	13.5	108	160	10mm	5709131109402	50	10
10502405	14.0	108	160	10mm	5709131109471	50	10
10502406	14.5	114	169	10mm	5709131109570	25	5
10502407	15.0	114	169	10mm	5709131109662	25	5
10502408	15.5	120	178	10mm	5709131109730	25	5
10502409	16.0	120	178	10mm	5709131109822	25	5
10502410	16.5	125	184	13mm	5709131109921	25	5
10502411	17.0	125	184	13mm	5709131109990	25	5
10502412	17.5	130	191	13mm	5709131110064	25	5
10502413	18.0	130	191	13mm	5709131110132	25	5
10502414	18.5	135	198	13mm	5709131110200	25	5
10502415	19.0	135	198	13mm	5709131110286	25	5
10502417	20.0	140	205	13mm	5709131110439	25	5

HSS PRO DRILL BIT SETS

ITEM NO.	DESCRIPTION	EAN	MASTER PACK	SHELF PACK
10502499	HSS Pro, 5pc set: 4/5/6/8/10mm	5709131282457	48	6
10502500	HSS Pro, 19pc set in metal case: 1.0 - 10.0mm in steps of 0.5mm	5709131284628	20	5
10502504	HSS Pro, 25pc set in metal case: 1.0 - 13.0mm in steps of 0.5mm	5709131284659	16	4
IW3031501	HSS Pro, 15pc set: 1.5/2/2.5/3/3.5/4/4.5/5/5.5/6/6.5/7/8/9/10mm	5054905247805	5	5



IW3031501



10502311

HSS PRO DRILL BITS - DIN 338 - BULK PACK

ITEM NO.	DIAMETER mm	WORKING LENGTH mm	TOTAL LENGTH mm	PCS PER PACK	EAN	MASTER PACK	SHELF PACK
10502236	0.5	6	22	10	5709131035923	50	1
10502241	1.0	12	34	10	5709131036043	50	1
10502246	1.5	18	40	10	5709131036210	50	1
10502251	2.0	24	49	10	5709131036401	50	1
10502256	2.5	30	57	10	5709131036562	50	1
10502261	3.0	33	61	10	5709131036746	50	1
10502266	3.5	39	70	10	5709131036968	50	1
10502271	4.0	43	75	10	5709131231202	50	1
10502273	4.2	43	75	10	5709131037231	50	1
10502276	4.5	47	80	10	5709131037316	50	1
10502279	4.8	52	86	10	5709131037439	50	1
10502281	5.0	52	86	10	5709131037491	50	1
10502283	5.2	52	86	10	5709131037606	50	1
10502286	5.5	57	93	10	5709131037668	50	1
10502291	6.0	57	93	10	5709131037835	50	1
10502296	6.5	63	101	10	5709131038016	20	1
10502301	7.0	69	109	10	5709131038153	20	1
10502306	7.5	69	109	5	5709131038306	40	1
10502311	8.0	75	117	5	5709131038474	40	1
10502316	8.5	75	117	5	5709131038658	40	1
10502321	9.0	81	125	5	5709131038818	40	1
10502326	9.5	81	125	5	5709131038962	40	1
10502331	10.0	87	133	5	5709131039129	40	1
10502336	10.5	87	133	5	5709131039297	20	1
10502341	11.0	94	142	5	5709131039433	20	1
10502346	11.5	94	142	5	5709131039587	20	1
10502351	12.0	101	151	5	5709131039723	20	1
10502356	12.5	101	151	5	5709131039877	20	1
10502361	13.0	101	151	5	5709131040002	20	1
10502363	14.0	108	160	1	5709131040163	25	1
10502365	15.0	114	169	1	5709131040262	25	1
10502367	16.0	120	178	1	5709131040354	25	1
10502371	18.0	130	191	1	5709131040545	25	1
10502375	20.0	140	205	1	5709131040712	25	1



10502503

HSS MIXED DRILL BIT SETS

ITEM NO.	DESCRIPTION	EAN	MASTER PACK	SHELF PACK
10502503	HSS Suitcase 1.0-10.0/5.0mm	5709131264668	5	1
IW3031505	Mixed 14pc set in small case: 2/3/3.5/4/6/8mm HSS Cobalt, 4/5/6/8mm masonry bits, 3/4/6/8mm wood bits	5054905247829	5	5



HSS PRO LONG DRILL BITS - DIN 340

ITEM NO.	DIAMETER mm	WORKING LENGTH mm	TOTAL LENGTH mm	PCS PER PACK	EAN	MASTER PACK	SHELF PACK
1863347	3.0	70	110	1	5706918633471	200	10
1863348	4.0	80	120	1	5706918633488	200	10
1863349	5.0	90	135	1	5706918633495	200	10
1863350	6.0	95	140	1	5706918633501	200	10
1863361	8.0	105	160	1	5706918633617	100	10
1863362	10.0	115	175	1	5706918633624	100	10

MANUFACTURED TO DIN 340 STANDARDS for drilling deep holes or through hollow profiles
118° SPLIT POINT SHAPE for increased performance and very good centering
SURFACE FINISH is polished silver
PACKAGED in skin card

HSS PRO LONG DRILL BITS - DIN 340 - BULK PACK

ITEM NO.	DIAMETER mm	WORKING LENGTH mm	TOTAL LENGTH mm	PCS PER PACK	EAN	MASTER PACK	SHELF PACK
10502482	2.0	55	85	10	5709131061755	20	1
10502483	2.5	65	100	10	5709131041931	20	1
10502484	3.0	70	110	10	5709131041948	20	1
10503855	3.2	70	110	10	5706915938555	20	1
10502485	3.5	80	120	10	5709131041955	20	1
10502486	4.0	80	120	10	5709131041962	20	1
10503856	4.2	80	120	10	5706915938562	20	1
10502487	4.5	85	130	10	5709131041986	20	1
10502488	5.0	90	135	10	5709131041993	20	1
10502489	5.5	95	140	10	5709131042013	20	1
10502490	6.0	95	140	10	5709131042020	20	1
10502491	6.5	100	150	10	5709131111856	20	1
10502492	7.0	100	150	10	5709131042037	20	1
10502494	8.0	105	160	5	5709131042044	20	1
10502496	9.0	110	170	5	5709131061786	20	1
10502498	10.0	115	175	5	5709131042051	20	1
10503858	12.0	134	205	5	5706915938586	20	1

HSS PRO DOUBLE-ENDED DRILL BITS - BULK PACK



ITEM NO.	DIAMETER mm	WORKING LENGTH mm	TOTAL LENGTH mm	PCS PER PACK	EAN	MASTER PACK	SHELF PACK
1868262	3.0	11	46	10	5706918682622	50	1
10502479	3.3	12	49	10	5709131041559	50	1
1868266	4.0	14	56	10	5706918682660	50	1
10502480	4.1	14	56	10	5709131041634	50	1
1868267	4.2	14	56	10	5706918682677	50	1
10502481	4.9	12	56	10	5709131041702	50	1

118° SPLIT POINT SHAPE for increased performance and very good centering
PARTICULARLY SUITED for drilling thin materials, especially for car body work and tubular rivet holes
DOUBLE LIFETIME versus a single end drill bit
ADAPTED DIAMETERS for most common blind rivets
SURFACE FINISH is polished silver
PACKAGED in Quadro Pack



STEP DRILLS

DESIGNED FOR PRECISE DRILLING IN THIN MATERIALS

- SELF-CENTERING POINT**
- DOUBLE-GROUND SINGLE-FLUTE CUTTING EDGE**
- CHROME-VANADIUM STEEL**
- LASER ETCHED SIZES**
- IDEAL FOR DRILLING HOLES IN THIN MATERIALS**
- FLATTED SHANK**

- 1. SELF CENTERING POINT**
Will not walk and eliminates the need for centre punching.
- 2. CHROME-VANADIUM STEEL**
Drill bit body is hardened to 56 HRC for durability.
- 3. DOUBLE-GROUND SINGLE-FLUTE CUTTING EDGE**
For extra chip capacity, drilling of true, round holes and provides maximum step control.
- 4. IDEAL FOR DRILLING HOLES IN THIN MATERIALS**
Including mild steel, copper, brass, aluminium, plexiglass, plastic, wood and laminates.
- 5. FLATTED SHANK**
Prevents the drill bit from slipping in the chuck.
- 6. LASER ETCHED SIZES**
Inside flute for easy and permanent hole size identification.



10502850



10502853



10502855



10502852



10502854



10502856

ITEM NO.	DESCRIPTION	EAN	MASTER PACK	SHELF PACK
10502850	1M 9 Hole sizes (4mm - 12mm), 1mm increments	0038548111018	5	1
10502852	3M 7 Hole sizes (6mm - 18mm), 2mm increments	0038548111032	5	1
10502853	4M 10 Hole sizes (4mm - 22mm), 2mm increments	0038548111049	5	1
10502854	5M 13 Hole sizes (5mm - 35mm), 2 - 3mm increments	0038548111056	5	1
10502855	PG29M10 Hole sizes 5, 7.5, 10, 12.5, 15.2, 18.6, 20.4, 22.5, 25.5, 28.3mm	0038548111940	5	1
10502856	29MM 10 Hole sizes 5, 7.5, 10, 13, 16, 19, 21, 23, 26, 29mm	0038548111957	5	1
10502857	ISO/PG13 Hole sizes 5, 7.5, 9.7, 12.7, 15.2, 16.2, 18.6, 20.4, 22.5, 25.4, 28.3, 30.5, 32.5mm	0038548111967	5	1

TCT DRILL BITS

Designed for drilling hard and abrasive materials



HSS PRO DRILL BITS - DIN 338

ITEM NO.	DIAMETER mm	WORKING LENGTH mm	TOTAL LENGTH mm	EAN	MASTER PACK	SHELF PACK
10502618	2.0	24	51	5709131042235	50	10
10502619	2.5	30	57	5709131042372	50	10
10502620	3.0	33	61	5709131042549	50	10
10502622	3.2	39	70	5709131042617	50	10
10502626	3.5	39	70	5709131042723	50	10
10502631	4.0	43	75	5709131042907	50	10
10502636	4.5	47	80	5709131043089	50	10
10502641	5.0	52	86	5709131043270	50	10
10502646	5.5	57	93	5709131043461	50	10
10502651	6.0	57	93	5709131043645	50	10
10502656	6.5	63	101	5709131043829	50	10
10502661	7.0	69	109	5709131043980	50	10
10502666	7.5	69	109	5709131044147	50	10
10502671	8.0	75	117	5709131044307	50	10
10502676	8.5	75	117	5709131044475	50	10
10502680	9.0	81	125	5709131044659	50	10
10502685	9.5	81	125	5709131044772	50	10
10502689	10.0	87	133	5709131044949	50	10
10502690	10.5	87	133	5709131045137	30	10
10502691	11.0	94	142	5709131045274	30	10
10502693	12.0	101	151	5709131045564	30	10
10502695	13.0	101	151	5709131045847	30	10
10502697	14.0	108	160	5709131045922	30	10
10502699	15.0	114	169	5709131045991	15	10
10502701	16.0	120	178	5709131046097	15	5

FOUR FACETED GROUND CARBIDE TIP for low drilling pressure and perfect centering
EXTRA DEEP GROUND DOUBLE FLUTES for extra chip capacity
REDUCED FLUTE for body clearance and less friction
CHROME-VANADIUM STEEL BODY is hardened to 56 HRC for durability.
ALWAYS USE COOLANT when drilling with TCT Twist Drill Bits to extend the life time of the drill bit. It is recommended to use a 3-6% emulsion.



10502671



SPEEDBOR™

IRWIN®

In 1885, Charles Irwin patented the Auger bit and, along with four business partners, formed the IRWIN® Auger Bit Company in Ohio, USA. Over 125 years later, IRWIN® is still the leading manufacturer of wood drilling bits and accessories. No matter what wood drilling project you face, IRWIN® Tools makes a drill bit that performs the job better. Our mark of quality is stamped right on the shank of our full range of bits. Whether the job requires quick, clean holes, or precise finish work, IRWIN® has a bit for every application and every need.

Professionals can now improve their productivity and accuracy with IRWIN® innovative ranges. IRWIN® Blue Groove 4X and Blue Groove 6X wood boring bits raise-the-bar on tool quality and performance. The cutting edge technology incorporates true “cutting edges” that glide through the wood versus scraping its way through. The latest generation Blue Groove Power is adding extreme durability thanks to Bi-Metal Technology.



TRI-FLUTE & FLAT BITS



BLUE GROOVE POWER



BLUE GROOVE 6X



BLUE GROOVE 4X

TRADITIONAL BITS



AUGER



BRAD POINT

EXTENSIONS



QUICK-CHANGE EXTENSIONS



STANDARD EXTENSIONS



BLUE GROOVE POWER WOOD BORING BITS



FULL SCREW TIP

COMPACT LENGTH

TAPERED TRI-FLUTE DESIGN

EXTREME DURABILITY

QUICK-CHANGE SHANK

TOUGHER THAN NAILS

THE LONGEST LASTING WOOD BORING BIT

- EXTREME DURABILITY**
HSS tip manufactured with Bi-Metal technology cutting edges provide long life in tough applications including nail-embedded wood
- FULL SCREW TIP**
For easy pull through and added accuracy
- TAPERED TRI-FLUTE DESIGN**
For faster chip ejection, less binding and ease of use
- COMPACT LENGTH**
Designed to fit between studs in most common applications
- QUICK-CHANGE SHANK**
1/4" Quick-Change shank on 14-16mm bits and 3/8" Quick-Change shank on 18-32mm bits

6X

*Up to 6 times faster vs. IRWIN® SPEEDBOR™ Classic flat bits

x50 LIFE

* 50 times life versus Blue Groove 6X in nail embedded wood

Quick Change Shank

Nail-Embedded Wood

LONG-LASTING



10507713



10507720

10507764

ITEM NO.	DESCRIPTION	EAN	MASTER PACK	SHELF PACK
10507712	BlueGroove Power 14mm	5706915077124	36	1
10507713	BlueGroove Power 16mm	5706915077131	36	1
10507714	BlueGroove Power 18mm	5706915077148	36	1
10507715	BlueGroove Power 20mm	5706915077155	36	1
10507716	BlueGroove Power 22mm	5706915077162	36	1
10507717	BlueGroove Power 25mm	5706915077179	36	1
10507718	BlueGroove Power 28mm	5706915077186	36	1
10507719	BlueGroove Power 32mm	5706915077193	36	1

BLUE GROOVE POWER WOOD BORING BIT SETS

ITEM NO.	DESCRIPTION	EAN	MASTER PACK	SHELF PACK
10507720	Blue Groove Power, 3pc set: 14/16/18mm	5706915077209	36	1
10507764	Blue Groove Power, 3pc set: 20/22/25mm	5706915077643	36	1

MIXED BLUE GROOVE POWER AND BLUE GROOVE 6X WOOD BORING BITS SETS

ITEM NO.	DESCRIPTION	EAN	MASTER PACK	SHELF PACK
10507593	Mixed 8pc set	5706915075939	6	1

SPEEDBOR™

BLUE GROOVE 6X WOOD BORING BITS

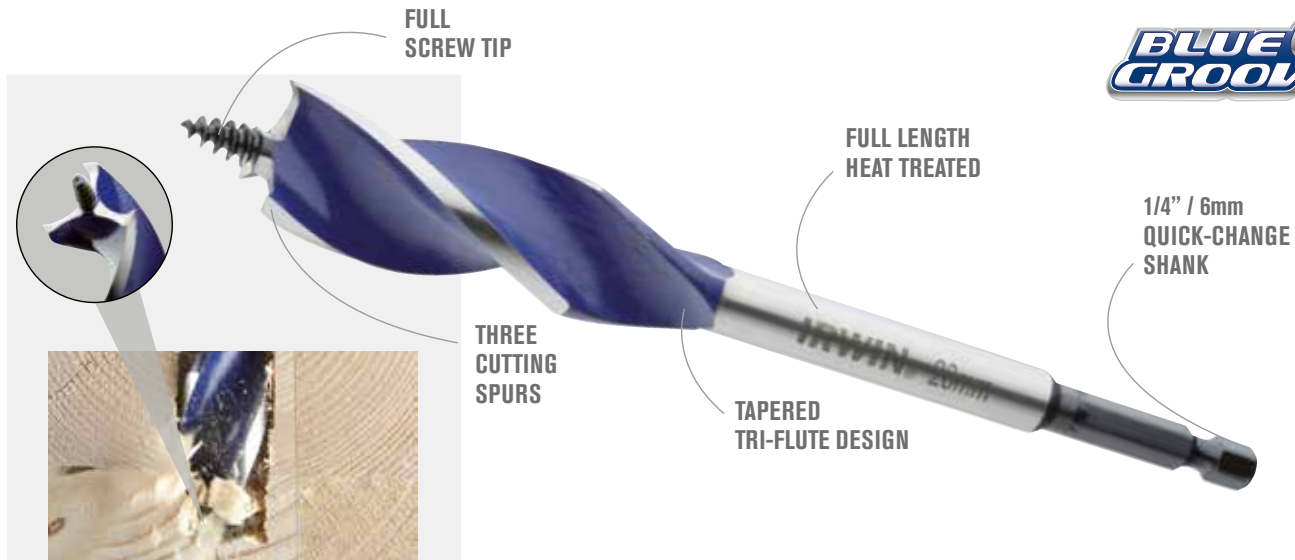

6 TIMES FASTER THAN SPEEDBOR™ CLASSIC FLAT BITS



*Up to 6 times faster vs. IRWIN® SPEEDBOR™ Classic flat bits



Quick Change Shank



Saves Battery Life



Wood

1. THREE CUTTING SPURS

For clean holes with minimal break out

2. FULL SCREW TIP

For easy pull through and added accuracy

3. TAPERED TRI-FLUTE DESIGN

For faster chip ejection, less binding and ease of use

4. FULL LENGTH HEAT TREATED

For extra durability

5. 1/4" / 6mm QUICK-CHANGE SHANK

Reduces slipping in standard chucks and is compatible with 1/4" / 6mm quick-change chucks

6. MULTIPLE LENGTHS AVAILABLE - 4", 6" & 16"

Short Length Bits for for drilling in tight spaces. Ideal for holes up to 2" (50mm) deep
Standard length bits ideal for holes up to 4" (100mm) deep
Extended length bits include hole in flute for easy wire pulling through walls, ceilings and floors

ITEM NO.	DESCRIPTION	EAN	MASTER PACK	SHELF PACK
SHORT LENGTH BITS - 4" / 100mm				
1921930	Blue Groove 6X 14mm x 4"	5706919219308	36	3
1921991	Blue Groove 6X 16mm x 4"	5706919219919	36	3
1921992	Blue Groove 6X 18mm x 4"	5706919219926	36	3
1921993	Blue Groove 6X 20mm x 4"	5706919219933	36	3
1921994	Blue Groove 6X 22mm x 4"	5706919219940	36	3
1921995	Blue Groove 6X 25mm x 4"	5706919219957	36	3
1921996	Blue Groove 6X 28mm x 4"	5706919219964	36	3
1921997	Blue Groove 6X 32mm x 4"	5706919219971	36	3
STANDARD LENGTH BITS - 6" / 152mm				
10507602	Blue Groove 6X 14mm x 6"	5706915076028	36	6
10506620	Blue Groove 6X 16mm x 6"	5706915066203	36	6
10506621	Blue Groove 6X 18mm x 6"	5706915066210	36	6
10506622	Blue Groove 6X 20mm x 6"	5706915066227	36	6
10506623	Blue Groove 6X 22mm x 6"	5706915066234	36	6
10506624	Blue Groove 6X 25mm x 6"	5706915066241	36	6
10506625	Blue Groove 6X 28mm x 6"	5706915066258	36	6
10506626	Blue Groove 6X 32mm x 6"	5706915066265	36	6
EXTENDED LENGTH BITS - 16" / 400mm				
1921998	Blue Groove 6X 14mm x 16"	5706919219988	36	3
1921999	Blue Groove 6X 16mm x 16"	5706919219995	36	3
1922000	Blue Groove 6X 18mm x 16"	5706919220007	36	3
1922001	Blue Groove 6X 20mm x 16"	5706919220014	36	3
1922002	Blue Groove 6X 22mm x 16"	5706919220021	36	3
1922003	Blue Groove 6X 25mm x 16"	5706919220038	36	3
1922004	Blue Groove 6X 28mm x 16"	5706919220045	36	3
1922005	Blue Groove 6X 32mm x 16"	5706919220052	36	3



Wood Drilling



10506627

BLUE GROOVE 6X WOOD BORING BIT SETS

ITEM NO.	DESCRIPTION	EAN	MASTER PACK	SHELF PACK
10506627	Blue Groove 6X, 3pc set: 20/22/25mm	5706915066272	6	1
1922006	Blue Groove 6X, 3pc clam set: 16/20/25mm	5706919220069	36	3
1922007	Blue Groove 6X, 5pc clam set: 16/18/20/22/25mm + extension	5706919220076	1	1

BLUE GROOVE 4X FLAT BITS

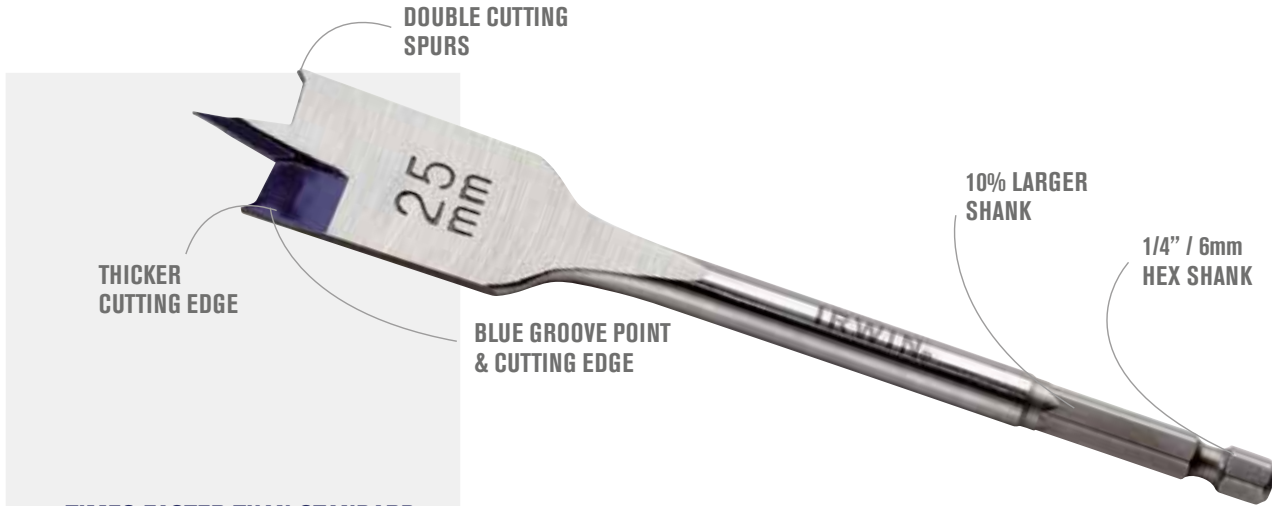

4 TIMES FASTER THAN STANDARD FLAT BITS



- 1. DOUBLE CUTTING SPURS**
Scribe outside of the hole, reducing breakout
- 2. THICKER CUTTING EDGE**
For longer drilling life
- 3. BLUE GROOVE POINT & CUTTING EDGE**
For faster chip removal
- 4. 10% LARGER SHANK**
For added durability
- 5. 1/4" / 6mm HEX SHANK**
Prevents bit slipping in chuck

BLUE GROOVE 4X FLAT BITS - LENGTH 152mm

ITEM NO.	DESCRIPTION	EAN	MASTER PACK	SHELF PACK
10502803	6mm	0024721013811	36	6
10502804	8mm	0024721013828	36	6
10502805	10mm	0024721013835	36	6
10502806	12mm	0024721013842	36	6
10502807	13mm	0024721013859	36	6
10502808	14mm	0024721013866	36	6
10502809	16mm	0024721013873	36	6
10502810	17mm	0024721889171	36	6
10502811	18mm	0024721013880	36	6
10502812	19mm	0024721013897	36	6
10502813	20mm	0024721013903	36	6
10502814	22mm	0024721013910	36	6
10502815	24mm	0024721013934	36	6
10502816	25mm	0024721013941	36	6
10502817	26mm	0024721013958	36	6
10502818	28mm	0024721013965	36	3
10502819	30mm	0024721013972	36	3
10502820	32mm	0024721013989	36	3
10502821	35mm	0024721014009	36	3
10502822	38mm	0024721014016	36	3
10502823	40mm	0024721889409	36	3

ITEM NO.	DESCRIPTION	EAN	MASTER PACK	SHELF PACK
IW4041002	Blue Groove 4X 17pc set: 6/8/10/12/13/14/16/18/19/20/22/24/25/28/32/35/38mm	5054905255213	5	5
IW4041003	Blue Groove 3pc set: 16/20/25mm	5054905255480	6	6
IW4041010	Medium Storage Case Blue Groove 4X 8pc set: 12/16/18/20/22/25/28/32mm	5054905247850	5	5
IW4041011	Medium Storage Case Blue Groove 4X 8pc set: 12/14/16/18/20/22/25/32mm	5054905247867	5	5
IW4042202	Medium Storage Case Blue Groove 6X 6pc set: 16/18/20/22/25/32mm	5054905247874	5	5



10502813



IW4041011

SPEEDBOR™

BLUE GROOVE 4X FLAT BITS - LENGTH 400mm



LONGER LENGTH for extended reach
NOT FOR USE with bit extensions or drill presses

ITEM NO.	DESCRIPTION	EAN	MASTER PACK	SHELF PACK
10502830	6mm	0024721886064	36	6
10502831	8mm	0024721886088	36	6
10502832	10mm	0024721013064	36	6
10502833	12mm	0024721014153	36	6
10502834	13mm	0024721014184	36	6
10502835	14mm	0024721013071	36	6
10502836	16mm	0024721014191	36	6
10502837	18mm	0024721014207	36	6
10502838	19mm	0024721013088	36	6
10502839	20mm	0024721014214	36	6
10502840	22mm	0024721014221	36	6
10502842	25mm	0024721014245	36	6
10502843	28mm	0024721014269	18	3
10502844	30mm	0024721014276	18	3
10502845	32mm	0024721014283	18	3
10502846	35mm	0024721014290	18	3

BLUE GROOVE 4X FLAT DRILL BIT SETS



10502826

ITEM NO.	DESCRIPTION	EAN	MASTER PACK	SHELF PACK
10502826	Blue Groove 4X, 6pc set: 10/13/16/19/22/25mm	24721253149	6	1

BRAD POINT



SOLID CENTRE AUGER WITH CUTTING SPUR



BRAD POINT TIP provides accurate positioning for starting the hole

BIT IS PRECISION GROUND for use in furniture making, doweling, cabinetry and other woodworking applications where an exact hole size is required

SPUR CUTTING EDGES reduce splintering and ensure a smooth, clean hole

WIDE FLUTES provide a fast, continuous flow of chips

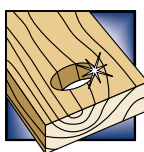

Perfect for all types of wood
Creates perfect and straight holes

ITEM NO.	DIAMETER mm	WORKING LENGTH mm	TOTAL LENGTH mm	EAN	MASTER PACK	SHELF PACK
10502792	3.0	37	67	5709131134534	200	10
10502793	4.0	52	88	5709131134558	200	10
10502794	5.0	59	95	5709131134572	200	10
10502795	6.0	67	103	5709131134596	200	10
10502796	8.0	78	119	5709131134619	200	10
10502797	10.0	87	136	5709131134633	200	10
10502798	12.0	100	145	5709131134657	100	10
10502799	13.0	104	149	5709131134671	100	10
10502800	16.0	130	178	5709131134695	25	5

MIXED DRILL BIT SET











ITEM NO.	DESCRIPTION	EAN	MASTER PACK	SHELF PACK
IW3031505	Mixed 14pc set in small storage case: : 2/3/3.5/4/6/8mm HSS Cobalt, 4/5/6/8mm masonry bits, 3/4/6/8mm wood bits	5054905247829	5	5

LOCK-N-LOAD™ QUICK-CHANGE EXTENSIONS

6 TIMES FASTER THAN STANDARD FLAT BITS









LOCK-N-LOAD™ COMPATIBILITY

6,3 mm (1/4")	
	ALL POWER BITS
	ALL INSERT BITS
	 ALL BLUE GROOVE 4X
	 ALL BLUE GROOVE 6X
	 BLUE GROOVE POWER 14 - 16mm
	 STEP DRILLS 1M - 2M

LOCK-N-LOAD™ SYSTEM for one-handed quick release
JAW DESIGN holds bits securely on 6-flatted shanks, as well as ball detent bits
1/4" QUICK CHANGE RANGE now holds insert bits
CARBON STEEL CONSTRUCTION SLEEVE AND BODY for durability and life
LOCK-N-LOAD™ COMPATIBILITY



9,5 mm (3/8")	
	 STEP DRILLS (SIZE 3M - 4M)
	 HOLE SAW ARBORS 9.5mm
	 BLUE GROOVE POWER 18 - 32mm

ITEM NO.	DESCRIPTION	EAN	MASTER PACK	SHelf PACK
10508166	1/4" Quick Change Bit Holder - 2,5" / 65 mm	5706915081664	48	6
10508167	1/4" Quick Change Bit Holder - 6" / 150 mm	5706915081671	48	6
10508168	1/4" Quick Change Bit Holder - 12" / 300 mm	5706915081688	48	6
10508170	3/8" Quick Change Bit Holder - 5,5" / 140 mm	5706915081701	24	3
10508171	3/8" Quick Change Bit Holder - 12" / 300 mm	5706915081718	24	3
10502824	Blue Groove Ext 12"/300 mm	0024721056016	48	6
10502825	Blue Groove Ext 6"/150 mm	0024721056009	48	6



10508167



AUGER

SOLID CENTRE AUGER WITH CUTTING SPUR



The Original
AUGER

AUGER DRILL BITS

- COARSE SCREW POINT** for faster drilling into all types of wood
- SINGLE SPUR DESIGN** for smoother hole finish
- EXTRA WIDE FLUTE** for faster chip removal
- FULLY HARDENED BODY** from tip to shank for extra durability
- HEX SHANK** prevents bit slipping in chuck

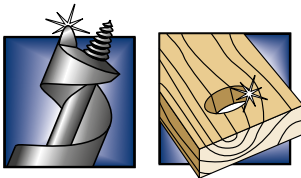

Perfect for all types of wood
Creates perfect and straight holes



10502761

ITEM NO.	DIAMETER mm	WORKING LENGTH mm	TOTAL LENGTH mm	HEX FACES mm	HEX FACES Inches	EAN	MASTER PACK	SHELF PACK
10502738	5.0	73	150	3.9	5/32	5709131135579	24	1
10502739	6.0	114	191	4.8	3/16	5709131133490	24	1
10502740	6.0	323	400	4.8	3/16	5709131133957	24	1
10502741	8.0	114	191	5.6	7/32	5709131133513	24	1
10502742	8.0	323	400	5.6	7/32	5709131133971	24	1
10502744	10.0	114	191	7.9	5/16	5709131133537	24	1
10502745	10.0	323	400	7.9	5/16	5709131133995	24	1
10502747	11.0	114	191	7.9	5/16	5709131133551	24	1
10502748	12.0	114	191	7.9	5/16	5709131133575	24	1
10502749	12.0	323	400	7.9	5/16	5709131134015	24	1
10502751	13.0	114	191	7.9	5/16	5709131133599	24	1
10502752	13.0	323	400	7.9	5/16	5709131134039	24	1
10502754	14.0	126	191	7.9	5/16	5709131133612	24	1
10502755	14.0	335	400	7.9	5/16	5709131134053	24	1
10502756	15.0	126	191	7.9	5/16	5709131133636	24	1
10502757	16.0	126	191	7.9	5/16	5709131133650	24	1
10502758	16.0	335	400	7.9	5/16	5709131134077	24	1
10502760	17.0	126	191	7.9	5/16	5709131133674	24	1
10502761	18.0	126	191	7.9	5/16	5709131133698	24	1
10502762	18.0	335	400	7.9	5/16	5709131134091	24	1
10502764	19.0	126	191	7.9	5/16	5709131133711	24	1
10502765	19.0	335	400	7.9	5/16	5709131134114	24	1
10502766	20.0	126	191	7.9	5/16	5709131133735	24	1
10502767	20.0	335	400	7.9	5/16	5709131134138	24	1
10502769	22.0	126	191	7.9	5/16	5709131133759	24	1
10502770	22.0	335	400	7.9	5/16	5709131134152	24	1
10502772	24.0	126	191	7.9	5/16	5709131133773	24	1
10502773	24.0	335	400	7.9	5/16	5709131134176	24	1
10502774	25.0	126	191	7.9	5/16	5709131133797	24	1
10502775	25.0	335	400	7.9	5/16	5709131134190	24	1
10502776	26.0	126	191	11.1	7/16	5709131133810	24	1
10502777	26.0	335	400	11.1	7/16	5709131134213	24	1
10502778	28.0	175	240	11.1	7/16	5709131133834	24	1
10502779	28.0	335	400	11.1	7/16	5709131134237	24	1
10502780	30.0	175	240	11.1	7/16	5709131133858	24	1
10502781	30.0	335	400	11.1	7/16	5709131134251	16	1
10502782	32.0	175	240	11.1	7/16	5709131133872	24	1
10502783	32.0	335	400	11.1	7/16	5709131134275	16	1
10502784	35.0	175	240	11.1	7/16	5709131133896	24	1
10502785	35.0	335	400	11.1	7/16	5709131134312	16	1
10502786	36.0	335	400	11.1	7/16	5709131134336	16	1
10502787	38.0	175	240	11.1	7/16	5709131133919	24	1
10502788	40.0	175	240	11.1	7/16	5709131133933	24	1

AUGER DRILL BIT EXTENSIONS



10502790

ITEM NO.	DESCRIPTION	EAN	MASTER PACK	SHELF PACK
10502789	5/16" / 7,9mm Extension 450mm for Auger Ø10 - 25mm	5709131134756	25	5
10502790	7/16" / 11,1mm Extension 450mm for Auger Ø26 - 40mm	5709131134756	25	5

FASTENER DRIVES & SCREWDRIVING



IRWIN® IMPACT PRO PERFORMANCE SERIES™

DRILLING BITS AND ACCESSORIES DESIGNED FOR IMPACT DRIVERS.

Designed for trade professionals who expect the highest performance, power and durability from their tools and accessories, IRWIN® has launched the IMPACT PRO PERFORMANCE SERIES: a new line-up of innovative, high-strength, magnetised* Impact Bits. Engineered for use with the most powerful impact drivers and drills for the completion of multiple metal and wood fastening applications, these robust and reliable impact bits can handle the most powerful turning force and torque requirements.



- 1. FULL FIT HEAD**
Eliminates wobble and screw head roundings
- 2. CONTOURED AREA**
The bit tip flexes with the torque of the impact driver
- 3. FLEX OPTIMISED**
To transfer maximum torque through the screw and maximise life
- 4. MANUFACTURED WITH HEAVY-DUTY HIGH-GRADE STEEL**
To withstand high torque output

IMPACT PRO PHILLIPS® 25MM INSERT BITS



ITEM NO.	DESCRIPTION	EAN	SHELF PACK
Carded			
IW6061301	Impact Pro Screwdriving Bits - Phillips® 25mm Insert Bits 2 x PH1	5054905037130	5
IW6061302	Impact Pro Screwdriving Bits - Phillips® 25mm Insert Bits 2 x PH2	5054905037147	5
IW6061303	Impact Pro Screwdriving Bits - Phillips® 25mm Insert Bits 2 x PH3	5054905037154	5

IMPACT PRO SQUARE RECESS 25MM INSERT BITS



ITEM NO.	DESCRIPTION	EAN	SHELF PACK
Carded			
IW6061201	Impact Pro Screwdriving Bits - Square Recess 25mm Insert Bits 2 x SQ1	5054905037772	5
IW6061202	Impact Pro Screwdriving Bits - Square Recess 25mm Insert Bits 2 x SQ2	5054905037789	5
IW6061203	Impact Pro Screwdriving Bits - Square Recess 25mm Insert Bits 2 x SQ3	5054905037796	5

IMPACT PRO POZI 25MM INSERT BITS



ITEM NO.	DESCRIPTION	EAN	SHELF PACK
Carded			
IW6061407	Impact Pro Screwdriving Bits - Pozi 25mm Insert Bits 2 x PZ2	5054905252458	5
IW6061408	Impact Pro Screwdriving Bits - Pozi 25mm Insert Bits 10 x PZ2	5054905252465	5
IW6061409	Impact Pro Screwdriving Bits - Pozi 25mm Insert Bits 2 x PZ1	5054905252489	5
IW6061410	Impact Pro Screwdriving Bits - Pozi 25mm Insert Bits 10 x PZ1	5054905252533	5
IW6061411	Impact Pro Screwdriving Bits - Pozi 25mm Insert Bits 2 x PZ3	5054905252540	5
IW6061412	Impact Pro Screwdriving Bits - Pozi 25mm Insert Bits 10 x PZ3	5054905252557	5

IMPACT PRO HEX 25MM INSERT BITS



ITEM NO.	DESCRIPTION	EAN	SHELF PACK
Carded			
IW6061101	Impact Pro Screwdriving Bits - Hex 25mm Insert Bits 2 x HEX5	5054905037635	5
IW6061115	Impact Pro Screwdriving Bits - Hex 25mm Power Bits 2 x HEX4	5054905252472	5



IMPACT PRO SLOTTED 25MM INSERT BITS



ITEM NO.	DESCRIPTION	EAN	SHELF PACK
Carded			
IW6061504	Impact Pro Screwdriving Bits - Slotted 25mm Insert Bits 2 x SL6-8	5054905252687	5
IW6061505	Impact Pro Screwdriving Bits - Slotted 25mm Insert Bits 2 x SL8-10	5054905252694	5
IW6061506	Impact Pro Screwdriving Bits - Slotted 25mm Insert Bits 2 x SL10-12	5054905252700	5



IMPACT PRO TORX 25MM INSERT BITS



ITEM NO.	DESCRIPTION	EAN	SHELF PACK
Carded			
IW6061610	Impact Pro Screwdriving Bits - Torx 25mm Insert Bits 2 x T20	5054905252496	5
IW6061611	Impact Pro Screwdriving Bits - Torx 25mm Insert Bits 2 x T25	5054905252502	5
IW6061612	Impact Pro Screwdriving Bits - Torx 25mm Insert Bits 2 x T30	5054905252519	5
IW6061613	Impact Pro Screwdriving Bits - Torx 25mm Insert Bits 2 x T40	5054905252526	5
IW6061614	Impact Pro Screwdriving Bits - Torx 25mm Insert Bits 2 x T10	5054905252564	5
IW6061615	Impact Pro Screwdriving Bits - Torx 25mm Insert Bits 2 x T15	5054905252571	5



IMPACT PRO 25MM INSERT BITS SET



ITEM NO.	DESCRIPTION	EAN	SHELF PACK
Sets			
IW6062503	Impact Pro Screwdriving Bits - Pozzi 25mm Insert Bits 10pc Set: 2 x PZ1, 5 x PZ2, 2 x PZ3 + Bit Holder	5054905252397	5
IW6061607	Impact Pro Screwdriving Bits - Torx 25mm Insert Bits Set: 1 x TR10, 1 x TR15, 1 x TR20, 1 x TR25, 1 x TR27, 1 x TR30	5054905037420	5



IMPACT PRO® PERFORMANCE SERIES

INSERT POWER BITS

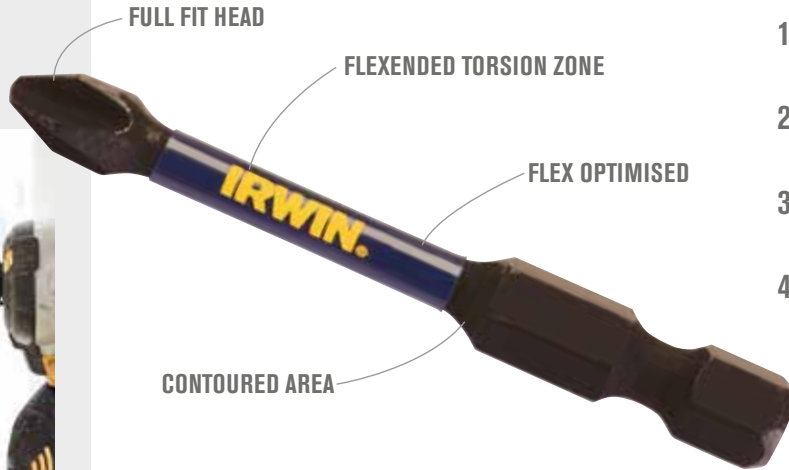

1. **FEXTENDED TORSION ZONE**
Maximising bit life and turning force when used in extreme applications
2. **FULL FIT HEAD**
Eliminates wobble and screw head roundings
3. **CONTOURED AREA**
The bit tip flexes with the torque of the impact driver
4. **FLEX OPTIMISED**
To transfer maximum torque through the screw and maximise life

IMPACT PRO PHILLIPS® 57MM POWER BITS



ITEM NO.	DESCRIPTION	EAN	SHELF PACK
Carded			
IW6061305	Impact Pro Screwdriving Bits - Phillips® 57mm Power Bits 2 x PH1	5054905037178	5
IW6061306	Impact Pro Screwdriving Bits - Phillips® 57mm Power Bits 2 x PH2	5054905037185	5
IW6061308	Impact Pro Screwdriving Bits - Phillips® 57mm Power Bits 5 x PH2	5054905037208	5
IW6061309	Impact Pro Screwdriving Bits - Phillips® 57mm Power Bits 10 x PH2	5054905037215	5
IW6061307	Impact Pro Screwdriving Bits - Phillips® 57mm Power Bits 2 x PH3	5054905037192	5



IMPACT PRO POZI 57MM POWER BITS



ITEM NO.	DESCRIPTION	EAN	SHELF PACK
Carded			
IW6061401	Impact Pro Screwdriving Bits - Pozi 57mm Power Bits 2 x PZ2	5054905037321	5
IW6061413	Impact Pro Screwdriving Bits - Pozi 57mm Power Bits 2 x PZ1	5054905252588	5
IW6061414	Impact Pro Screwdriving Bits - Pozi 57mm Power Bits 2 x PZ3	5054905252595	5



IMPACT PRO SQUARE RECESS 57MM POWER BITS



ITEM NO.	DESCRIPTION	EAN	SHELF PACK
Carded			
IW6061204	Impact Pro Screwdriving Bits - Square Recess 57mm Power Bits 2 x SQ1	5054905037802	5
IW6061205	Impact Pro Screwdriving Bits - Square Recess 57mm Power Bits 2 x SQ2	5054905037819	5
IW6061208	Impact Pro Screwdriving Bits - Square Recess 57mm Power Bits 10 x SQ2	5054905037840	5
IW6061206	Impact Pro Screwdriving Bits - Square Recess 57mm Power Bits 2 x SQ3	5054905037826	5



IMPACT PRO PERFORMANCE SERIES

IMPACT PRO HEX 57MM POWER BITS



ITEM NO.	DESCRIPTION	EAN	SHELF PACK
Carded			
IW6061102	Impact Pro Screwdriving Bits - Hex 57mm Power Bits 2 x HEX4	5054905037642	5
IW6061103	Impact Pro Screwdriving Bits - Hex 57mm Power Bits 2 x HEX5	5054905037659	5
IW6061104	Impact Pro Screwdriving Bits - Hex 57mm Power Bits 2 x HEX6	5054905037666	5



IMPACT PRO TORX 57MM POWER BITS SET



ITEM NO.	DESCRIPTION	EAN	SHELF PACK
Carded			
IW6061601	Impact Pro Screwdriving Bits - Torx 57mm Power Bits Set 2 x T10	5054905037369	5
IW6061602	Impact Pro Screwdriving Bits - Torx 57mm Power Bits Set 2 x T15	5054905037376	5
IW6061603	Impact Pro Screwdriving Bits - Torx 57mm Power Bits Set 2 x T20	5054905037383	5
IW6061604	Impact Pro Screwdriving Bits - Torx 57mm Power Bits Set 2 x T25	5054905037390	5
IW6061608	Impact Pro Screwdriving Bits - Torx 57mm Power Bits Set: T15, T20, T25	5054905037437	5
IW6061618	Impact Pro Screwdriving Bits - Torx 57mm Power Bits 2 x T30	5054905252601	5



IMPACT PRO PHILLIPS® 89MM POWER BITS



ITEM NO.	DESCRIPTION	EAN	SHELF PACK
Carded			
IW6061311	Impact Pro Screwdriving Bits - Phillips® 89mm Power Bits 2 x PH2	5054905037239	5
IW6061312	Impact Pro Screwdriving Bits - Phillips® 89mm Power Bits 5 x PH2	5054905037246	5
IW6061313	Impact Pro Screwdriving Bits - Phillips® 89mm Power Bits 10 x PH2	5054905037253	5



IMPACT PRO SQUARE RECESS 89MM POWER BITS



ITEM NO.	DESCRIPTION	EAN	SHELF PACK
Carded			
IW6061210	Impact Pro Screwdriving Bits - Square Recess 89mm Power Bits 2 x SQ2	5054905037864	5



IMPACT PRO® PERFORMANCE SERIES



IMPACT PRO HEX 89MM POWER BITS



ITEM NO.	DESCRIPTION	EAN	SHELF PACK
Carded			
IW6061108	Impact Pro Screwdriving Bits - Hex 89mm Power Bits 2 x HEX5	5054905037703	5



IMPACT PRO TORX 89MM POWER BITS



ITEM NO.	DESCRIPTION	EAN	SHELF PACK
Carded			
IW6061606	Impact Pro Screwdriving Bits - Torx 89mm Power Bits 5 x T25	5054905037413	5



IMPACT PRO PHILLIPS® 152MM POWER BITS



ITEM NO.	DESCRIPTION	EAN	SHELF PACK
Carded			
IW6061315	Impact Pro Screwdriving Bits - Phillips® 152mm Power Bits 2 x PH2	5054905037277	5
IW6061316	Impact Pro Screwdriving Bits - Phillips® 152mm Power Bits 5 x PH2	5054905037284	5



IMPACT PRO SQUARE RECESS 152MM POWER BITS



ITEM NO.	DESCRIPTION	EAN	SHELF PACK
Carded			
IW6061214	Impact Pro Screwdriving Bits - Square Recess 152mm Power Bits 2 x SQ2	5054905037109	5



IMPACT PRO HEX 152MM POWER BITS



ITEM NO.	DESCRIPTION	EAN	SHELF PACK
Carded			
IW6061112	Impact Pro Screwdriving Bits - Hex 152mm Power Bits 2 x HEX5	5054905037741	5

IMPACT PRO PERFORMANCE SERIES

NUTSETTERS



- 1. LOBULAR DESIGN**
Drives fastener on side instead of corner for less stripping and longer life
- 2. RARE EARTH MAGNETS**
Hold fasteners securely with 4X the hold of standard magnets
- 3. 1/4" QUICK-CHANGE SHANK**
Designed to work with impact drivers, and reduces slipping in standard drill chucks

IMPACT PRO NUTSETTERS

ITEM NO.	DESCRIPTION	LENGTH	EAN	SHELF PACK
Carded				
IW6069102	Impact Pro Nutsetter 1 x 6mm (1/4")	65mm	5054905037505	5
IW6069103	Impact Pro Nutsetter 1 x 8mm (5/16")	65mm	5054905037512	5
IW6069104	Impact Pro Nutsetter 1 x 9.5mm (3/8")	65mm	5054905037529	5
IW6069105	Impact Pro Nutsetter 1 x 6mm (1/4")	152mm	5054905037536	5
IW6069106	Impact Pro Nutsetter 1 x 8mm (5/16")	152mm	5054905037543	5
IW6069107	Impact Pro Nutsetter 1 x 9.5mm (3/8")	152mm	5054905037550	5
IW6069114	Impact Pro Nutsetter x1 7mm (9/32")	65mm	5054905252618	3
IW6069115	Impact Pro Nutsetter x1 8mm (5/16")	65mm	5054905252625	3
IW6069116	Impact Pro Nutsetter x1 10mm (25/64")	65mm	5054905252632	3
IW6069117	Impact Pro Nutsetter x1 7mm (9/32")	152mm	5054905252649	5
IW6069118	Impact Pro Nutsetter x1 8mm (5/16")	152mm	5054905252656	5
IW6069119	Impact Pro Nutsetter x1 10mm (25/64")	152mm	5054905252663	5
Sets				
IW6069101	Impact Pro Nutsetter Set: 6mm (1/4"), 8mm (5/16"), 9.5mm (3/8")	65mm	5054905037499	5
IW6069120	Impact Pro Nutsetter Set: 7mm (9/32"), 8mm (5/16"), 10mm (25/64")	65mm	5054905252670	3



IMPACT PRO PERFORMANCE SERIES

IMPACT PRO HOLDER



ITEM NO.	DESCRIPTION	LENGTH	EAN	SHELF PACK
Carded				
IW6064604	Impact Pro Performance Magnetic Collar	30mm	5054905037628	5
IW6064603	Impact Pro Performance Magnetic Torsion Bit Holder	75mm	5054905037482	5

IMPACT PRO ACCESSORIES



ITEM NO.	DESCRIPTION	LENGTH	EAN	SHELF PACK
Carded				
IW6064601	Impact Pro Right Angle Chuck	5	5054905238995	5
IW6064602	Impact Pro Flexible Right Angled Extension	5	5054905239008	5
IW6064605	Impact Pro Keyless Chuck	5	5054905239015	5



QUICK-CHANGE IMPACT BIT EXTENSIONS

Have a patented jaw design that is compatible with all 1/4" hex shank accessories including insert bits

ITEM NO.	DESCRIPTION	EAN	MASTER PACK	SHELF PACK
IW6064607	Impact Quick-Change Extension Bit - 12" - 1pc	5054905252434	48	5

IMPACT PRO PERFORMANCE SERIES

IMPACT PRO PERFORMANCE STORAGE SETS

Keep bits, adaptors and accessories close to hand with the new range of IRWIN® storage sets. Designed to withstand the rigours of daily use, the cases are available in three different sizes; each of which can connect together to provide a secure storage unit.

ROBUST, MODULAR, STORAGE THAT KEEPS BITS AND ACCESSORIES ORGANISED AND EASY TO FIND



- 1. EASY BIT REMOVAL**
Small cases include newly designed bit retainers for easy removal and replacement
- 2. ROBUST CASE**
Designed to hold up against the rigours of daily use
- 3. SECURE CLOSURE**
Easy-to-use flip-up latch design keeps cases securely closed when not in use and locks the cases together when stacked
- 4. CONNECTABLE CASES - FLEXIBLE STORAGE**
The connectable cases can be customised to create a single storage unit that is both secure and portable

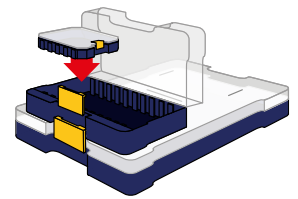
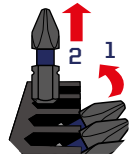

IMPACT PRO PERFORMANCE SMALL STORAGE SETS

ITEM NO.	DESCRIPTION	EAN	MASTER PACK	SHELF PACK
IW6061622	Small case Impact Pro 44pc 25mm T20-T30 set: 3x small bulk cases. 25mm x20 T20/ x20 T30. 57mm x2 T20, x2 Magnetic Torsion bit holder	5054905247959	5	5
IW6062506	Small case Impact Pro 22pc 57mm set: x2 PH1/x4 PH2/x1 PH3/x2 Pz1/x5 Pz2/x1 Pz3/x4 T20/x3 T30	5054905252694	5	5
IW6062507	Small case Impact Pro 32pc set: 25mm: x2 PH1/x3 PH2/x2 PH3/x2 Pz1/x3 Pz2/x2 Pz3/x3 T20/x2 T25/x2 T30 57mm: x5 PH2/x5 Pz2 x1 3 inch bit holder	5054905252700	5	5



IW6062506

IMPACT PRO PERFORMANCE SMALL BULK SETS

ITEM NO.	DESCRIPTION	EAN	MASTER PACK	SHELF PACK
IW6061619	Small Bulk Set Impact Pro 25mm T30 x 20	5054905247928	4	4
IW6061620	Small Bulk Set Impact Pro 25mm T20 x 20	5054905247935	4	4
IW6061415	Small Bulk Set Impact Pro 25mm Pz2 x 20	5054905247904	4	4
IW6061416	Small Bulk Set Impact Pro 25mm Pz20 x 20 + holder	5054905247911	5	5
IW6061323	Small Bulk Set Impact Pro 25mm Ph2 x 20 + holder	5054905247898	5	5
IW6061621	Small Bulk Set Impact Pro 25mm T20 x 20 + holder	5054905247942	5	5



IW6061619

*Medium storage set available as Blue Groove and Speedhammer Plus drill bit sets



SCREWDRIVING BITS

IRWIN® offers a full line of screwdriving bits designed for a number of applications. All bits are manufactured with industrial-grade S2 steel for long life and durability. Insert bits are engineered for use in hand-driving applications or with power tools when used with the IRWIN® insert bit holder. Power bits are specifically designed for the higher torque requirements of power tools. They are designed to provide more clearance between the power tool and the fastener.

PHILLIPS, INSERT BITS



10504388

ITEM NO.	DESCRIPTION	EAN	MASTER PACK	SHELF PACK
10504387	Phillips Ph1 - 1/4"/25mm - 2 pcs	5706915043877	10	1
10504388	Phillips Ph2 - 1/4"/25mm - 2 pcs	5706915043884	10	1
10504389	Phillips Ph3 - 1/4"/25mm - 2 pcs	5706915043891	10	1
10504390	Phillips Ph1 - 1/4"/50mm - 2 pcs	5706915043907	10	1
10504391	Phillips Ph2 - 1/4"/50mm - 2 pcs	5706915043914	10	1
10504336	Phillips Ph2 - 1/4"/50mm - 5 pcs	5706915043365	10	1
10504330	Phillips Ph1 - 1/4"/25mm - 10 pcs	5706915043303	10	1
10504331	Phillips Ph2 - 1/4"/25mm - 10 pcs	5706915043310	10	1
10504332	Phillips Ph3 - 1/4"/25mm - 10 pcs	5706915043327	10	1

PHILLIPS, INSERT BITS - TITANIUM COATED



10504392

ITEM NO.	DESCRIPTION	EAN	MASTER PACK	SHELF PACK
10504392	Phillips Ph2 TiN - 1/4"/25mm - 2 pcs	5706915043921	10	1
10504334	Phillips Ph2 TiN - 1/4"/25mm - 10 pcs	5706915043341	10	1

PHILLIPS, POWER BITS



10504396

ITEM NO.	DESCRIPTION	EAN	MASTER PACK	SHELF PACK
10504396	Phillips Ph2 - 1/4"/50mm - 2 pcs	5706915043969	10	1
10504365	Phillips Ph2 - 1/4"/70mm - 1 pcs	5706915043655	10	1
10504366	Phillips Ph2 - 1/4"/90mm - 1 pcs	5706915043662	10	1

POZIDRIV, INSERT BITS



10504398

ITEM NO.	DESCRIPTION	EAN	MASTER PACK	SHELF PACK
10504397	Pozidriv Pz1 - 1/4"/25mm - 2 pcs	5706915043976	10	1
10504398	Pozidriv Pz2 - 1/4"/25mm - 2 pcs	5706915043983	10	1
10504399	Pozidriv Pz3 - 1/4"/25mm - 2 pcs	5706915043990	10	1
10504401	Pozidriv Pz2 - 1/4"/50mm - 2 pcs	5706915044010	10	1
10504338	Pozidriv Pz1 - 1/4"/25mm - 10 pcs	5706915043389	10	1
10504339	Pozidriv Pz2 - 1/4"/25mm - 10 pcs	5706915043396	10	1
10504340	Pozidriv Pz3 - 1/4"/25mm - 10 pcs	5706915043402	10	1
10504344	Pozidriv Pz2 - 1/4"/50mm - 5 pcs	5706915043440	10	1

POZIDRIV, INSERT BITS - TITANIUM COATED



10504402

ITEM NO.	DESCRIPTION	EAN	MASTER PACK	SHELF PACK
10504402	Pozidriv Pz2 TiN - 1/4"/25mm - 2 pcs	5706915044027	10	1
10504341	Pozidriv Pz1 TiN - 1/4"/25mm - 10 pcs	5706915043419	10	1
10504342	Pozidriv Pz2 TiN - 1/4"/25mm - 10 pcs	5706915043426	10	1
10504343	Pozidriv Pz3 TiN - 1/4"/25mm - 10 pcs	5706915043433	10	1

* Bulk packed products are priced per single item and can only be ordered in multiples of shelf pack quantity

POZIDRIV, POWER BITS

ITEM NO.	DESCRIPTION	EAN	MASTER PACK	SHELF PACK
10504370	Pozidriv Pz2 - 1/4"/70mm - 1 pcs	5706915043709	10	1
10504371	Pozidriv Pz2 - 1/4"/90mm - 1 pcs	5706915043716	10	1
10504372	Pozidriv Pz3 - 1/4"/50mm - 5 pcs	5706915043723	10	1



10504406

TORX, INSERT BITS

ITEM NO.	DESCRIPTION	EAN	MASTER PACK	SHELF PACK
10504837	Torx T15 - 1/4"/25mm - 2 pcs	5706915048377	200	10
10504838	Torx T20 - 1/4"/25mm - 2 pcs	5706915048384	200	10
10504839	Torx T25 - 1/4"/25mm - 2 pcs	5706915048391	200	10
10504840	Torx T30 - 1/4"/25mm - 2 pcs	5706915048407	200	10
10504351	Torx T10 - 1/4"/25mm - 10 pcs	5706915043518	10	1
10504352	Torx T15 - 1/4"/25mm - 10 pcs	5706915043525	10	1
10504353	Torx T20 - 1/4"/25mm - 10 pcs	5706915043532	10	1
10504354	Torx T25 - 1/4"/25mm - 10 pcs	5706915043549	10	1
10504355	Torx T27 - 1/4"/25mm - 10 pcs	5706915043556	10	1
10504356	Torx T30 - 1/4"/25mm - 10 pcs	5706915043563	10	1
10504357	Torx T40 - 1/4"/25mm - 10 pcs	5706915043570	10	1



10504840

TORX, POWER BITS

ITEM NO.	DESCRIPTION	EAN	MASTER PACK	SHELF PACK
10504373	Torx T20 - 1/4"/50mm - 5 pcs	5706915043730	10	1
10504374	Torx T25 - 1/4"/50mm - 5 pcs	5706915043747	10	1
10504375	Torx T30 - 1/4"/50mm - 5 pcs	5706915043754	10	1
10504376	Torx T40 - 1/4"/50mm - 5 pcs	5706915043761	10	1



10504375

SLOTTED, INSERT BITS

ITEM NO.	DESCRIPTION	EAN	MASTER PACK	SHELF PACK
10504358	Slotted 0,5 x 3,0mm - 1/4"/25mm - 10 pcs	5706915043587	60	10
10504362	Slotted 1,6 x 8,0mm - 1/4"/25mm - 10 pcs	5706915043624	60	10

HEXAGONAL, INSERT BITS

ITEM NO.	DESCRIPTION	EAN	MASTER PACK	SHELF PACK
10504346	Hexagonal 3,0mm - 1/4"/25mm - 10 pcs	5706915043464	60	10
10504347	Hexagonal 4,0mm - 1/4"/25mm - 10 pcs	5706915043471	60	10

GRABIT JARS

ITEM NO.	DESCRIPTION	EAN	MASTER PACK	SHELF PACK
10504383	Grabit Jar Pozidriv Pz2 - 1/4"/25mm, 250 pcs	5706915043839	4	1
10504384	Grabit Jar Phillips Ph2 - 1/4"/25mm, 250 pcs	5706915043846	4	1



10504384

POCKET CASES

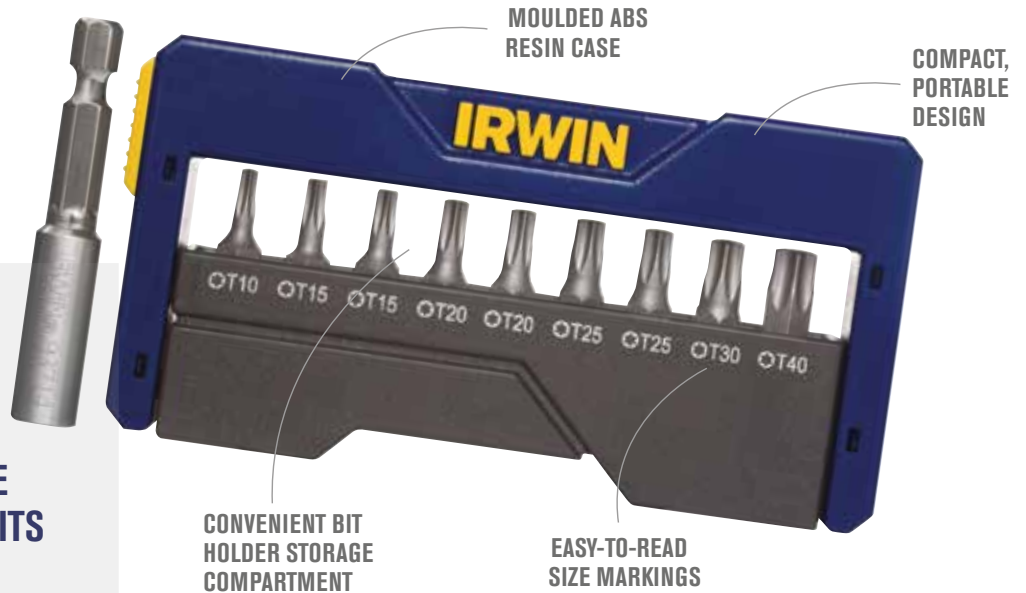

PORTABLE, DURABLE CASE THAT KEEPS BITS ORGANISED

IRWIN® Pocket Cases feature a compact, portable design that makes it simple to take the bits you need to get the job done. The convenient moulded ABS resin cases hold up to anything the jobsite can throw at them and include easy-to-read size markings for simple identification of the set contents. Plus, the 10-piece pocket case features an easy-to-access bit holder storage compartment right on top.

- 1. COMPACT, PORTABLE DESIGN**
Compact, portable design allows for easy transport to and from the worksite, and ease-of-use while on the job
- 2. MOULDED ABS RESIN CASE**
Moulded ABS resin case holds up to rigors of daily use
- 3. EASY-TO-READ SIZE MARKINGS**
Easy-to-read size markings provide simple identification of set contents
- 4. CONVENIENT BIT HOLDER STORAGE COMPARTMENT**
Incorporated into top of case (insert bit cases only)



LARGE POCKET CASES

ITEM NO.	DESCRIPTION	EAN	MASTER PACK	SHELF PACK
1868197	IR 10PC IB Pocket Set (TX): IB Torx, 10pc set: T10/2xT15/2xT20/2xT25/T30/T40 + Bit Holder	5706918681977	-	6
IW6062504	Impact Insert Bit Mixed Set, 10pcs: 4 x PZ2 / 4 x PH2 / T20 + Bit Holder	5054905252403	36	6



IMPACT POWER BIT 5 PIECE POCKET CASE SET

Holds (5) 2" power bits

ITEM NO.	DESCRIPTION	EAN	MASTER PACK	SHELF PACK
IW6061404	Impact Power Bit PZ Set, 5pcs: PZ2 x 5	5054905252410	-	5

DRAWER CASES



EASY-TO-READ
SIZE MARKINGS

SECURE CLOSURE

COMPACT, PORTABLE
DESIGN

MOULDED ABS
RESIN CASE

COMPACT, EASY-TO-STORE CASE THAT CAN ORGANISE A WIDE VARIETY OF BITS

IRWIN® Drawer Cases feature a compact, flat design for enhanced portability and convenient storage in drawers and tool cabinets. The durable moulded ABS resin cases hold up to the daily rigors of shop-life and anything the jobsite can throw at them. The easy-to-read size markings make for simple identification of the set contents, and when not in use, the case stays securely closed with an easy-to-use sliding latch.

- 1. COMPACT, PORTABLE DESIGN**
Compact, flat design for convenient storage in drawers and tool cabinets
- 2. MOULDED ABS RESIN CASE**
Moulded ABS resin case holds up to rigors of daily use
- 3. EASY-TO-READ SIZE MARKINGS**
Easy-to-read size markings provide simple identification of set contents
- 4. SECURE CLOSURE**
Easy-to-use sliding latch design keeps case securely close when not in use

SMALL DRAWER CASES

ITEM NO.	DESCRIPTION	EAN	MASTER PACK	SHELF PACK
1868251	IR 30PC SL DRAWER SET ASSORTED: IB assorted, 31pc small drawer case: PH1/2xPH2/PH3/PZ1/2xPZ2/PZ3/SL4-5/SL6-8/SL8-10/HEX4/HEX5/ HEX6/2xT10/4xT15/4xT20/3xT25/2xT30/T40 + Bit Holder	5706918682516	-	6

LARGE DRAWER CASES

ITEM NO.	DESCRIPTION	EAN	MASTER PACK	SHELF PACK
1868252	IR 58PC LG DRAWER SET ASSORTED: IB/PB assorted, 58pc large drawer case: 3xPH1/10xPH2/2xPH3/3xPZ1/10xPZ2/2xPZ3/SL3-4/SL4-5/SL6-8/SL8-10/HEX3/HEX4/HEX5/ HEX6/2xT10/2xT15/2xT20/2xT25/2xT30/2xT40 + Powerbits PH2/PZ1/PZ2/PZ3/T15/T20/T25 + Bit Holder	5706918682523	-	6



1868252



SMALL STORAGE CASES MIXED SETS

EASY BIT REMOVAL

ROBUST CASE

FIT TOGETHER WITH SMALL BULK SETS AND MEDIUM STORAGE CASES TO KEEP EVERYTHING YOU NEED SECURE AND IN ONE PLACE

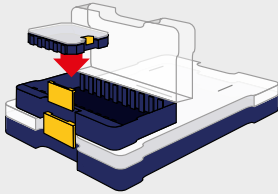

SECURE CLOSURE

CONNECTABLE CASES - FLEXIBLE STORAGE

- 1. EASY BIT REMOVAL**
Small cases include newly designed bit retainers for easy removal and replacement
- 2. ROBUST CASE**
Designed to hold up against the rigours of daily use
- 3. SECURE CLOSURE**
Easy-to-use flip-up latch design keeps cases securely closed when not in use and locks the cases together when stacked
- 4. CONNECTABLE CASES - FLEXIBLE STORAGE**
The connectable cases can be customised to create a single storage unit that is both secure and portable

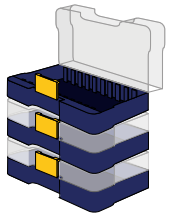
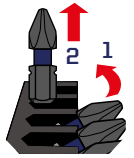

ITEM NO.	DESCRIPTION	EAN	MASTER PACK	SHELF PACK
IW6062508	Small Case 30pc Mixed Screwdriver: 25mm bits: PH1 x 1, PH2 x 5, PH3 x 1, Pz1 x 1, Pz2 x 5, Pz3 x 1, T20 x 1, T25 x 1, T30 x 1, T40 x 1, SL8 x 1, SL10 x 1, SL12 x 1 50mm Bits: PH2 x 1, Pz1 x 1, Pz2 x 2, Magnetic Torsion Bit holder x 1, Nut setters x 4 (6,7,8,10)	5054905247980	5	5
IW6062509	Small Case 31pc Mixed Screwdriver Set: 25mm bits: PH1 x 1, PH2 x 5, PH3 x 1, Pz1 x 1, Pz2 x 5, Pz3 x 1, T20 x 2, T30 x 2, SL6 x 1, SL8 x 1, SL10 x 1 50mm bits: PH2 x 3, Pz2 x 3, T20 x 3, Magnetic Bit holder x1	5054905247997	5	5
IW6062510	Small Case 40pc Mixed Screwdriver Set: 25mm bits: PH1 x 1, PH2 x 2, PH3 x 2, Pz1 x1, Pz2 x 5, Pz3 x 3, T10 x 1, T15 x 1, T20 x 2, T25 x 2, T30 x 1 Nut setters x2 (8,10mm.) 50mm bits: PH1 x 1, PH2 x 2, PH3 x 1 Pz1 x 1, Pz2 x 4, Pz3 x 1 T15 x 1, T20 x 1, T25 x 2, T30 x 2, Magnetic bit holder x1	5054905248000	5	5

BIT HOLDERS



10504377



10504381



10504380



1923228

ITEM NO.	DESCRIPTION	EAN	MASTER PACK	SHELF PACK
10504377	50mm Magnetic Bit Holder 1/4"	5706915043778	200	10
10504381	80mm Screw Drive Guide 9.5mm diameter	5706915043815	200	10
10504380	Quick-Release Bit Holder 1/4"	5706915043808	200	10

IMPACT BIT HOLDERS

Impact bit holders and attachments feature rare earth magnets which are four times more powerful than standard magnets to hold fasteners securely

ITEM NO.	DESCRIPTION	EAN	MASTER PACK	SHELF PACK
1923228	Impact Bit Holder- 3" - 1pc	5706919232284	25	5
IW6064606	Impact Bit Holder- 6" - 1pc	5054905252427	25	5

BOLT-GRIP™ BOLT EXTRACTORS

Professionals don't waste time fighting rounded-off, rusted tight or painted-over bolts. They reach for the BOLT-GRIP. A unique, reverse spiral flute design securely grips and removes stubborn nuts and bolts.



54125



10504634



10504635



394100

ITEM NO.	DESCRIPTION	EAN	MASTER PACK	SHELF PACK
10504634	5 Piece Base Set: 3/8", 7/16" (11mm), 1/2", 9/16" (14mm), 5/8" (16mm)	0024721012579	-	5
10504635	5 Piece Expansion Set: 5/16" (8mm), 10mm, 13mm, 11/16", 3/4" (19mm)	0024721016126	-	5
394100	Powergrip Set: 3/16" - 1/2", 7 pcs	0024721037633	-	5
54125	5 Piece Speciality Set: 3/4" (19mm), 13/16" (21mm), 7/8" (22mm), 15/16" (24mm), 1" (25mm)	0024721541253	-	1

MAXIMUM GRIPPING POWER reverse spiral flutes are designed to bite down

HIGH CARBON STEEL is tougher than tool steel, ensuring longer life and greater durability

WORKS WITH MOST TOOLS with a 3/8" square drive for use with hand ratchets, impact wrenches & air ratchets; hexagonal flats for use with flat wrench, pliers, adjustable wrench, sockets or VISE-GRIP® locking pliers

UNIVERSAL LOBULAR DESIGN fits all types of fasteners





CIRCULAR SAW BLADES

IRWIN® now offers a comprehensive line-up of circular saw blades for professional tool users. From the jobsite, to the fine woodworking shop, IRWIN® offers a blade for every user need.

WELDTEC™

The WeldTec™ platform redefines excellence with a range of construction saw blades that combines various attributes to deliver long lasting performance.

WeldTec Technology is the welding of teeth to the circular saw blade as opposed to the traditional brazing method. This is ideal for handheld corded and cordless blades as the weld provides a stronger tooth bond in case of unexpected nail strikes or foreign objects embedded in wood.



HAND-HELD

STATIONARY

CORDLESS

CORDED

MITRE

TABLE



CONSTRUCTION CIRCULAR SAW BLADES

CONSTRUCTION GRADE TUNGSTEN CARBIDE TIPS for longer life and are resharpenable

#400 GRIT DIAMOND GROUND TEETH for a smooth finish

EXPANSION SLOTS to dissipate heat and prevent warping

THIN KERF for fast cuts and longer motor life

CORROSION-RESISTANT COATING for longer, quality performance

ALTERNATE TOP BEVEL TOOTH CONFIGURATION (ATB) for cross cutting and ripping in all woods

TRIPLE CHIP GRIND TOOTH CONFIGURATION (TCG) for cutting hard materials like laminates, MDF, plastics and non-ferrous metals



1897448

ITEM NO.	DESCRIPTION	CATEGORY	MACHINES	DIAMETER	TOOTH COUNT	ARBOR/BORE	KERF THICKNESS	TOOTH CONFIG.
1897395	Construction 216mm/24T M	Stationary	Mitre	216	24	30	2.0	ATB
1897396	Construction 216mm/48T M	Stationary	Mitre	216	48	30	2.0	ATB
1897397	Construction 216mm/60T M	Stationary	Mitre	216	60	30	2.0	ATB
1897398	Construction 250mm/48T M	Stationary	Mitre	250	48	30	2.8	ATB
1897426	Construction 250mm/60T M	Stationary	Mitre	250	60	30	2.8	ATB
1897427	Construction 250mm/80T M	Stationary	Mitre	250	80	30	2.8	ATB
1897428	Construction 254mm/48T M	Stationary	Mitre	254	48	30	2.8	ATB
1897429	Construction 254mm/60T M	Stationary	Mitre	254	60	30	2.8	ATB
1897430	Construction 254mm/80T M	Stationary	Mitre	254	80	30	2.8	ATB
1897431	Construction 260mm/48T M	Stationary	Mitre	260	48	30	2.8	ATB
1897432	Construction 260mm/60T M	Stationary	Mitre	260	60	30	2.8	ATB
1897433	Construction 260mm/80T M	Stationary	Mitre	260	80	30	2.8	ATB
1897434	Construction 305mm/48T M	Stationary	Mitre	305	48	30	3.2	ATB
1897435	Construction 305mm/60T M	Stationary	Mitre	305	60	30	3.2	ATB
1897436	Construction 305mm/80T M	Stationary	Mitre	305	96	30	3.2	ATB
1897448	Construction 250mm/24T	Stationary	Table & Mitre	250	24	30	3.2	ATB
1897449	Construction 250mm/40T	Stationary	Table & Mitre	250	40	30	3.2	ATB
1897450	Construction 250mm/60T	Stationary	Table & Mitre	250	60	30	3.2	ATB
1897451	Construction 300mm/48T	Stationary	Table & Mitre	300	48	30	3.2	ATB
1897452	Construction 300mm/60T	Stationary	Table & Mitre	300	60	30	3.2	ATB
1897437	MM CSB 160mm/48T	Multi	Handheld (corded)	160	48	20	2	TCG
1897438	MM CSB 165mm/48T	Multi	Handheld (corded)	165	48	30	2	TCG
1897439	MM CSB 184mm/48T	Multi	Handheld (corded)	184	48	30	2	TCG
1897440	MM CSB 190mm/48T	Multi	Handheld (corded)	190	48	30	2	TCG
1897441	MM CSB 210mm/84T	Multi	Handheld (corded)/Mitre	210	60	30	3	TCG
1897442	MM CSB 216mm/84T	Multi	Mitre	216	84	30	3	TCG
1897443	MM CSB 250mm/84T	Multi	Sliding Mitre/Mitre	250	84	30	3	TCG
1897444	MM CSB 254mm/84T	Multi	Sliding Mitre/Mitre	254	84	30	3	TCG
1897445	MM CSB 260mm/84T	Multi	Sliding Mitre/Mitre	260	84	30	3	TCG
1897446	MM CSB 300mm/96T	Multi	Table	300	96	30	3	TCG
1897447	MM CSB 305mm/84T	Multi	Sliding Mitre/Mitre	305	84	30	3	TCG

GENERAL PURPOSE CIRCULAR SAW BLADES

ITEM NO.	DESCRIPTION	CATEGORY	MACHINES	DIAMETER	TOOTH COUNT	ARBOR/BORE	KERF THICKNESS	TOOTH CONFIG.
1897209	CSB 216mm/24T M	Stationary	Mitre	216	48	30	2.5	ATB
1897210	CSB 250mm/24T	Stationary	Table & Mitre	250	24	30	3.0	ATB
1897211	CSB 250mm/40T	Stationary	Table & Mitre	250	40	30	3.0	ATB
1907700	CSB 250mm/60T	Stationary	Table & Mitre	250	60	30	3.0	ATB
1897212	CSB 300mm/48T	Stationary	Table & Mitre	300	48	30	3.2	ATB
1897213	CSB 300mm/60T	Stationary	Table & Mitre	300	60	30	3.2	ATB
1897214	CSB 315mm/40T	Stationary	Table & Mitre	315	40	30	3.2	ATB
1897215	CSB 350mm/40T	Stationary	Table & Mitre	350	40	30	3.5	ATB
1897346	CSB 350mm/84T	Stationary	Table & Mitre	350	84	30	3.5	ATB
1897347	CSB 400mm/40T	Stationary	Table & Mitre	400	40	30	3.8	ATB
1897348	CSB 400mm/60T	Stationary	Table & Mitre	400	60	30	3.8	ATB

BEST VALUE for an economy blade
PRECISION GROUND TEETH for smooth, accurate cuts
EXPANSION SLOTS for straighter cuts
CORROSION-RESISTANT COATING for longer, quality performance
ALTERNATE TOP BEVEL TOOTH CONFIGURATION (ATB) for cross cutting and ripping in all woods



1907700





WELDTEC CIRCULAR SAW BLADES

WELDTEC CIRCULAR SAW BLADES



WELDED CARBIDE TEETH

ULTRA-COMPACT (UC2) CARBIDE

INNOVATIVE HEAT VENTS & EXPANSION SLOTS

ALTERNATE TOP BEVEL (ATB) TOOTH CONFIGURATION

FULLY HARDENED PLATE & REINFORCED SHOULDER



1. WELDED CARBIDE TEETH

Up to 30% stronger tooth bond and for 50% longer life

2. ULTRA-COMPACT (UC2) CARBIDE

70% tougher than standard carbide for superior sharpness and cut quality

3. INNOVATIVE HEAT VENTS & EXPANSION SLOTS

For straighter cuts

4. FULLY HARDENED PLATE & REINFORCED SHOULDER

For blade durability and truer, longer running with more accuracy

5. ALTERNATE TOP BEVEL (ATB) TOOTH CONFIGURATION

For cross cutting and ripping in all woods

SKU CODE	DESCRIPTION	CATEGORY	MACHINES	DIAMETER	TOOTH COUNT	ARBOR/BORE	REDUCTIONS	KERF THICKNESS	TOOTH CONFIG.
1897349	Weldtec CSB 150mm/24T	Handheld	Corded	150	24	20	16	2.4	ATB
1897350	Weldtec CSB 150mm/40T	Handheld	Corded	150	40	20	16	2.4	ATB
1897361	Weldtec CSB 160mm/18T	Handheld	Corded	160	18	20	16	2.4	ATB
1897362	Weldtec CSB 160mm/24T	Handheld	Corded	160	24	20	16	2.4	ATB
1897363	Weldtec CSB 160mm/40T	Handheld	Corded	160	40	20	16	2.4	ATB
1897364	Weldtec CSB 165mm/18T	Handheld	Corded	165	18	30	20	2.4	ATB
1897365	Weldtec CSB 165mm/24T	Handheld	Corded	165	24	30	20	2.4	ATB
1897366	Weldtec CSB 165mm/40T	Handheld	Corded	165	40	30	20	2.4	ATB
1897368	Weldtec CSB 184mm/24T AR30	Handheld	Corded	184	24	30	20	2.4	ATB
1897369	Weldtec CSB 184mm/24T AR16	Handheld	Corded	184	24	16	-	2.4	ATB
1897370	Weldtec CSB 184mm/40T AR30	Handheld	Corded	184	40	30	20	2.4	ATB
1897381	Weldtec CSB 184mm/40T AR16	Handheld	Corded	184	40	16	-	2.4	ATB
1897382	Weldtec CSB 190mm/18T	Handheld	Corded	190	18	30	20	2.4	ATB
1897383	Weldtec CSB 190mm/24T	Handheld	Corded	190	24	30	20	2.4	ATB
1897384	Weldtec CSB 190mm/40T	Handheld	Corded	190	40	30	20	2.4	ATB
1897385	Weldtec CSB 210mm/24T	Handheld	Corded	210	24	30	20	2.4	ATB
1897386	Weldtec CSB 210mm/40T	Handheld	Corded	210	40	30	20	2.4	ATB
1897387	Weldtec CSB 235mm/20T	Handheld	Corded	235	20	30	20	2.4	ATB
1897388	Weldtec CSB 235mm/40T	Handheld	Corded	235	40	30	20	2.4	ATB
1897389	Weldtec CSB 235mm/60T	Handheld	Corded	235	60	30	20	2.4	ATB
1897390	Weldtec CSB 136mm/18T C	Handheld	Cordless	136	18	10	-	1.8	ATB
1897391	Weldtec CSB 136mm/24T C	Handheld	Cordless	136	24	10	-	1.8	ATB
1897392	Weldtec CSB 165mm/18T C	Handheld	Cordless	165	18	20	16	1.8	ATB
1897393	Weldtec CSB 165mm/24T C	Handheld	Cordless	165	24	20	16	1.8	ATB
1897394	Weldtec CSB 165mm/40T C	Handheld	Cordless	165	40	20	16	1.8	ATB

ATB ALTERNATE TOP BEVEL

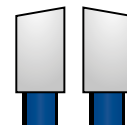

FEATURES

- Teeth alternate between a right- and left-hand bevel to form a knife-like edge on either side for a cleaner cut.

HAND-HELD CONSTRUCTION

THIN KERF WITH EVO ALTERNATING GRIND for fast cutting speed

HEAT VENTS & EXPANSION SLOTS reduce heat build-up and warping

CONSTRUCTION GRADE TUNGSTEN CARBIDE TIPS

retain their edge and deliver longer life

CORROSION-RESISTANT COATING for longer, quality performance

ALTERNATE TOP BEVEL TOOTH CONFIGURATION (ATB) for cross cutting and ripping in all woods



1897200

ITEM NO	DESCRIPTION	CATEGORY	MACHINES	DIAMETER	TOOTH COUNT	ARBOR/BORE	KERF THICKNESS	TOOTH CONFIG.
1897086	125mm/16T	Handheld	Corded	125	16	20	2.5	ATB
1897087	130mm/20T	Handheld	Corded	130	20	20	2.5	ATB
1897088	140mm/20T	Handheld	Corded	140	20	20	2.5	ATB
1897089	150mm/18T	Handheld	Corded	150	18	20	2.5	ATB
1897090	150mm/30T	Handheld	Corded	150	30	20	2.5	ATB
1897191	160mm/18T	Handheld	Corded	160	18	20	2.5	ATB
1897192	160mm/30T	Handheld	Corded	160	30	20	2.5	ATB
1907698	160mm/24T	Handheld	Corded	160	24	30	2.5	ATB
1897193	165mm/18T	Handheld	Corded	165	18	30	2.5	ATB
1897194	165mm/30T	Handheld	Corded	165	30	30	2.5	ATB
1897195	180mm/24T	Handheld	Corded	180	24	30	2.5	ATB
1897196	180mm/36T	Handheld	Corded	180	36	30	2.5	ATB
1907699	184mm/24T	Handheld	Corded	184	24	16	2.5	ATB
1897197	184mm/24T	Handheld	Corded	184	24	30	2.5	ATB
1897198	184mm/40T	Handheld	Corded	184	40	30	2.5	ATB
1897199	190mm/24T	Handheld	Corded	190	24	30	2.5	ATB
1897200	190mm/40T	Handheld	Corded	190	40	30	2.5	ATB
1897201	200mm/24T	Handheld	Corded	200	24	30	2.5	ATB
1897202	200mm/40T	Handheld	Corded	200	40	30	2.5	ATB
1897203	210mm/20T	Handheld	Corded	210	20	30	2.5	ATB
1897204	210mm/40T	Handheld	Corded	210	40	30	2.5	ATB
1897205	230mm/24T	Handheld	Corded	230	24	30	2.8	ATB
1897206	230mm/40T	Handheld	Corded	230	40	30	2.8	ATB
1897207	235mm/20T	Handheld	Corded	235	20	30	2.8	ATB
1897208	235mm/40T	Handheld	Corded	235	40	30	2.8	ATB

SPECIALITY BLADES FOR NON-FERROUS METAL

EXPANSION SLOTS help keep the blade flat

TRIPLE CHIP GROUND TOOTH (TCG) for excellent finish of the cut

SPECIALLY DESIGNED for cutting all types of non-ferrous metals such as aluminium, copper, lead and plastics



1907778

ITEM NO	DESCRIPTION	CATEGORY	MACHINES	DIAMETER	TOOTH COUNT	ARBOR/BORE	KERF THICKNESS	TOOTH CONFIG.
1907772	Aluminium 160 x 56 x 20	Speciality	Speciality	160	56	20	2.5	TCG
1907773	Aluminium 184 x 48 x 30	Speciality	Speciality	184	48	30	2.5	TCG
1907774	Aluminium 200 x 60 x 30	Speciality	Speciality	200	60	30	2.5	TCG
1907775	Aluminium 210 x 60 x 30	Speciality	Speciality	210	60	30	2.5	TCG
1907777	Aluminium 216 x 60 x 30	Speciality	Speciality	216	60	30	2.5	TCG
1907778	Aluminium 250 x 80 x 30	Speciality	Speciality	250	80	30	2.5	TCG
1907779	Aluminium 250 x 100 x 30	Speciality	Speciality	250	100	30	2.5	TCG
1907781	Aluminium 300 x 96 x 30	Speciality	Speciality	300	96	30	2.5	TCG
1907782	Aluminium 350 x 84 x 30	Speciality	Speciality	350	84	30	2.5	TCG

CIRCULAR SAW BLADES

SELECTION CHART

	DIAMETER	TOOTH	BORE	BLADE	SKU	HARDWOODS	SOFTWOODS	NAIL EMBEDDED	PLYWOOD	LAMINATED PLYWOOD	PARTICLE BOARD	DELICATE MOULDING	LAMINATES	BILAMINATE PANELS (DOUBLE-SIDED LAMINATES)	CONGLOMERATES (COMPOSITES)	MDF	MELAMINE	NON-FERROUS METALS (ALUMINUM)	PLASTICS	CORIAN
HANDHELD CORDED	150mm	24T	20mm	WELDTEC	1897349	5	5	5	5	3	5	2	3	3	4	4	2	N/A	4	2
	150mm	30T	20mm	IRWIN®	1897090	4	4	2	4	2	4	1	2	2	3	3	1	N/A	3	1
	150mm	40T	20mm	WELDTEC	1897350	5	5	5	5	3	5	2	3	3	4	4	2	N/A	4	2
	160mm	18T	20mm	IRWIN®	1897191	4	4	2	4	2	4	N/A	2	2	3	3	1	N/A	3	1
				WELDTEC	1897361	5	5	5	5	3	5	2	3	3	4	4	2	N/A	4	2
	160mm	24T	30mm	IRWIN®	1907698	4	4	4	4	2	4	1	2	2	3	3	1	N/A	3	1
				WELDTEC	1897362	5	5	5	5	3	5	2	3	3	4	4	2	N/A	4	2
	160mm	30T	20mm	IRWIN®	1897192	4	4	2	4	2	4	1	2	2	3	3	1	N/A	3	1
	160mm	40T	20mm	WELDTEC	1897363	5	5	5	5	3	5	2	3	3	4	4	2	N/A	4	2
	165mm	18T	30mm	IRWIN®	1897193	4	4	2	4	2	4	N/A	2	2	3	3	1	N/A	3	1
				WELDTEC	1897364	5	5	5	5	3	5	2	3	3	4	4	2	N/A	4	2
	165mm	30T	30mm	IRWIN®	1897194	4	4	2	4	2	4	1	2	2	3	3	1	N/A	3	1
	165mm	40T	30mm	WELDTEC	1897366	5	5	5	5	3	5	2	3	3	4	4	2	N/A	4	2
	180mm	24T	30mm	IRWIN®	1897195	4	4	2	4	2	4	N/A	2	2	3	3	1	N/A	3	1
	180mm	36T	30mm	IRWIN®	1897196	4	4	2	4	2	4	1	2	2	3	3	1	N/A	3	1
	184mm	24T	16mm	IRWIN®	1907699	4	4	2	4	2	4	N/A	2	2	3	3	1	N/A	3	1
				WELDTEC	1897369	5	5	5	5	3	5	2	3	3	4	4	2	N/A	4	2
	184mm	24T	30mm	IRWIN®	1897197	4	4	2	4	2	4	N/A	2	2	3	3	1	N/A	3	1
				WELDTEC	1897368	5	5	5	5	3	5	2	3	3	4	4	2	N/A	4	2
	184mm	40T	16mm	WELDTEC	1897381	5	5	5	5	3	5	2	3	3	4	4	2	N/A	4	2
	184mm	40T	30mm	IRWIN®	1897198	4	4	2	4	2	4	1	2	2	3	3	1	N/A	3	1
				WELDTEC	1897370	5	5	5	5	3	5	2	3	3	4	4	2	N/A	4	2
	190mm	18T	30mm	WELDTEC	1897382	5	5	5	5	3	5	2	3	3	4	4	2	N/A	4	2
	190mm	24T	30mm	IRWIN®	1897199	4	4	2	4	2	4	1	2	2	3	3	1	N/A	3	1
				WELDTEC	1897383	5	5	5	5	3	5	2	3	3	4	4	2	N/A	4	2
	190mm	40T	30mm	IRWIN®	1897200	4	4	2	4	2	4	1	2	2	3	3	1	N/A	3	1
				WELDTEC	1897384	5	5	5	5	3	5	2	3	3	4	4	2	N/A	4	2
	200mm	24T	30mm	IRWIN®	1897201	4	4	2	4	2	4	N/A	2	2	3	3	1	N/A	3	1
	200mm	40T	30mm	IRWIN®	1897202	4	4	2	4	2	4	1	2	2	3	3	1	N/A	3	1
	210mm	20T	30mm	IRWIN®	1897203	4	4	2	4	2	4	N/A	2	2	3	3	1	N/A	3	1
	210mm	24T	30mm	WELDTEC	1897385	5	5	5	5	3	5	2	3	3	4	4	2	N/A	4	2
				IRWIN®	1897204	4	4	2	4	2	4	1	2	2	3	3	1	N/A	3	1
210mm	40T	30mm	WELDTEC	1897386	5	5	5	5	3	5	2	3	3	4	4	2	N/A	4	2	
235mm	20T	30mm	WELDTEC	1897387	5	5	5	5	3	5	2	3	3	4	4	2	N/A	4	2	
230mm	24T	30mm	IRWIN®	1897205	4	4	2	4	2	4	N/A	2	2	3	3	1	N/A	3	1	
			IRWIN®	1897206	4	4	2	4	2	4	1	2	2	3	3	1	N/A	3	1	
230mm	40T	30mm	WELDTEC	1897388	5	5	5	5	3	5	2	3	3	4	4	2	N/A	4	2	
235mm	40T	30mm	WELDTEC	1897389	5	5	5	5	3	5	2	3	3	4	4	2	N/A	4	2	
CORDLESS	136mm	18T	10mm	WELDTEC	1897390	5	5	5	5	3	5	2	3	3	4	4	2	N/A	4	2
	136mm	24T	10mm	WELDTEC	1897391	5	5	5	5	3	5	2	3	3	4	4	2	N/A	4	2
	165mm	18T	20mm	WELDTEC	1897392	5	5	5	5	3	5	2	3	3	4	4	2	N/A	4	2
	165mm	24T	20mm	WELDTEC	1897393	5	5	5	5	3	5	2	3	3	4	4	2	N/A	4	2
165mm	40T	20mm	WELDTEC	1897394	5	5	5	5	3	5	2	3	3	4	4	2	N/A	4	2	

RATING SCALE: (1=FAIR, 3=GOOD, 5=BEST)

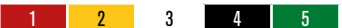

SELECTION CHART

		DIAMETER	TOOTH	BORE	BLADE	SKU	HARDWOODS	SOFTWOODS	MAIL EMBEDDED	PLYWOOD	LAMINATED PLYWOOD	PARTICLE BOARD	DELICATE MOULDING	LAMINATES	BILAMINATE PANELS (DOUBLE-SIDED LAMINATES)	CONGLOMERATES (COMPOSITES)	MDF	MELAMINE	NON-FERROUS METALS (ALUMINIUM)	PLASTICS	CORIAN	
STATIONARY	TABLE	235mm	20T	30mm	IRWIN®	1897207	4	4	2	4	2	4	N/A	2	2	3	3	1	N/A	3	1	
		235mm	40T	30mm	IRWIN®	1897208	4	4	2	4	2	4	1	2	2	3	3	1	N/A	3	1	
		250mm	24T	30mm	Construction	IRWIN®	1897210	4	4	2	4	2	4	N/A	2	2	3	3	1	N/A	3	3
						IRWIN®	1897448	5	5	2	5	2	5	2	5	2	4	4	1	N/A	3	3
		250mm	40T	30mm	Construction	IRWIN®	1897211	4	4	2	4	2	4	N/A	2	2	3	3	1	N/A	3	3
						IRWIN®	1897449	5	5	2	5	2	5	3	2	2	4	4	1	N/A	3	3
		250mm	60T	30mm	Construction	IRWIN®	1907700	3	3	1	3	1	3	3	1	1	3	3	N/A	N/A	2	2
						IRWIN®	1897450	4	4	2	4	2	4	4	2	2	4	4	1	N/A	3	3
		300mm	48T	30mm	Construction	IRWIN®	1897212	4	4	2	4	2	4	N/A	2	2	3	3	1	N/A	3	3
						IRWIN®	1897451	5	5	2	5	2	5	3	2	2	4	4	1	N/A	3	3
	300mm	60T	30mm	Construction	IRWIN®	1897213	4	4	2	4	2	4	N/A	2	2	3	3	1	N/A	3	3	
					IRWIN®	1897452	5	5	2	5	2	5	4	2	2	4	4	1	N/A	3	3	
	315mm	40T	30mm	IRWIN®	1897214	4	4	2	4	2	4	N/A	2	2	3	3	1	N/A	3	3		
	350mm	40T	30mm	IRWIN®	1897215	4	4	2	4	2	4	N/A	2	2	3	3	1	N/A	3	3		
	350mm	84T	30mm	IRWIN®	1897346	4	4	2	4	2	4	N/A	2	2	3	3	1	N/A	3	3		
	400mm	40T	30mm	IRWIN®	1897347	4	4	2	4	2	4	N/A	2	2	3	3	1	N/A	3	3		
	400mm	60T	30mm	IRWIN®	1897348	4	4	2	4	2	4	N/A	2	2	4	4	1	N/A	3	3		
	MITRE	216mm	24T	30mm	Construction	IRWIN®	1897395	5	5	1	5	3	4	1	3	2	4	4	2	N/A	4	2
						IRWIN®	1897209	4	4	2	4	2	3	1	2	3	3	1	N/A	3	1	
		216mm	48T	30mm	Construction	IRWIN®	1897396	5	5	1	5	3	4	3	3	2	4	4	2	N/A	4	2
IRWIN®						1897397	5	5	1	5	3	4	4	3	2	4	4	2	N/A	4	2	
250mm		48T	30mm	Construction	1897398	5	5	1	5	3	4	2	3	2	4	4	2	N/A	4	2		
250mm		60T	30mm	Construction	1897426	5	5	1	5	3	4	3	3	2	4	4	2	N/A	4	2		
250mm		80T	30mm	Construction	1897427	5	5	1	5	3	4	4	3	2	4	4	2	N/A	4	2		
254mm		48T	30mm	Construction	1897428	5	5	1	5	3	4	2	3	2	4	4	2	N/A	4	2		
254mm		60T	30mm	Construction	1897429	5	5	1	5	3	4	3	3	2	4	4	2	N/A	4	2		
254mm		80T	30mm	Construction	1897430	5	5	1	5	3	4	4	3	2	4	4	2	N/A	4	2		
260mm		48T	30mm	Construction	1897431	5	5	1	5	3	4	2	3	2	4	4	2	N/A	4	2		
260mm		60T	30mm	Construction	1897432	5	5	1	5	3	4	3	3	2	4	4	2	N/A	4	2		
260mm		80T	30mm	Construction	1897433	5	5	1	5	3	4	4	3	2	4	4	2	N/A	4	2		
305mm		48T	30mm	Construction	1897434	5	5	1	5	3	4	2	3	2	4	4	2	N/A	4	2		
305mm		60T	30mm	Construction	1897435	5	5	1	5	3	4	3	3	2	4	4	2	N/A	4	2		
305mm	96T	30mm	Construction	1897436	5	5	1	5	3	4	4	3	2	4	4	2	N/A	4	2			

CIRCULAR SAW BLADES

SELECTION CHART

		DIAMETER	TOOTH	BORE	BLADE	SKU	HARDWOODS	SOFTWOODS	NAIL EMBEDDED	PLYWOOD	LAMINATED PLYWOOD	PARTICLE BOARD	DELICATE MOULDING	LAMINATES	BILAMINATE PANELS (DOUBLE-SIDED LAMINATES)	CONGLOMERATES (COMPOSITES)	MDF	MELAMINE	NON-FERROUS METALS (ALUMINIUM)	PLASTICS	CORIAN		
STATIONARY	MULTI	160mm	48T	20mm	Construction	1897437	4	3	2	3	4	3	5	5	4	4	4	5	4	4	5		
		165mm	48T	30mm	Construction	1897438	4	3	2	3	4	3	5	5	4	4	4	5	4	4	5		
		184mm	48T	30mm	Construction	1897439	4	3	2	3	4	3	5	5	4	4	4	5	4	4	5		
		190mm	48T	30mm	Construction	1897440	4	3	2	3	4	3	5	5	4	4	4	5	4	4	5		
		210mm	60T	30mm	Construction	1897441	4	3	2	3	4	3	5	5	4	4	4	5	4	4	5		
		216mm	84T	30mm	Construction	1897442	4	3	2	3	4	3	5	5	4	4	4	5	4	4	5		
		250mm	84T	30mm	Construction	1897443	4	3	2	3	4	3	5	5	4	4	4	5	4	4	5		
		254mm	84T	30mm	Construction	1897444	4	3	2	3	4	3	5	5	4	4	4	5	4	4	5		
		260mm	84T	30mm	Construction	1897445	4	3	2	3	4	3	5	5	4	4	4	5	4	4	5		
		300mm	96T	30mm	Construction	1897446	4	3	2	3	4	3	5	5	4	4	4	5	4	4	5		
		305mm	84T	30mm	Construction	1897447	4	3	2	3	4	3	5	5	4	4	4	5	4	4	5		
MATERIAL SPECIFIC	ALUMINIUM	160mm	56T	20mm	IRWIN®	1907772	N/A	N/A	N/A	N/A	N/A	N/A	N/A	N/A	N/A	N/A	N/A	N/A	5	N/A	N/A		
		184mm	48T	30mm	IRWIN®	1907773	N/A	N/A	N/A	N/A	N/A	N/A	N/A	N/A	N/A	N/A	N/A	N/A	N/A	5	N/A	N/A	
		200mm	60T	30mm	IRWIN®	1907774	N/A	N/A	N/A	N/A	N/A	N/A	N/A	N/A	N/A	N/A	N/A	N/A	N/A	5	N/A	N/A	
		210mm	60T	30mm	IRWIN®	1907775	N/A	N/A	N/A	N/A	N/A	N/A	N/A	N/A	N/A	N/A	N/A	N/A	N/A	N/A	5	N/A	N/A
		216mm	60T	30mm	IRWIN®	1907777	N/A	N/A	N/A	N/A	N/A	N/A	N/A	N/A	N/A	N/A	N/A	N/A	N/A	N/A	5	N/A	N/A
		250mm	80T	30mm	IRWIN®	1907778	N/A	N/A	N/A	N/A	N/A	N/A	N/A	N/A	N/A	N/A	N/A	N/A	N/A	N/A	5	N/A	N/A
		250mm	100T	30mm	IRWIN®	1907779	N/A	N/A	N/A	N/A	N/A	N/A	N/A	N/A	N/A	N/A	N/A	N/A	N/A	N/A	5	N/A	N/A
		300mm	96T	30mm	IRWIN®	1907781	N/A	N/A	N/A	N/A	N/A	N/A	N/A	N/A	N/A	N/A	N/A	N/A	N/A	N/A	5	N/A	N/A
		250mm	84T	30mm	IRWIN®	1907782	N/A	N/A	N/A	N/A	N/A	N/A	N/A	N/A	N/A	N/A	N/A	N/A	N/A	N/A	5	N/A	N/A

RATING SCALE: (1=FAIR, 3=GOOD, 5=BEST)

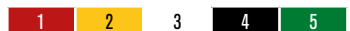



BI-METAL HOLE SAWS

LONG ESTABLISHED MANUFACTURING EXCELLENCE LEADS TO PERFECTION

IRWIN® manufactures and distributes high quality cutting tools for trade professionals who demand superior performance and durability on the job. Our engineers have been working for almost over a century on constant product improvement, resulting in a state-of-the-art in-house electron beam welding process to create the highest quality bi-metal blades that out-perform the competition, stay sharper and last longer.

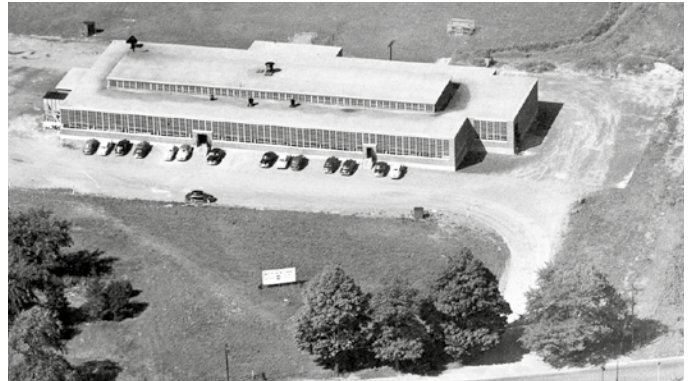

The WeldTec™ platform combines various attributes to deliver long lasting cutting performance. A revolutionary tooth geometry and an updated tooth set enables faster and smoother cuts, as well as improved longevity.

HOLE SAWS



RECIPROCATING BLADES



JIGSAW BLADES



BI-METAL HOLE SAWS

IRWIN® Bi-Metal Hole Saws cut through a variety of materials, including: Aluminium, Copper, Iron, Stainless Steel, Wood and Zinc.

The electron beam welded High Speed Steel (HSS) cutting edge ensures stronger, longer lasting teeth. Precision set teeth provide faster penetration and cutting. And, the bi-metal construction delivers toughness and long life.

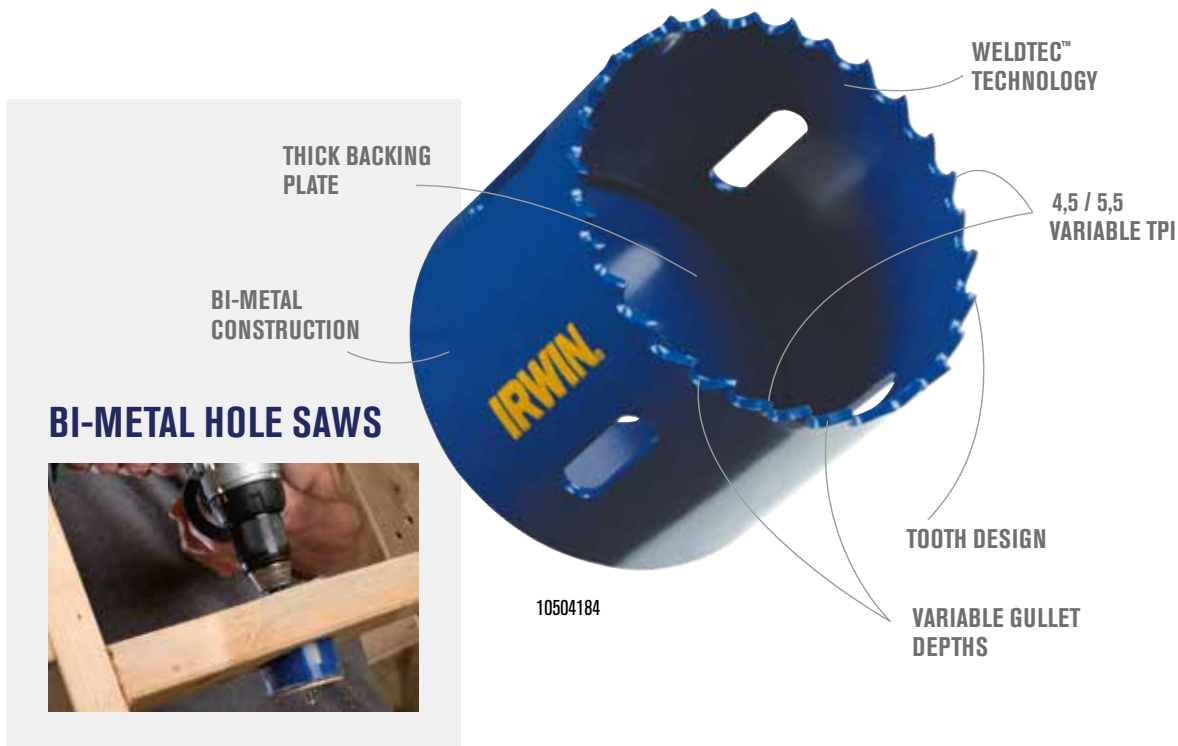

BI-METAL HOLE SAWS



- 1. WELDTEC™ TECHNOLOGY**
Delivers enhanced durability and higher cutting speed
- 2. TOOTH DESIGN**
For up to 100% longer life and 50% faster cutting*
- 3. 4,5 / 5,5 VARIABLE TPI**
For faster cuts, less torque build-up and enhanced chip removal
- 4. VARIABLE GULLET DEPTHS**
For more efficient chip clearance
- 5. THICK BACKING PLATE**
Gives robustness for the toughest jobs
- 6. BI-METAL CONSTRUCTION**
For increased life and durability

*vs. previous model

ITEM NO.	HOLE SAW DIAMETER	EAN	MASTER PACK	SHELF PACK
10504161	Ø 14mm	5706915041613	160	1
10504162	Ø 16mm	5706915041620	160	1
10504163	Ø 17mm	5706915041637	160	1
10504164	Ø 19mm	5706915041644	160	1
10504165	Ø 20mm	5706915041651	160	1
10504166	Ø 21mm	5706915041668	160	1
10504167	Ø 22mm	5706915041675	160	1
10504168	Ø 24mm	5706915041682	160	1
10504169	Ø 25mm	5706915041699	160	1
10504170	Ø 27mm	5706915041705	160	1
10504171	Ø 29mm	5706915041712	160	1
10504172	Ø 30mm	5706915041729	160	1
10504173	Ø 32mm	5706915041736	120	1
10504174	Ø 33mm	5706915041743	120	1
10504175	Ø 35mm	5706915041750	120	1
10504176	Ø 37mm	5706915041767	120	1
10504177	Ø 38mm	5706915041774	120	1
10504178	Ø 40mm	5706915041781	120	1
10504179	Ø 41mm	5706915041798	120	1
10504180	Ø 43mm	5706915041804	120	1
10504181	Ø 44mm	5706915041811	120	1

BI-METAL HOLE SAWS

BI-METAL HOLE SAWS

ITEM NO.	HOLE SAW DIAMETER	EAN	MASTER PACK	SHELF PACK
10504182	Ø 46mm	5706915041828	120	1
10504183	Ø 48mm	5706915041835	100	1
10504184	Ø 51mm	5706915041842	100	1
10504185	Ø 52mm	5706915041859	100	1
10504186	Ø 54mm	5706915041866	100	1
10507366	Ø 56mm	5706915073669	100	1
10504187	Ø 57mm	5706915041873	100	1
10504188	Ø 59mm	5706915041880	100	1
10504189	Ø 60mm	5706915041897	100	1
10507367	Ø 62mm	5706915073676	100	1
10504190	Ø 64mm	5706915041903	50	1
10504191	Ø 65mm	5706915041910	50	1
10504192	Ø 67mm	5706915041927	50	1
10504193	Ø 68mm	5706915041934	50	1
10504194	Ø 70mm	5706915041941	50	1
10504195	Ø 73mm	5706915041958	50	1
10504196	Ø 76mm	5706915041965	50	1
10504197	Ø 79mm	5706915041972	50	1
10504198	Ø 83mm	5706915041989	50	1
10504199	Ø 86mm	5706915041996	50	1
10504200	Ø 89mm	5706915042009	50	1
10504201	Ø 92mm	5706915042016	40	1
10504202	Ø 95mm	5706915042023	40	1
10504203	Ø 98mm	5706915042030	40	1
10504204	Ø 102mm	5706915042047	40	1
10504205	Ø 105mm	5706915042054	40	1
10504206	Ø 108mm	5706915042061	40	1
10504207	Ø 111mm	5706915042078	40	1
10504208	Ø 114mm	5706915042085	40	1
10504209	Ø 117mm	5706915042092	20	1
10504210	Ø 121mm	5706915042108	20	1
10504211	Ø 127mm	5706915042115	20	1
10505818	Ø 133mm	5706915058185	20	1
10504212	Ø 140mm	5706915042122	20	1
10504213	Ø 152mm	5706915042139	20	1
10505819	Ø 168mm	5706915058192	20	1
10505820	Ø 177mm	5706915058208	20	1
10505821	Ø 210mm	5706915058215	20	1



10504184

ARBORS / PILOT DRILL BITS FOR BI-METAL HOLE SAW KITS

ITEM NO.	DESCRIPTION	EAN	MASTER PACK	SHELF PACK
10504532	Pilot Drill	5706915945324	20	1
10504536	Arbor (Mandrel) 9,5mm chuck diameter, fits Hole Saws 14 - 30mm	5706915945362	20	1
10504533	Arbor (Mandrel) 13mm chuck diameter, fits Hole Saws 14 - 30mm	5706915945331	20	1
10504534	Arbor (Mandrel) 9,5mm chuck diameter, fits Hole Saws 32 - 210mm	5706915945348	20	1
10504535	Arbor (Mandrel) 13mm chuck diameter, fits Hole Saws 32 - 210mm	5706915945355	20	1
10507368	Extension Rod, 300mm, Chuck size 13+mm	5706915073683	20	1



10504535

BI-METAL HOLE SAW KITS

IRWIN® Hole Saw Kits are available in a unique attractive soft storage case that incorporates an unbreakable hinge and internal padding that protects the contents. The case has an integrated handle and has a cardboard sleeve that contains important product information.

ITEM NO.	DESCRIPTION	EAN	MASTER PACK	SHELF PACK
10507235	Hole Saw Kit 400SE: 22, 35, 65, 67mm, Arbors 10504535 & 10504536, Pilot drill	5706915072358	144	1
10506439	Hole Saw Kit 600L: 22, 29, 35, 44, 51, 64mm, Arbors 10504535 & 10504536, Pilot drill	5706915064391	144	1
10506440	Hole Saw Kit 600L SE: 22, 29, 35, 44, 51, 65mm, Arbors 10504535 & 10504536, Pilot drill	5706915064407	144	1
10506441	Hole Saw Kit INT600L: 16, 20, 25, 32, 38, 51mm, Arbors 10504535 & 10504536, Pilot drill	5706915064414	144	1
10506442	Hole Saw Kit 600P: 19, 22, 29, 38, 44, 57mm, Arbors 10504535 & 10504536, Pilot drill	5706915064421	144	1
10506444	Hole Saw Kit 1200G: 16, 19, 22, 25, 29, 32, 35, 38, 44, 51, 64, 76mm, Arbors 10504533 & 10504535, 3 Pilot drills	5706915064445	96	1
10506445	Hole Saw Kit 1200G SE: 16, 19, 22, 25, 29, 32, 35, 38, 44, 51, 65, 76mm, Arbors 10504533 & 10504535, 3 Pilot drills	5706915064452	96	1



10507235



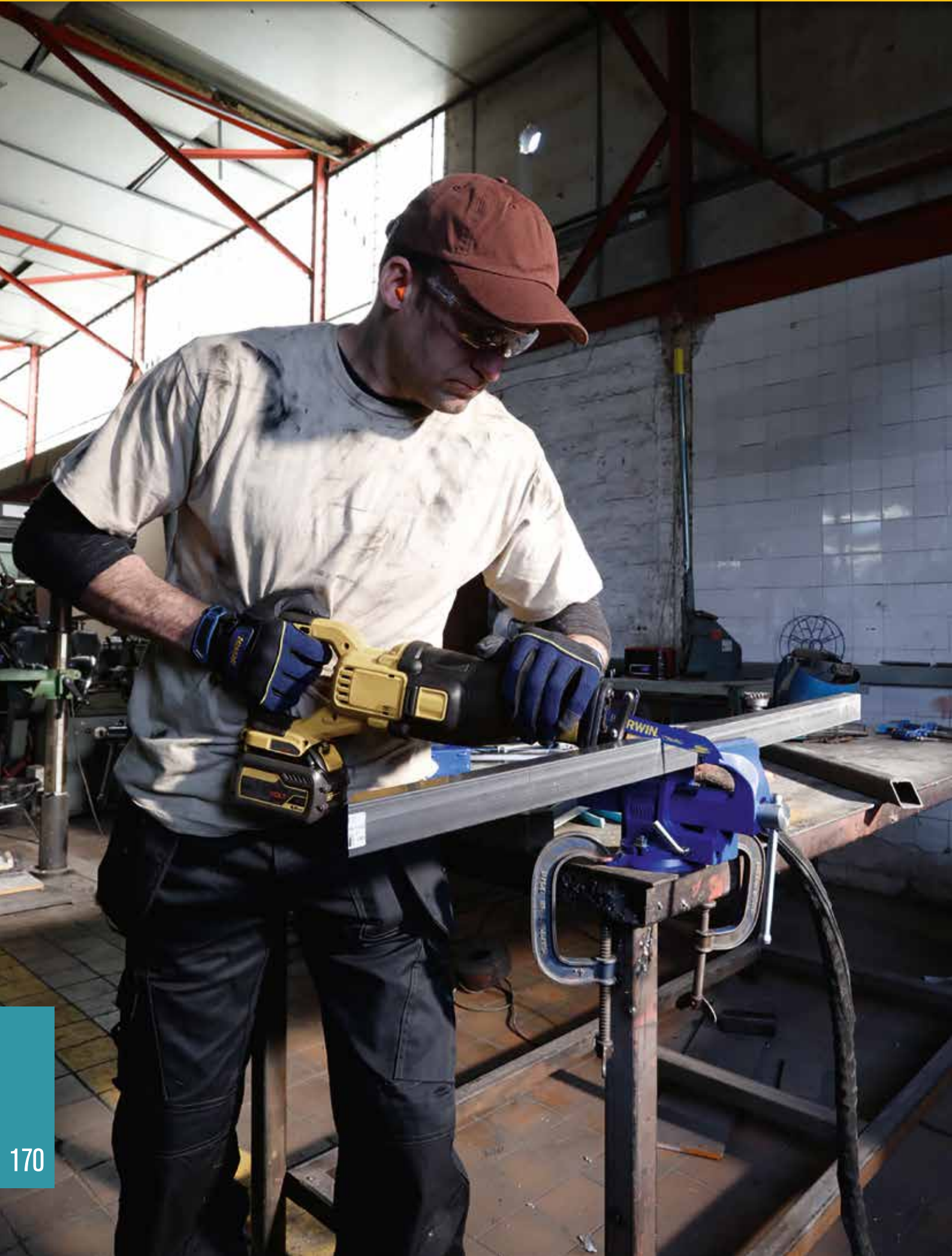

BI-METAL RECIPROCATING BLADES

This comprehensive reciprocating saw blade offering has a blade for every application. IRWIN® blades offer superior construction and design making them faster cutting and longer lasting, therefore giving the user a superior cost-per-cut value.

BI-METAL RECIPROCATING SAW BLADES

- 1. INCREASED TANG ANGLE**
For up to 50% faster cuts vs. previous model
- 2. BI-METAL CONSTRUCTION**
For a faster cutting, longer lasting blade that can bend without breaking
- 3. WELDTEC™ TECHNOLOGY**
For stronger, longer lasting teeth
- 4. 8% COBALT**
Keeps teeth sharper, longer
- 5. IMPROVED TOOTH CONFIGURATION**
For up to 100% longer life and 50% faster cutting*

LONG-LASTING
BiMetal
TECHNOLOGY

WITH **WELDTEC™**

METAL CUTTING BI-METAL RECIPROCATING SAW BLADES

ITEM NO.	DESCRIPTION	BLADES PER PACK	EAN	MASTER PACK	SHELF PACK
10506424	614R 6" / 150mm 14TPI, Metal Cutting	2	5706915064247	150	1
10506425	624R 6" / 150mm 24TPI, Metal Cutting	2	5706915064254	150	1
10506426	818R 8" / 200mm 18TPI, Metal Cutting	2	5706915064261	90	1
10504147	414R 4" / 100mm 14TPI, Metal Cutting	5	5706915041477	100	1
10504148	418R 4" / 100mm 18TPI, Metal Cutting	5	5706915041484	100	1
10504152	614R 6" / 150mm 14TPI, Metal Cutting	5	5706915041521	100	1
10504153	618R 6" / 150mm 18TPI, Metal Cutting	5	5706915041538	100	1
10504154	624R 6" / 150mm 24TPI, Metal Cutting	5	5706915041545	100	1
10504156	818R 8" / 200mm 18TPI, Metal Cutting	5	5706915041569	50	1
10504143	614R 6" / 150mm 14TPI, Metal Cutting	25	5706915041439	20	1
10504140	818R 8" / 200mm 18TPI, Metal Cutting	25	5706915041408	10	1

CUTS ALL METALS including non ferrous, pipe conduit, stainless & sheet metal

SUITABLE for use with materials 1.5 to 10mm (1/16" to 3/8") thick, dependent on the TPI of the blade

AVAILABLE IN 10, 14, 18 and 24TPI on metal cutting reciprocating saw blades



METAL & WOOD CUTTING BI-METAL RECIPROCATING BLADES



CUTS COMPOSITION MATERIALS such as plastic, wood, pipe, carbon steel & stainless steel

SUITABLE for use with materials 3.2mm (1/8") & thicker

AVAILABLE IN 10 TPI in 150, 200 & 300mm (6", 8" & 12") sizes

ITEM NO.	DESCRIPTION	BLADES PER PACK	EAN	MASTER PACK	SHELF PACK
10506427	610R 6" / 150mm 10TPI, Metal & Wood Cutting	2	5706915064278	150	1
10506428	810R 8" / 200mm 10TPI, Metal & Wood Cutting	2	5706915064285	90	1
10504151	610R 6" / 150mm 10TPI, Metal & Wood Cutting	5	5706915041514	100	1
10504157	810R 8" / 200mm 10TPI, Metal & Wood Cutting	5	5706915041576	50	1
10504159	110R 12" / 300mm 10/14TPI, Metal & Wood Cutting	5	5706915041590	50	1
10504141	810R 8" / 200mm 10TPI, Metal & Wood Cutting	25	5706915041415	10	1
10504142	110R 12" / 300mm 10/14TPI, Metal & Wood Cutting	25	5706915041422	25	1

NAIL-EMBEDDED BI-METAL RECIPROCATING BLADES



CUTS NAIL EMBEDDED WOOD

SUITABLE for use with materials 5mm (3/16") & thicker

AVAILABLE IN 6TPI in 150, 225 & 300mm (6", 9" & 12") sizes

ITEM NO.	DESCRIPTION	BLADES PER PACK	EAN	MASTER PACK	SHELF PACK
10506429	656R 6" / 150mm 6TPI, Nail-Embedded Wood Cutting	2	5706915064292	150	1
10506430	956R 9" / 225mm 6TPI, Nail-Embedded Wood Cutting	2	5706915064308	90	1
10504155	656R 6" / 150mm 6TPI, Nail-Embedded Wood Cutting	5	5706915041552	100	1
10504158	956R 9" / 225mm 6TPI, Nail-Embedded Wood Cutting	5	5706915041583	50	1
10504160	156R 12" / 300mm 6TPI, Nail-Embedded Wood Cutting	5	5706915041606	50	1
10504146	656R 6" / 150mm 6TPI, Nail-Embedded Wood Cutting	25	5706915041460	20	1
10504149	956R 9" / 225mm 6TPI, Nail-Embedded Wood Cutting	25	5706915041491	10	1
10504144	156R 12" / 300mm 6TPI, Nail-Embedded Wood Cutting	25	5706915041446	10	1

DEMOLITION BI-METAL RECIPROCATING BLADES



HEAVY-DUTY & DEMOLITION applications in wood & metal

SUITABLE for use with materials 5mm (3/16") & thicker

AVAILABLE IN 6 or 10 TPI in 225mm (9")

ITEM NO.	DESCRIPTION	BLADES PER PACK	EAN	MASTER PACK	SHELF PACK
10504138	966R 9" / 225mm 6TPI, Demolition Applications	5	5706915041385	50	1
10504139	960R 9" / 225mm 10TPI, Demolition Applications	5	5706915041392	50	1

WOOD CUTTING BI-METAL RECIPROCATING BLADES



FAST CUTTING in wood

SUITABLE for use with materials 5mm (3/16") & thicker

AVAILABLE IN 6 TPI in 150mm (6")

ITEM NO.	DESCRIPTION	BLADES PER PACK	EAN	MASTER PACK	SHELF PACK
10504150	606R 6" / 150mm 6TPI, Wood Cutting	5	5706915041507	100	1

RECIPROCATING SAW BLADES

MASTER-GRIT RECIPROCATING BLADES



ITEM NO.	DESCRIPTION	BLADES PER PACK	EAN	MASTER PACK	SHELF PACK
10507365	80ORG 8" / 200mm Carbide Grit	2	5706915073652	80	1

CARBIDE GRIT EDGE MATERIAL for smooth, quick cuts

CUTS ABRASIVE MATERIALS including cast iron, fibreglass, plaster and marble

WOOD PRUNING RECIPROCATING BLADES

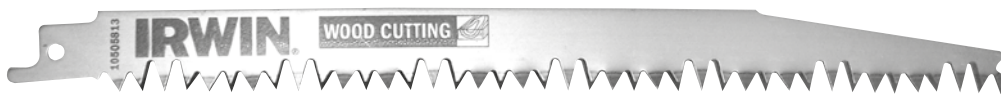

ITEM NO.	DESCRIPTION	BLADES PER PACK	EAN	MASTER PACK	SHELF PACK
IW1016914	225mm, Wood Pruning	2	5054905250195	1	1

MASONRY RECIPROCATING BLADES



ITEM NO.	DESCRIPTION	BLADES PER PACK	EAN	MASTER PACK	SHELF PACK
10507846	MRB 235 x 20mm 2,5TPI, Masonry Cutting	-	5706915078466	25	1
10507847	MRB 300 x 50mm 2,5TPI, Masonry Cutting	-	5706915078473	25	1
10507848	MRB 450 x 50mm 2,5TPI, Masonry Cutting	-	5706915078480	25	1

FAST, DURABLE AND PRECISE CUTTING in many masonry materials like clay bricks, limestone or gas concrete.

UNIVERSAL 1/2" SHANK

MIXED RECIPROCATING BLADES SET

ITEM NO.	DESCRIPTION	BLADES PER PACK	EAN	MASTER PACK	SHELF PACK
IW1016915	3 x Nail-Embedded 656R, 6TPI x 150mm/1 x Nail-Embedded 956R, 6TPI x 228mm 3 x Metal Cutting 624R, 24TPI x 150mm/2 x Metal Cutting 810R, 10TPI x 203mm 2 x Metal Cutting 818R, 18TPI x 203mm	11	5054905250201	1	1

ITEM NO.	DESCRIPTION	BLADES PER PACK	EAN	MASTER PACK	SHELF PACK
IW1016901	Multi-Saw incl wood and hacksaw	-	5050905239480	1	1



JIGSAW BLADES

This comprehensive jigsaw blade offering has a blade for every application. The range includes both T-shank and U-shank to fit all of today's most popular jigsaw machines.

IRWIN® Jigsaw Blades are manufactured from the following high quality materials:

HCS Carbon steel for use in softer materials such as wood, laminated chipboard, and plastics.

HSS Fully hardened high-speed steel for use in metal, aluminium, and non-ferrous metal.

WOOD CUTTING HCS JIGSAW BLADES - T-SHANK



3-SIDED, FLEAM GROUND TEETH for fast cut and clean finishes

FAST AND SMOOTH CUTS in all wood applications

ITEM NO.	DESCRIPTION	BLADES PER PACK	EAN	MASTER PACK	SHELF PACK
10504218	HCS, 100mm, 6 TPI, T144D, Standard, Wood Cutting	5	5706915042184	100	1
10504219	HCS, 100mm, 10 TPI, T101B, Side Ground, Wood Cutting	5	5706915042191	100	1
10504221	HCS, 100mm, 8 TPI, T111C, Standard, Wood Cutting	5	5706915042214	100	1
10504222	HCS, 100mm, 6 TPI, T101D, Side Ground, Wood Cutting	5	5706915042221	100	1
10504223	HCS, 100mm, 10 TPI, T101BR, Side Ground Reverse, Wood Cutting	5	5706915042238	100	1
10504224	HCS, 100mm, 6 TPI, T244D, Standard Contour, Wood Cutting	5	5706915042245	100	1
10504226	HCS, 83mm, 20 TPI, T101A0, Side Ground Narrow Contour, Wood Cutting	5	5706915042269	100	1
10504227	HCS, 83mm, 12 TPI, T119B0, Standard Narrow Contour, Wood Cutting	5	5706915042276	100	1
10504228	HCS, 115mm, Progressive 8-13TPI, T234X, Side Ground, Wood Cutting	5	5706915042283	100	1
10504229	HCS, 115mm, 8 TPI, T301CD, Side Ground, Wood Cutting	5	5706915042290	100	1
10504410	HCS, 100mm, 6 TPI, T144DP, Standard Extra Thick 1.68mm, Wood Cutting	5	5706915044102	100	1
10504545	HCS, 100mm, 6 TPI, T144D, Standard, Wood Cutting	100	5706915945454	10	1

METAL CUTTING HSS JIGSAW BLADES - T-SHANK



HSS MILLED TEETH for longer life and fast cuts in metal

EXTENDED LIFE for fast and even cuts in thin and thick metal

ITEM NO.	DESCRIPTION	BLADES PER PACK	EAN	MASTER PACK	SHELF PACK
10504220	HSS, 92mm, Progressive 17-23TPI, T118A, Metal Cutting	5	5706915042207	100	1
10504225	HSS, 92mm, Progressive 11-13TPI, T118B, Metal Cutting	5	5706915042252	100	1
10504234	HSS, 92mm, 36 TPI, T118G, Metal Cutting	5	5706915042344	100	1
10504231	HSS, 100mm, 8 TPI, T127D, Metal Cutting	5	5706915042313	100	1
10504233	HSS, 100mm, Progressive 10-20TPI, T123X, Metal Cutting	5	5706915042337	100	1
10504230	HSS, 132mm, 24 TPI, T318A, Metal Cutting	5	5706915042306	100	1

METAL & WOOD CUTTING BI-METAL JIGSAW BLADES - T-SHANK



PROGRESSIVE TOOTH FORM for all-purpose cutting in wood and metal

BI-METAL CONSTRUCTION for extended life in wood and metal

ITEM NO.	DESCRIPTION	BLADES PER PACK	EAN	MASTER PACK	SHELF PACK
10504232	BIM, 132mm, Progressive 5-10TPI, T345XF, Metal & Wood Cutting	5	5706915042320	100	1

FIBER & PLASTER CARBIDE TIPPED JIGSAW BLADES - T-SHANK



ITEM NO.	DESCRIPTION	BLADES PER PACK	EAN	MASTER PACK	SHELF PACK
10505815	T141HM Carbide Tipped, 100mm, 6TPI, Fiber & Plastic Cutting	1	5706915058154	100	1
10505816	T341HM Carbide Tipped, 132mm, 6TPI	1	5706915058161	100	1

CARBIDE TIPPED for long lifetime, especially for abrasive materials

METAL & WOOD CUTTING JIGSAW BLADE SETS - T-SHANK

ITEM NO.	DESCRIPTION	BLADES PER PACK	EAN	MASTER PACK	SHELF PACK
10505817	Jigsaw Set T-Shank: 2 x 10504221 Wood, 100mm, 8 TPI 2 x 10504218 Wood, 100mm, 6 TPI (fast cut) 2 x 10504219 Wood, 100mm, 10 TPI 1 x 10504222 Wood, 100mm, 6 TPI (clean cut) 2 x 10504220 Metal, 92mm, Progressive 17 - 23 TPI 1 x 10504225 Metal, 92mm, Progressive 11 - 13 TPI	10	5706915058178	50	1



WOOD CUTTING HCS JIGSAW BLADES - U-SHANK



ITEM NO.	DESCRIPTION	BLADES PER PACK	EAN	MASTER PACK	SHELF PACK
10504235	HCS, 100mm, 6 TPI, U144D, Standard, Wood Cutting	5	5706915042351	100	1
10504288	HCS, 100mm, 10 TPI, U101B, Side Ground, Wood Cutting	5	5706915042887	100	1
10504290	HCS, 100mm, 8 TPI, U111C, Standard, Wood Cutting	5	5706915042900	100	1
10504291	HCS, 100mm, 6 TPI, U101D, Side Ground, Wood Cutting	5	5706915042917	100	1
10504292	HCS, 100mm, 6 TPI, U244D, Standard Contour, Wood Cutting	5	5706915042924	100	1
10504295	HCS, 115mm, Progressive 8-13TPI, U234X, Side Ground, Wood Cutting	5	5706915042955	100	1

3-SIDED, FLEAM GROUND TEETH for fast cut and clean finishes
FAST AND SMOOTH CUTS in all wood applications

METAL CUTTING HSS JIGSAW BLADES - U-SHANK



ITEM NO.	DESCRIPTION	BLADES PER PACK	EAN	MASTER PACK	SHELF PACK
10504289	HSS, 70mm, 24 TPI, U118A, Metal Cutting	5	5706915042894	100	1
10504293	HSS, 70mm, 12 TPI, U118B, Metal Cutting	5	5706915042931	100	1
10504294	HSS, 70mm, 36 TPI, U118G, Metal Cutting	5	5706915042948	100	1
10504297	HSS, 100mm, Progressive 10-20TPI, U123X, Metal Cutting	5	5706915042979	100	1

HSS MILLED TEETH for longer life and fast cuts in metal
EXTENDED LIFE for fast and even cuts in thin and thick metal

METAL & WOOD CUTTING BI-METAL JIGSAW BLADES - U-SHANK



ITEM NO.	DESCRIPTION	BLADES PER PACK	EAN	MASTER PACK	SHELF PACK
10504296	BIM, 132mm, Progressive 5-10TPI, U345XF, Metal & Wood Cutting	5	5706915042962	100	1



PROGRESSIVE TOOTH FORM for all-purpose cutting in wood and metal
BI-METAL CONSTRUCTION for extended life in wood and metal

IRWIN®

Stanley Black & Decker Austria GmbH
Oberlaaer Strasse 248
1230 Wien
Austria
Tel: +4313602774562

Stanley Black & Decker Belgium BVBA
Egide Walschaertsstraat 16
2800 Mechelen
Belgium
Tel. 015 47 37 65
Fax 015 47 37 99
E-mail customer.service.bnl@sbdinc.com

Stanley Black & Decker Czech Republic s.r.o.
Türkova 2319/5B,
Chodov
14900 Praha 4, PSC
Czech Republic
Tel: +48616279410

Stanley Black & Decker, Dansk filial af Black & Decker (Overseas) GmbH, Liechtenstein
Roskildevej 22
2620 Albertslund
Denmark
Tel: +45 70 20 15 10

Stanley Black & Decker OY
Elimäenkatu 30 D, 5. Krs
00520 Helsinki
Finland
Tel: +358 10 400 4333

Stanley Black & Decker France SAS
5, Allée des Hêtres
69760 Limonest Cedex
France
Tel: 0164544009

Stanley Black & Decker Deutschland GmbH
Black & Decker Strasse 40
D65510 Idstein
Germany
Tel: +496126212109

Stanley Black & Decker Hungary Korlátolt Felelősségű Társaság
Mészáros utca 58/B
1016 Budapest
Hungary
Tel: +48616279424

Stanley Black & Decker Italia S.r.l.
Via Energy Park n. 6
20871 Vimercate (Mb)
Italy
Tel: +390399590220

Stanley Black & Decker Netherlands B.V.
Holtum Noordweg 35
6121 RE, Born
Netherlands
Tel: +31 164 28 30 65
Fax +31 164 28 32 00
E-mail customer.service.bnl@sbdinc.com

Stanley Black & Decker Norway AS
Gullhaugveien 11
0484 Oslo
Norway
Tel: +47 22 90 99 10

Stanley Black & Decker Polska Sp. z o.o.
ul. Prosta 68
00-838 Warsaw
Poland
Tel: +48616279418

Stanley Black & Decker Holdings S.Á.R.L. Sucursal em Portugal
Quinta da Fonte - Edifício Q55 D.
Diniz, Rua dos Malhões,
2 e 2A - Piso 2 Esquerdo
2710-071 Paço D'Arcos
Portugal
Tel: +351210609323

Stanley Black & Decker Ibérica, S.L.
Edificio Muntadas
C/Berguedà 1, Of. A6
08820 El Prat de Llobregat
Barcelona
Tel: +34934797419

Stanley Black & Decker Sweden AB
Flöjelbergsg. 1c
SE 431 22 Mölndal
Sweden
Tel: +46(0) 31 68 60 60

Stanley Works (Europe) GmbH
In der Luberzen 42
8902 Urdorf
Switzerland
Tel: +48616279424

Stanley Black & Decker, INC.
Level 2, 810 Whitehorse Road,
Box Hill, VIC
Australia, 3128
Tel: 1800 331 491

Stanley Black & Decker NZ Limited
39 Business Parade N, East Tamaki
Auckland 2013
New Zealand
Tel: 0800 352 682

Stanley Black & Decker UK Limited
270 Bath Road
SL1 4DX Slough
United Kingdom
Tel: +441753500517

X-ON Electronics

Largest Supplier of Electrical and Electronic Components

Click to view similar products for [Tool Kits & Cases](#) category:

Click to view products by [Irwin](#) manufacturer:

Other Similar products are found below :

[1547919](#) [11-18-3023](#) [63902-3270](#) [63860-8170](#) [2220](#) [856600-2](#) [11-40-3247](#) [63883-2870](#) [63901-5670](#) [63866-1070](#) [63863-5070](#) [63892-7370](#)
[11-18-3209](#) [63860-4070](#) [63881-0970](#) [11-18-3040](#) [63865-2070](#) [63910-1470](#) [63861-5070](#) [63850-7470](#) [11-18-3201](#) [63910-7570](#) [63883-0670](#)
[63830-0070](#) [63902-9170](#) [11-18-3147](#) [11-18-3079](#) [63883-2670](#) [63900-1770](#) [11-18-3190](#) [63912-4770](#) [63911-5270](#) [63895-1070](#) [63860-1470](#)
[63850-6070](#) [1-69411-3](#) [63852-9270](#) [11-18-3202](#) [63852-9170](#) [63850-1070](#) [63830-0170](#) [63910-2870](#) [11-18-3010](#) [63820-7070](#) [63851-7170](#)
[63865-6170](#) [63900-4770](#) [63860-3070](#) [11-18-3082](#) [63911-2870](#)