



ICPL0630, ICPL0631

DESCRIPTION

The ICPL0630 and ICPL0631 dual channel devices each consists of an infrared emitting diode optically coupled to a high speed photo detector transistor.

These devices belong to Isocom Compact Range of optocouplers.

FEATURES

- High speed 10Mbit/s
- Half Pitch 1.27mm
- 10kV/ μ s min. Common Mode Transient Immunity (ICPL0631)
- High AC Isolation Voltage 3750V_{RMS}
- Guaranteed Performance from -40°C to 85°C
- Wide Operating Temperature Range
- -40°C to 100°C
- Pb Free and RoHS Compliant
- Halogen Free
- Safety Approvals Pending

APPLICATIONS

- Line Receivers, Data Communication
- LSTTL to TTL, LSTTL or 5V CMOS
- Data Multiplexing
- Pulse Transformer Replacement
- Switch Mode Power Supplies
- Ground Loop Elimination
- Computer Peripheral Interface

ORDER INFORMATION

- Available in Tape and Reel with 2000pcs per reel.

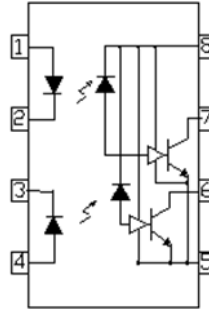

1. Anode (Channel1)
2. Cathode (Channel 1)
3. Cathode (Channel 2)
4. Anode (Channel 2)
5. GND
6. Vout 2
7. Vout 1
8. Vcc

A 0.1 μ F bypass capacitor must be connected between Vcc (pins 8) and GND (pin 5).

ABSOLUTE MAXIMUM RATINGS (T_A = 25°C)

Input Diode

Forward Current	20mA
Reverse Voltage	5V
Power dissipation	45mW

Output

Output Current	50mA
Output Voltage	7V
Supply Voltage (max 1 min)	7V
Power Dissipation	60mW

Total Package

Isolation Voltage	3750V _{RMS}
Total Power Dissipation	80mW
Operating Temperature	-40 to 100 °C
Storage Temperature	-55 to 125 °C
Lead Soldering Temperature (10s)	260°C

ISOCOM COMPONENTS 2004 LTD

Unit 25B, Park View Road West, Park View Industrial Estate
Hartlepool, Cleveland, TS25 1UD, United Kingdom
Tel: +44 (0)1429 863 609 Fax : +44 (0)1429 863 581
e-mail: sales@isocom.co.uk
<http://www.isocom.com>

ISOCOM COMPONENTS ASIA LTD

Hong Kong Office,
Block A, 8/F, Wah Hing Industrial mansion,
36 Tai Yau Street, San Po Kong, Kowloon, Hong Kong.
Tel: +852 2995 9217 Fax : +852 8161 6292
e-mail sales@isocom.com.hk



ICPL0630, ICPL0631

Truth Table (Positive Logic)

Input	Output
H	L
L	H

ELECTRICAL CHARACTERISTICS ($T_A = -40^\circ\text{C}$ to 85°C unless otherwise specified)

INPUT

Parameter	Symbol	Test Condition	Min	Typ.*	Max	Unit
Forward Voltage	V_F	$I_F = 10\text{mA}$		1.4	1.8	V
Reverse Voltage	V_R	$I_R = 10\mu\text{A}$	5.0			V
Temperature Coefficient of V_F	$\Delta V_F / \Delta T_A$	$I_F = 10\text{mA}$		-1.8		mV/ $^\circ\text{C}$
Input Capacitance	C_{IN}	$V_F = 0\text{V}$, $f = 1\text{MHz}$		60		pF

OUTPUT

Parameter	Symbol	Test Condition	Min	Typ.*	Max	Unit
High Level Supply Current	I_{CCH}	$I_F = 0\text{mA}$, $V_{CC} = 5.5\text{V}$		13	18	mA
Low Level Supply Current	I_{CCL}	$I_F = 10\text{mA}$, $V_{CC} = 5.5\text{V}$		15	21	mA

COUPLED

Parameter	Symbol	Test Condition	Min	Typ.*	Max	Unit
High Level Output Current	I_{OH}	$V_{CC} = 5.5\text{V}$, $V_O = 5.5\text{V}$ $I_F = 250\mu\text{A}$			100	μA
Low Level Output Voltage	V_{OL}	$V_{CC} = 5.5\text{V}$, $I_F = 5\text{mA}$, $I_{OL} = 13\text{mA}$			0.6	V
Input Threshold Current	I_{FT}	$V_{CC} = 5.5\text{V}$, $V_O = 0.6\text{V}$, $I_{OL} = 13\text{mA}$			5	mA

* Typical values at $T_A = 25^\circ\text{C}$



ICPL0630, ICPL0631

ELECTRICAL CHARACTERISTICS ($T_A = -40^\circ\text{C}$ to 85°C unless otherwise specified)

Switching Characteristics ($T_A = -40^\circ\text{C}$ to 85°C , $I_F = 7.5\text{mA}$, $V_{CC} = 5\text{V}$ unless otherwise specified)

Parameter	Symbol	Test Condition	Min	Typ.*	Max	Unit
Propagation Delay Time to Logic Low	T_{PHL}	$R_L = 350\Omega$, $C_L = 15\text{pF}$, $T_A = 25^\circ\text{C}$			100	ns
Propagation Delay Time to Logic High	T_{PLH}	$R_L = 350\Omega$, $C_L = 15\text{pF}$, $T_A = 25^\circ\text{C}$			100	ns
Pulse Width Distortion	$ t_{PHL} - t_{PLH} $	$R_L = 350\Omega$, $C_L = 15\text{pF}$			35	ns
Output Rise Time	t_r	$R_L = 350\Omega$, $C_L = 15\text{pF}$		40		ns
Output Fall Time	t_f	$R_L = 350\Omega$, $C_L = 15\text{pF}$		10		ns
Common Mode Transient Immunity at Logic High	CM_H	ICPL0630 $I_F = 0\text{mA}$, $V_{OH} = 2.0\text{V}$, $V_{CM} = 1\text{kVp-p}$, $R_L = 350\Omega$, $T_A = 25^\circ\text{C}$	5000			V/ μs
		ICPL0631 $I_F = 0\text{mA}$, $V_{OH} = 2.0\text{V}$, $V_{CM} = 1\text{kVp-p}$, $R_L = 350\Omega$, $T_A = 25^\circ\text{C}$	10000			
Common Mode Transient Immunity at Logic Low	CM_L	ICPL0630 $I_F = 7.5\text{mA}$, $V_{OL} = 0.8\text{V}$, $V_{CM} = 1\text{kVp-p}$, $R_L = 350\Omega$, $T_A = 25^\circ\text{C}$	5000			V/ μs
		ICPL0631 $I_F = 7.5\text{mA}$, $V_{OL} = 0.8\text{V}$, $V_{CM} = 1\text{kVp-p}$, $R_L = 350\Omega$, $T_A = 25^\circ\text{C}$	10000			

* Typical values at $T_A = 25^\circ\text{C}$



ELECTRICAL CHARACTERISTICS

Notes :

1. The V_{CC} supply must be bypassed by a $0.1\mu\text{F}$ capacitor or larger with good high frequency characteristic and should be connected as close as possible to the package V_{CC} and GND pins.
2. t_{PLH} – Propagation delay is measured from the 3.75mA level on the HIGH to LOW transition of the input current pulse to the 1.5 V level on the LOW to HIGH transition of the output voltage pulse.
3. t_{PHL} – Propagation delay is measured from the 3.75mA level on the LOW to HIGH transition of the input current pulse to the 1.5 V level on the HIGH to LOW transition of the output voltage pulse.
4. t_r – Rise time is measured from the 10% to the 90% levels on the LOW to HIGH transition of the output pulse.
5. t_f – Fall time is measured from the 90% to the 10% levels on the HIGH to LOW transition of the output pulse.
6. CM_H – The maximum tolerable rate of rise of the common mode voltage to ensure the output will remain in the HIGH state (i.e., $V_{OUT} > 2.0\text{V}$).
7. CM_L – The maximum tolerable rate of rise of the common mode voltage to ensure the output will remain in the LOW output state (i.e., $V_{OUT} < 0.8\text{V}$).



ICPL0630, ICPL0631

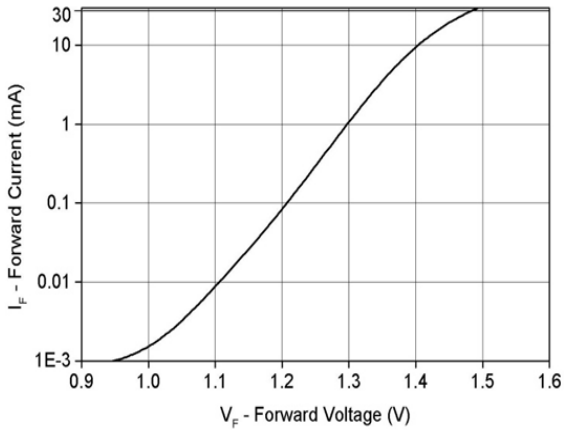

Fig 1 Forward Current vs Forward Voltage

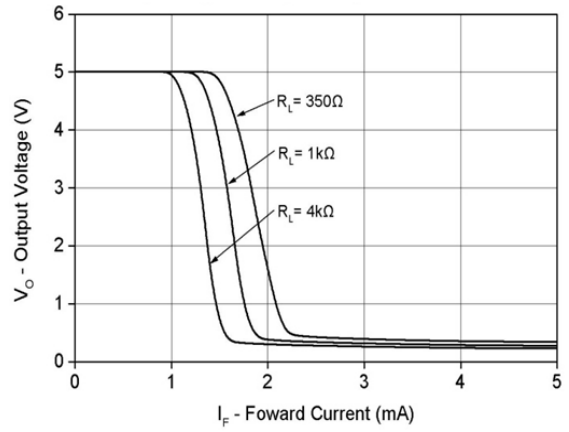

Fig 2 Output Voltage vs Forward Current

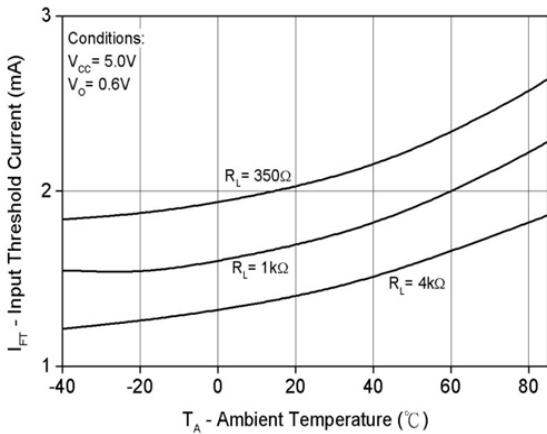

Fig 3 Input Threshold Current vs T_A

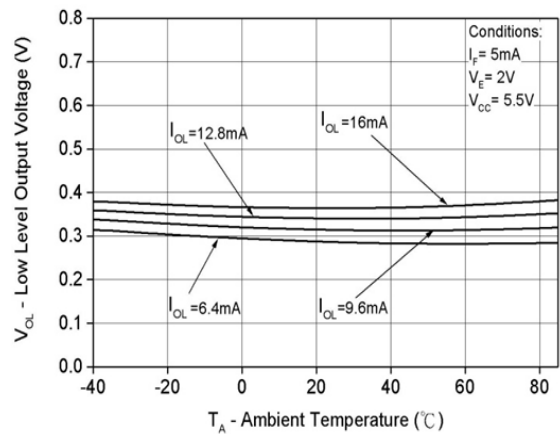

Fig 4 Low Level Output Voltage vs T_A

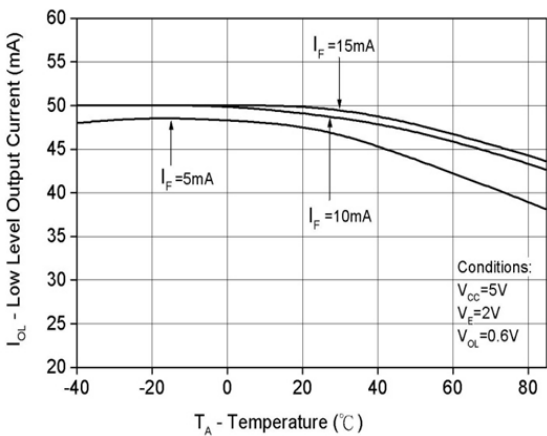

Fig 5 Low Level Output Current vs T_A

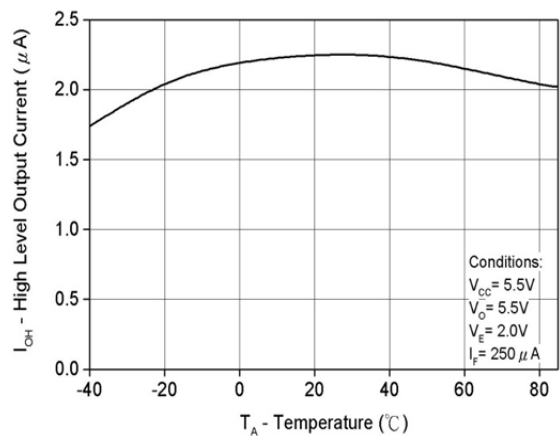

Fig 6 High Level Output Current vs T_A



ICPL0630, ICPL0631

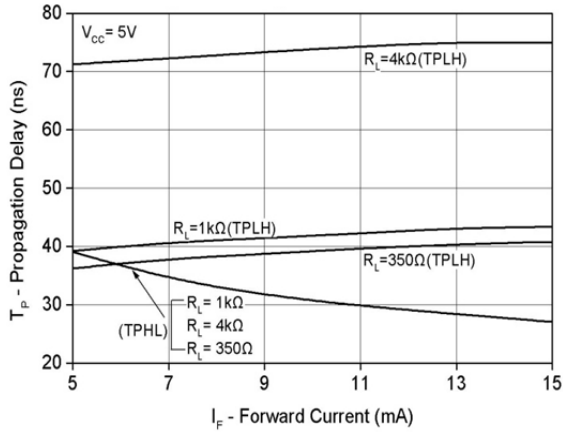

Fig 7 Propagation Delay vs Forward Current

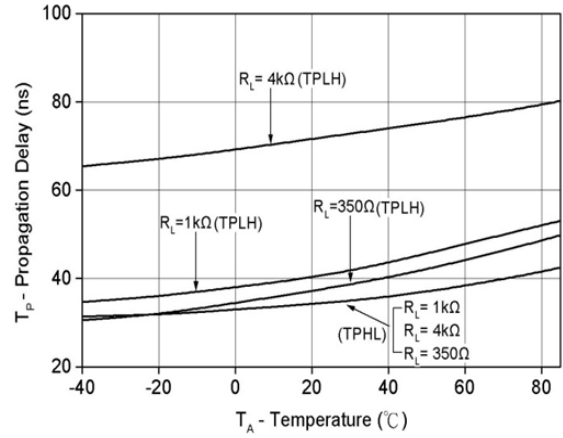

Fig 8 Propagation Delay vs T_A

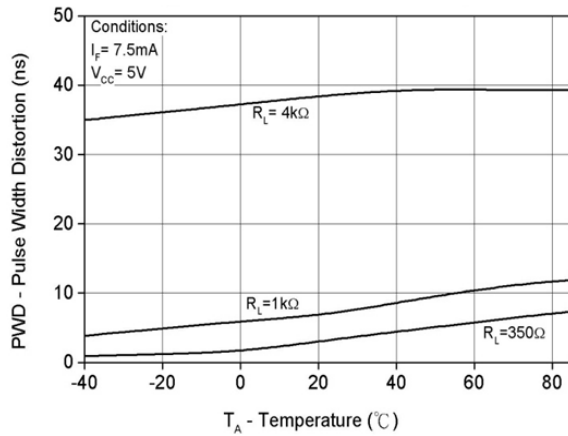

Fig 9 Pulse Width Distortion vs T_A

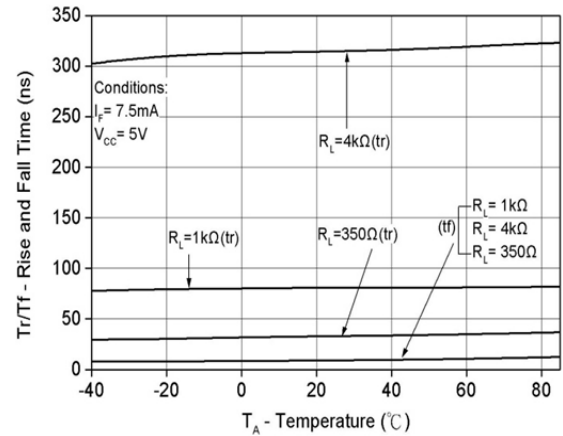

Fig 10 Rise and Fall Time vs T_A



ICPL0630, ICPL0631

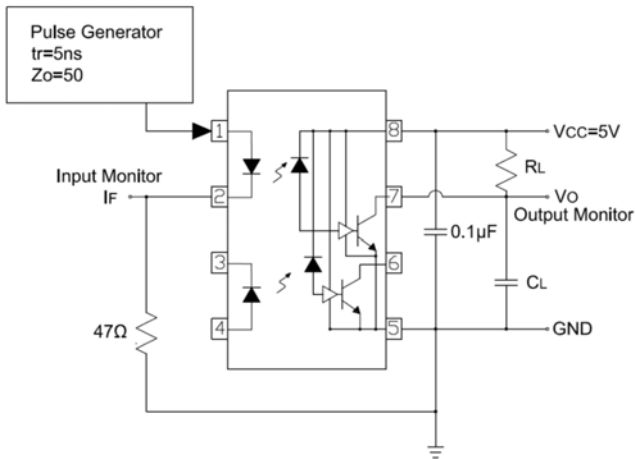

Fig 11 Switching Time Test Circuit

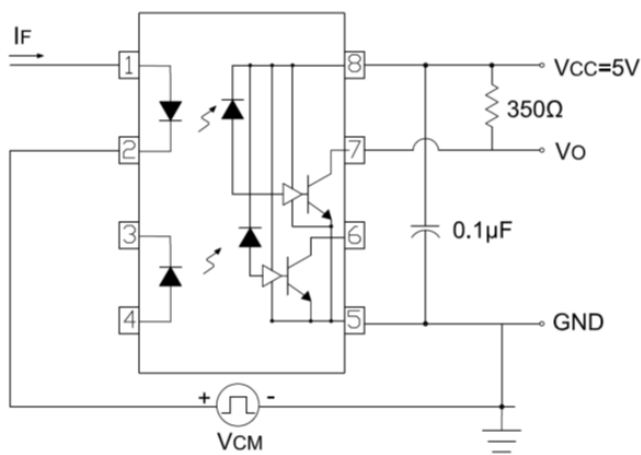
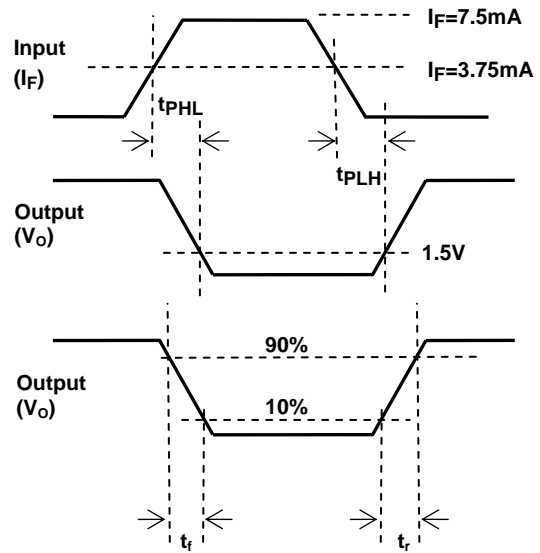
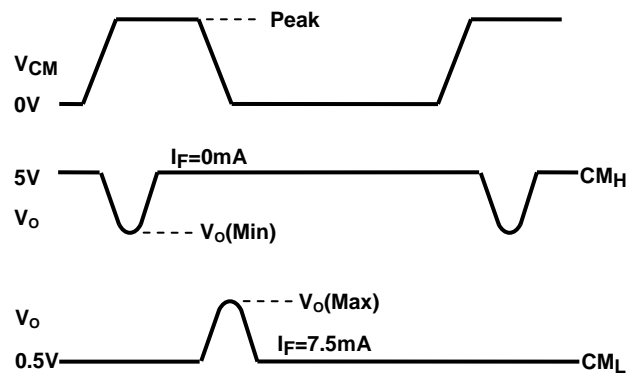

Fig 12 Common Mode Transient Immunity Test Circuit



Common mode transient immunity in logic high level is the maximum tolerable (positive) dV_{CM}/dt on the leading edge of the common mode pulse signal V_{CM} , to assure that the output will remain in a logic high state (i.e., $V_o > 2.0V$).

Common mode transient immunity in logic low level is the maximum tolerable (negative) dV_{CM}/dt on the trailing edge of the common mode pulse signal, V_{CM} , to assure that the output will remain in a logic low state (i.e., $V_o < 0.8V$).



ICPL0630, ICPL0631

ORDER INFORMATION

ICPL0630, ICPL0631			
After PN	PN	Description	Packing quantity
None	ICPL0630, ICPL0631	Surface Mount Tape & Reel	2000 pcs per reel

DEVICE MARKING

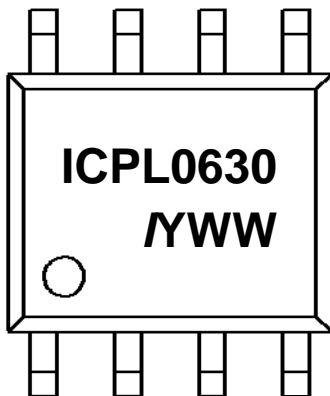

ICPL0630 denotes Device Part Number (ICPL0630 is used as example)
Y denotes 1 digit Year code
WW denotes 2 digit Week code
/ denotes Isocom



ICPL0630, ICPL0631

PACKAGE DIMENSIONS (mm)

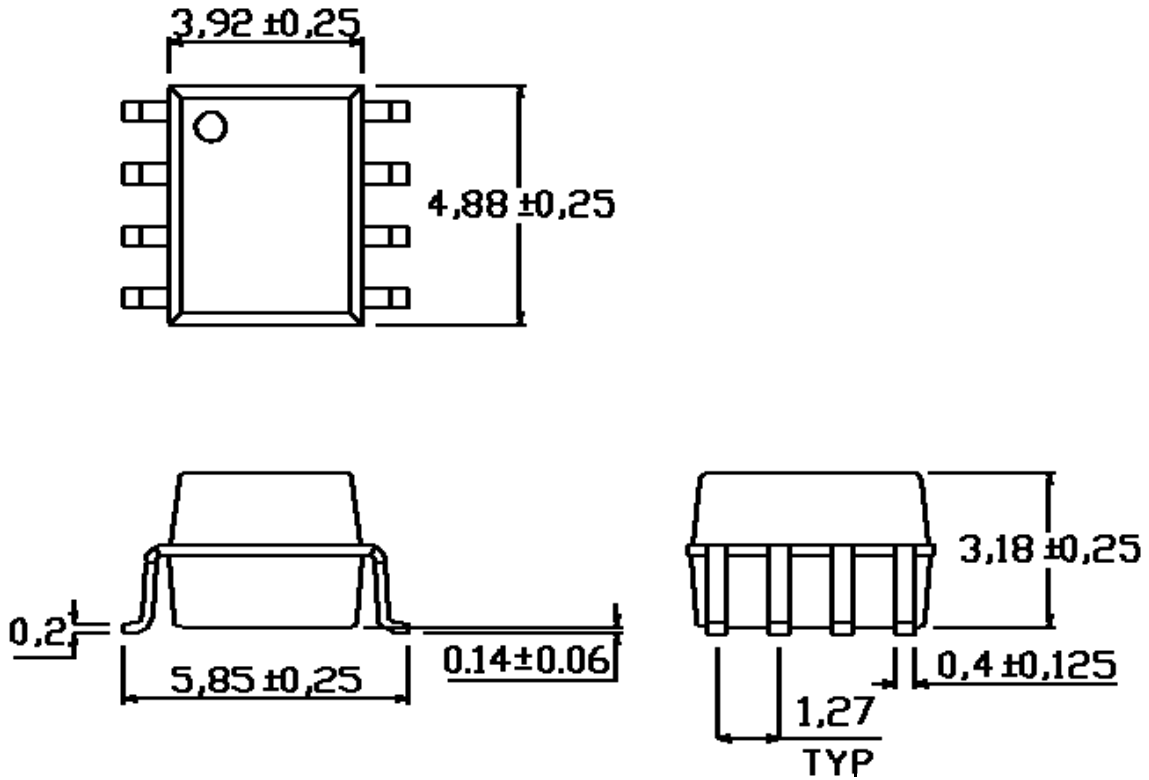

RECOMMENDED PAD LAYOUT (mm)

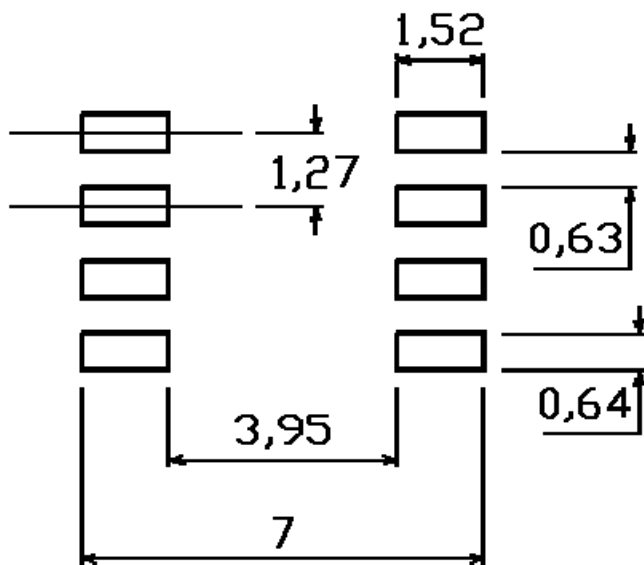



IR REFLOW SOLDERING TEMPERATURE PROFILE
(One Time Reflow Soldering is Recommended)

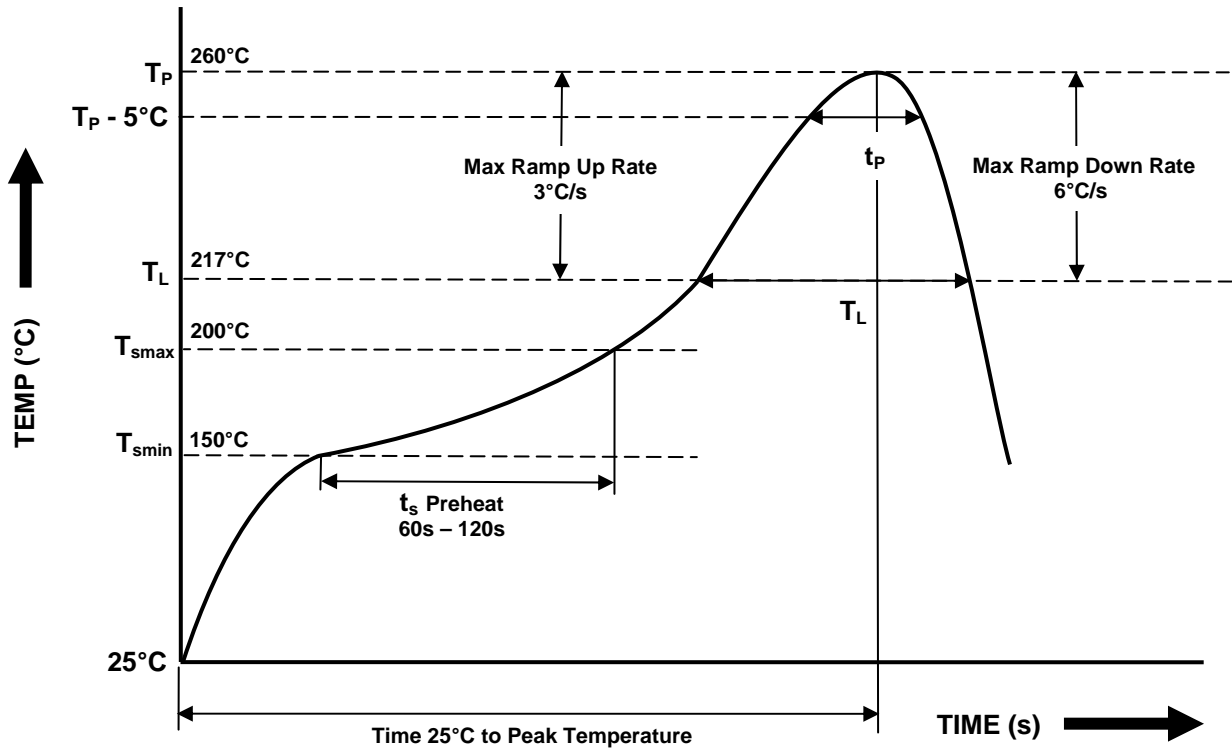

Profile Details	Conditions
Preheat - Min Temperature (T_{SMIN}) - Max Temperature (T_{SMAX}) - Time T_{SMIN} to T_{SMAX} (t_s)	150°C 200°C 60s - 120s
Soldering Zone - Peak Temperature (T_P) - Liquidous Temperature (T_L) - Time within 5°C of Actual Peak Temperature ($T_P - 5^\circ\text{C}$) - Time maintained above T_L (t_L) - Ramp Up Rate (T_L to T_P) - Ramp Down Rate (T_P to T_L)	260°C 217°C 30s 60s - 100s 3°C/s max 6°C/s max
Average Ramp Up Rate (T_{smax} to T_P)	3°C/s max
Time 25°C to Peak Temperature	8 minutes max



ICPL0630, ICPL0631

TAPE AND REEL PACKAGING

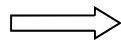
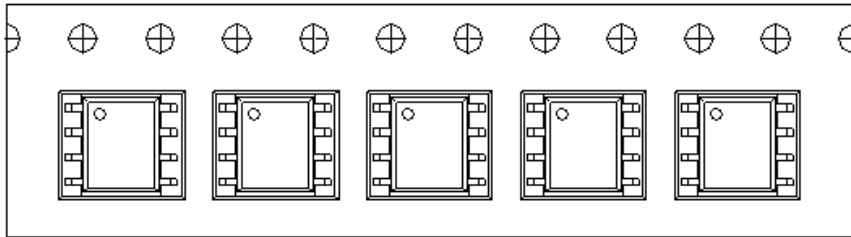

Direction of feed from reel

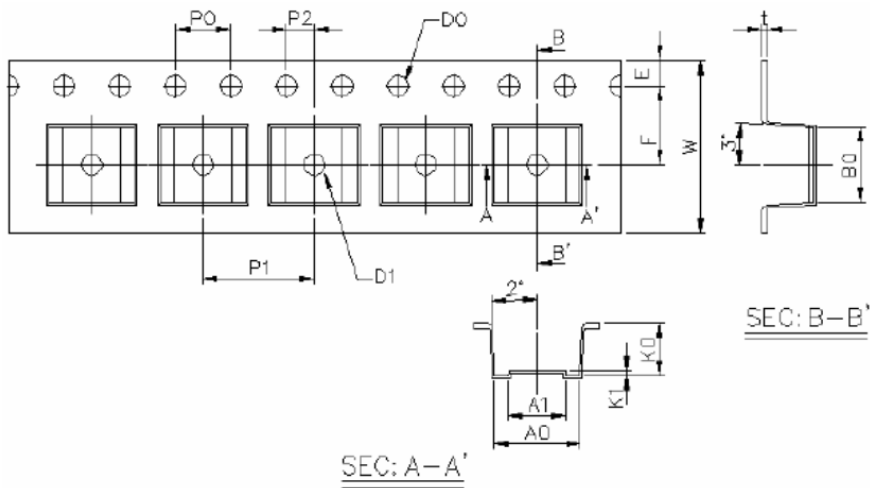

Dimension No.	A0	A1	B0	D0	D1	E	F
Dimension (mm)	6.2±0.1	4.1±0.1	5.28±0.1	1.5±0.1	1.5±0.3	1.75±0.1	5.5±0.1
Dimension No.	Po	P1	P2	t	W	K0	K1
Dimension (mm)	4.0±0.1	8.0±0.1	2.0±0.1	0.4±0.1	12.0 +0.3/-0.1	3.7±0.1	0.3±0.1

X-ON Electronics

Largest Supplier of Electrical and Electronic Components

Click to view similar products for [High Speed Optocouplers](#) category:

Click to view products by [Isocom](#) manufacturer:

Other Similar products are found below :

[6N136F](#) [HCPL-2201-300](#) [JAN4N24](#) [610737H](#) [HCPL2630M](#) [HCPL2630SM](#) [PS9817A-1-F3-AX](#) [PS9821-2-F3-AX](#) [TLP2766A\(E](#)
[TLP2766A\(LF4,E](#) [PS9121-F3-AX](#) [TLP5774H\(TP4,E](#) [TLP5771H\(TP,E](#) [TLP2304\(E\(O](#) [054279X](#) [HCPL2631SD](#) [HCPL-2730-500E](#)
[TLP118\(TPL,E\)](#) [TLP2309\(E\(T](#) [TLP2366\(TPL,E](#) [TLP2368\(TPL,E\(T](#) [TLP521-2XGB](#) [TLP621-2XGB](#) [JANTXV4N24U](#) [8102802PC](#) [5962-](#)
[8767902XA](#) [5962-8876801XA](#) [5962-8957101PA](#) [SFH6318T](#) [6N135-300E](#) [TIL198](#) [TLP104\(TPR,E\)](#) [TLP2309\(TPL,E\)](#) [TLP2355\(TPL,E](#)
[TLP2358\(E\)](#) [TLP521-4GR](#) [TLP521-4XGB](#) [TLP621XSM](#) [5962-8876801PA](#) [IS281-4GB](#) [IS2805-4](#) [IS181GR](#) [ICPL2630](#) [ICPL2531](#)
[ICPL2601](#) [ICPL2530](#) [5962-8876801PC](#) [TLP2301](#) [TLP2301\(E\(T](#) [TLP2362\(TPR,E](#)