

IS3H7



DESCRIPTION

The IS3H7 series optocoupler consists of an infrared emitting diode optically coupled to an NPN silicon photo transistor.

This device belongs to Isocom Compact Range of Optocouplers.

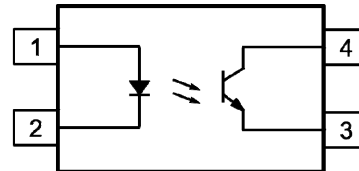

- 1 Anode
- 2 Cathode
- 3 Emitter
- 4 Collector

FEATURES

- Half Pitch 1.27mm
- High AC Isolation voltage 3750V_{RMS}
- CTR Selections Available
- Wide Operating Temperature Range -55°C to 110°C
- Pb Free and RoHS Compliant
- UL Approval E91231, Model "THP"

APPLICATIONS

- Switching Mode Power Supply
- Industrial System Controllers
- Measuring Instruments
- Signal Transmission between Systems of Different Potentials and Impedances

ORDER INFORMATION

- Available in Tape and Reel with 1000pcs per reel

ABSOLUTE MAXIMUM RATINGS (T_A = 25°C)

Stresses exceeding the absolute maximum ratings can cause permanent damage to the device.

Exposure to absolute maximum ratings for long periods of time can adversely affect reliability.

Input

Forward Current	50mA
Reverse Voltage	6V
Power dissipation	70mW

Output

Collector to Emitter Voltage BV _{CEO}	80V
Emitter to Collector Voltage BV _{ECO}	7V
Collector Current	50mA
Power Dissipation	150mW

Total Package

Isolation Voltage	3750V _{RMS}
Total Power Dissipation	200mW
Operating Temperature	-55 to 110 °C
Storage Temperature	-55 to 150 °C
Lead Soldering Temperature (10s)	260°C

ISOCOM COMPONENTS 2004 LTD

Unit 25B, Park View Road West, Park View Industrial Estate
Hartlepool, Cleveland, TS25 1PE, United Kingdom
Tel : +44 (0)1429 863 609 Fax : +44 (0)1429 863 581
e-mail : sales@isocom.co.uk
<http://www.isocom.com>

ISOCOM COMPONENTS ASIA LTD

Hong Kong Office
Block A, 8/F, Wah Hing Industrial Mansion
36 Tai Yau Street, San Po Kong, Kowloon, Hong Kong
Tel : +852 2995 9217 Fax : +852 8161 6292
e-mail : sales@isocom.com.hk

IS3H7

ELECTRICAL CHARACTERISTICS ($T_A = 25^\circ\text{C}$ unless otherwise specified)

INPUT

Parameter	Symbol	Test Condition	Min	Typ.	Max	Unit
Forward Voltage	V_F	$I_F = 20\text{mA}$		1.2	1.4	V
Reverse Current	I_R	$V_R = 4\text{V}$			10	μA
Terminal Capacitance	C_{IN}	$V = 0\text{V}, f = 1\text{KHz}$		30	250	pF

OUTPUT

Parameter	Symbol	Test Condition	Min	Typ.	Max	Unit
Collector-Emitter Breakdown Voltage	BV_{CEO}	$I_C = 0.1\text{mA}, I_F = 0\text{mA}$	80			V
Emitter-Collector Breakdown Voltage	BV_{ECO}	$I_E = 0.1\text{mA}, I_F = 0\text{mA}$	7			V
Collector-Emitter Dark Current	I_{CEO}	$V_{CE} = 20\text{V}, I_F = 0\text{mA}$			100	nA

IS3H7

ELECTRICAL CHARACTERISTICS ($T_A = 25^\circ\text{C}$ unless otherwise specified)

COUPLED

Parameter	Symbol	Test Condition	Min	Typ.	Max	Unit	
Current transfer ratio	CTR	$I_F = 5\text{mA}, V_{CE} = 5\text{V}$				%	
		IS3H7	50		600		
		IS3H7A	80		160		
		IS3H7B	130		260		
		IS3H7C	200		400		
		IS3H7D	300		600		
		IS3H7E	100		200		
		IS3H7F	150		300		
		IS3H7GB	100		600		
		$I_F = 10\text{mA}, V_{CE} = 5\text{V}$					
		IS3H7H	40		80		
		IS3H7I	63		125		
		IS3H7J	100		200		
		IS3H7K	160		320		
IS3H7GR	100		300				
Collector-Emitter Saturation Voltage	$V_{CE(sat)}$	$I_F = 10\text{mA}, I_C = 1\text{mA}$		0.1	0.2	V	
Floating Capacitance	C_f	$V_F = 0\text{V}, f = 1\text{MHz}$		0.3		pF	
Output Rise Time	t_r	$V_{CE} = 2\text{V}, I_c = 2\text{mA}, R_L = 100\Omega$		6	18	μs	
Output Fall Time	t_f	$V_{CE} = 2\text{V}, I_c = 2\text{mA}, R_L = 100\Omega$		6	18	μs	

ISOLATION

Parameter	Symbol	Test Condition	Min	Typ.	Max	Unit
Isolation Voltage	V_{ISO}	R.H. = 40% to 60%, $t = 1\text{ min}$ Note 1	3750			V_{RMS}
Input - Output Resistance	R_{I-O}	$V_{I-O} = 500\text{VDC}$ R.H. = 40% to 60% Note 1	5×10^{10}			Ω

Note 1 : Measured with input leads shorted together and output leads shorted together.

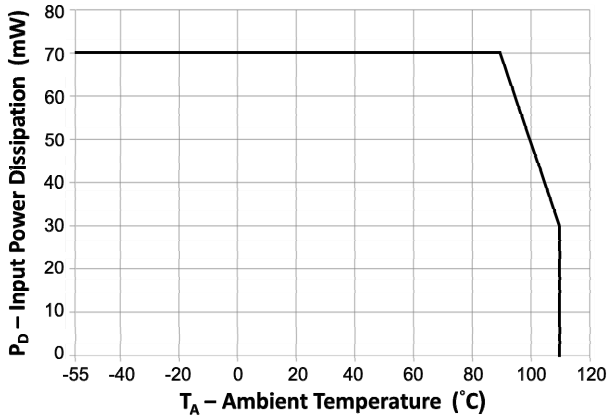

Fig 1 Input Power Dissipation vs Ambient Temperature

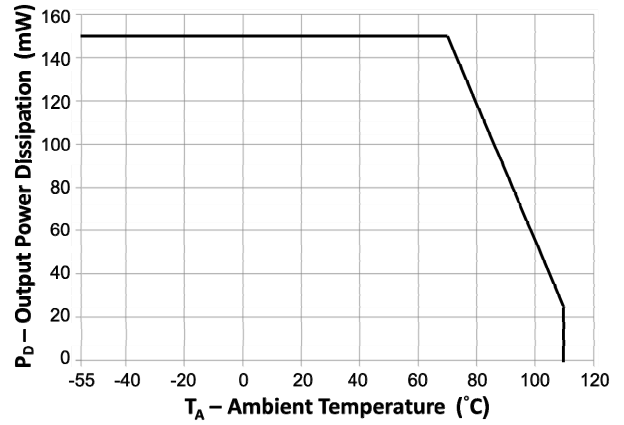

Fig 2 Output Power Dissipation vs Ambient Temperature

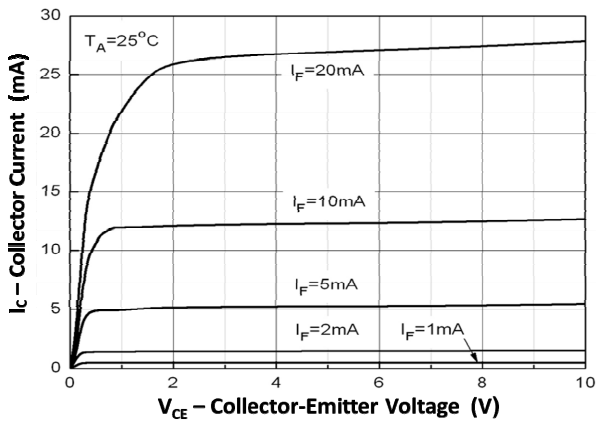

Fig 3 Collector Current vs Collector-Emitter Voltage (1)

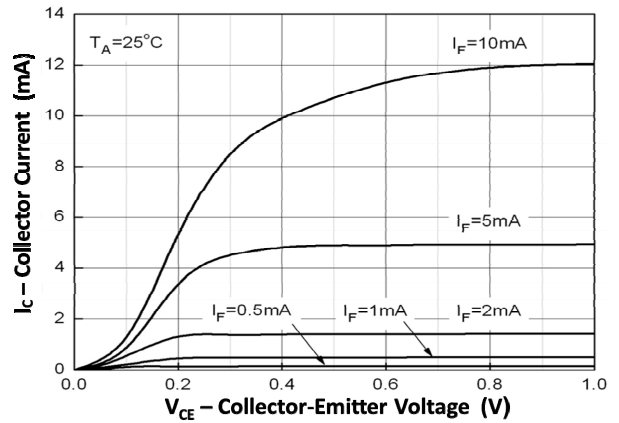

Fig 4 Collector Current vs Collector-Emitter Voltage (2)

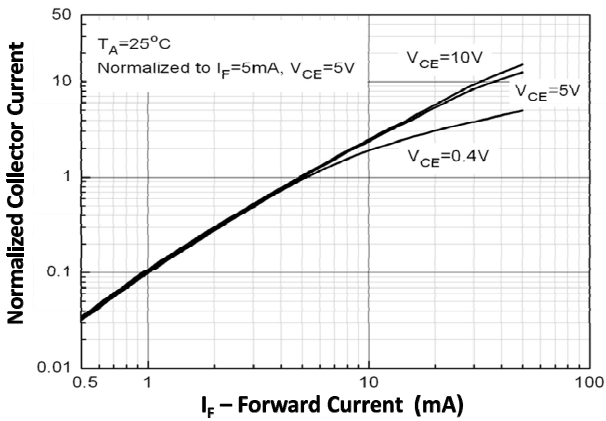

Fig 5 Normalized Collector Current vs Forward Voltage

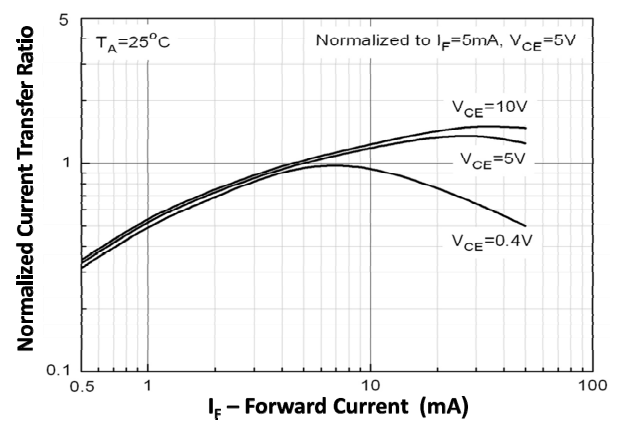

Fig 6 Collector Current Transfer Ratio vs Forward Current

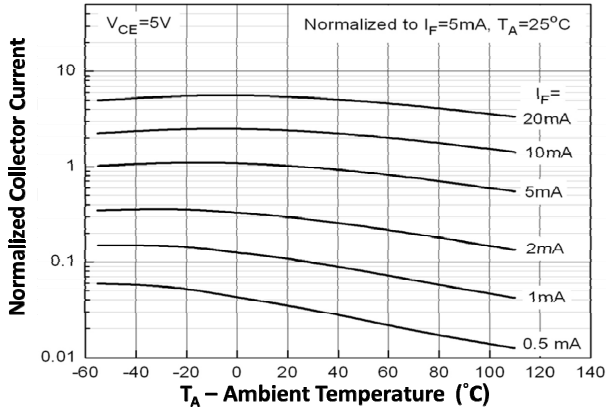

Fig 7 Normalized Collector Current vs Ambient Temperature

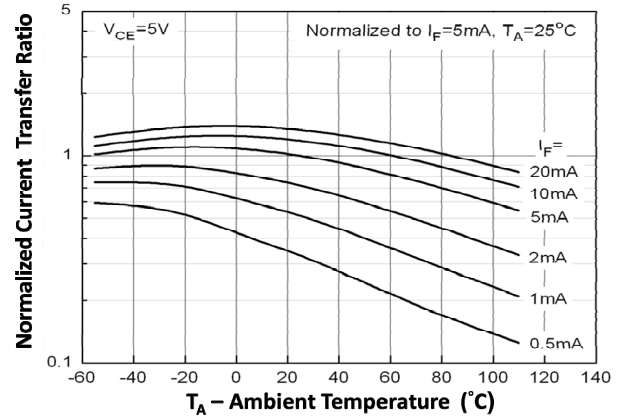

Fig 8 Normalized Current Transfer Ratio vs Ambient Temperature

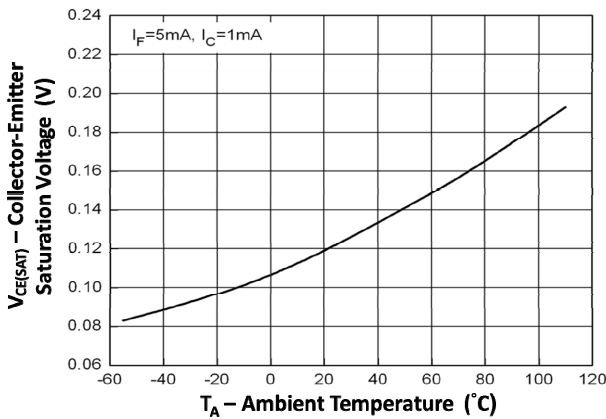

Fig 9 Collector-Emitter Voltage vs Ambient Temperature

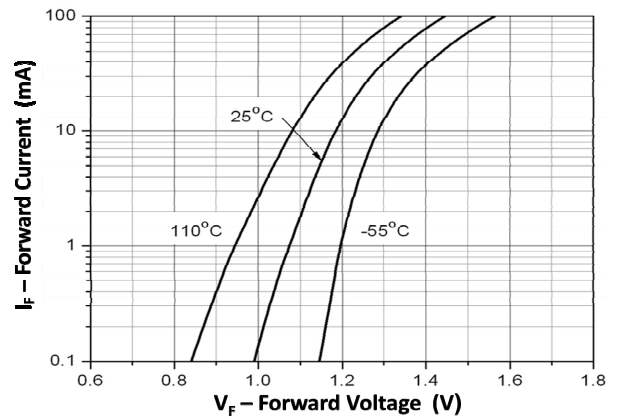

Fig 10 Forward Current vs Forward Voltage

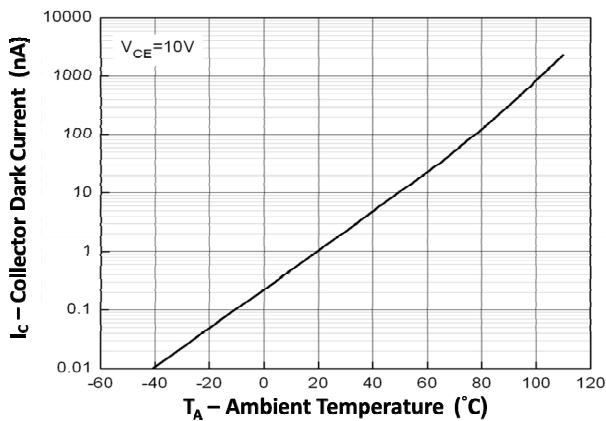

Fig 11 Collector Dark Current vs Ambient Temperature

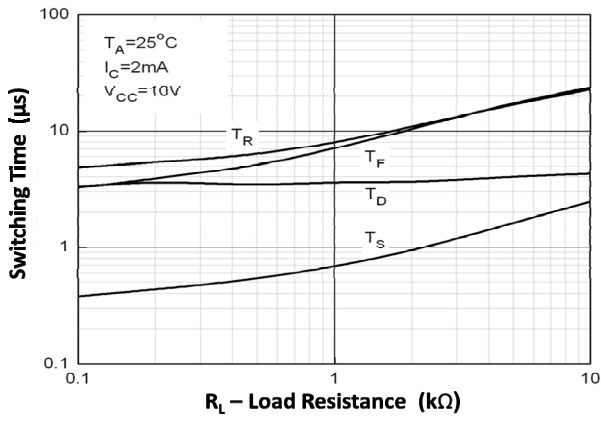
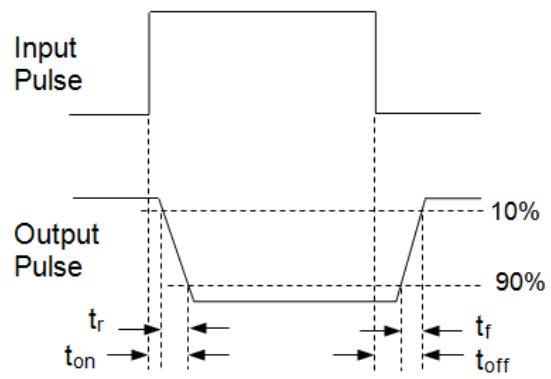
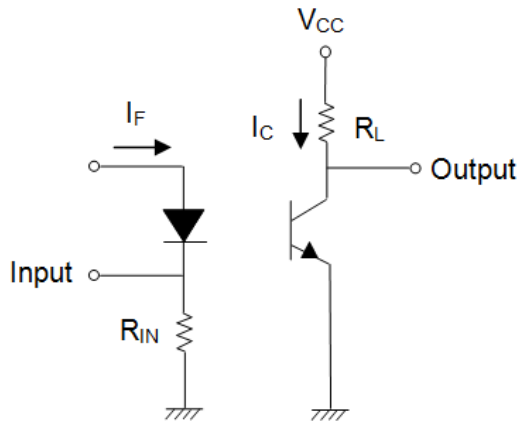

Fig 12 Switching Time vs Load Resistance



Switching Time Test Circuit

IS3H7

ORDER INFORMATION

IS3H7			
After PN	PN	Description	Packing quantity
None	IS3H7	Surface Mount Tape & Reel	1000 pcs per reel
Any CTR Grade	IS3H7A, IS3H7B, IS3H7C, IS3H7D, IS3H7E, IS3H7F, IS3H7H, IS3H7I, IS3H7J, IS3H7K, IS3H7GR, IS3H7GB	Surface Mount Tape & Reel	1000 pcs per reel

NOTE : Multiple Grades may be supplied to meet the requested specification

DEVICE MARKING



THP_ denotes Device Part Number where “_” denotes CTR Grade

I denotes Isocom

Y denotes 1 digit Year code

WW denotes 2 digit Week code

Note :	Device	Marking
	IS3H7	THP1
	IS3H7B	THP3
	IS3H7C	THP9
	IS3H7F	THP10

IS3H7

PACKAGE DIMENSIONS (mm)

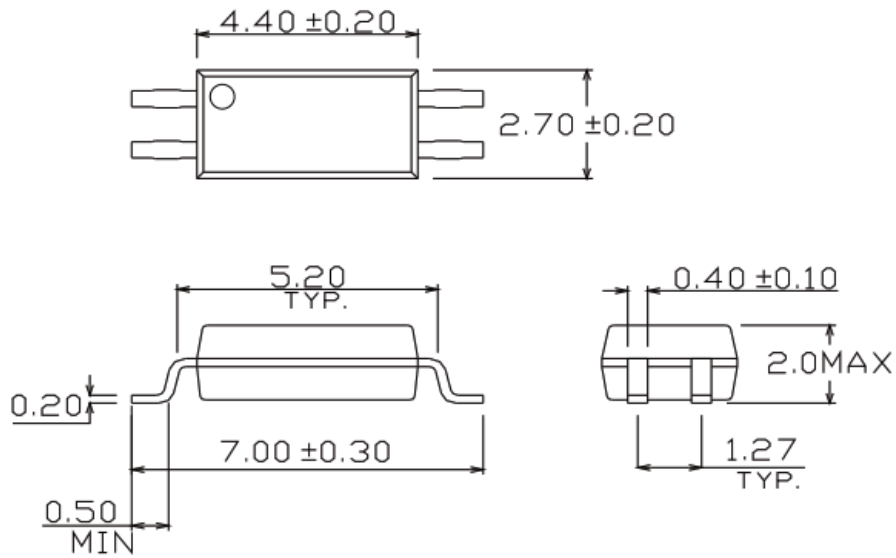

RECOMMENDED SOLDER PAD LAYOUT (mm)

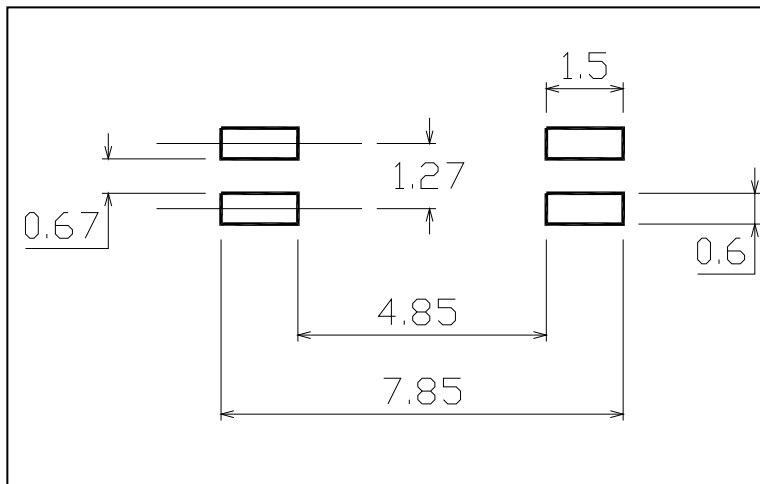

IS3H7

Tape and Reel Packaging

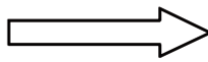
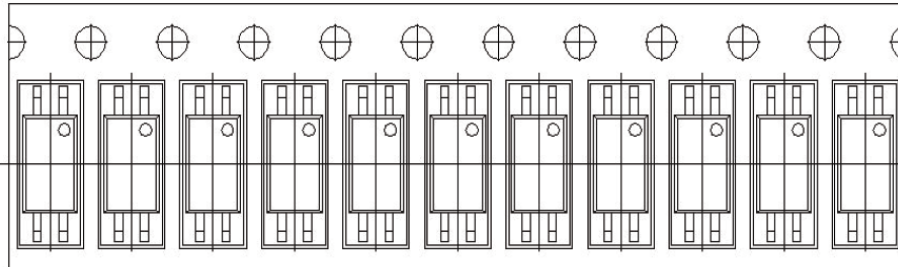

Direction of feed from reel

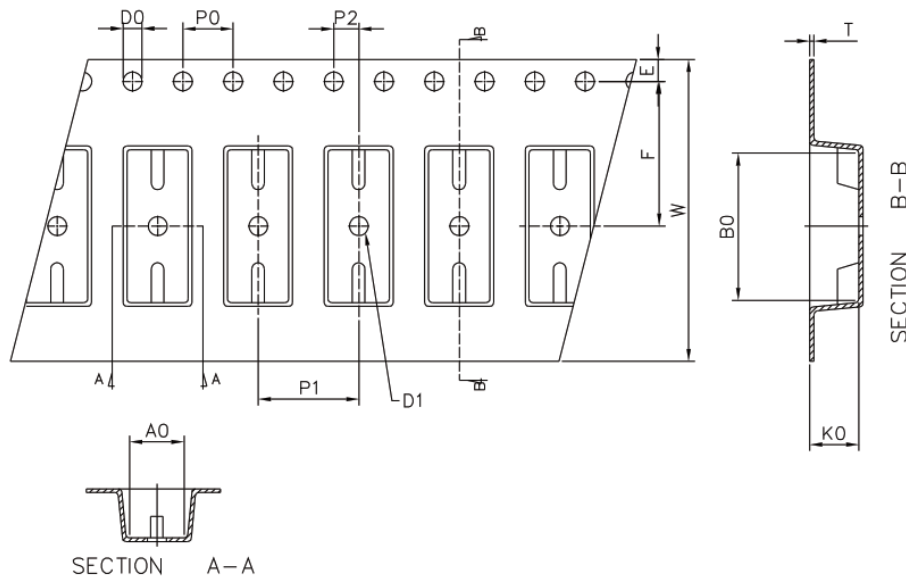

Dimension No.	A0	B0	D0	D1	E	F
Dimension(mm)	3.00±0.10	7.45±0.10	1.50+0.1/-0	1.50±0.10	1.75±0.10	5.5±0.10
Dimension No.	P0	P1	P2	t	W	K0
Dimension (mm)	4.00±0.15	4.00±0.10	2.00±0.10	0.30±0.05	12.1±0.2	2.45±0.1

IR REFLOW SOLDERING TEMPERATURE PROFILE

One Time Reflow Soldering is Recommended.
Do not immerse device body in solder paste.

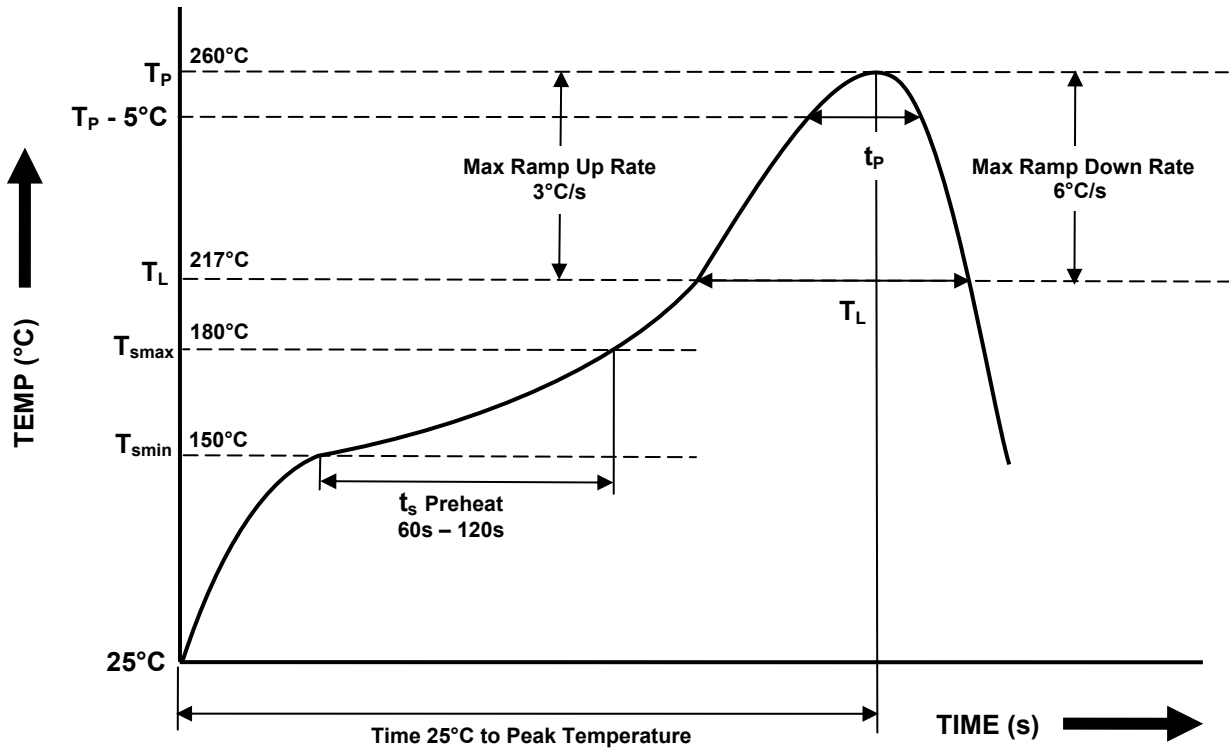

Profile Details	Conditions
Preheat - Min Temperature (T _{SMIN}) - Max Temperature (T _{SMAX}) - Time T _{SMIN} to T _{SMAX} (t _s)	150°C 180°C 60s - 120s
Soldering Zone - Peak Temperature (T _P) - Liquidous Temperature (T _L) - Time within 5°C of Actual Peak Temperature (T _P - 5°C) - Time maintained above T _L (t _L) - Ramp Up Rate (T _L to T _P) - Ramp Down Rate (T _P to T _L)	260°C 217°C 20s 60s 3°C/s max 3 - 6°C/s
Average Ramp Up Rate (T _{smax} to T _P)	3°C/s max
Time 25°C to Peak Temperature	8 minutes max



DISCLAIMER

Isocom Components is continually working to improve the quality and reliability of its products. Nevertheless, semiconductor devices in general can malfunction or fail due to their inherent electrical sensitivity and vulnerability to physical stress. It is the responsibility of the buyer, when utilizing Isocom Components products, to comply with the standards of safety in making a safe design for the entire system, and to avoid situations in which a malfunction or failure of such Isocom Components products could cause loss of human life, bodily injury or damage to property.

In developing your designs, please ensure that Isocom Components products are used within specified operating ranges as set forth in the most recent Isocom Components products specifications.

The Isocom Components products listed in this document are intended for usage in general electronics applications (computer, personal equipment, office equipment, measuring equipment, industrial robotics, domestic appliances, etc.). These Isocom Components products are neither intended nor warranted for usage in equipment that requires extraordinarily high quality and/or reliability or a malfunction or failure of which may cause loss of human life or bodily injury ("Unintended Usage"). Unintended Usage include atomic energy control instruments, airplane or spaceship instruments, transportation Instruments, traffic signal instruments, combustion control instruments, medical Instruments, all types of safety devices, etc... Unintended Usage of Isocom Components products listed in this document shall be made at the customer's own risk.

Gallium arsenide (GaAs) is a substance used in the products described in this document. GaAs dust and fumes are toxic. Do not break, cut or pulverize the product, or use chemicals to dissolve them. When disposing of the products, follow the appropriate regulations. Do not dispose of the products with other industrial waste or with domestic garbage.

The products described in this document are subject to the foreign exchange and foreign trade laws.

The information contained herein is presented only as a guide for the applications of our products. No responsibility is assumed by Isocom Components for any infringements of intellectual property or other rights of the third parties which may result from its use. No license is granted by implication or otherwise under any intellectual property or other rights of Isocom Components or others.

X-ON Electronics

Largest Supplier of Electrical and Electronic Components

Click to view similar products for [Photodiode Output Optocouplers](#) category:

Click to view products by [Isocom](#) manufacturer:

Other Similar products are found below :

[TLP590B\(C,F\)](#) [TLP7820\(A-LF4.E\(O](#) [LTV-244-GB-G](#) [LTV2301GB-V-G](#) [EL816S1\(C\)\(TU\)](#) [EL817S1\(C\)\(TU\)-VG](#) [GX357NC](#) [PC817B](#)
[PC817C](#) [LTV-341W-TA1-H](#) [LTV-176G](#) [LTV-1003-TP1-G](#) [LTV-247-G-RT](#) [PC817B-MS](#) [FOC-817C-F](#) [CYPS2501-1\(K\)](#)
[CYTLP2362\(TPD2\)](#) [OR-3H7C-TP-G-\(GK\)](#) [ORPC-817MC-F](#) [ORPC-817D-C](#) [ORPC-817SB-TP-F](#) [PS2801C-4-F3-A/M](#) [PC817B](#)
[TLP183\(YH-TPL,E\(T](#) [TLP183\(GRH-TPL,E\(T](#) [TLP183\(TPL,E\(T](#) [TLP291\(BL-TP,SE\(T](#) [TLP184\(V4GBTL,SE\(T](#) [TLP785\(BLL-TP6,F\(C](#)
[TLP293\(GRH-TPL,E\(T](#) [TLP383\(D4GL-TR,E](#) [TLP185\(BLL-TL,SE\(T](#) [TLP2309\(TPL,E\(O](#) [TLP785\(BL-TP6,F\(C](#) [TLP185\(GRL-TL,SE\(T](#)
[TLP785\(GR-TP6,F\(C](#) [TLP183\(BL-TPL,E\(T](#) [TLP2398\(TPL,E\(T](#) [TLP127GB-S](#) [LTV-354T-A\(UMW\)](#) [6N136S\(UMW\)](#) [PC817B-S](#) [FOC-817C](#)
[EL1018](#) [IS121A](#) [IS3H7A](#) [IS121D](#) [IS121GB](#) [IS2701-1BL](#) [IS180](#)