

IS32LT3175N/P

SINGLE CHANNEL LINEAR LED DRIVER WITH FADE IN/OUT AND PWM DIMMING

July 2016

GENERAL DESCRIPTION

The IS32LT3175 is a single channel linear programmable current regulator capable of up to 150mA. It integrates a debounce and latch circuit on the channel enable pin (EN) to facilitate the use of a low cost momentary contact switch. The PWM pin can be interfaced to a logic level “courtesy light” signal to directly drive the LED channel. The IS32LT3175P accepts a positive polarity PWM signal while the IS32LT3175N accepts a negative polarity PWM signal.

The device operates as a stand-alone LED driver configurable with external resistors; no microcontroller is required. A single external resistor programs the current level, while two separate resistors independently program the fade in and fade out ramp rate for the channel.

The device integrates a 63 steps fade in and fade out algorithm (Gamma correction) which causes the output LED current to gradually ramp up to the full source value after the EN pin is pulsed. The same controller causes the LED current to gradually ramp down to zero if the EN pin is pulsed while the output channel is ON. The fade ramp can be interrupted mid-cycle before completion of the ramp cycle. The EN pin will accept either a momentary contact switch or logic level signal pulsed low.

The IS32LT3175 is targeted at the automotive market with end applications to include map and dome lighting as well as exterior accent lighting. For 12V automotive applications the low dropout driver can support 1 to 3 LEDs ($V_F = 3.2V$) per channel. It is offered in a small thermally enhanced SOP-8-EP package.

FEATURES

- Operating voltage 5V to 42V
- Single channel current source
 - Programmable current via a single external resistor
 - Configurable from 20mA to 150mA
- Momentary contact button EN input
 - Input is debounced and latched
 - Higher priority than PWM input
 - Gamma corrected Fade In/Out algorithm
 - Pull down resistors set independent fade IN and OUT ramp time
- PWM input pin driven by external PWM source
 - PWM directly drives the current source
 - IS32LT3175P – Positive polarity
 - IS32LT3175N – Negative polarity
- Fault Protection:
 - OUT pin shorted to GND
 - ISET pin shorted to GND
 - Over temperature
- SOP-8-EP package
- Automotive Grade:
 - IS32LT3175P – AEC-Q100
 - IS32LT3175N – AEC-Q100
- Operating temperature range from $-40^{\circ}C \sim +125^{\circ}C$

APPLICATIONS

- Automotive Interior:
 - Map/Dome light
 - Puddle lamp in doors
 - Glove box
 - Vanity mirror

TYPICAL APPLICATION CIRCUIT

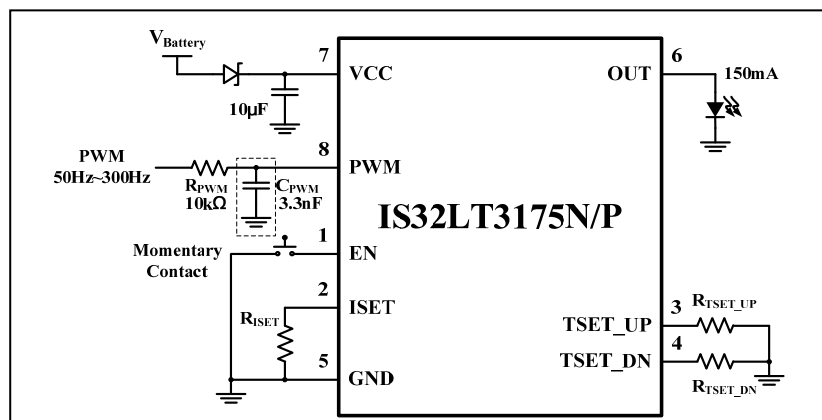
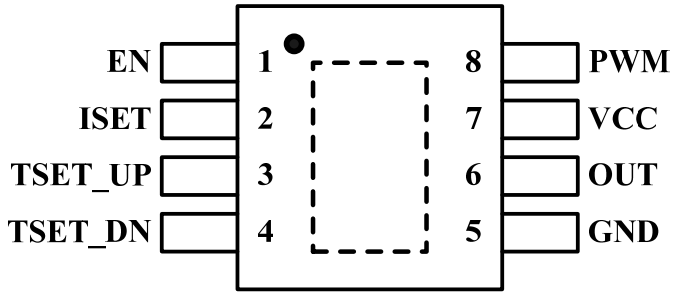

Figure 1 Typical Application Circuit

Note: The resistor R_{PWM} is a fixed value. Please don't change it. C_{PWM} is optional. Add it for robust electromagnetic susceptibility.

IS32LT3175N/P

PIN CONFIGURATION

Package	Pin Configuration (Top view)
SOP-8-EP	

PIN DESCRIPTION

No.	Pin	Description
1	EN	Internally debounced input pin for control of LED current. A negative going pulse on this pin will toggle the state of the OUT current. The pin condition is constantly monitored after the debounce time period.
2	ISET	Output current setting for channel. Connect a resistor between this pin and GND to set the maximum output current.
3	TSET_UP	Timing control for the Fade In feature. Connect a resistor between this pin and GND to set the Fade In time. Connect this pin directly to ground to disable the fade function for instant ON.
4	TSET_DN	Timing control for the Fade Out feature. Connect a resistor between this pin and GND to set the Fade Out time. Connect this pin directly to ground to disable the fade function for instant OFF.
5	GND	Ground pin for the device.
6	OUT	Output current source channel.
7	VCC	Power supply input pin. A capacitor on this pin will help maintain EN latch status during low voltage conditions.
8	PWM	PWM (or BCM) signal via a 10kΩ to drive OUT pin. Pin condition is ignored if EN pin has latched and activated OUT pin. IS32LT3175P positive polarity, IS32LT3175N negative polarity.
	Thermal Pad	Connect to GND.

IS32LT3175N/P

ORDERING INFORMATION

Automotive Range: -40°C to +125°C

Order Part No.	Package	QTY/Reel
IS32LT3175P-GRLA3-TR IS32LT3175N-GRLA3-TR	SOP-8-EP, Lead-free	2500

Copyright © 2016 Lumissil Microsystems. All rights reserved. Lumissil Microsystems reserves the right to make changes to this specification and its products at any time without notice. Lumissil Microsystems assumes no liability arising out of the application or use of any information, products or services described herein. Customers are advised to obtain the latest version of this device specification before relying on any published information and before placing orders for products.

Lumissil Microsystems does not recommend the use of any of its products in life support applications where the failure or malfunction of the product can reasonably be expected to cause failure of the life support system or to significantly affect its safety or effectiveness. Products are not authorized for use in such applications unless Lumissil Microsystems receives written assurance to its satisfaction, that:

- a.) the risk of injury or damage has been minimized;
- b.) the user assume all such risks; and
- c.) potential liability of Lumissil Microsystems is adequately protected under the circumstances

IS32LT3175N/P

ABSOLUTE MAXIMUM RATINGS

VCC, OUT, PWM	-0.3V ~ +45V
EN, ISET, TSET_UP, TSET_DN	-0.3V ~ +7.0V
Ambient operating temperature, $T_A=T_J$	-40°C ~ +125°C
Maximum continuous junction temperature, $T_{J(MAX)}$	150°C
Storage temperature range, T_{STG}	-55°C ~ +150°C
Maximum power dissipation, P_{DMAX}	1.96W
ESD (HBM)	±2kV
ESD (CDM)	±750V

Note: Stresses beyond those listed under “Absolute Maximum Ratings” may cause permanent damage to the device. These are stress ratings only and functional operation of the device at these or any other condition beyond those indicated in the operational sections of the specifications is not implied. Exposure to absolute maximum rating conditions for extended periods may affect device reliability.

THERMAL CHARACTERISTICS

Characteristic	Test Conditions	Value
Package Thermal Resistance (Junction to Ambient), θ_{JA}	On 4-layer PCB based on JEDEC standard at 1W, $T_A=25^\circ\text{C}$	50.98°C/W
Package Thermal Resistance (Junction to Pad), θ_{JP}		2.24°C/W

ELECTRICAL CHARACTERISTICS

$T_J = -40^\circ\text{C} \sim +125^\circ\text{C}$, $V_{CC}=12\text{V}$, refer to each condition description. Typical values are at $T_J = 25^\circ\text{C}$.

Symbol	Parameter	Condition	Min.	Typ.	Max.	Unit
V_{CC}	Supply voltage range		5		42	V
V_{DO}	Minimum dropout voltage	$V_{CC} - V_{OUT}$, $I_{OUT} = -150\text{mA}$ (Note 1)			900	mV
		$V_{CC} - V_{OUT}$, $I_{OUT} = -100\text{mA}$ (Note 2)			700	mV
I_{CC}	Quiescent supply current	PWM pin floating. EN disables the output.	0.1		1	mA
		$R_{ISET} = 15\text{k}\Omega$, EN enable the output, PWM floating, OUT floating		2.3	3.8	mA
		$V_{CC} = 4.2\text{V}$, EN enable the output. $V_{PWM} = 4\text{V}$ for IS32LT3175P and $V_{PWM} = \text{GND}$ for IS32LT3175N.		0.25	0.6	mA
t_{ON}	Startup time	$V_{CC} > 6\text{V}$ to $I_{OUT} < -5\text{mA}$ (Note 4)			400	μs
I_{OUT_LIM}	Output limit current	$V_{CC} - V_{OUT} = 1\text{V}$, OUT sourcing current, ISET pin connected to GND.	-240	-205	-160	mA
I_{OUT}	Output current (Note 3)	$R_{ISET} = 15\text{k}\Omega$, $V_{CC} - V_{OUT} = 1\text{V}$, $-40^\circ\text{C} < T_J < +125^\circ\text{C}$	-105	-100	-95	mA
E_{OUT}	Absolute current accuracy (Note 3)	$-50\text{mA} \leq I_{OUT} \leq -20\text{mA}$, $V_{CC} - V_{OUT} = 1\text{V}$, $-40^\circ\text{C} < T_J < +125^\circ\text{C}$	-8		8	%
		$-150\text{mA} \leq I_{OUT} < -50\text{mA}$, $V_{CC} - V_{OUT} = 1\text{V}$, $-40^\circ\text{C} < T_J < 125^\circ\text{C}$	-6		6	%
g_{LINE}	Output current line regulation	$I_{OUT} = -50\text{mA}$, $6\text{V} < V_{CC} < 18\text{V}$, $V_{OUT} = V_{CC} - 2\text{V}$ (Note 4)	-0.2		0.2	mA/V
g_{LOAD}	Output current load regulation	$2.5\text{V} < V_{OUT} < V_{CC} - 2.0\text{V}$, $I_{OUT} = -50\text{mA}$ (Note 4)	-0.2		0.2	mA/V
t_{SL}	Current slew time	Current rise/fall between 0%~100%, $V_{TSET} = 0\text{V}$	45	70	100	μs
t_{TD_ON}	PWM current latency	Delay time between PWM rising edge to 10% of I_{OUT}		10	17	μs

IS32LT3175N/P

ELECTRICAL CHARACTERISTICS (CONTINUE)

$T_J = -40^{\circ}\text{C} \sim +125^{\circ}\text{C}$, $V_{CC}=12\text{V}$, the detail refer to each condition description. Typical values are at $T_J = 25^{\circ}\text{C}$.

Symbol	Parameter	Condition	Min.	Typ.	Max.	Unit
UVLO	Release from under voltage lock out V_{CC} voltage	V_{CC} rising release from UVLO		4.6	4.8	V
	Into under voltage lock out V_{CC} voltage	V_{CC} falling into UVLO	4.1	4.5	4.7	V
Logic Input TSET_UP, TSET_DN						
V_{TSET}	Voltage reference			1		V
T_{ACC}	Fade timing accuracy	*Neglecting the R_{TSET} Tolerance* $R_{TSET_UP}=100\text{k}\Omega$, $T_J = 25^{\circ}\text{C}$	-5		5	%
Logic Input PWM – Active High (IS32LT3175P)						
V_{IL}	Input low voltage				0.8	V
V_{IH}	Input high voltage		2			V
V_{IN_HY}	Input hysteresis	(Note 4)	150	350		mV
I_{PD}	Internal pull-down current	$V_{PWM}=12\text{V}$	15	28	46	μA
Logic Input PWM – Active Low (IS32LT3175N)						
V_{IL}	Input low voltage				0.8	V
V_{IH}	Input high voltage		2			V
V_{IN_HY}	Input hysteresis	(Note 4)	150	350		mV
I_{PU}	Internal pull-up current	$V_{PWM}=\text{GND}$	20	38	58	μA
Logic Input EN						
V_{IL}	Input low voltage				0.8	V
V_{IH}	Input high voltage		2			V
V_{IN_HY}	Input hysteresis	(Note 4)	150	350		mV
R_{PU}	Internal pull-up resistor	(Note 4)		50		$\text{k}\Omega$
I_{PU}	Internal pull-up current	$V_{EN}=0$	55	75	95	μA
t_{SW}	EN input debounce time	EN pin must not change state within this time to be interpreted as a switch press or release	25	37	50	ms
Protection						
V_{SCD}	Short detect voltage	Measured at OUT	1.2		1.8	V
V_{SCD_HY}	Short detect voltage hysteresis	Measured at OUT		220		mV
t_{FD}	Fault detect persistence time	(Note 4)		5		ms
T_{RO}	Thermal roll off threshold	(Note 4)		145		$^{\circ}\text{C}$
T_{SD}	Thermal shutdown threshold	Temperature increasing (Note 4)		175		$^{\circ}\text{C}$
T_{HY}	Over temperature hysteresis	Recovery = $T_{SHT} - T_{J_HY}$ (Note 4)		30		$^{\circ}\text{C}$

Note 1: I_{OUT} output current in case of $V_{CC}-V_{OUT}=V_{DO}$ called I_{OUT_VDO} . I_{OUT} output current in case of $V_{CC}-V_{OUT}=2\text{V}$ called I_{OUT_VDO2V} , V_{DO} accuracy is computed as $|I_{OUT_VDO}-I_{OUT_VDO2V}|/I_{OUT_VDO2V}<5\%$.

Note 2: I_{OUT} output current in case of $V_{CC}-V_{OUT}=V_{DO}$ called I_{OUT_VDO} . I_{OUT} output current in case of $V_{CC}-V_{OUT}=1\text{V}$ called I_{OUT_VDO1V} , V_{DO} accuracy is computed as $|I_{OUT_VDO}-I_{OUT_VDO1V}|/I_{OUT_VDO1V}<5\%$.

Note 3: Output current accuracy is not intended to be guaranteed at output voltages less than 1.8V.

Note 4: Guaranteed by design.

IS32LT3175N/P

TYPICAL PERFORMANCE CHARACTERISTICS

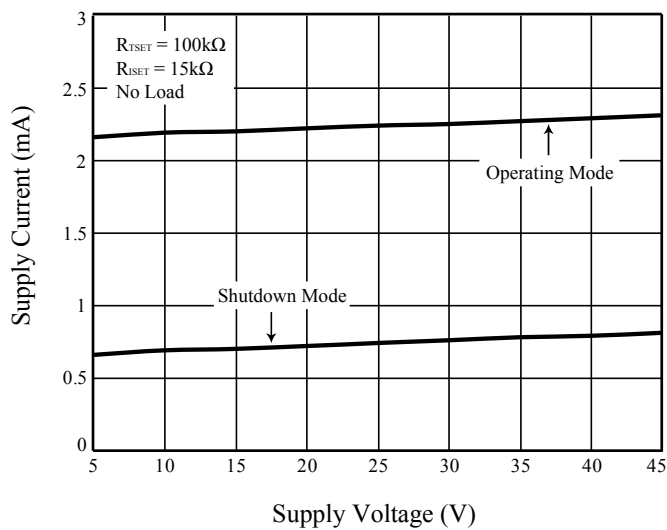

Figure 2 Supply Current vs. Supply Voltage

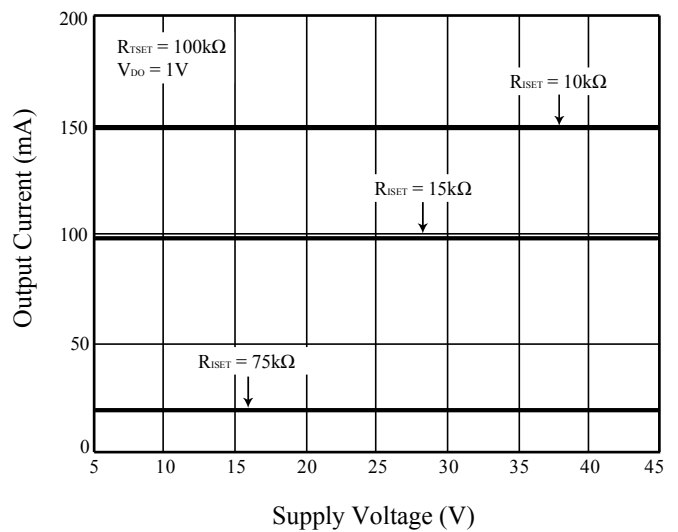

Figure 3 Output Current vs. Supply Voltage

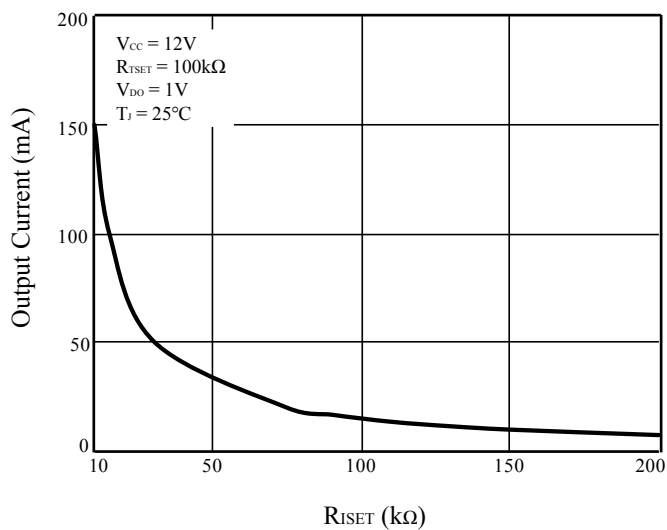

Figure 4 Output Current vs. R_{ISET}

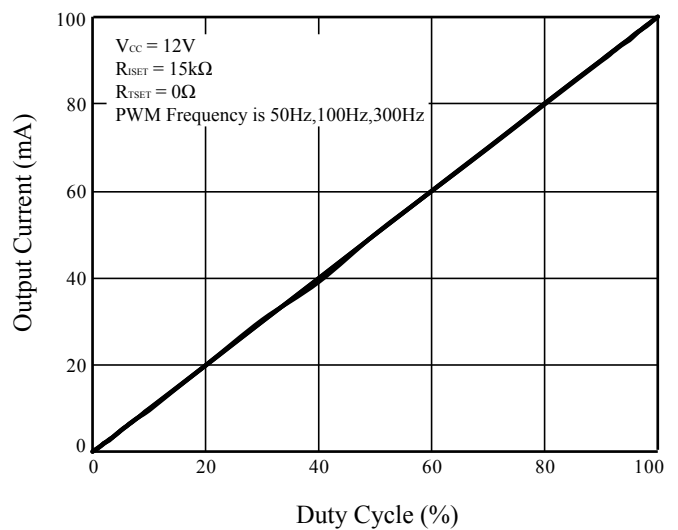

Figure 5 Output Current vs. PWM Duty Cycle

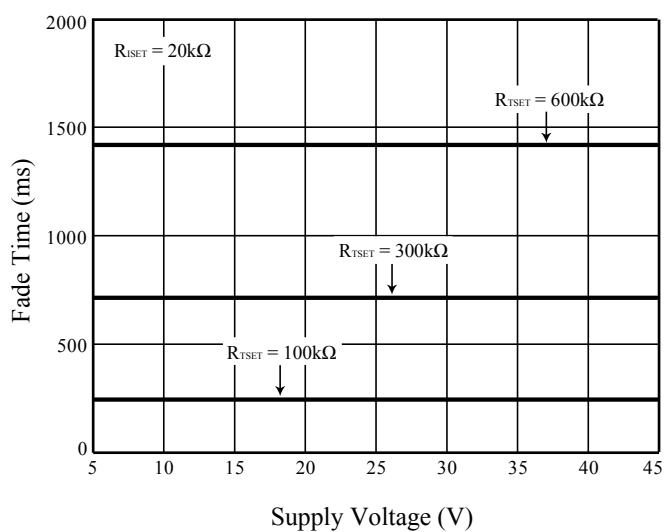

Figure 6 Fade Time vs. Supply Voltage

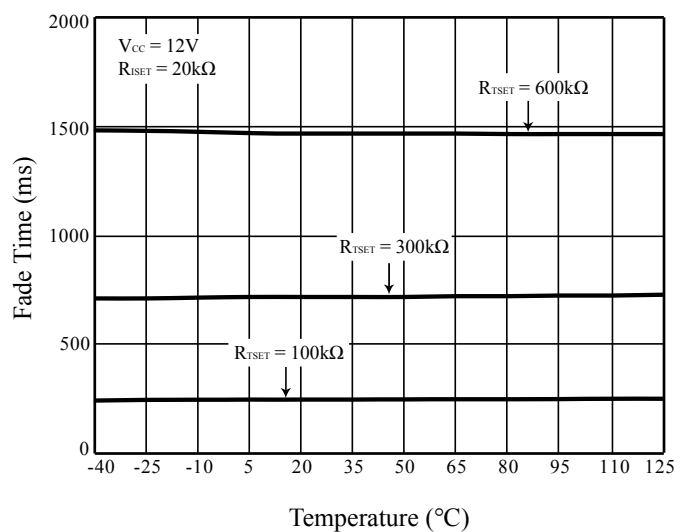

Figure 7 Fade Time vs. Temperature

IS32LT3175N/P

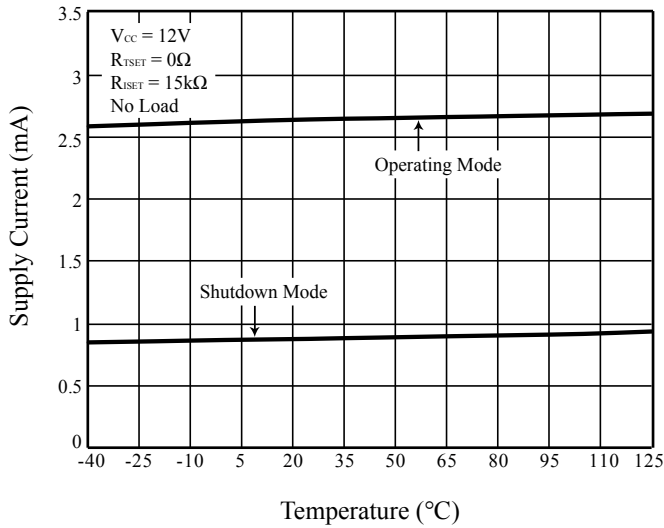

Figure 8 Supply Current vs. Temperature

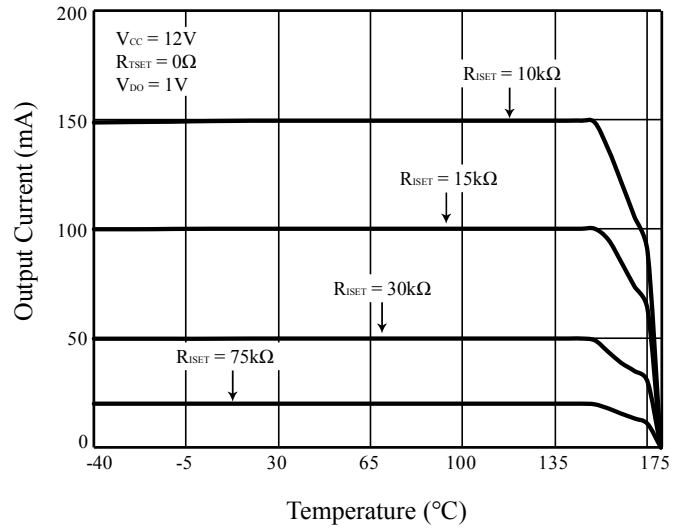

Figure 9 Output Current vs. Temperature

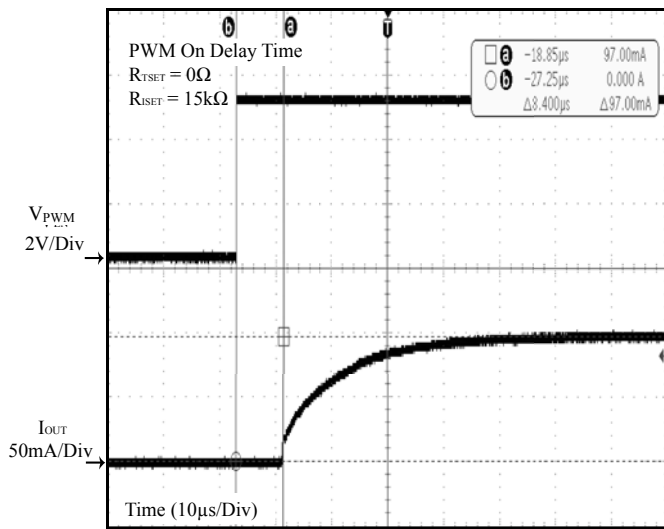

Figure 10 PWM On Delay Time (For IS32LT3175P Only)

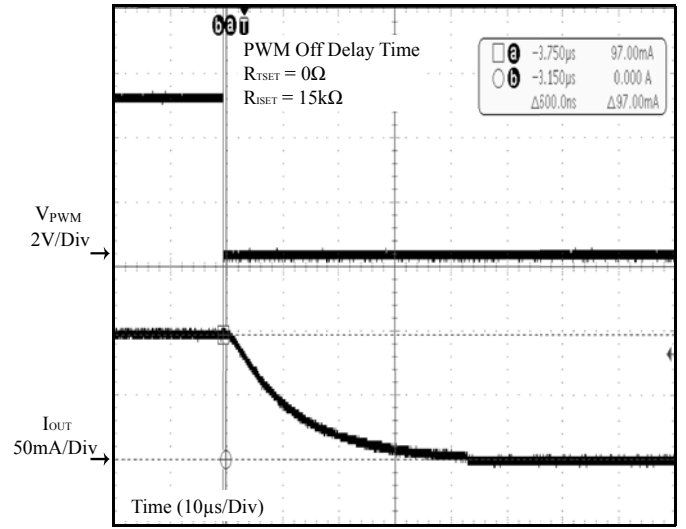

Figure 11 PWM Off Delay Time (For IS32LT3175P Only)

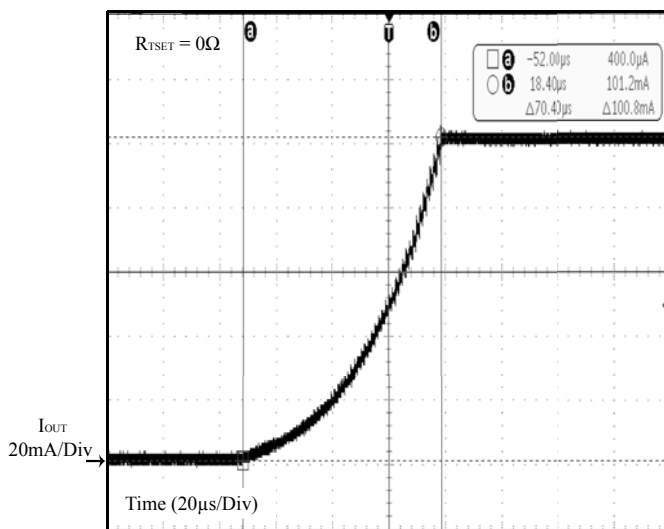

Figure 12 Instant on

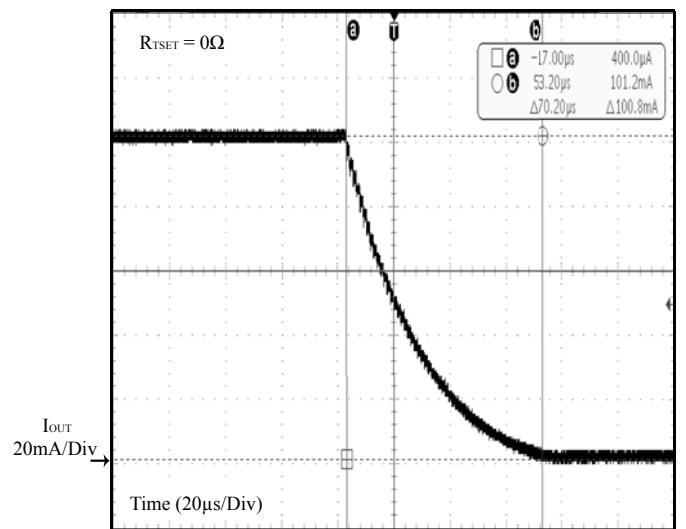

Figure 13 Instant Off

IS32LT3175N/P

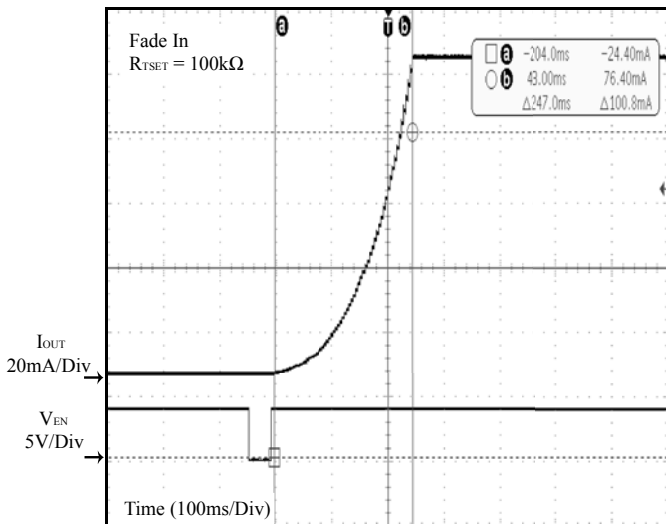

Figure 14 V_{EN} vs. I_{OUT}

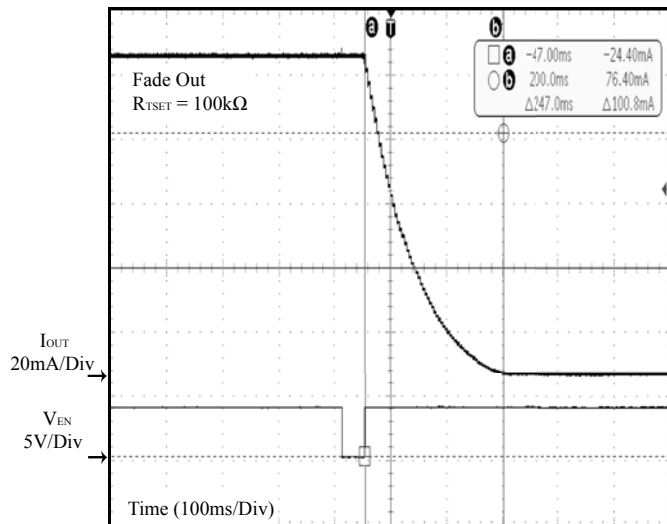

Figure 15 V_{EN} vs. I_{OUT}

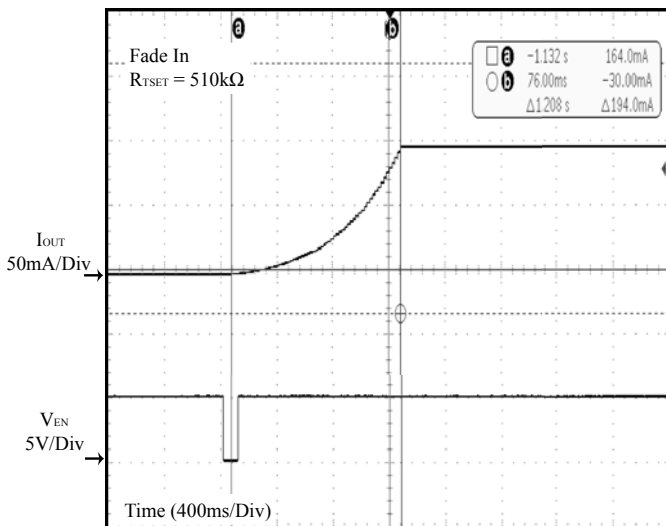

Figure 16 V_{EN} vs. I_{OUT}

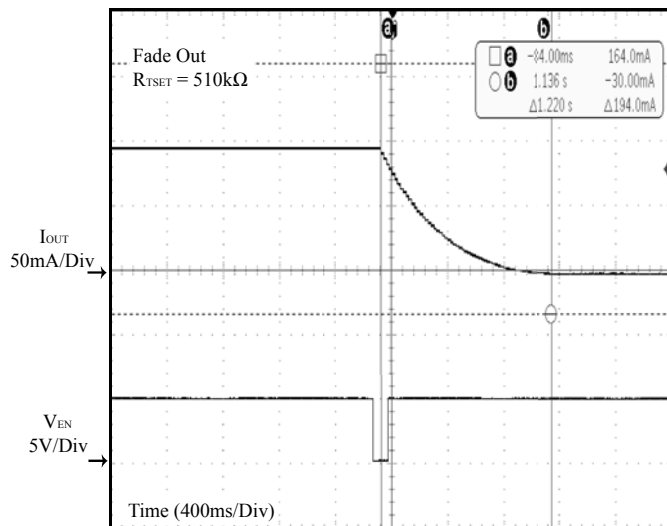

Figure 17 V_{EN} vs. I_{OUT}

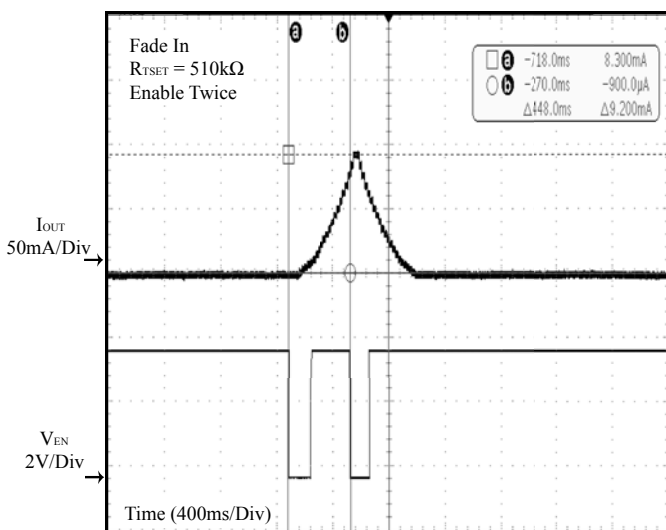

Figure 18 V_{EN} vs. I_{OUT}

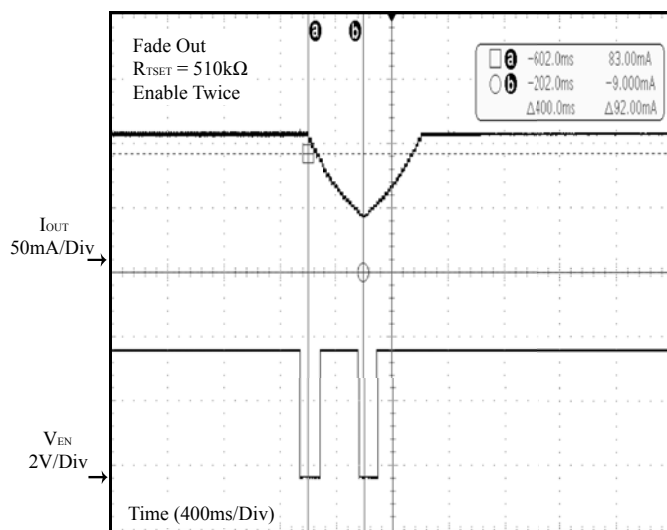

Figure 19 V_{EN} vs. I_{OUT}

IS32LT3175N/P

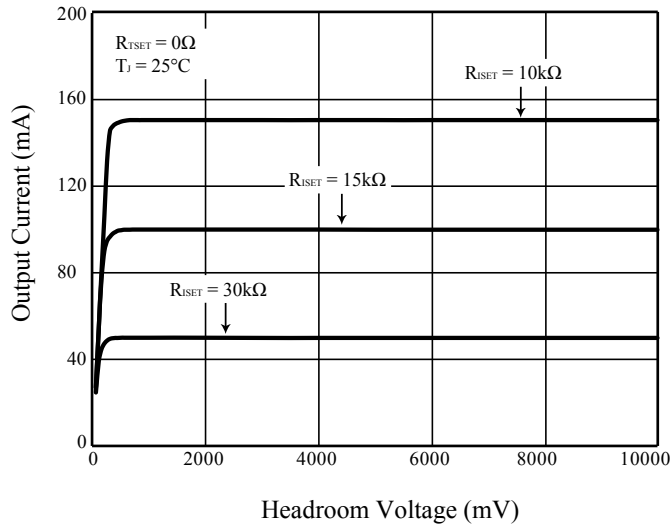
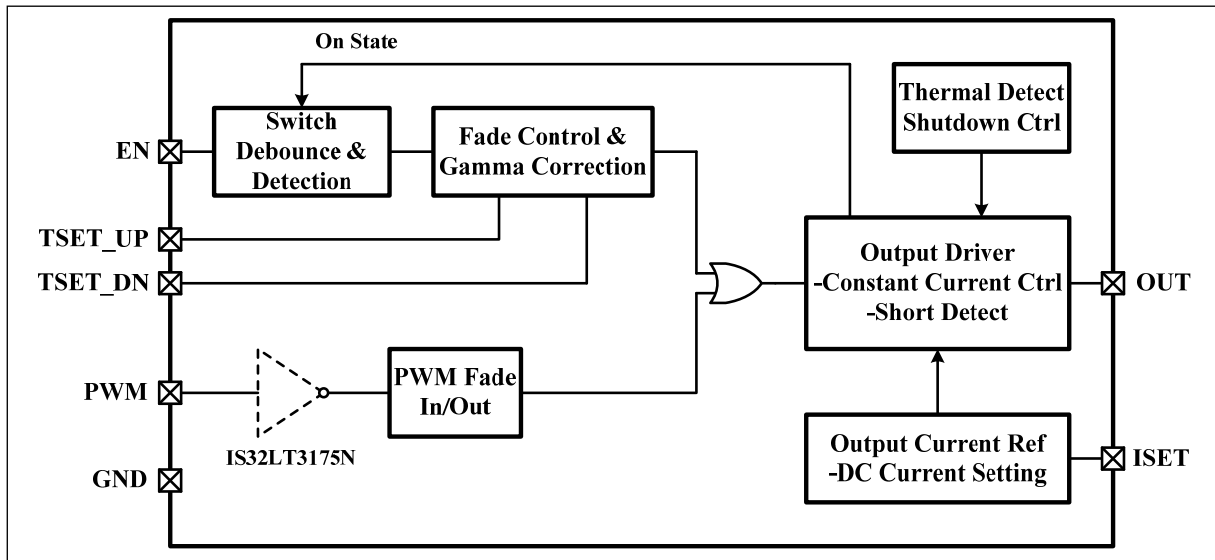

Figure 20 Output Current vs. Headroom Voltage

IS32LT3175N/P

FUNCTIONAL BLOCK DIAGRAM



Note: IS32LT3175P does not invert the PWM input.

IS32LT3175N/P

APPLICATION INFORMATION

The IS32LT3175 is a single channel linear current driver optimized to drive an automotive interior LED map light, or other interior lamp which is frequently toggled between the In and Out condition. The device integrates a debounce input circuit to enable use of a low cost momentary contact switch for controlling In/Out an external LED. In addition, a programmable fade ramp timing function provides flexibility in setting different Fade In and Fade Out ramp duration periods. The fade ramp cycle can be interrupted mid-cycle before the ramp has completed, Figure 21.

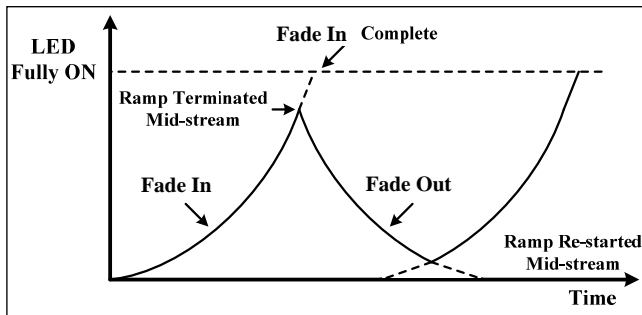

Figure 21 Fade Ramp Interrupted Mid-cycle

The regulated LED current (up to 150mA) is set by a single reference resistor (R_{ISET}).

OUTPUT CURRENT SETTING

A single programming resistor (R_{ISET}) controls the maximum output current for output channel simultaneously. The programming resistor may be computed using the following Equation (1):

$$R_{ISET} = \frac{1500}{I_{SET}} \quad (1)$$

$$(10k\Omega \leq R_{ISET} \leq 75k\Omega)$$

The device is protected from an output overcurrent condition caused by an accidental short circuit of the ISET pin, by internally limiting the maximum current in the event of an ISET short circuit to 205mA (Typ.).

EN PIN OPERATION

The EN pin has an integrated pull-up source so that no external components are required to provide the input high level to the pin.

The output channel powers up in the 'OFF' condition. Toggling the EN pin from high to low for a period of time that exceeds the debounce time will cause the output to be toggled and latched from the OFF condition to the current source condition. When this happens, the output current gradually ramps up from zero mA to the programmed value (set by R_{ISET}) over the time set by the resistor (R_{TSET_UP}) attached to the TSET_UP pin. Conversely, if it is already in the source condition, and the EN pin is toggled low, then the output current will begin to ramp down towards zero

mA in the time period as programmed by the resistor (R_{TSET_DN}) attached to the TSET_DN pin.

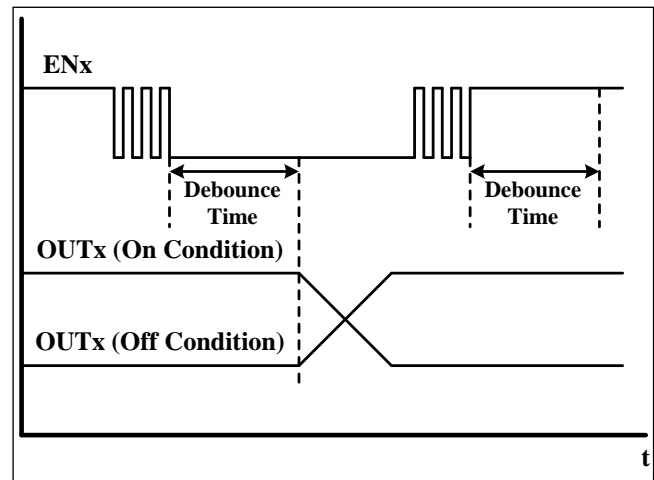

Figure 22 EN Debounced

Debounce – Output control is provided by a debounced switch input, providing an ON/OFF toggle action for various switch or button characteristics. An internal debounce circuit will condition the EN input signal so a single press of the mechanical switch doesn't appear like multiple presses. The EN input is debounced by typically 37ms.

Note: The debounce time applies to both falling and rising edges of the EN signal.

FADE IN AND FADE OUT DIMMING

The LED fade function can be accomplished in one of two methods; 1) by applying a PWM control signal to the PWM pin, or 2) when the EN pin is pulled low.

PWM Dimming – The PWM pin can be driven by an external PWM signal source to accomplish LED dimming. The integrated gamma correction and fade IN/OUT ramp functions are disabled when actively driving the PWM pin. The PWM pin input is ignored if the LED channel was previously active due to the EN pin. The EN pin will override the PWM function; it can be used to toggle the LED channel from its previous state even though the PWM pin is active.

The recommended PWM signal frequency range is 50Hz-300Hz. The duty cycle can be 0-100%. The output current of the PWM dimming is given by:

$$I_{OUT} = \frac{1500}{R_{ISET}} \times D_{PWM}$$

Where, D_{PWM} is the duty cycle of the PWM. Please refer to Figure 10 and 11 for the delay time of PWM edge to current change edge. Figure 24 and 25 show the PWM polarity difference of IS32LT3175P and IS32LT3175N.

IS32LT3175N/P

EN Dimming –The LED output current will gradually ramp up from zero to the final value as programmed by the resistor (R_{ISET}) connected to the ISET pin. The time period over which the ramping happens is determined by the resistor (R_{TSET_UP}) connected to the TSET_UP pin for Fade In time and by resistor (R_{TSET_DN}) connected to TSET_DN pin for Fade Out time. The output current will ramp up (or down) in 63 steps, with integrated gamma correction for an extremely visual linear lumen output of the LED. The ramp time can be interrupted mid-cycle each time the EN pin is pulled low.

The EN function has priority over the PWM function; if the LED has been turned on due to the EN function then the PWM dimming pin input is ignored.

UNDERVOLTAGE LOCKOUT

IS32LT3175N/P integrates an undervoltage lockout function to prevent mis-operation of the device during low input voltage conditions.

Should the VCC pin voltage fall below 4.5V (Typ.), the device will turn OFF the current source and maintain

the EN latch status as long as the VCC pin voltage remains above 3.8V. An external capacitor (Figure 23) is necessary to help maintain the VCC pin voltage $>3.8V$ and to supply current to the device status latch circuitry. However, should the voltage drop below 3.8V, the internal latch will be reset to the power on default status (LED initial off state).

The current source will be turned ON when the input voltage is re-applied and the VCC pin rises above 4.6V (Typ.).

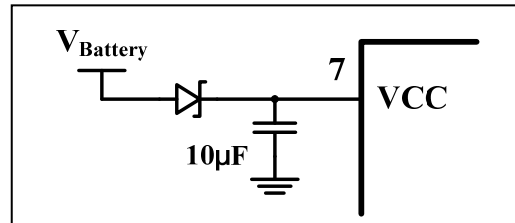

Figure 23 Capacitor For Latch Status

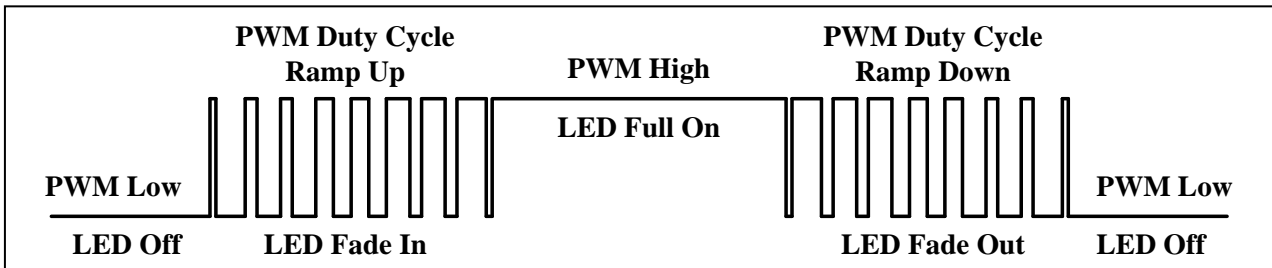

Figure 24 PWM Signal Input (Positive Polarity – IS32LT3175P)

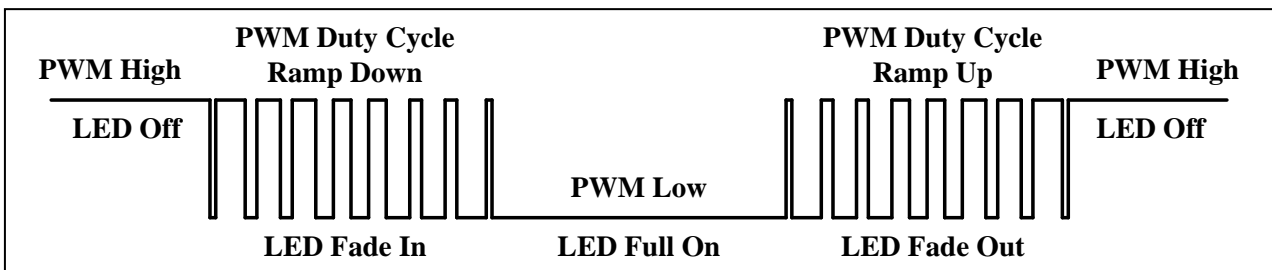

Figure 25 PWM Signal Input (Negative Polarity – IS32LT3175N)

SETTING THE FADE TIME

The fade time is set by two external programming resistors; R_{TSET_UP} and R_{TSET_DN} . The R_{TSET_UP} connected to the TSET_UP pin configures the fade ramp ON time while the R_{TSET_DN} connected to the TSET_DN pin configures the fade ramp out time. The fade time (In or Out) is programmable by Equation (2):

$$t \approx R_{TSET} \times 2.5\mu s \quad (2)$$

For example, $R_{TSET}=100k\Omega$, Fade In/Out time is about 0.25s.

Note: In order to get the optimized effect, the recommended fading time is between 1.5s ($R_{TSET}=600k\Omega$) and 0.25s ($R_{TSET}=100k\Omega$).

If either the TSET_UP or TSET_DN pin is tied directly to GND, the corresponding fade function is canceled and the ramp time is about $70\mu s$, or 'instant on'. However, the debounce feature of the EN pin is not disabled.

IS32LT3175N/P

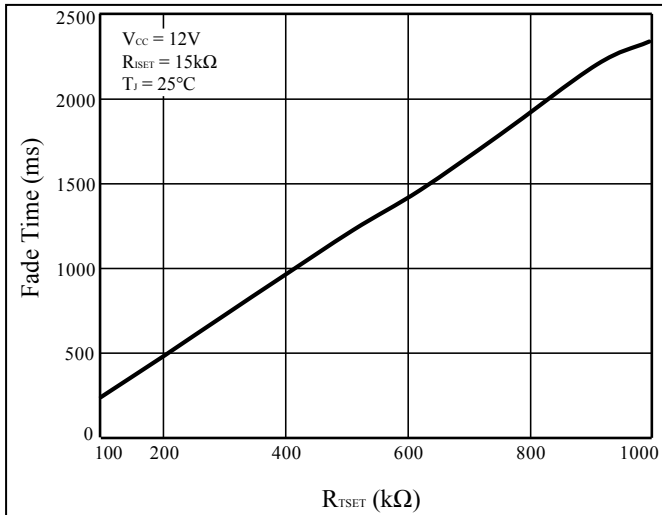

Figure 26 Fade Time vs. R_{TSET}

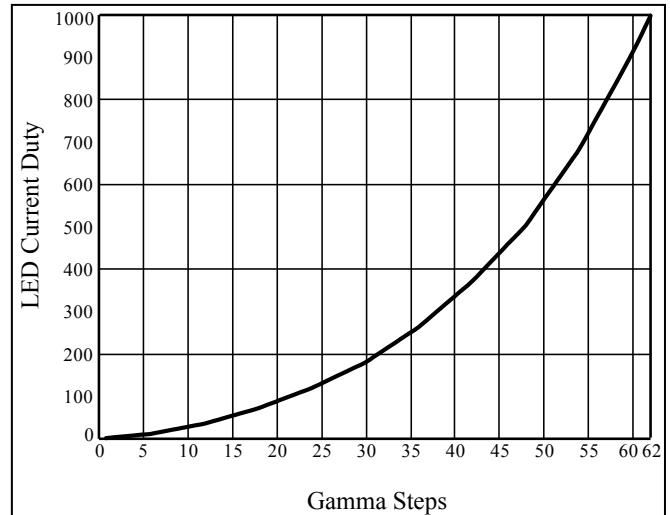

Figure 27 Gamma Correction(63 Steps)

GAMMA CORRECTION

In order to perform a better visual LED breathing effect we recommend using a gamma corrected value to set the LED intensity. This results in a reduced number of steps for the LED intensity setting, but causes the change in intensity to appear more linear to the human eye.

Gamma correction, also known as gamma compression or encoding, is used to encode linear luminance to match the non-linear characteristics of display. Gamma correction will vary the step size of the current such that the fading of the light appears linear to the human eye. Even though there may be 1000 linear steps for the fading algorithm, when gamma corrected, the actual number of steps could be as low as 63.

Table 1 63 Gamma Steps Correction

C(0)	C(1)	C(2)	C(3)	C(4)	C(5)	C(6)	C(7)
0	2	4	6	8	10	12	16
C(8)	C(9)	C(10)	C(11)	C(12)	C(13)	C(14)	C(15)
20	24	28	32	36	42	48	54
C(16)	C(17)	C(18)	C(19)	C(20)	C(21)	C(22)	C(23)
60	66	72	80	88	96	104	112
C(24)	C(25)	C(26)	C(27)	C(28)	C(29)	C(30)	C(31)
120	130	140	150	160	170	180	194
C(32)	C(33)	C(34)	C(35)	C(36)	C(37)	C(38)	C(39)
208	222	236	250	264	282	300	318
C(40)	C(41)	C(42)	C(43)	C(44)	C(45)	C(46)	C(47)
336	354	372	394	416	438	460	482
C(48)	C(49)	C(50)	C(51)	C(52)	C(53)	C(54)	C(55)
504	534	564	594	624	654	684	722
C(56)	C(57)	C(58)	C(59)	C(60)	C(61)	C(62)	
760	798	836	874	914	956	1000	

FAULT DETECTION

An output shorted to GND fault is detected if the output voltage on a channel drops below the low voltage threshold V_{SCD} and remains below the threshold for t_{FD} . The channel (OUT) with the short condition will reduce its output current to 20% of I_{SET} . When the short condition is removed, the output current will recover to original value.

When the ISET pin is shorted to GND and output current is larger than limit value, about 205mA, the output current will be clamped. Once the short fault condition is removed, the output current will recover to its original value.

OVERTEMPERATURE PROTECTION

The device features an integrated thermal rollback feature which will reduce the output current in a linear fashion if the silicon temperature exceeds 145°C (typical). In the event that the die temperature continues to increase, the device will enter thermal shutdown if the temperature exceeds 175°C.

THERMAL ROLLOFF

The output current will be equal to the set value as long as the die temperature of the IC remains below 145°C (Typical). If the die temperature exceeds this threshold, the output current of the device will begin to reduce at a rate of 3%/°C.

The roll off slope is related to ISET value. When $I_{SET}=20mA$, the roll off slope is about 3.7%. When $I_{SET}=150mA$, the roll off slope is about 2.2%.

THERMAL SHUTDOWN

In the event that the die temperature exceeds 175°C, the output channel will go to the 'OFF' state. At this point, the IC presumably begins to cool off. Any attempt to toggle the channel back to the source condition before the IC cooled to < 145°C will be blocked and the IC will not be allowed to restart.

IS32LT3175N/P

THERMAL CONSIDERATIONS

The package thermal resistance, θ_{JA} , determines the amount of heat that can pass from the silicon die to the surrounding ambient environment. The θ_{JA} is a measure of the temperature rise created by power dissipation and is usually measured in degree Celsius per watt ($^{\circ}\text{C}/\text{W}$). The junction temperature, T_J , can be calculated by the rise of the silicon temperature, ΔT , the power dissipation, P_D , and the package thermal resistance, θ_{JA} , as in Equation (3):

$$P_D = V_{CC} \times I_{CC} + (V_{CC} - V_{LED}) \times I_{OUT} \quad (3)$$

and,

$$T_J = T_A + \Delta T = T_A + P_D \times \theta_{JA} \quad (4)$$

Where I_{CC} is the IC quiescent current, V_{CC} is the supply voltage, V_{LED} is the voltage across VCC to OUT and T_A is the ambient temperature.

When operating the chip at high ambient temperatures, or when driving maximum load current, care must be taken to avoid exceeding the package power dissipation limits. The maximum power dissipation can be calculated using the following Equation (5):

$$P_{D(MAX)} = \frac{125^{\circ}\text{C} - 25^{\circ}\text{C}}{\theta_{JA}} \quad (5)$$

So,

$$P_{D(MAX)} = \frac{125^{\circ}\text{C} - 25^{\circ}\text{C}}{50.98^{\circ}\text{C}/\text{W}} \approx 1.96\text{W}$$

Figure 28, shows the power derating of the IS32LT3175 on a JEDEC board (in accordance with JESD 51-5 and JESD 51-7) standing in still air.

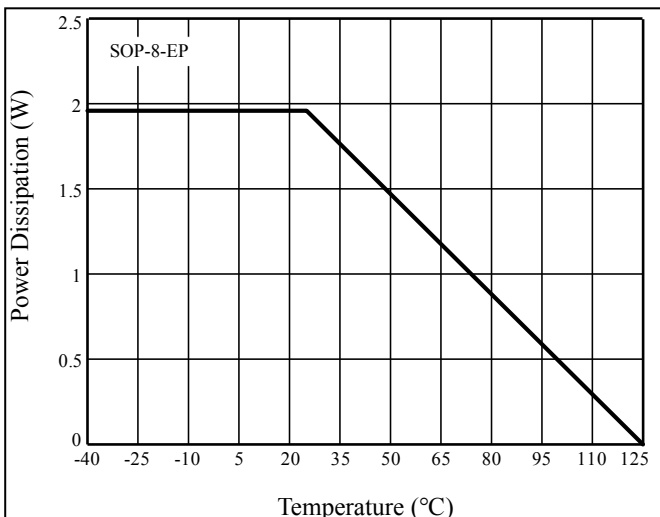

Figure 28 Dissipation Curve

The thermal resistance is achieved by mounting the IS32LT3175N/P on a standard FR4 double-sided printed circuit board (PCB) with a copper area of a few square inches on each side of the board under the IS32LT3175N/P. Multiple thermal vias, as shown in Figure 29, help to conduct the heat from the exposed pad of the IS32LT3175N/P to the copper on each side of the board. The thermal resistance can be reduced by using a metal substrate or by adding a heatsink or thicker copper plane.

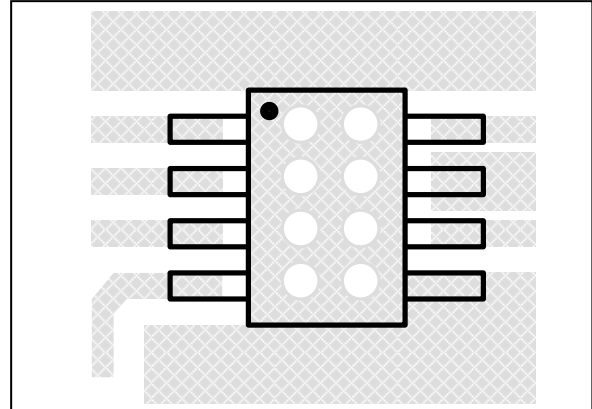

Figure 29 Board Via Layout For Thermal Dissipation

EMI AT THE CABLE AND INTERCONNECT LEVEL

Vehicle electronics can be affected by electromagnetic interference (EMI) caused by ‘stray’ magnetic and electric fields from automotive inductive load switching. Running throughout the vehicle are wiring harnesses which behave as “hidden antennas” and pickup these harmonic frequencies.

Because the IS32LT3175 is usually connected with a long wire to the vehicle’s central computer, it could be susceptible to EMI transients. For example, a coupled EMI transient on the wiring harness connected to the IS32LT3175’s PWM pin 8 can be passed through and cause a slight LED flicker.

To avoid this, an RC low-pass filter can be implemented to attenuate high frequency signals at the PWM pin. The low-pass filter will allow only low frequency signals from 0Hz to its cut-off frequency (f_c) to pass while attenuating frequencies above this cut-off frequency.

The formula to calculate the cut-off frequency of an RC filter is:

$$f_c = \frac{1}{2\pi \times R_{PWM} \times C_{PWM}} \quad (6)$$

As shown in Figure 30, typical values for $R_{PWM}=10\text{k}\Omega$ and $C_{PWM}=3.3\text{nF}$. For the IS32LT3175 the value of R_{PWM} is fixed at $10\text{k}\Omega$ (must always be installed) while C_{PWM} is optional and its value can vary depending on the vehicle’s EMI environment.

IS32LT3175N/P

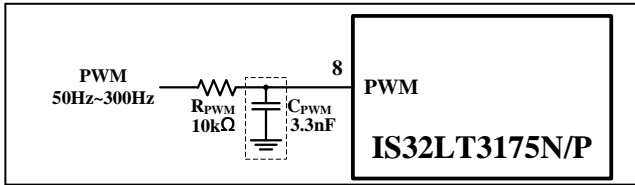

Figure 30 RC filter for PWM EMI

$$f_c = \frac{1}{2\pi \times 10k\Omega \times 3.3nF} \approx 4.7kHz$$

Frequencies above 4.7kHz will be attenuated while frequencies below 4.7kHz will pass through without attenuation.

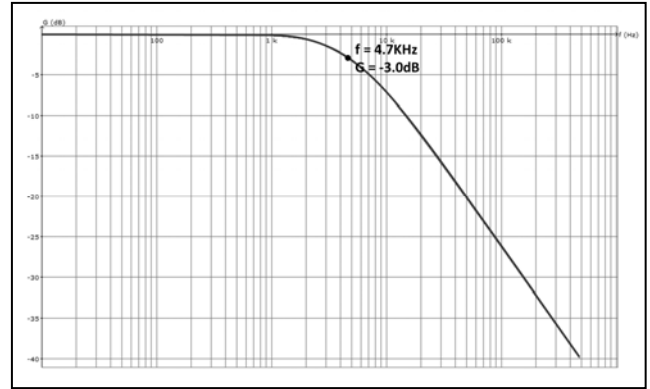

Figure 31 Low-pass filter gain-magnitude frequency response

IS32LT3175N/P

CLASSIFICATION REFLOW PROFILES

Profile Feature	Pb-Free Assembly
Preheat & Soak Temperature min (T _{smin}) Temperature max (T _{smax}) Time (T _{smin} to T _{smax}) (t _s)	150°C 200°C 60-120 seconds
Average ramp-up rate (T _{smax} to T _p)	3°C/second max.
Liquidous temperature (T _L) Time at liquidous (t _L)	217°C 60-150 seconds
Peak package body temperature (T _p)*	Max 260°C
Time (t _p)** within 5°C of the specified classification temperature (T _c)	Max 30 seconds
Average ramp-down rate (T _p to T _{smax})	6°C/second max.
Time 25°C to peak temperature	8 minutes max.

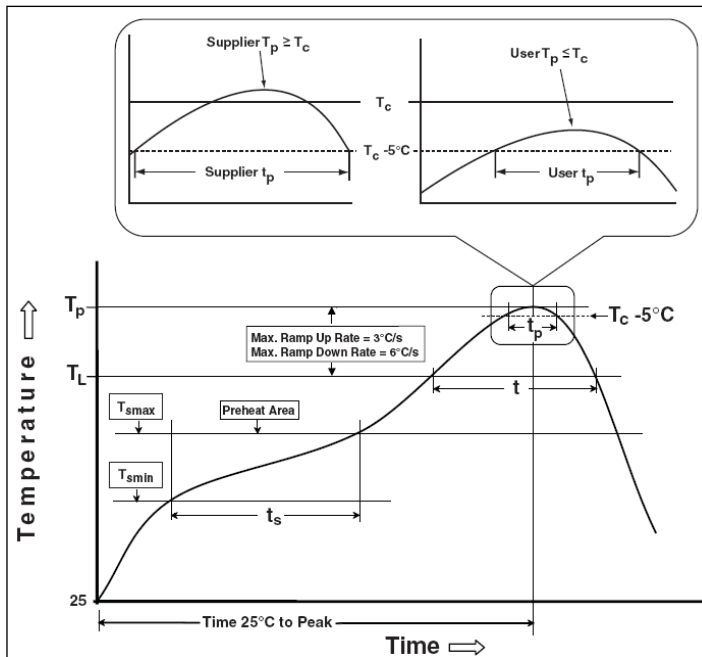
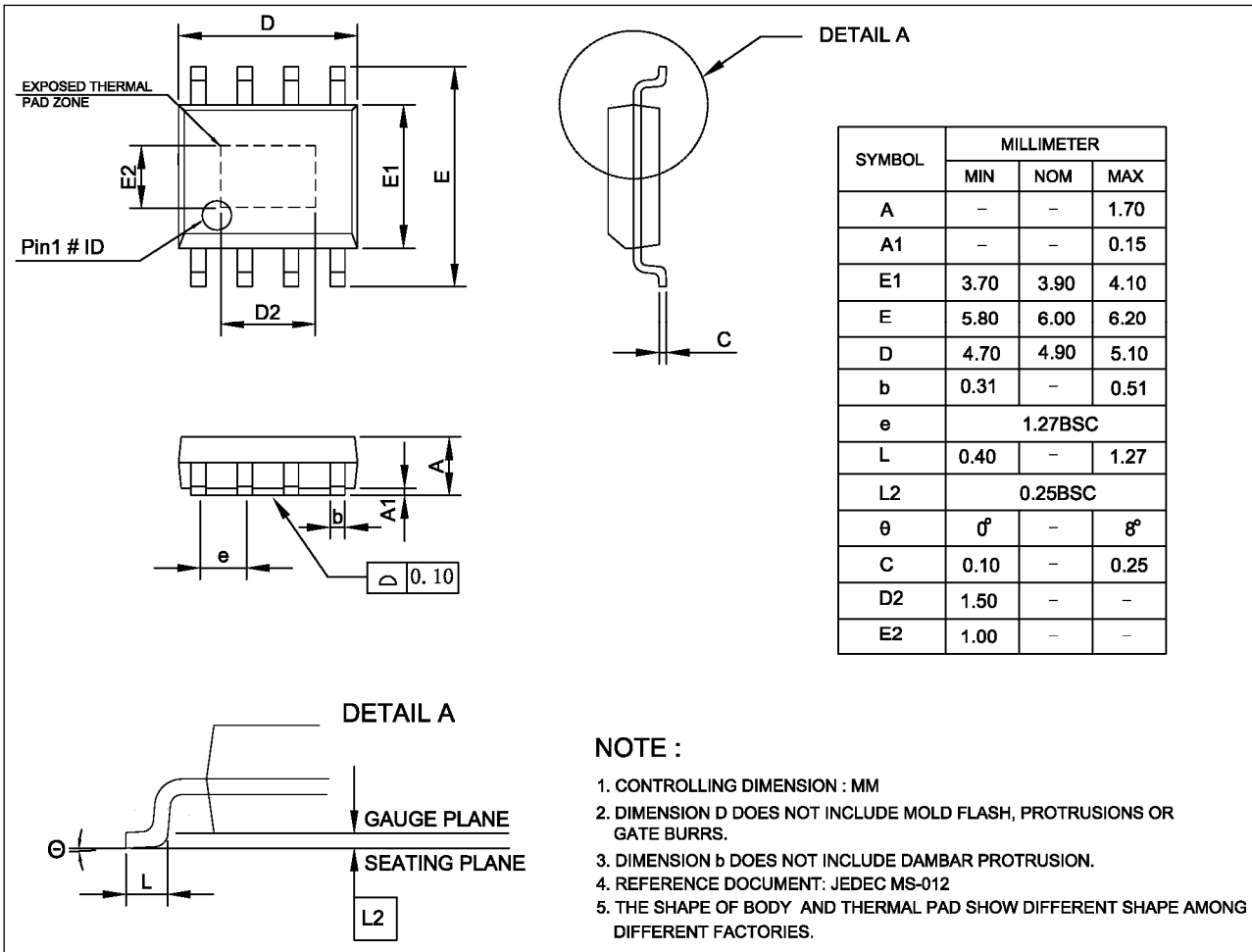

Figure 30 Classification Profile

IS32LT3175N/P

PACKAGE INFORMATION

SOP-8-EP



IS32LT3175N/P

RECOMMENDED LAND PATTERN

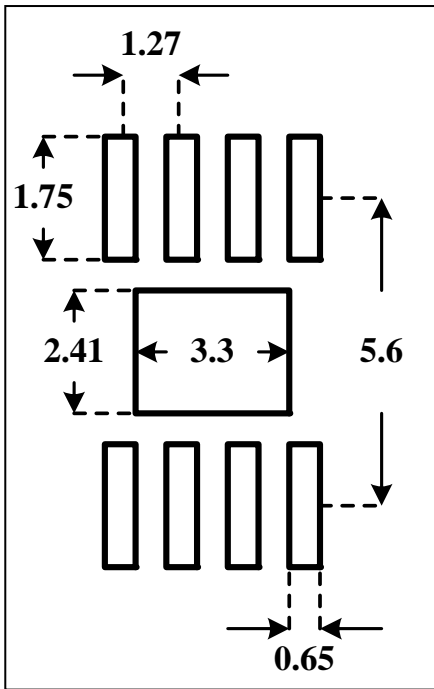

Note:

1. Land pattern complies to IPC-7351.
2. All dimensions in MM.
3. This document (including dimensions, notes & specs) is a recommendation based on typical circuit board manufacturing parameters. Since land pattern design depends on many factors unknown (eg. User's board manufacturing specs), user must determine suitability for use.

IS32LT3175N/P

REVISION HISTORY

Revision	Detail Information	Date
0A	Initial release	2016.05.04
0B	<ol style="list-style-type: none"> 1. Update typical application circuit 2. Add UVLO description 3. Update Figure 24 and 25 	2016.03.31
0C	<ol style="list-style-type: none"> 1. Update functional block 2. Update EC table 3. Update Gamma Correction section 4. Update Figure 10 and 11 5. Update Automotive Grade 	2016.05.27
A	<ol style="list-style-type: none"> 1. Update Typical Application Circuit with RC on PWM pin 2. Add description of PWM pin EMI considering 3. Update Automotive Grade 	2016.07.19

X-ON Electronics

Largest Supplier of Electrical and Electronic Components

Click to view similar products for [LED Lighting Drivers](#) category:

Click to view products by [ISSI](#) manufacturer:

Other Similar products are found below :

[LV5235V-MPB-H](#) [MB39C602PNF-G-JNEFE1](#) [MIC2871YMK-T5](#) [AL1676-10BS7-13](#) [AL1676-20AS7-13](#) [AP5726WUG-7](#) [MX877RTR](#)
[ICL8201](#) [IS31BL3228B-UTLS2-TR](#) [IS31BL3506B-TTLS2-TR](#) [AL3157F-7](#) [AP5725FDCG-7](#) [AP5726FDCG-7](#) [LV52204MTTBG](#)
[AP5725WUG-7](#) [STP4CMPQTR](#) [NCL30086BDR2G](#) [CAT4004BHU2-GT3](#) [LV52207AXA-VH](#) [AP1694AS-13](#) [TLE4242EJ](#) [AS3688](#)
[IS31LT3172-GRLS4-TR](#) [TLD2311EL](#) [KTD2694EDQ-TR](#) [KTZ8864EJAA-TR](#) [IS32LT3174-GRLA3-TR](#) [ZXLD1374QESTTC](#) [MP2488DN-](#)
[LF-Z](#) [NLM0010XTSA1](#) [AL1676-20BS7-13](#) [MPQ7220GF-AEC1-P](#) [MPQ7220GF-AEC1-Z](#) [MPQ4425BGJ-AEC1-Z](#) [IS31FL3737B-QFLS4-](#)
[TR](#) [IS31FL3239-QFLS4-TR](#) [KTD2058EUAC-TR](#) [KTD2037EWE-TR](#) [DIO5662ST6](#) [IS31BL3508A-TTLS2-TR](#) [MAX20052CATC/V+](#)
[MAX25606AUP/V+](#) [BD6586MUV-E2](#) [BD9206EFV-E2](#) [BD9416FS-E2](#) [LYT4227E](#) [LYT6079C-TL](#) [MP3394SGF-P](#) [MP4689AGN-P](#)
[MPQ4425AGQB-AEC1-Z](#)