

512K x36 and 1024K x18 18Mb, PIPELINE 'NO WAIT' STATE BUS SYNCHRONOUS SRAM

AUGUST 2019

FEATURES

- 100 percent bus utilization
- No wait cycles between Read and Write
- Internal self-timed write cycle
- Individual Byte Write Control
- Single R/W (Read/Write) control pin
- Clock controlled, registered address, data and control
- Interleaved or linear burst sequence control using MODE input
- Three chip enables for simple depth expansion and address pipelining
- Power Down mode
- Common data inputs and data outputs
- /CKE pin to enable clock and suspend operation
- JEDEC 100-pin QFP, 165-ball BGA and 119-ball BGA packages
- Power supply:
 NLP: V_{DD} 3.3V ($\pm 5\%$), V_{DDQ} 3.3V/2.5V ($\pm 5\%$)
 NVP: V_{DD} 2.5V ($\pm 5\%$), V_{DDQ} 2.5V ($\pm 5\%$)
 NVVP: V_{DD} 1.8V ($\pm 5\%$), V_{DDQ} 1.8V ($\pm 5\%$)
- JTAG Boundary Scan for BGA packages
- Commercial, Industrial and Automotive (x36) temperature support
- Lead-free available
- For leaded option, please contact ISSI.

DESCRIPTION

The 18Meg product family features high-speed, low-power synchronous static RAMs designed to provide a burstable, high-performance, 'no wait' state, device for networking and communications applications. They are organized as 512K words by 36 bits and 1024K words by 18 bits, fabricated with ISSI's advanced CMOS technology.

Incorporating a 'no wait' state feature, wait cycles are eliminated when the bus switches from read to write, or write to read. This device integrates a 2-bit burst counter, high-speed SRAM core, and high-drive capability outputs into a single monolithic circuit.

All synchronous inputs pass through registers are controlled by a positive-edge-triggered single clock input. Operations may be suspended and all synchronous inputs ignored when Clock Enable, /CKE is HIGH. In this state the internal device will hold their previous values.

All Read, Write and Deselect cycles are initiated by the ADV input. When the ADV is HIGH the internal burst counter is incremented. New external addresses can be loaded when ADV is LOW. Write cycles are internally self-timed and are initiated by the rising edge of the clock inputs and when /WE is LOW. Separate byte enables allow individual bytes to be written.

A burst mode pin (MODE) defines the order of the burst sequence. When tied HIGH, the interleaved burst sequence is selected. When tied LOW, the linear burst sequence is selected.

FAST ACCESS TIME

Symbol	Parameter	-250	-200	Units
tKQ	Clock Access Time	2.6	3.0	ns
tKC	Cycle time	4	5	ns
	Frequency	250	200	MHz

Copyright © 2019 Integrated Silicon Solution, Inc. All rights reserved. ISSI reserves the right to make changes to this specification and its products at any time without notice. ISSI assumes no liability arising out of the application or use of any information, products or services described herein. Customers are advised to obtain the latest version of this device specification before relying on any published information and before placing orders for products.

Integrated Silicon Solution, Inc. does not recommend the use of any of its products in life support applications where the failure or malfunction of the product can reasonably be expected to cause failure of the life support system or to significantly affect its safety or effectiveness. Products are not authorized for use in such applications unless Integrated Silicon Solution, Inc. receives written assurance to its satisfaction, that:

- a.) the risk of injury or damage has been minimized;
- b.) the user assume all such risks; and
- c.) potential liability of Integrated Silicon Solution, Inc is adequately protected under the circumstances

BLOCK DIAGRAM

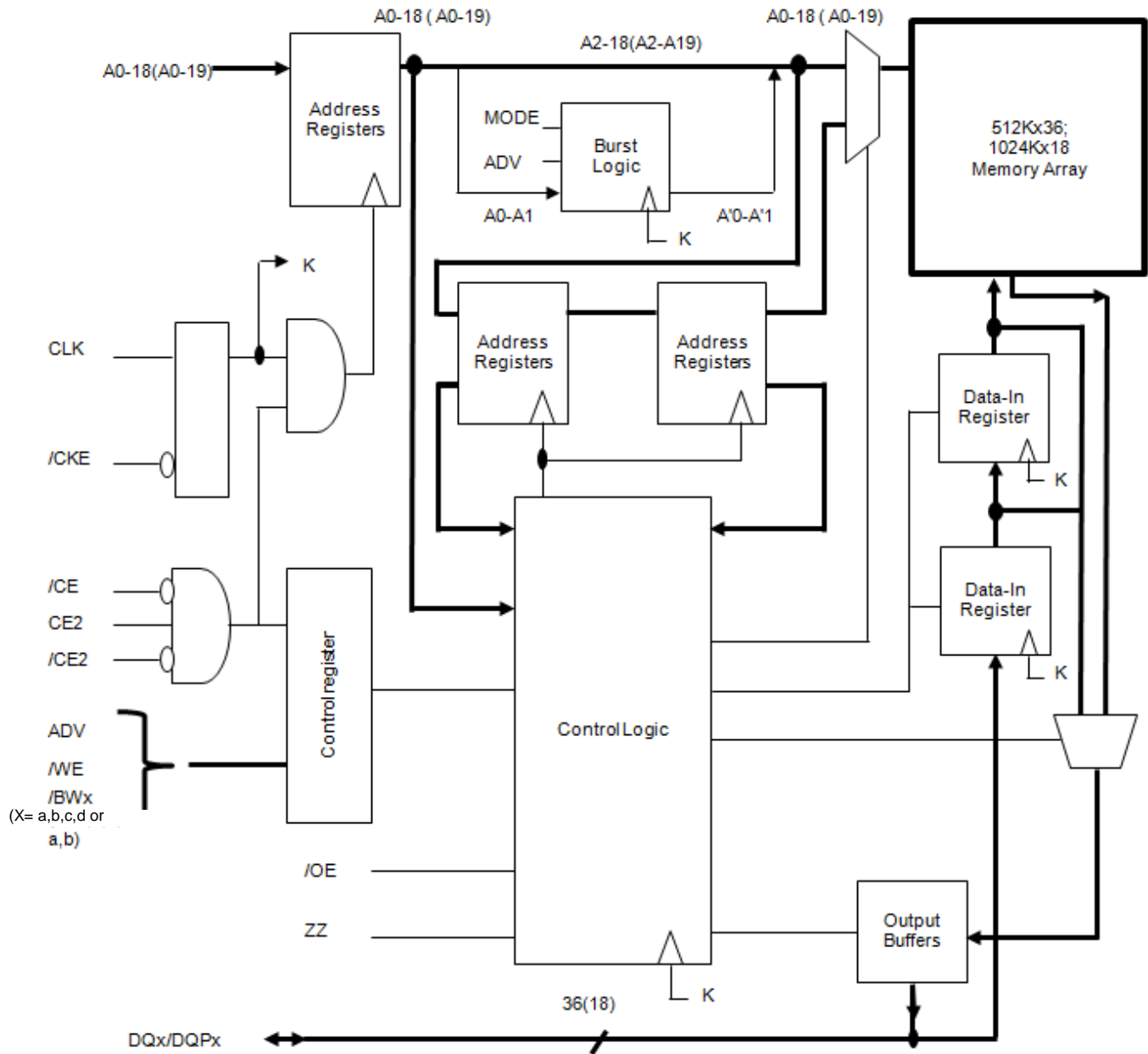

PIN CONFIGURATION

512K x 36, 165-Ball BGA (Top View)

	1	2	3	4	5	6	7	8	9	10	11
A	NC	A	/CE	/BWc	/BWb	/CE2	/CKE	ADV	A	A	NC
B	NC	A	CE2	/BWd	/BWa	CLK	/WE	/OE	A	A	NC
C	DQPc	NC	V _{DDQ}	V _{SS}	V _{SS}	V _{SS}	V _{SS}	V _{SS}	V _{DDQ}	NC	DQPb
D	DQc	DQc	V _{DDQ}	V _{DD}	V _{SS}	V _{SS}	V _{SS}	V _{DD}	V _{DDQ}	DQb	DQb
E	DQc	DQc	V _{DDQ}	V _{DD}	V _{SS}	V _{SS}	V _{SS}	V _{DD}	V _{DDQ}	DQb	DQb
F	DQc	DQc	V _{DDQ}	V _{DD}	V _{SS}	V _{SS}	V _{SS}	V _{DD}	V _{DDQ}	DQb	DQb
G	DQc	DQc	V _{DDQ}	V _{DD}	V _{SS}	V _{SS}	V _{SS}	V _{DD}	V _{DDQ}	DQb	DQb
H	NC	NC	NC	V _{DD}	V _{SS}	V _{SS}	V _{SS}	V _{DD}	NC	NC	ZZ
J	DQd	DQd	V _{DDQ}	V _{DD}	V _{SS}	V _{SS}	V _{SS}	V _{DD}	V _{DDQ}	DQa	DQa
K	DQd	DQd	V _{DDQ}	V _{DD}	V _{SS}	V _{SS}	V _{SS}	V _{DD}	V _{DDQ}	DQa	DQa
L	DQd	DQd	V _{DDQ}	V _{DD}	V _{SS}	V _{SS}	V _{SS}	V _{DD}	V _{DDQ}	DQa	DQa
M	DQd	DQd	V _{DDQ}	V _{DD}	V _{SS}	V _{SS}	V _{SS}	V _{DD}	V _{DDQ}	DQa	DQa
N	DQPd	NC	V _{DDQ}	V _{SS}	NC	NC	NC	V _{SS}	V _{DDQ}	NC	DQPa
P	NC	NC	A	A	TDI	A1*	TDO	A	A	A	NC
R	MODE	NC	A	A	TMS	A0*	TCK	A	A	A	A

Note: A0 and A1 are the two least significant bits (LSB) of the address field and set the internal burst counter if burst is desired.

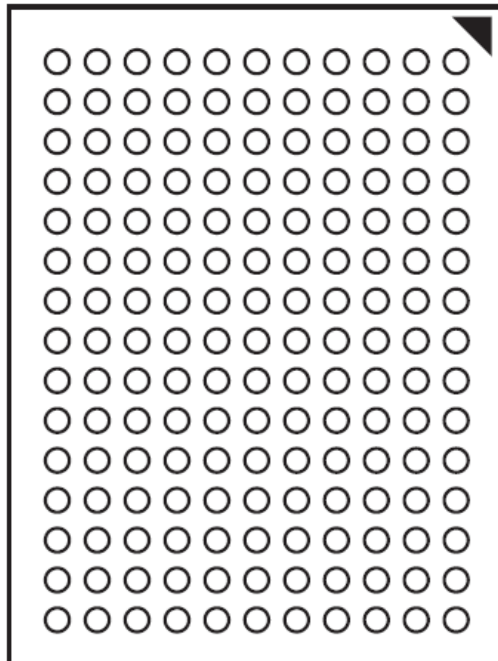

Bottom View
 165-Ball, 13 mm x 15mm BGA

PIN DESCRIPTIONS

Symbol	Pin Name
CLK	Synchronous Clock
/CKE	Clock Enable
A0,A1	Synchronous Burst Address Inputs
A	Address Inputs
ADV	Synchronous Burst Address Advance/Load
MODE	Burst Sequence Selection
/CE,CE2,/CE2	Synchronous Chip Enable
/WE	Synchronous Read/Write Control Input
/BWx (x=a-d)	Synchronous Byte Write Inputs
/OE	Output Enable
DQx	Data Inputs/Outputs
DQPx	Parity Data I/O
TCK,TDI, TDO,TMS	JTAG Pins
ZZ	Power Sleep Mode
NC	No Connect
V _{DD}	Power Supply
V _{DDQ}	I/O Power Supply
V _{SS}	Ground

512K x 32, 165-Ball BGA (Top View)

	1	2	3	4	5	6	7	8	9	10	11
A	NC	A	/CE	/BWc	/BWb	/CE2	/CKE	ADV	A	A	NC
B	NC	A	CE2	/BWd	/BWa	CLK	/WE	/OE	A	A	NC
C	NC	NC	V _{DDQ}	V _{SS}	V _{SS}	V _{SS}	V _{SS}	V _{SS}	V _{DDQ}	NC	NC
D	DQc	DQc	V _{DDQ}	V _{DD}	V _{SS}	V _{SS}	V _{SS}	V _{DD}	V _{DDQ}	DQb	DQb
E	DQc	DQc	V _{DDQ}	V _{DD}	V _{SS}	V _{SS}	V _{SS}	V _{DD}	V _{DDQ}	DQb	DQb
F	DQc	DQc	V _{DDQ}	V _{DD}	V _{SS}	V _{SS}	V _{SS}	V _{DD}	V _{DDQ}	DQb	DQb
G	DQc	DQc	V _{DDQ}	V _{DD}	V _{SS}	V _{SS}	V _{SS}	V _{DD}	V _{DDQ}	DQb	DQb
H	NC	NC	NC	V _{DD}	V _{SS}	V _{SS}	V _{SS}	V _{DD}	NC	NC	ZZ
J	DQd	DQd	V _{DDQ}	V _{DD}	V _{SS}	V _{SS}	V _{SS}	V _{DD}	V _{DDQ}	DQa	DQa
K	DQd	DQd	V _{DDQ}	V _{DD}	V _{SS}	V _{SS}	V _{SS}	V _{DD}	V _{DDQ}	DQa	DQa
L	DQd	DQd	V _{DDQ}	V _{DD}	V _{SS}	V _{SS}	V _{SS}	V _{DD}	V _{DDQ}	DQa	DQa
M	DQd	DQd	V _{DDQ}	V _{DD}	V _{SS}	V _{SS}	V _{SS}	V _{DD}	V _{DDQ}	DQa	DQa
N	NC	NC	V _{DDQ}	V _{SS}	NC	NC	NC	V _{SS}	V _{DDQ}	NC	NC
P	NC	NC	A	A	TDI	A1*	TDO	A	A	A	NC
R	MODE	NC	A	A	TMS	A0*	TCK	A	A	A	A

Note: A0 and A1 are the two least significant bits (LSB) of the address field and set the internal burst counter if burst is desired.

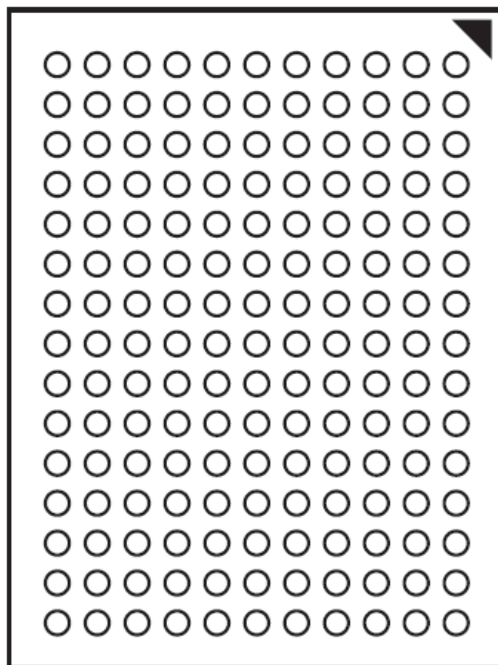

Bottom View
 165-Ball, 13 mm x 15mm BGA

PIN DESCRIPTIONS

Symbol	Pin Name
CLK	Synchronous Clock
/CKE	Clock Enable
A0,A1	Synchronous Burst Address Inputs
A	Address Inputs
ADV	Synchronous Burst Address Advance/Load
MODE	Burst Sequence Selection
/CE,CE2,/CE2	Synchronous Chip Enable
/WE	Synchronous Read/Write Control Input
/BWx (x=a-d)	Synchronous Byte Write Inputs
/OE	Output Enable
DQx	Data Inputs/Outputs
TCK,TDI, TDO,TMS	JTAG Pins
ZZ	Power Sleep Mode
NC	No Connect
V _{DD}	Power Supply
V _{DDQ}	I/O Power Supply
V _{SS}	Ground

1024K x 18, 165-Ball BGA (Top View)

	1	2	3	4	5	6	7	8	9	10	11
A	NC	A	/CE	/BWb	NC	/CE2	/CKE	ADV	A	A	A
B	NC	A	CE2	NC	/BWa	CLK	/WE	/OE	A	A	NC
C	NC	NC	V _{DDQ}	V _{SS}	V _{SS}	V _{SS}	V _{SS}	V _{SS}	V _{DDQ}	NC	DQP _a
D	NC	DQb	V _{DDQ}	V _{DD}	V _{SS}	V _{SS}	V _{SS}	V _{DD}	V _{DDQ}	NC	DQ _a
E	NC	DQb	V _{DDQ}	V _{DD}	V _{SS}	V _{SS}	V _{SS}	V _{DD}	V _{DDQ}	NC	DQ _a
F	NC	DQb	V _{DDQ}	V _{DD}	V _{SS}	V _{SS}	V _{SS}	V _{DD}	V _{DDQ}	NC	DQ _a
G	NC	DQb	V _{DDQ}	V _{DD}	V _{SS}	V _{SS}	V _{SS}	V _{DD}	V _{DDQ}	NC	DQ _a
H	NC	NC	NC	V _{DD}	V _{SS}	V _{SS}	V _{SS}	V _{DD}	NC	NC	ZZ
J	DQb	NC	V _{DDQ}	V _{DD}	V _{SS}	V _{SS}	V _{SS}	V _{DD}	V _{DDQ}	DQ _a	NC
K	DQb	NC	V _{DDQ}	V _{DD}	V _{SS}	V _{SS}	V _{SS}	V _{DD}	V _{DDQ}	DQ _a	NC
L	DQb	NC	V _{DDQ}	V _{DD}	V _{SS}	V _{SS}	V _{SS}	V _{DD}	V _{DDQ}	DQ _a	NC
M	DQb	NC	V _{DDQ}	V _{DD}	V _{SS}	V _{SS}	V _{SS}	V _{DD}	V _{DDQ}	DQ _a	NC
N	DQP _b	NC	V _{DDQ}	V _{SS}	NC	NC	NC	V _{SS}	V _{DDQ}	NC	NC
P	NC	NC	A	A	TDI	A1*	TDO	A	A	A	NC
R	MODE	NC	A	A	TMS	A0*	TCK	A	A	A	A

Note: A0 and A1 are the two least significant bits (LSB) of the address field and set the internal burst counter if burst is desired.



Bottom View
 165-Ball, 13 mm x 15mm BGA

PIN DESCRIPTIONS

Symbol	Pin Name
CLK	Synchronous Clock
/CKE	Clock Enable
A0,A1	Synchronous Burst Address Inputs
A	Address Inputs
ADV	Synchronous Burst Address Advance/Load
MODE	Burst Sequence Selection
/CE,CE2,/CE2	Synchronous Chip Enable
/WE	Synchronous Read/Write Control Input
/BW _x (x=a-b)	Synchronous Byte Write Inputs
/OE	Output Enable
DQ _x	Data Inputs/Outputs
DQP _x	Parity Data I/O
TCK,TDI, TDO,TMS	JTAG Pins
ZZ	Power Sleep Mode
NC	No Connect
V _{DD}	Power Supply
V _{DDQ}	I/O Power Supply
V _{SS}	Ground

512K x 36, 119-Ball BGA (Top View)

	1	2	3	4	5	6	7
A	V _{DDQ}	A	A	A	A	A	V _{DDQ}
B	NC	CE2	A	ADV	A	/CE2	NC
C	NC	A	A	V _{DD}	A	A	NC
D	DQc	DQPc	V _{SS}	NC	V _{SS}	DQPb	DQb
E	DQc	DQc	V _{SS}	/CE	V _{SS}	DQb	DQb
F	V _{DDQ}	DQc	V _{SS}	/OE	V _{SS}	DQb	V _{DDQ}
G	DQc	DQc	/BWc	A	/BWb	DQb	DQb
H	DQc	DQc	V _{SS}	/WE	V _{SS}	DQb	DQb
J	V _{DDQ}	V _{DD}	NC	V _{DD}	NC	V _{DD}	V _{DDQ}
K	DQd	DQd	V _{SS}	CLK	V _{SS}	DQa	DQa
L	DQd	DQd	/BWd	NC	/BWa	DQa	DQa
M	V _{DDQ}	DQd	V _{SS}	/CKE	V _{SS}	DQa	V _{DDQ}
N	DQd	DQd	V _{SS}	A1*	V _{SS}	DQa	DQa
P	DQd	DQPd	V _{SS}	A0*	V _{SS}	DQPa	DQa
R	NC	A	MODE	V _{DD}	NC	A	NC
T	NC	NC	A	A	A	NC	ZZ
U	V _{DDQ}	TMS	TDI	TCK	TDO	NC	V _{DDQ}

Note: A0 and A1 are the two least significant bits (LSB) of the address field and set the internal burst counter if burst is desired.

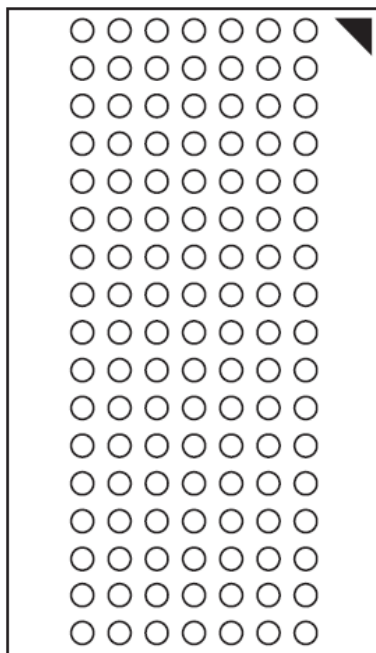

Bottom View
 119-Ball, 14 mm x 22 mm BGA

PIN DESCRIPTIONS

Symbol	Pin Name
CLK	Synchronous Clock
/CKE	Clock Enable
A0,A1	Synchronous Burst Address Inputs
A	Address Inputs
ADV	Synchronous Burst Address Advance/Load
MODE	Burst Sequence Selection
/CE,CE2,/CE2	Synchronous Chip Enable
/WE	Synchronous Read/Write Control Input
/BWx (x=a-d)	Synchronous Byte Write Inputs
/OE	Output Enable
DQx	Data Inputs/Outputs
DQPx	Parity Data I/O
TCK,TDI, TDO,TMS	JTAG Pins
ZZ	Power Sleep Mode
NC	No Connect
V _{DD}	Power Supply
V _{DDQ}	I/O Power Supply
V _{SS}	Ground

512K x 32, 119-Ball BGA (Top View)

	1	2	3	4	5	6	7
A	V _{DDQ}	A	A	A	A	A	V _{DDQ}
B	NC	CE2	A	ADV	A	/CE2	NC
C	NC	A	A	V _{DD}	A	A	NC
D	DQc	NC	V _{SS}	NC	V _{SS}	NC	DQb
E	DQc	DQc	V _{SS}	/CE	V _{SS}	DQb	DQb
F	V _{DDQ}	DQc	V _{SS}	/OE	V _{SS}	DQb	V _{DDQ}
G	DQc	DQc	/BWc	A	/BWb	DQb	DQb
H	DQc	DQc	V _{SS}	/WE	V _{SS}	DQb	DQb
J	V _{DDQ}	V _{DD}	NC	V _{DD}	NC	V _{DD}	V _{DDQ}
K	DQd	DQd	V _{SS}	CLK	V _{SS}	DQa	DQa
L	DQd	DQd	/BWd	NC	/BWa	DQa	DQa
M	V _{DDQ}	DQd	V _{SS}	/CKE	V _{SS}	DQa	V _{DDQ}
N	DQd	DQd	V _{SS}	A1*	V _{SS}	DQa	DQa
P	DQd	NC	V _{SS}	A0*	V _{SS}	NC	DQa
R	NC	A	MODE	V _{DD}	NC	A	NC
T	NC	NC	A	A	A	NC	ZZ
U	V _{DDQ}	TMS	TDI	TCK	TDO	NC	V _{DDQ}

Note: A0 and A1 are the two least significant bits (LSB) of the address field and set the internal burst counter if burst is desired.

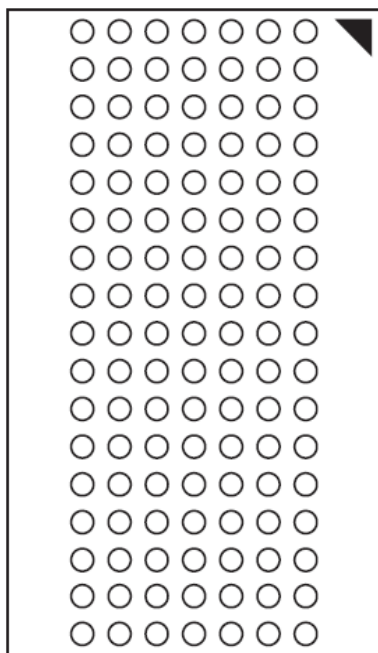

Bottom View
 119-Ball, 14 mm x 22 mm BGA

PIN DESCRIPTIONS

Symbol	Pin Name
CLK	Synchronous Clock
/CKE	Clock Enable
A0,A1	Synchronous Burst Address Inputs
A	Address Inputs
ADV	Synchronous Burst Address Advance/Load
MODE	Burst Sequence Selection
/CE,CE2,/CE2	Synchronous Chip Enable
/WE	Synchronous Read/Write Control Input
/BWx (x=a-d)	Synchronous Byte Write Inputs
/OE	Output Enable
DQx	Data Inputs/Outputs
TCK,TDI, TDO,TMS	JTAG Pins
ZZ	Power Sleep Mode
NC	No Connect
V _{DD}	Power Supply
V _{DDQ}	I/O Power Supply
V _{SS}	Ground

1024K x 18, 119-Ball BGA (Top View)

	1	2	3	4	5	6	7
A	V _{DDQ}	A	A	A	A	A	V _{DDQ}
B	NC	CE2	A	ADV	A	/CE2	NC
C	NC	A	A	V _{DD}	A	A	NC
D	DQb	NC	V _{SS}	NC	V _{SS}	DQP _a	NC
E	NC	DQb	V _{SS}	/CE	V _{SS}	NC	DQ _a
F	V _{DDQ}	NC	V _{SS}	/OE	V _{SS}	DQ _a	V _{DDQ}
G	NC	DQb	/BW _b	A	NC	NC	DQ _a
H	DQb	NC	V _{SS}	/WE	V _{SS}	DQ _a	NC
J	V _{DDQ}	V _{DD}	NC	V _{DD}	NC	V _{DD}	V _{DDQ}
K	NC	DQb	V _{SS}	CLK	V _{SS}	NC	DQ _a
L	DQb	NC	NC	NC	/BW _a	DQ _a	NC
M	V _{DDQ}	DQb	V _{SS}	/CKE	V _{SS}	NC	V _{DDQ}
N	DQb	NC	V _{SS}	A1*	V _{SS}	DQ _a	NC
P	NC	DQP _b	V _{SS}	A0*	V _{SS}	NC	DQ _a
R	NC	A	MODE	V _{DD}	NC	A	NC
T	NC	A	A	NC	A	A	ZZ
U	V _{DDQ}	TMS	TDI	TCK	TDO	NC	V _{DDQ}

Note: A0 and A1 are the two least significant bits (LSB) of the address field and set the internal burst counter if burst is desired.

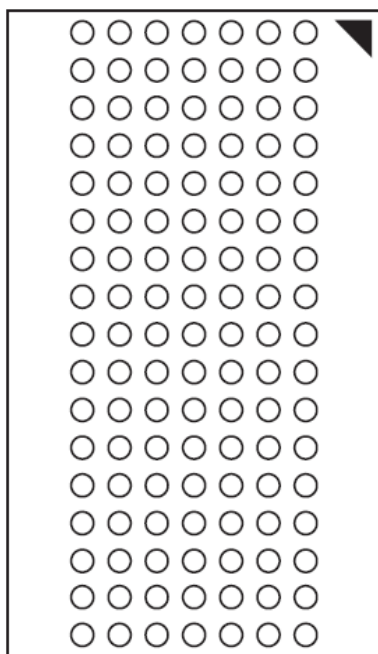

Bottom View
 119-Ball, 14 mm x 22 mm BGA

PIN DESCRIPTIONS

Symbol	Pin Name
CLK	Synchronous Clock
/CKE	Clock Enable
A0,A1	Synchronous Burst Address Inputs
A	Address Inputs
ADV	Synchronous Burst Address Advance/Load
MODE	Burst Sequence Selection
/CE,CE2,/CE2	Synchronous Chip Enable
/WE	Synchronous Read/Write Control Input
/BW _x (x=a-b)	Synchronous Byte Write Inputs
/OE	Output Enable
DQ _x	Data Inputs/Outputs
DQP _x	Parity Data I/O
TCK,TDI, TDO,TMS	JTAG Pins
ZZ	Power Sleep Mode
NC	No Connect
V _{DD}	Power Supply
V _{DDQ}	I/O Power Supply
V _{SS}	Ground

IS61NLP51236(32)B/IS61NVP51236(32)B/IS61NVVP51236(32)B
 IS61NLP102418B/IS61NVP102418B/IS61NVVP102418B



512K x 36, 100PIN QFP (Top View)

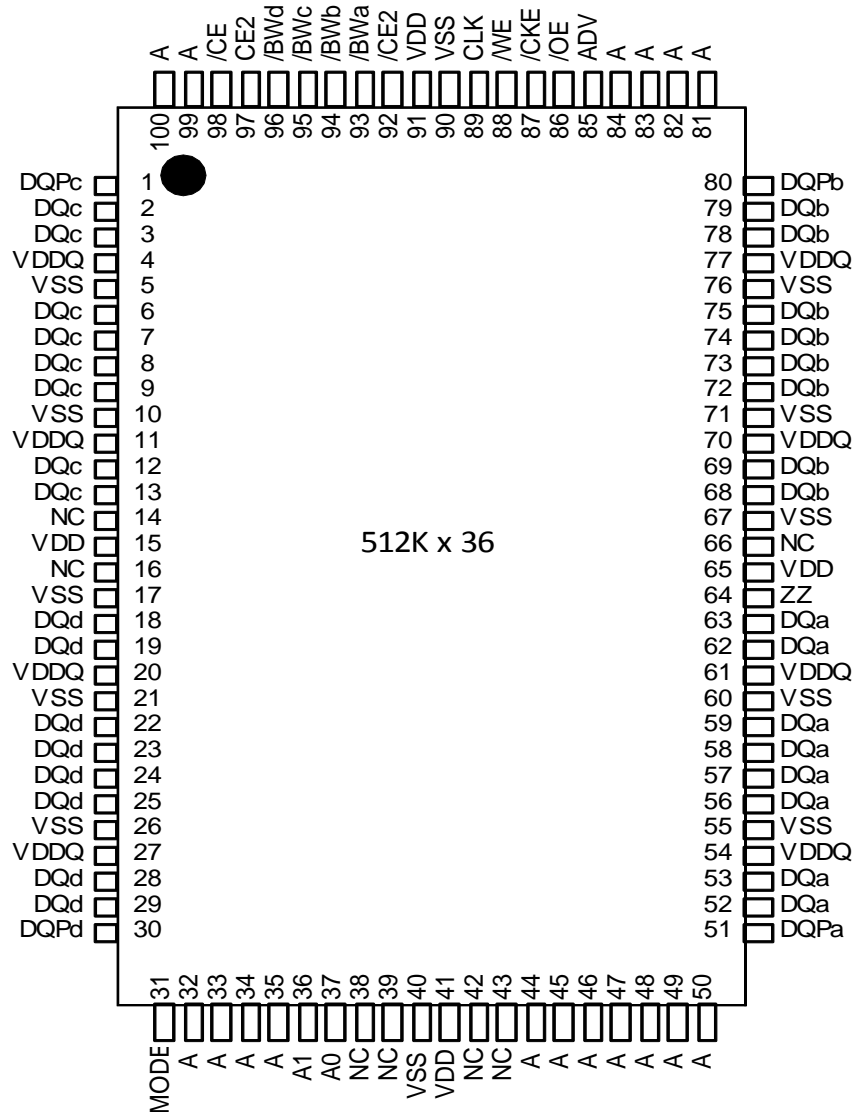

Note: A0 and A1 are the two least significant bits (LSB) of the address field and set the internal burst counter if burst is desired.

PIN DESCRIPTIONS

Symbol	Pin Name	Symbol	Pin Name
A	Address Inputs	ZZ	Power Sleep Mode
A0,A1	Synchronous Burst Address Inputs	MODE	Burst Sequence Selection
ADV	Synchronous Burst Address Advance/Load	V _{DD}	Power Supply
/WE	Synchronous Read/Write Control Input	NC	No Connect
CLK	Synchronous Clock	DQ _x	Data Inputs/Outputs
/CKE	Clock Enable	DQP _x	Parity Data I/O; NC for x32 option
/CE,CE2,/CE2	Synchronous Chip Enable	V _{DDQ}	I/O Power Supply
/BW _x (x=a-d)	Synchronous Byte Write Inputs	V _{SS}	Ground
/OE	Output Enable		

512K x 32, 100PIN QFP (Top View)

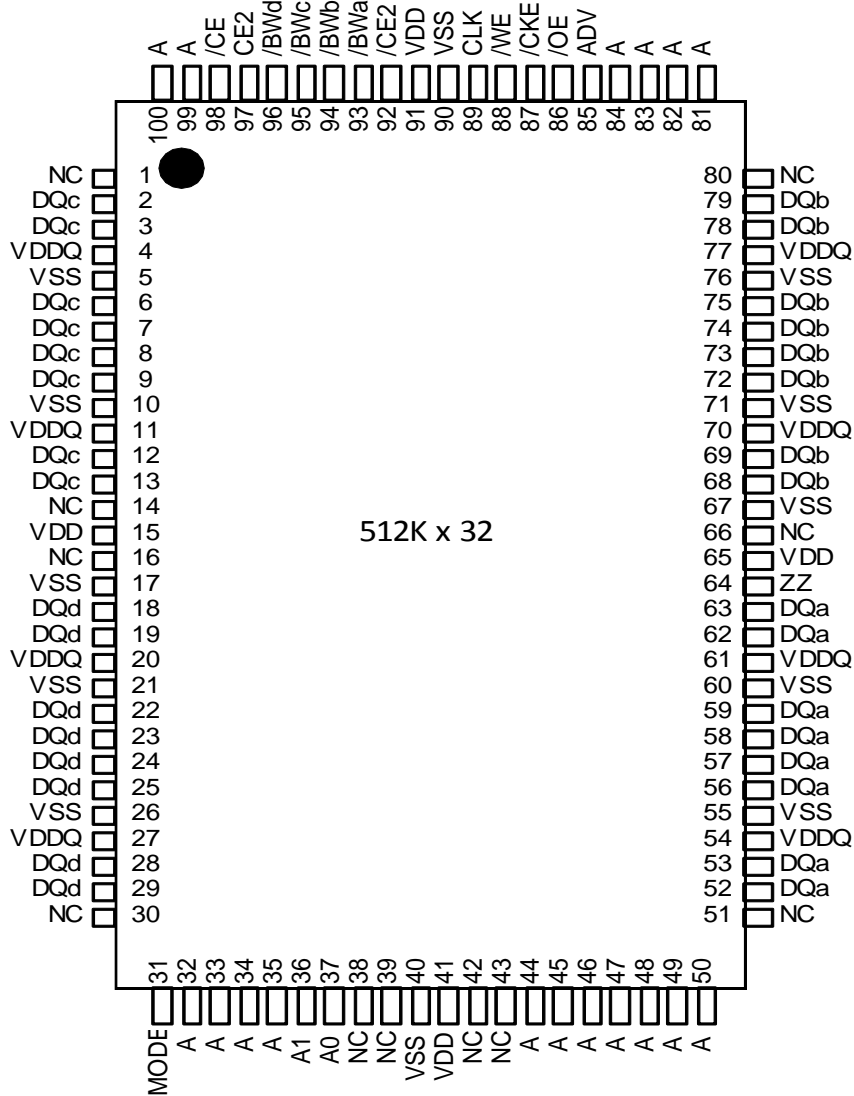

Note: A0 and A1 are the two least significant bits (LSB) of the address field and set the internal burst counter if burst is desired.

PIN DESCRIPTIONS

Symbol	Pin Name	Symbol	Pin Name
A	Address Inputs	ZZ	Power Sleep Mode
A0,A1	Synchronous Burst Address Inputs	MODE	Burst Sequence Selection
ADV	Synchronous Burst Address Advance/Load	V _{DD}	Power Supply
/WE	Synchronous Read/Write Control Input	NC	No Connect
CLK	Synchronous Clock	DQx	Data Inputs/Outputs
/CKE	Clock Enable	DQP _x	Parity Data I/O; NC for x32 option
/CE,CE2,/CE2	Synchronous Chip Enable	V _{DDQ}	I/O Power Supply
/BW _x (x=a-d)	Synchronous Byte Write Inputs	V _{SS}	Ground
/OE	Output Enable		

1024K x 18, 100PIN QFP (Top View)

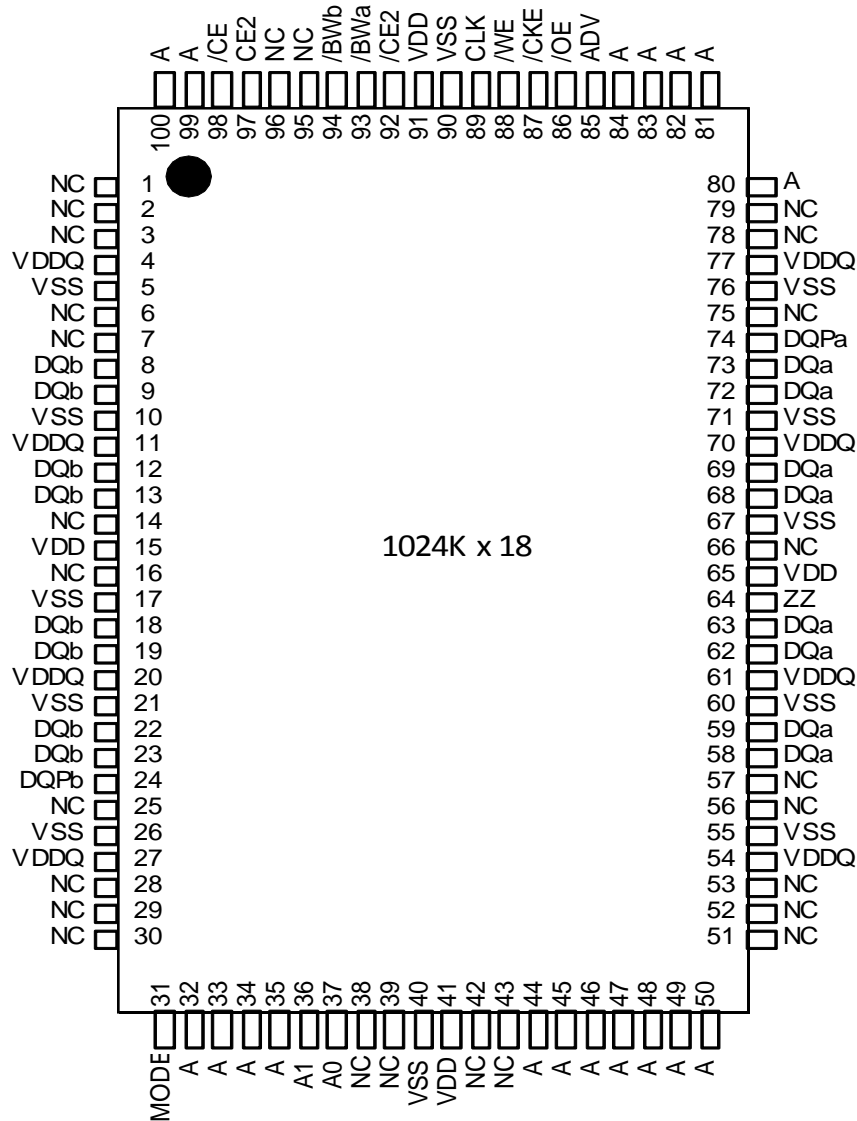

Note: A0 and A1 are the two least significant bits (LSB) of the address field and set the internal burst counter if burst is desired.

PIN DESCRIPTIONS

Symbol	Pin Name	Symbol	Pin Name
A	Address Inputs	ZZ	Power Sleep Mode
A0,A1	Synchronous Burst Address Inputs	MODE	Burst Sequence Selection
ADV	Synchronous Burst Address Advance/Load	V _{DD}	Power Supply
/WE	Synchronous Read/Write Control Input	NC	No Connect
CLK	Synchronous Clock	DQx	Data Inputs/Outputs
/CKE	Clock Enable	DQPx	Parity Data I/O
/CE,CE2,/CE2	Synchronous Chip Enable	V _{DDQ}	I/O Power Supply
/BWx (x=a-b)	Synchronous Byte Write Inputs	V _{SS}	Ground
/OE	Output Enable		

STATE DIAGRAM

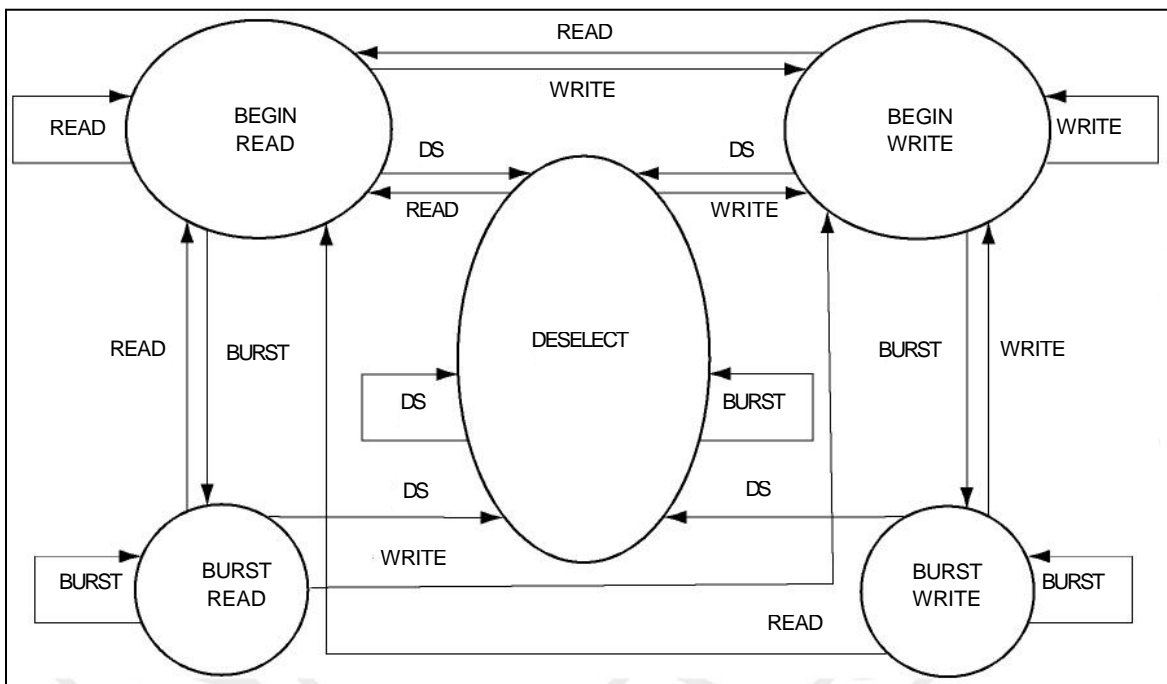

TRUTH TABLE

SYNCHRONOUS TRUTH TABLE

Operation	Address Used	/CE	CE2	/CE2	ADV	/WE	/BWx	/OE	/CKE	CLK
Not Selected	N/A	H	X	X	L	X	X	X	L	↑
Not Selected	N/A	X	L	X	L	X	X	X	L	↑
Not Selected	N/A	X	X	H	L	X	X	X	L	↑
Not Selected Continue	N/A	X	X	X	H	X	X	X	L	↑
Begin Burst Read	External Address	L	H	L	L	H	X	L	L	↑
Continue Burst Read	Next Address	X	X	X	H	X	X	L	L	↑
NOP/Dummy Read	External Address	L	H	L	L	H	X	H	L	↑
Dummy Read	Next Address	X	X	X	H	X	X	H	L	↑
Begin Burst Write	External Address	L	H	L	L	L	L	X	L	↑
Continue Burst Write	Next Address	X	X	X	H	X	L	X	L	↑
NOP/Write Abort	N/A	L	H	L	L	L	H	X	L	↑
Write Abort	Next Address	X	X	X	H	X	H	X	L	↑
Ignore Clock	Current Address	X	X	X	X	X	X	X	H	↑

Notes:

- "X" means don't care.
- The rising edge of clock is symbolized by ↑
- A continue deselect cycle can only be entered if a deselect cycle is executed first.
- /WE = L means Write operation in Write Truth Table.
- /WE = H means Read operation in Write Truth Table.
- Operation finally depends on status of asynchronous pins (ZZ and /OE).

ASYNCHRONOUS TRUTH TABLE

Operation	ZZ	/OE	I/O STATUS
Sleep Mode	H	X	High-Z
Read	L	L	DQ
	L	H	High-Z
Write	L	X	Din, High-Z
Deselected	L	X	High-Z

Notes:

1. X means "Don't Care".
2. For write cycles following read cycles, the output buffers must be disabled with /OE, otherwise data bus contention will occur.
3. Sleep Mode means power Sleep Mode where stand-by current does not depend on cycle time.
4. Deselected means power Sleep Mode where stand-by current depends on cycle time.

WRITE TRUTH TABLE (x18)

Operation	/WE	/BWa	/BWb
READ	H	X	X
WRITE BYTE a	L	L	H
WRITE BYTE b	L	H	L
WRITE ALL BYTES	L	L	L
WRITE ABORT/NOP	L	H	H

Notes:

1. X means "Don't Care".
2. All inputs in this table must be setup and hold time around the rising edge of CLK.

WRITE TRUTH TABLE (x36)

Operation	/WE	/BWa	/BWb	/BWc	/BWd
READ	H	X	X	X	X
WRITE BYTE a	L	L	H	H	H
WRITE BYTE b	L	H	L	H	H
WRITE BYTE c	L	H	H	L	H
WRITE BYTE d	L	H	H	H	L
WRITE ALL BYTES	L	L	L	L	L
WRITE ABORT/NOP	L	H	H	H	H

Notes:

1. X means "Don't Care".
2. All inputs in this table must be setup and hold time around the rising edge of CLK.

ADDRESS SEQUENCE IN BURST MODE

INTERLEAVED BURST ADDRESS TABLE (MODE = V_{DD} or NC)

External Address	1st Burst Address	2nd Burst Address	3rd Burst Address
A1 A0	A1 A0	A1 A0	A1 A0
00	01	10	11
01	00	11	10
10	11	00	01
11	10	01	00

LINEAR BURST ADDRESS TABLE (MODE = V_{SS})

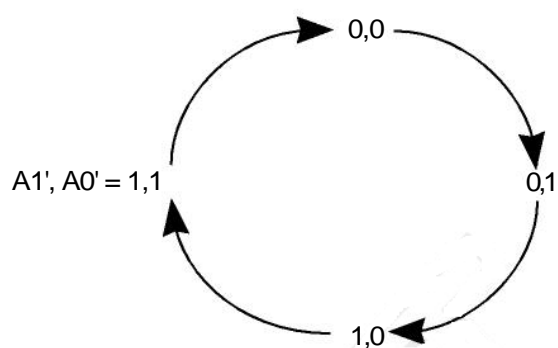

ABSOLUTE MAXIMUM RATINGS AND OPERATING RANGE

ABSOLUTE MAXIMUM RATINGS

Symbol	Parameter	NLP Value	NVP/NVVP Value	Unit
Tstg	Storage Temperature	-65 to +150	-65 to +150	°C
Pd	Power Dissipation	1.6	1.6	W
Iout	Output Current (per I/O)	20	20	mA
Vin, Vout	Voltage Relative to Vss for I/O Pins	-0.5 to V _{DDQ} +0.3	-0.5 to V _{DDQ} + 0.3	V
Vin	Voltage Relative to Vss for Address and Control Inputs	-0.3 to V _{DD} +0.5	-0.3 to V _{DD} + 0.3	V

Notes:

1. Stress greater than those listed under ABSOLUTE MAXIMUM RATINGS may cause permanent damage to the device. This is a stress rating only and functional operation of the device at these or any other conditions above those indicated in the operational sections of this specification is not implied. Exposure to absolute maximum rating conditions for extended periods may affect reliability.
2. This device contains circuitry to protect the inputs against damage due to high static voltages or electric fields; however, precautions may be taken to avoid application of any voltage higher than maximum rated voltages to this high-impedance circuit.
3. This device contains circuitry that will ensure the output devices are in High-Z at power up.

OPERATING RANGE (IS61NLPx)

Range	Ambient Temperature	V _{DD}	V _{DDQ}
Commercial	0°C to +70°C	3.3V ± 5%	3.3V / 2.5V ± 5%
Industrial	-40°C to +85°C	3.3V ± 5%	3.3V / 2.5V ± 5%
Automotive	-40°C to +125°C	3.3V ± 5%	3.3V / 2.5V ± 5%

OPERATING RANGE (IS61NVPx)

Range	Ambient Temperature	V _{DD}	V _{DDQ}
Commercial	0°C to +70°C	2.5V ± 5%	2.5V ± 5%
Industrial	-40°C to +85°C	2.5V ± 5%	2.5V ± 5%
Automotive	*Please contact ISSI		

OPERATING RANGE (IS61NVVPx)

Range	Ambient Temperature	V _{DD}	V _{DDQ}
Commercial	0°C to +70°C	1.8V ± 5%	1.8V ± 5%
Industrial	-40°C to +85°C	1.8V ± 5%	1.8V ± 5%
Automotive	*Please contact ISSI		

CHARACTERISTICS

DC ELECTRICAL CHARACTERISTICS (Over operating temperature range)

Symbol	Parameter	Test Conditions	3.3V		2.5V		1.8V		Unit
			Min.	Max.	Min.	Max.	Min.	Max.	
Voh	Output HIGH Voltage	Ioh=-4.0 mA(3.3V)	2.4	—	2.0	—	V _{DDQ} -0.4	—	V
		Ioh=-1.0 mA(2.5V,1.8V)							
Vol	Output LOW Voltage	Iol=8.0 mA(3.3V)	—	0.4	—	0.4	—	0.4	V
		Iol=1.0 mA(2.5V,1.8V)							
Vih	Input HIGH Voltage		2.0	V _{DD} +0.3	1.7	V _{DD} +0.3	0.7* V _{DD}	V _{DD} +0.3	V
Vil	Input LOW Voltage		-0.3	0.8	-0.3	0.7	-0.3	0.3* V _{DD}	V
Ili	Input Leakage Current	V _{SS} ≤Vin≤ V _{DD}	-1	1	-1	1	-1	1	μA
Ilo	Output Leakage Current	V _{SS} ≤Vout≤ V _{DDQ} ,/OE=Vih	-1	1	-1	1	-1	1	μA

Notes:

- All voltages referenced to ground.
- Overshoot:
3.3V and 2.5V: Vih (AC) ≤ V_{DD} + 1.5V (Pulse width less than t_{kc} /2)
1.8V: Vih (AC) ≤ V_{DD} + 0.5V (Pulse width less than t_{kc} /2)
- Undershoot:
3.3V and 2.5V: Vil (AC) ≥ -1.5V (Pulse width less than t_{kc} /2)
1.8V: Vil (AC) ≥ -0.5V (Pulse width less than t_{kc} /2)
- MODE pin has an internal pull-up and should be tied to V_{DD} or V_{SS}. It exhibits ±100μA maximum leakage current when tied to ≤V_{SS}+0.2V or ≥ V_{DD}-0.2V.
- ZZ pin has an internal pull-down and should be tied to V_{DD} or V_{SS}. It exhibits ±100μA maximum leakage current when tied to ≤V_{SS}+0.2V or ≥ V_{DD}-0.2V.

POWER SUPPLY CHARACTERISTICS (Over Operating Range)

Symbol	Parameter	Test Conditions	Temp. range	-250		-200		Unit
				Max		Max		
				x18	x36	x18	x36	
Icc	AC Operating, Supply Current	Device Selected, OE = Vih, ZZ ≤ Vil, All Inputs ≤ 0.2V or ≥ V _{DD} - 0.2V, Cycle Time ≥ t _{kc} min.	Com.	270	270	220	220	mA
			Ind.	290	290	240	240	
Isb	Standby Current TTL Input	Device Deselected, V _{DD} = Max., All Inputs ≤ Vil or ≥ Vih, ZZ ≤ Vil, f = Max.	Com.	80	80	70	70	mA
			Ind.	90	90	80	80	
Isb1	Standby Current CMOS Input	Device Deselected, V _{DD} = Max., Vin ≤ V _{SS} + 0.2V or ≥ V _{DD} - 0.2V, f = 0	Com.	60	60	60	60	mA
			Ind.	70	70	70	70	

Note:

- Power-up assumes a linear ramp from 0V to V_{DD} (min) within 200ms. During this time Vih < V_{DD} and V_{DDQ} < V_{DD}

CAPACITANCE

Symbol	Parameter	Conditions	Max.	Unit
Cin	Input Capacitance	Vin = 0V	6	pF
Cout	Input/Output Capacitance	Vout = 0V	8	pF

Notes:

1. Tested initially and after any design or process changes that may affect these parameters.
2. Test conditions: Ta = 25°C, f = 1 MHz, VDD = 3.3V.

READ/WRITE CYCLE SWITCHING CHARACTERISTICS (Over Operating Range)

Symbol	Parameter	-250		-200		Unit
		Min.	Max.	Min.	Max.	
fmax	Clock Frequency	—	250	—	200	MHz
tkc	Cycle Time	4	—	5	—	ns
tkh	Clock High Time	1.7	—	2	—	ns
tkl	Clock Low Time	1.7	—	2	—	ns
tkq	Clock Access Time	—	2.6	—	3.0	ns
tkqx ⁽²⁾	Clock High to Output Invalid	0.8	—	1.5	—	ns
tkqlz ^(2,3)	Clock High to Output Low-Z	0.8	—	1	—	ns
tkqhz ^(2,3)	Clock High to Output High-Z	—	2.6	—	3.0	ns
toeq	Output Enable to Output Valid	—	2.6	—	3.0	ns
toelz ^(2,3)	Output Enable to Output Low-Z	0	—	0	—	ns
toehz ^(2,3)	Output Disable to Output High-Z	—	2.6	—	3.0	ns
tas	Address Setup Time	1.2	—	1.4	—	ns
tws	Read/Write Setup Time	1.2	—	1.4	—	ns
tces	Chip Enable Setup Time	1.2	—	1.4	—	ns
tse	Clock Enable Setup Time	1.2	—	1.4	—	ns
tadv	Address Advance Setup Time	1.2	—	1.4	—	ns
tds	Data Setup Time	1.2	—	1.4	—	ns
tah	Address Hold Time	0.3	—	0.4	—	ns
the	Clock Enable Hold Time	0.3	—	0.4	—	ns
twh	Write Hold Time	0.3	—	0.4	—	ns
tceh	Chip Enable Hold Time	0.3	—	0.4	—	ns
tadvh	Address Advance Hold Time	0.3	—	0.4	—	ns
tdh	Data Hold Time	0.3	—	0.4	—	ns

Notes:

1. Configuration signal MODE is static and must not change during normal operation.
2. Guaranteed but not 100% tested. This parameter is periodically sampled.
3. Tested with load in Figure 2.

3.3V I/O AC TEST CONDITIONS

Parameter	Unit
Input Pulse Level	0V to 3.0V
Input Rise and Fall Times	1.5 ns
Input and Output Timing and Reference Level	1.5V
V_{TT}	1.5V
V_{LOAD}	3.3V
R1, R2	317 Ω , 351 Ω
Output Load	See Figures 1 and 2

2.5V I/O AC TEST CONDITIONS

Parameter	Unit
Input Pulse Level	0V to 2.5V
Input Rise and Fall Times	1.5 ns
Input and Output Timing and Reference Level	1.25V
V_{TT}	1.25V
V_{LOAD}	2.5V
R1, R2	1667 Ω , 1538 Ω
Output Load	See Figures 1 and 2

1.8V I/O AC TEST CONDITIONS

Parameter	Unit
Input Pulse Level	0V to 1.8V
Input Rise and Fall Times	1.5 ns
Input and Output Timing and Reference Level	0.9V
V_{TT}	0.9V
V_{LOAD}	1.8V
R1, R2	1K Ω , 1K Ω
Output Load	See Figures 1 and 2

I/O OUTPUT LOAD EQUIVALENT

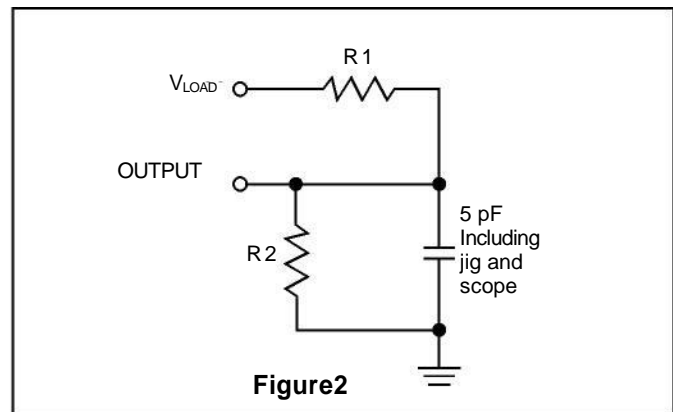
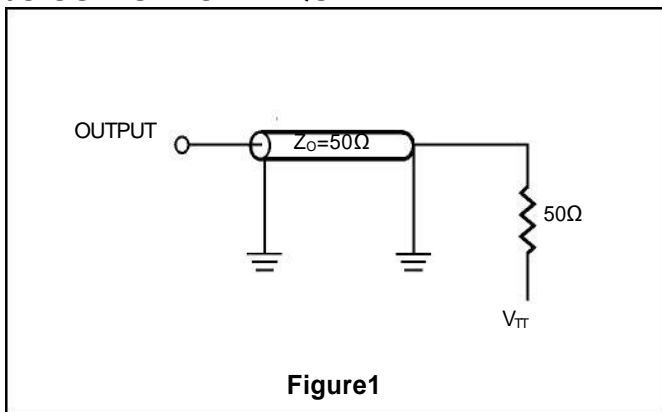

READ CYCLE TIMING

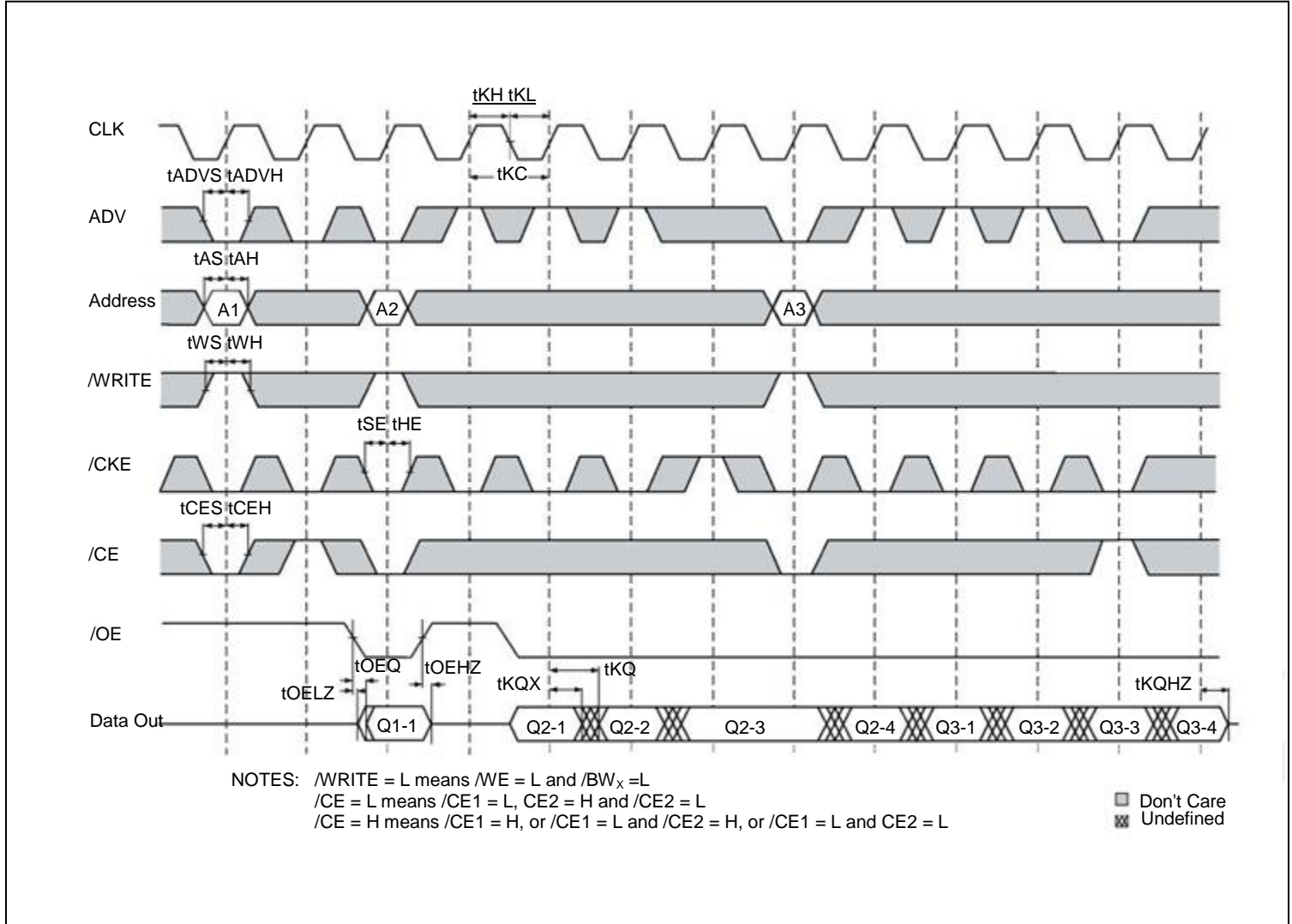

WRITE CYCLE TIMING

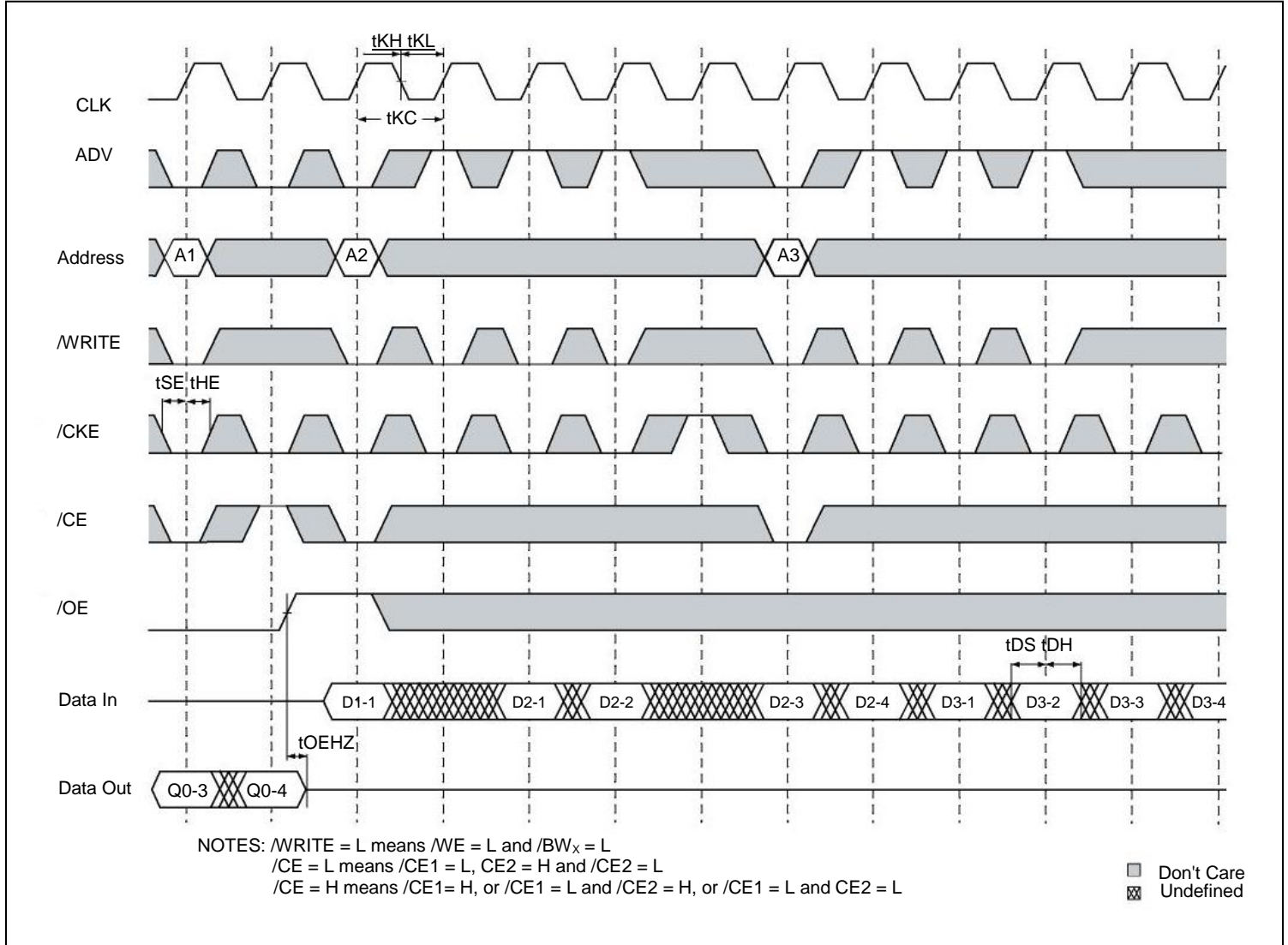

SINGLE READ/WRITE CYCLE TIMING

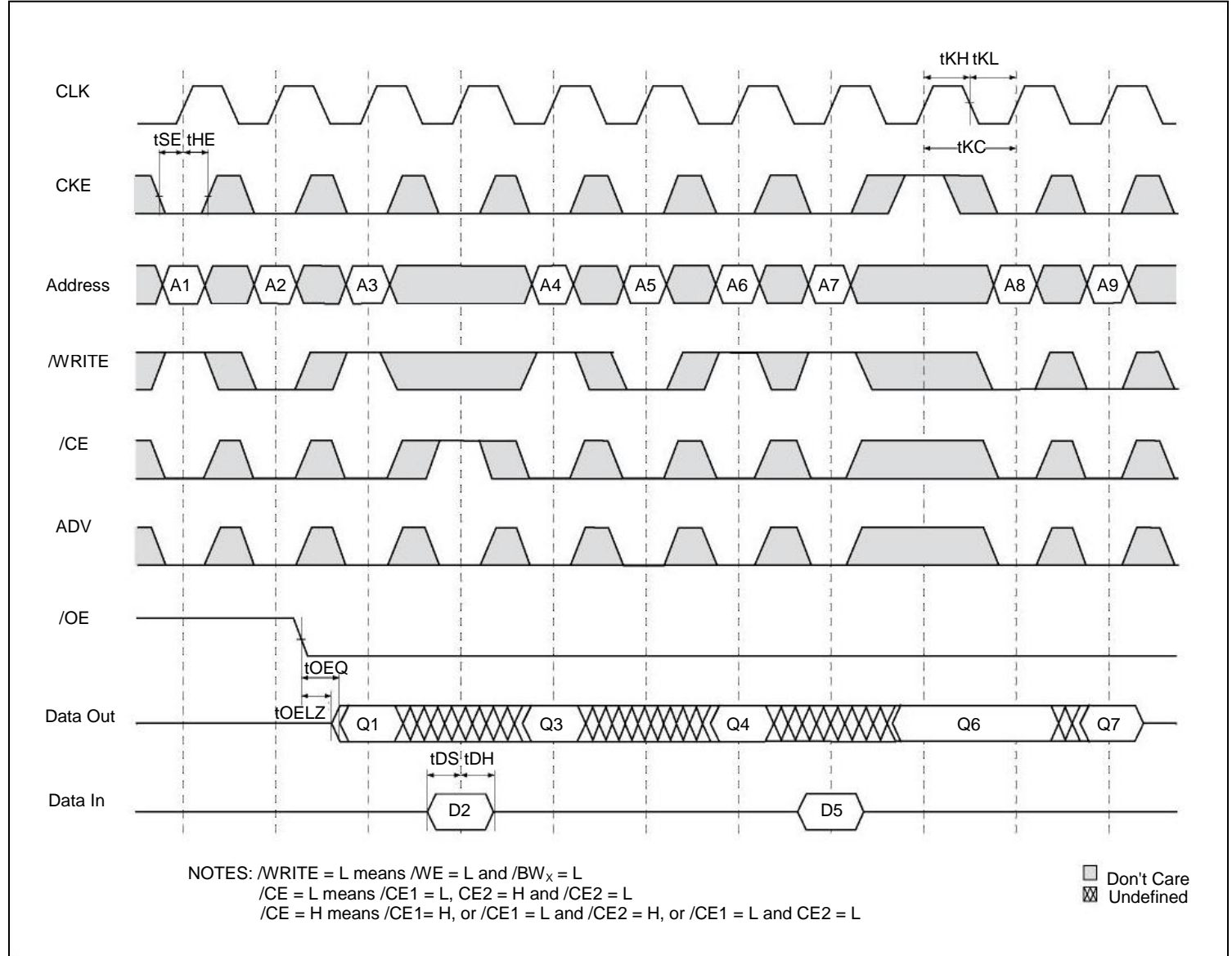

/CKE OPERATION TIMING

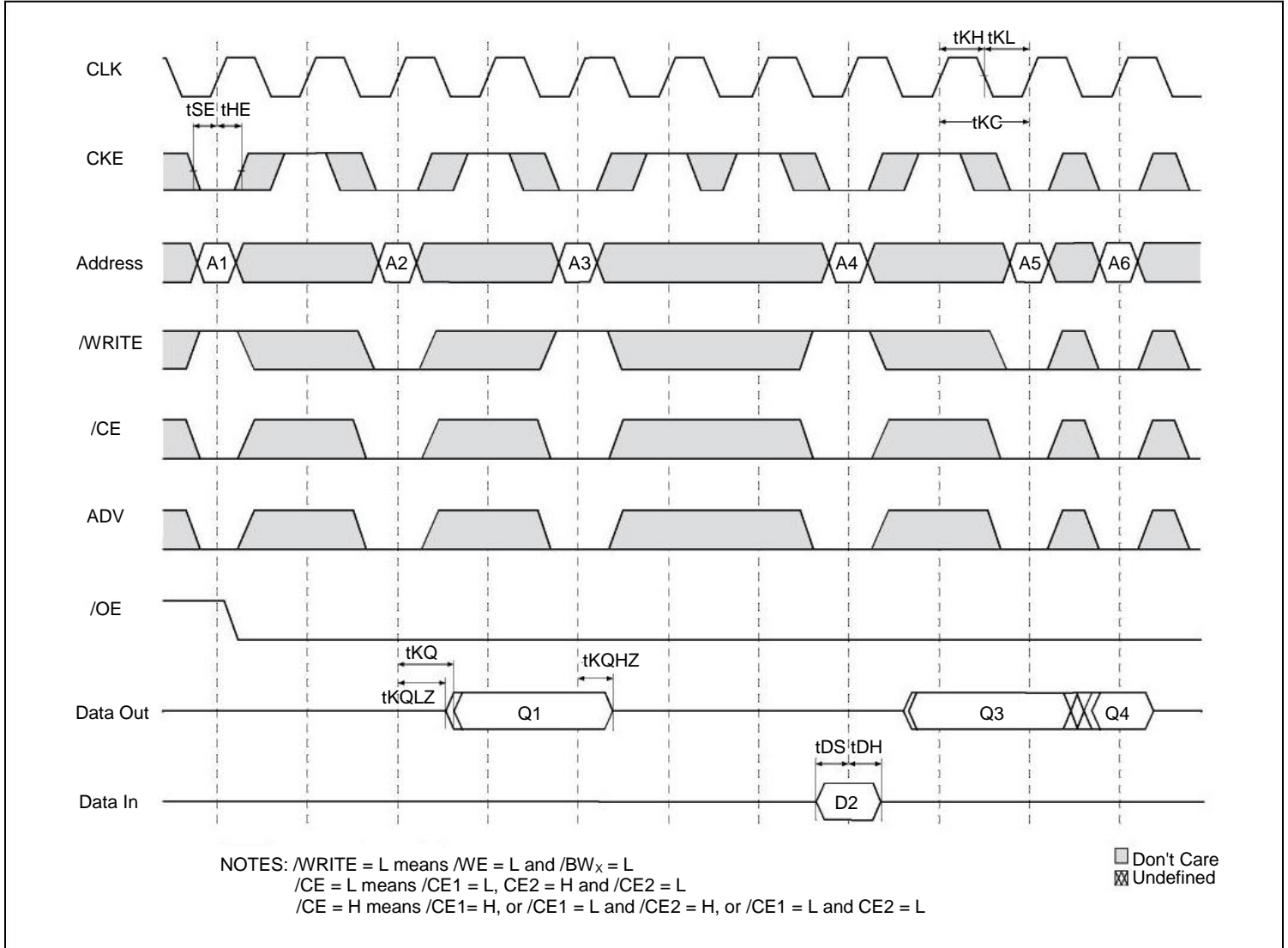

/ICE OPERATION TIMING

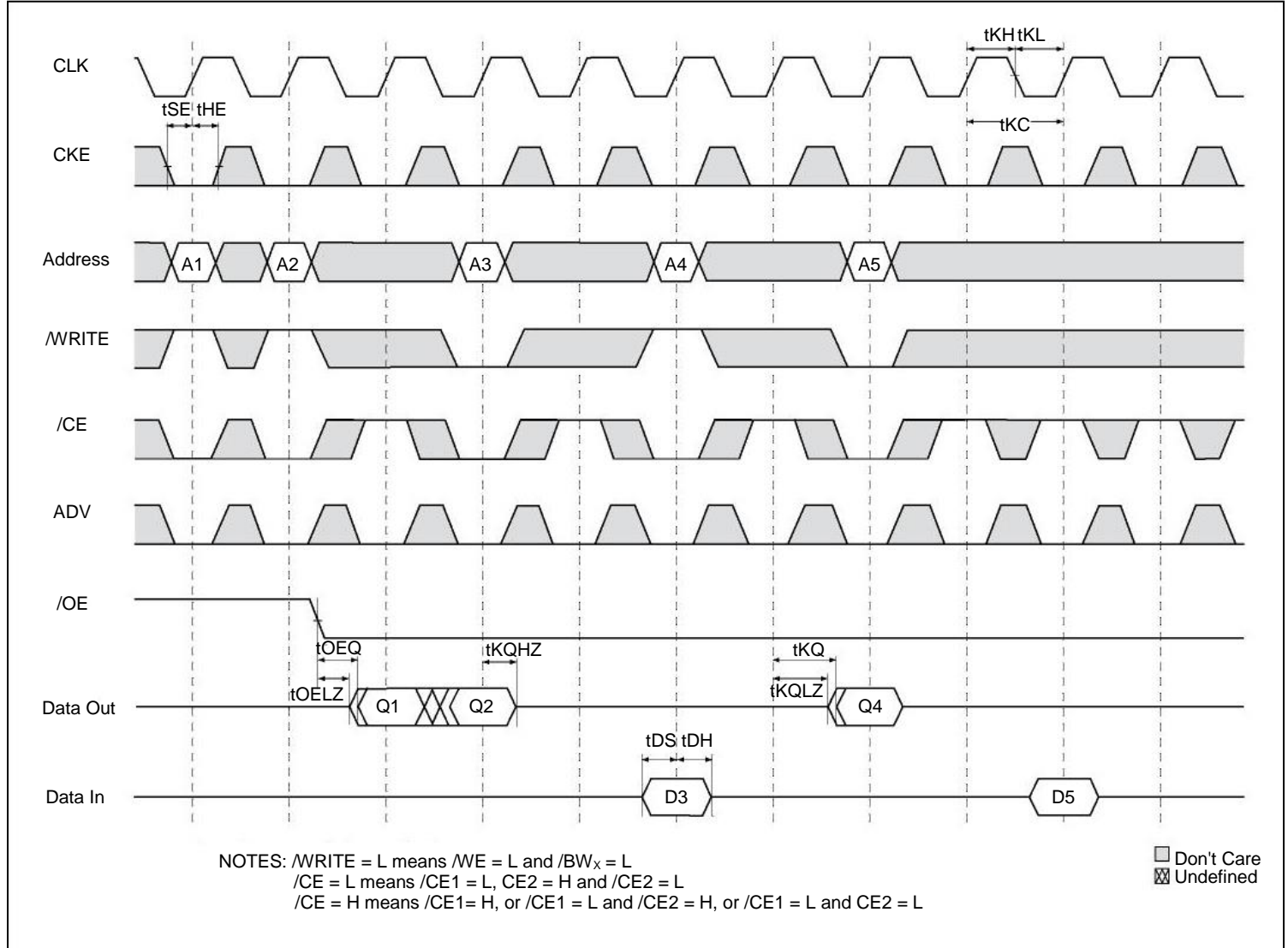

SNOOZE MODE ELECTRICAL CHARACTERISTICS

Symbol	Parameter	Conditions	Temperature Range	Min.	Max.	Unit
ISB2	Current during SNOOZE MODE	ZZ ≥ V _{ih}	Com.	—	40	mA
			Ind.	—	50	
			Auto.	—	TBD	
tPDS	ZZ active to input ignored		—	—	2	cycle
tPUS	ZZ inactive to input sampled		—	2	—	cycle
tZZI	ZZ active to SNOOZE current		—	—	2	cycle
tRZZI	ZZ inactive to exit SNOOZE current		—	0	—	ns

SLEEP MODE TIMING

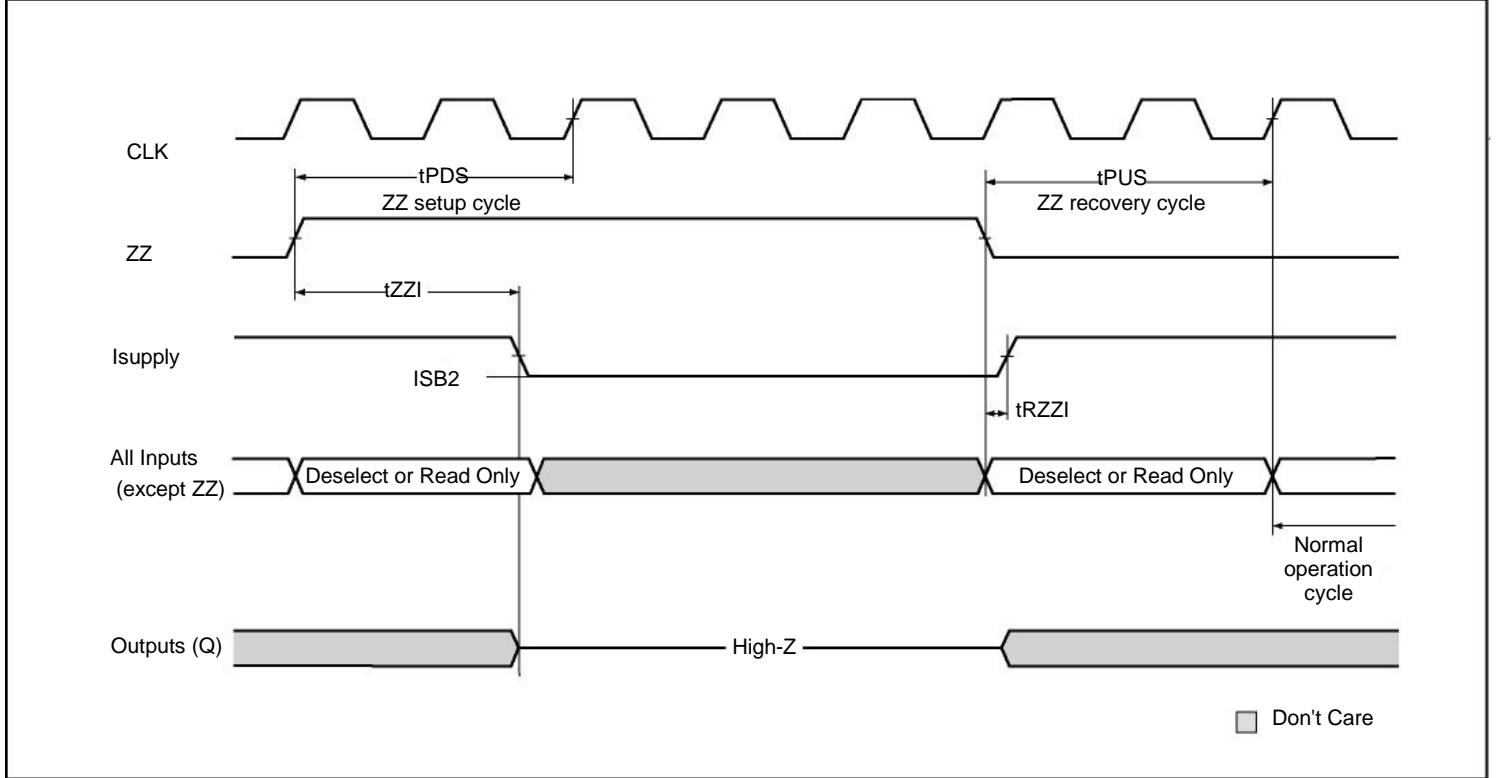

IEEE 1149.1 TAP and Boundary Scan

The SRAM provides a limited set of JTAG functions to test the interconnection between SRAM I/Os and printed circuit board traces or other components. There is no multiplexer in the path from I/O pins to the RAM core.

In conformance with IEEE Standard 1149.1, the SRAM contains a TAP controller, instruction register, boundary scan register, bypass register, and ID register.

The TAP controller has a standard 16-state machine that resets internally on power-up. Therefore, a TRST signal is not required

Disabling the JTAG feature

The SRAM can operate without using the JTAG feature. To disable the TAP controller, TCK must be tied LOW (VSS) to prevent clocking of the device. TDI and TMS are internally pulled up and may be left disconnected. They may alternately be connected to V_{DD} through a pull-up resistor. TDO should be left disconnected. On power-up, the device will come up in a reset state, which will not interfere with device operation.

Test Access Port Signal List:

1. Test Clock (TCK)

This signal uses V_{DD} as a power supply. The test clock is used only with the TAP controller. All inputs are captured on the rising edge of TCK. All outputs are driven from the falling edge of TCK.

2. Test Mode Select (TMS)

This signal uses V_{DD} as a power supply. The TMS input is used to send commands to the TAP controller and is sampled on the rising edge of TCK.

3. Test Data-In (TDI)

This signal uses V_{DD} as a power supply. The TDI input is used to serially input test instructions and information into the registers and can be connected to the input of any of the registers. The register between TDI and TDO is chosen by the instruction that is loaded into the TAP instruction register. TDI is connected to the most significant bit (MSB) of any register. For more information regarding instruction register loading, please see the TAP Controller State Diagram.

4. Test Data-Out (TDO)

This signal uses V_{DD} as a power supply. The TDO output ball is used to serially clock test instructions and data out from the registers. The TDO output driver is only active during the Shift-IR and Shift-DR TAP controller states. In all other states, the TDO pin is in a High-Z state. The output changes on the falling edge of TCK. TDO is connected to the least significant bit (LSB) of any register. For more information, please see the TAP Controller State Diagram.

TAP Controller State and Block Diagram

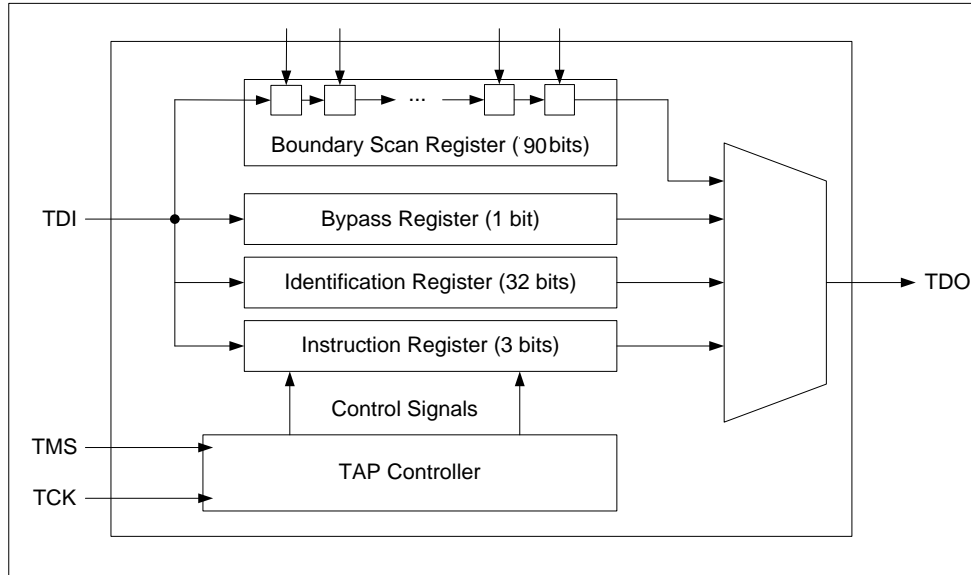

TAP Controller State Machine

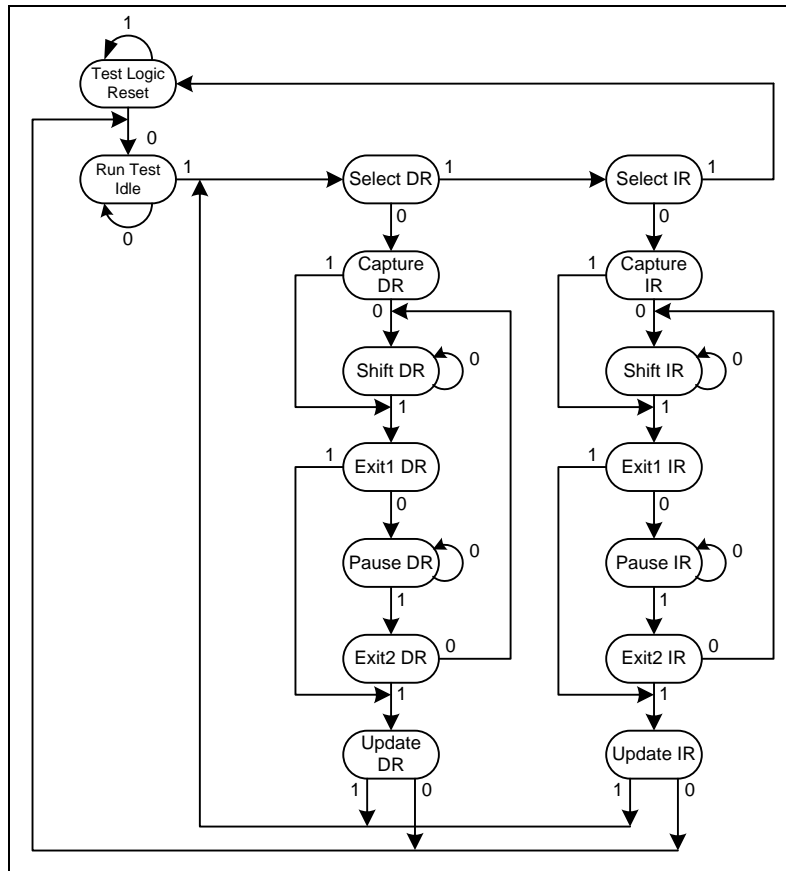

Performing a TAP Reset

A Reset is performed by forcing TMS HIGH (V_{DD}) for five rising edges of TCK. RESET may be performed while the SRAM is operating and does not affect its operation. At power-up, the TAP is internally reset to ensure that TDO comes up in a high-Z state.

TAP Registers

Registers are connected between the TDI and TDO pins and allow data to be scanned into and out of the SRAM test circuitry. Only one register can be selected at a time through the instruction registers. Data is serially loaded into the TDI pin on the rising edge of TCK and output on the TDO pin on the falling edge of TCK.

1. Instruction Register

This register is loaded during the update-IR state of the TAP controller. At power-up, the instruction register is loaded with the IDCODE instruction. It is also loaded with the IDCODE instruction if the controller is placed in a reset state as described in the previous section. When the TAP controller is in the capture-IR state, the two LSBs are loaded with a binary “01” pattern to allow for fault isolation of the board-level serial test data path.

2. Bypass Register

The bypass register is a single-bit register that can be placed between the TDI and TDO balls. This allows data to be shifted through the SRAM with minimal delay. The bypass register is set LOW (V_{SS}) when the BYPASS instruction is executed.

3. Boundary Scan Register

The boundary scan register is connected to all the input and bidirectional balls on the SRAM. Several balls are also included in the scan register to reserved balls. The boundary scan register is loaded with the contents of the SRAM Input and Output ring when the TAP controller is in the capture-DR state and is then placed between the TDI and TDO balls when the controller is moved to the shift-DR state. Each bit corresponds to one of the balls on the SRAM package. The MSB of the register is connected to TDI, and the LSB is connected to TDO.

4. Identification (ID) Register

The ID register is loaded with a vendor-specific, 32-bit code during the capture-DR state when the IDCODE command is loaded in the instruction register. The IDCODE is hardwired into the SRAM and can be shifted out when the TAP controller is in the shift-DR state.

Scan Register Sizes

Register Name	Bit Size
Instruction	3
Bypass	1
ID	32
Boundary Scan	90

TAP Instruction Set

Many instructions are possible with an eight-bit instruction register and all valid combinations are listed in the TAP Instruction Code Table. All other instruction codes that are not listed on this table are reserved and should not be used. Instructions are loaded into the TAP controller during the Shift-IR state when the instruction register is placed between TDI and TDO. During this state, instructions are shifted from the instruction register through the

TDI and TDO pins. To execute an instruction once it is shifted in, the TAP controller must be moved into the Update-IR state.

1. EXTEST

The EXTEST instruction allows circuitry external to the component package to be tested. Boundary-scan register cells at output balls are used to apply a test vector, while those at input balls capture test results. Typically, the first test vector to be applied using the EXTEST instruction will be shifted into the boundary scan register using the PRELOAD instruction. Thus, during the update-IR state of EXTEST, the output driver is turned on, and the PRELOAD data is driven onto the output balls.

2. IDCODE

The IDCODE instruction causes a vendor-specific, 32-bit code to be loaded into the instruction register. It also places the instruction register between the TDI and TDO balls and allows the IDCODE to be shifted out of the device when the TAP controller enters the shift-DR state. The IDCODE instruction is loaded into the instruction register upon power-up or whenever the TAP controller is given a test logic reset state.

3. SAMPLE Z

If the SAMPLE-Z instruction is loaded in the instruction register, all SRAM outputs are forced to an inactive drive state (high-Z), moving the TAP controller into the capture-DR state loads the data in the SRAMs input into the boundary scan register, and the boundary scan register is connected between TDI and TDO when the TAP controller is moved to the shift-DR state.

4. SAMPLE/PRELOAD

When the SAMPLE/PRELOAD instruction is loaded into the instruction register and the TAP controller is in the capture-DR state, a snapshot of data on the inputs and bidirectional balls is captured in the boundary scan register. The user must be aware that the TAP controller clock can only operate at a frequency up to 10 MHz, while the SRAM clock operates significantly faster. Because there is a large difference between the clock frequencies, it is possible that during the capture-DR state, an input or output will undergo a transition. The TAP may then try to capture a signal while in transition. This will not harm the device, but there is no guarantee as to the value that will be captured. Repeatable results may not be possible. To ensure that the boundary scan register will capture the correct value of a signal, the SRAM signal must be stabilized long enough to meet the TAP controller's capture setup plus hold time. The SRAM clock input might not be captured correctly if there is no way in a design to stop (or slow) the clock during a SAMPLE/ PRELOAD instruction. If this is an issue, it is still possible to capture all other signals and simply ignore the value of the CLK captured in the boundary scan register. Once the data is captured, it is possible to shift out the data by putting the TAP into the shift-DR state. This places the boundary scan register between the TDI and TDO balls.

6. BYPASS

When the BYPASS instruction is loaded in the instruction register and the TAP is placed in a shift-DR state, the bypass register is placed between TDI and TDO. The advantage of the BYPASS instruction is that it shortens the boundary scan path when multiple devices are connected together on a board.

7. PRIVATE

Do not use these instructions. They are reserved for future use and engineering mode.

JTAG DC Operating Characteristics

(Over the Operating Temperature Range, 2.5V and 3.3V Option)

Parameter	Symbol	Min	Max	Units	Notes
JTAG Input High Voltage	V_{IH1}	1.7	$V_{DD}+0.3$	V	
JTAG Input Low Voltage	V_{IL1}	-0.3	0.7	V	
JTAG Output High Voltage	V_{OH1}	1.7	-	V	$ I_{OH1} =2mA$
JTAG Output Low Voltage	V_{OL1}	-	0.7	V	$I_{OL1}=2mA$
JTAG Output High Voltage	V_{OH2}	2.1	-	V	$ I_{OH2} =100\mu A$
JTAG Output Low Voltage	V_{OL2}	-	0.2	V	$I_{OL2}=100\mu A$
JTAG Input Leakage Current	I_{LJTAG}	-10	+10	μA	$0 \leq V_{in} \leq V_{DD}$
JTAG Output Leakage Current	I_{LOJTAG}	-10	+10	μA	$0 \leq V_{out} \leq V_{DD}$

Notes:

- All voltages referenced to VSS (GND); All JTAG inputs and outputs are LVTTTL-compatible.

JTAG DC Operating Characteristics

(Over the Operating Temperature Range, 1.8V Option)

Parameter	Symbol	Min	Max	Units	Notes
JTAG Input High Voltage	V_{IH1}	TBD	TBD	V	
JTAG Input Low Voltage	V_{IL1}	TBD	TBD	V	
JTAG Output High Voltage	V_{OH1}	TBD	TBD	V	
JTAG Output Low Voltage	V_{OL1}	TBD	TBD	V	
JTAG Input Leakage Current	I_{LJTAG}	TBD	TBD	μA	
JTAG Output Leakage Current	I_{LOJTAG}	TBD	TBD	μA	

Notes:

- All voltages referenced to VSS (GND); All JTAG inputs and outputs are LVTTTL-compatible.

JTAG AC Test Conditions

(Over the Operating Temperature Range)

Parameter	Symbol	1.8V Option	2.5V Option	3.3V Option	Units
Input Pulse High Level	V_{IH1}	TBD	2.5	3.0	V
Input Pulse Low Level	V_{IL1}	TBD	0	0	V
Input rise and fall time	T_{R1}	TBD	1.5	1.5	ns
Test load termination supply voltage	V_{REF}	TBD	1.25	1.5	V
Input and Output Timing Reference Level	V_{REF}	TBD	1.25	1.5	V

TAP Output Load Equivalent

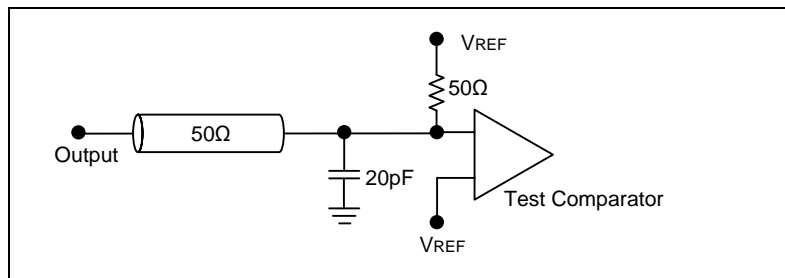

JTAG AC Characteristics

(Over the Operating Temperature Range)

Parameter	Symbol	Min	Max	Units
TCK cycle time	t_{THTH}	100	–	ns
TCK high pulse width	t_{THTL}	40	–	ns
TCK low pulse width	t_{TLTH}	40	–	ns
TMS Setup	t_{MVTH}	10	–	ns
TMS Hold	t_{THMX}	10	–	ns
TDI Setup	t_{DVTH}	10	–	ns
TDI Hold	t_{THDX}	10	–	ns
TCK Low to Valid Data	t_{TLOV}	–	20	ns

JTAG Timing Diagram

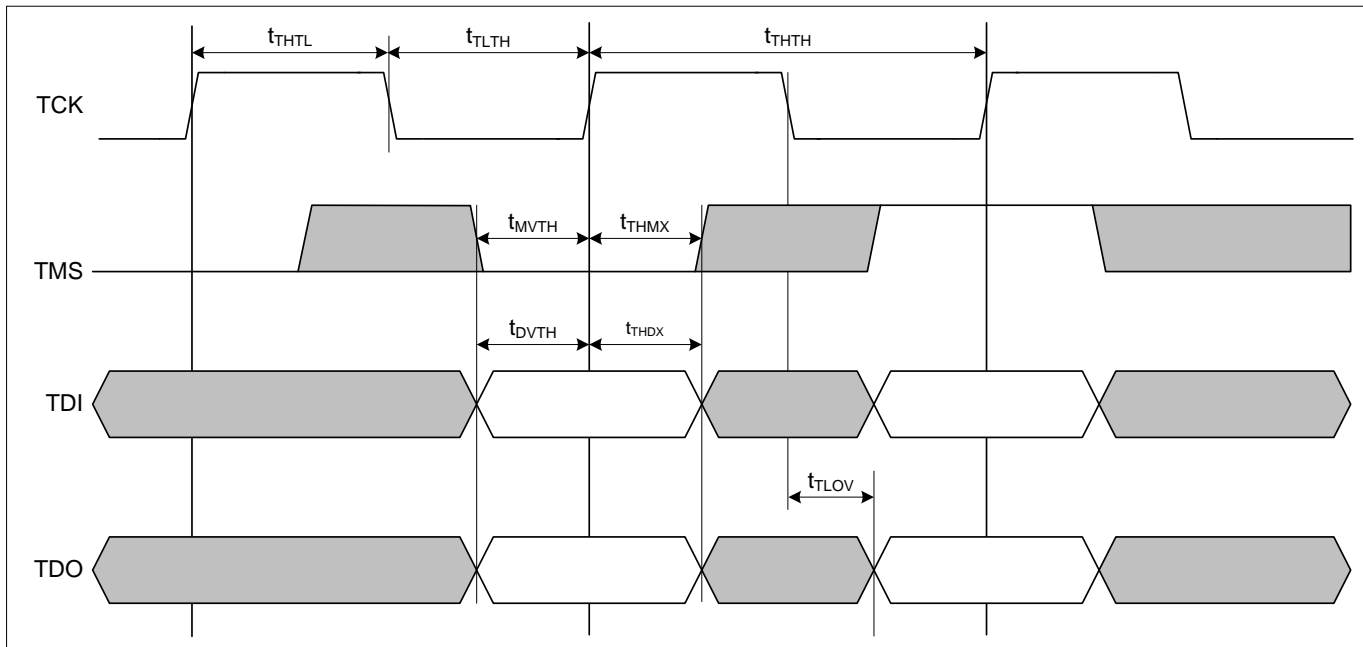

Instruction Set

Code	Instruction	TDO Output	Notes
000	EXTEST	Boundary Scan Register	2, 6
001	IDCODE	32-bit Identification Register	
010	SAMPLE-Z	Boundary Scan Register	1, 2
011	PRIVATE	Do Not Use	5
100	SAMPLE(/PRELOAD)	Boundary Scan Register	4
101	PRIVATE	Do Not Use	5
110	PRIVATE	Do Not Use	5
111	BYPASS	Bypass Register	3

Notes:

1. Places DQs in high-Z in order to sample all input data, regardless of other SRAM inputs.
2. TDI is sampled as an input to the first ID register to allow for the serial shift of the external TDI data.
3. BYPASS register is initiated to V_{SS} when BYPASS instruction is invoked. The BYPASS register also holds the last serially loaded TDI when exiting the shift-DR state.
4. SAMPLE instruction does not place DQs in high-Z.
5. This instruction is reserved. Invoking this instruction will cause improper SRAM functionality.
6. By default, it places DQs in high-Z. If the internal register on the scan chain is set high, DQs will be updated with information loaded via a previous SAMPLE instruction. The actual transfer occurs during the update IR state after EXTEST is loaded. The value of the internal register can be changed during SAMPLE and EXTEST only.

ID Register Definition

Instruction Field	Description	512K x 36	1024K x 18
Revision Number (31:28)	Reserved for version number.	xxxx	xxxx
Device Depth (27:23)	Defines depth of SRAM. 512K or 1024K	00111	01000
Device Width (22:18)	Defines Width of the SRAM. x36 or x18	00100	00011
ISSI Device ID (17:12)	Reserved for future use.	xxxxxxx	xxxxxxx
ISSI JEDEC ID (11:1)	Allows unique identification of SRAM vendor.	00001010101	00001010101
ID Register Presence (0)	Indicate the presence of an ID register.	1	1

Boundary Scan Order

(TBA – 119 BGA)

165 BGA				
Bit #	X36		X18	
	Bump ID	Signal	Bump ID	Signal
1	N6	NC	N6	NC
2	N7	NC	N7	NC
3	N10	NC	N10	NC
4	P11	NC	P11	NC
5	P8	A18	P8	A18
6	R8	A17	R8	A17
7	R9	A16	R9	A16
8	P9	A15	P9	A15
9	P10	A14	P10	A14
10	R10	A13	R10	A13
11	R11	A12	R11	A12
12	H11	ZZ	H11	ZZ
13	N11	DQa0	N11	NC
14	M11	DQa1	M11	NC
15	L11	DQa2	L11	NC
16	M10	DQa3	M10	DQa8
17	L10	DQa4	L10	DQa7
18	K11	DQa5	K11	NC
19	J11	DQa6	J11	NC
20	K10	DQa7	K10	DQa6
21	J10	DQa8	J10	DQa5
22	H9	NC	H9	NC
23	H10	NC	H10	NC
24	G11	DQb8	G11	DQa4
25	F11	DQb7	F11	DQa3
26	G10	DQb6	G10	NC
27	E11	DQb5	E11	DQa2
28	D11	DQb4	D11	DQa1
29	F10	DQb3	C11	DQa0
30	E10	DQb2	E10	NC
31	D10	DQb1	D10	NC
32	C11	DQb0	F10	NC
33	A11	NC	A11	A19
34	B11	NC	B11	NC
35	A10	A11	A10	A11
36	B10	A10	B10	A10
37	A9	A9	A9	A9

Continued on next page

165 BGA				
	X36		X18	
Bit #	Bump ID	Signal	Bump ID	Signal
38	B9	A8	B9	A8
39	C10	NC	C10	NC
40	A8	ADV	A8	ADV
41	B8	/OE	B8	/OE
42	A7	/CKE	A7	/CKE
43	B7	/WE	B7	/WE
44	B6	CLK	B6	CLK
45	A6	/CE2	A6	/CE2
46	B5	/Bwa	B5	/Bwa
47	A5	/Bwb	A5	NC
48	A4	/Bwc	A4	/Bwb
49	B4	/Bwd	B4	NC
50	B3	CE2	B3	CE2
51	A3	/CE1	A3	/CE1
52	A2	A7	A2	A7
53	B2	A6	B2	A6
54	C2	NC	C2	NC
55	B1	NC	B1	NC
56	A1	NC	A1	NC
57	C1	DQc0	C1	NC
58	D1	DQc1	D1	NC
59	E1	DQc2	E1	NC
60	D2	DQc3	D2	DQb8
61	E2	DQc4	E2	DQb7
62	F1	DQc5	F1	NC
63	G1	DQc6	G1	NC
64	F2	DQc7	F2	DQb6
65	G2	DQc8	G2	DQb5
66	H1	NC	H1	NC
67	H2	NC	H2	NC
68	H3	NC	H3	NC
69	J1	DQd8	J1	DQb4
70	K1	DQd7	K1	DQb3
71	J2	DQd6	J2	NC
72	L1	DQd5	L1	DQb2
73	M1	DQd4	M1	DQb1
74	K2	DQd3	N1	DQb0
75	L2	DQd2	L2	NC
76	M2	DQd1	M2	NC
77	N1	DQd0	K2	NC
78	N2	NC	N2	NC
79	P1	NC	P1	NC

Continued on next page

165 BGA				
Bit #	X36		X18	
	Bump ID	Signal	Bump ID	Signal
80	R1	MODE	R1	MODE
81	R2	NC	R2	NC
82	P3	A5	P3	A5
83	R3	A4	R3	A4
84	P2	NC	P2	NC
85	P4	A2	P4	A2
86	R4	A3	R4	A3
87	N5	NC	N5	NC
88	P6	A1	P6	A1
89	R6	A0	R6	A0
90	*	Int	*	Int

ORDERING INFORMATION

Commercial Range: 0°C to +70°C

V _{DD}	Speed	X36	X18	Package
V _{DD} =3.3V, V _{DDQ} =2.5V/3.3V	250MHz	IS61NLP51236B-250TQ	IS61NLP102418B-250TQ	100 QFP
		IS61NLP51236B-250B3	IS61NLP102418B-250B3	165 BGA
		IS61NLP51236B-250B2	IS61NLP102418B-250B2	119 BGA
		IS61NLP51236B-250TQL	IS61NLP102418B-250TQL	100 QFP, Lead-free
		IS61NLP51236B-250B3L	IS61NLP102418B-250B3L	165 BGA, Lead-free
		IS61NLP51236B-250B2L	IS61NLP102418B-250B2L	119 BGA, Lead-free
	200MHz	IS61NLP51236B-200TQ	IS61NLP102418B-200TQ	100 QFP
		IS61NLP51236B-200B3	IS61NLP102418B-200B3	165 BGA
		IS61NLP51236B-200B2	IS61NLP102418B-200B2	119 BGA
		IS61NLP51236B-200TQL	IS61NLP102418B-200TQL	100 QFP, Lead-free
		IS61NLP51236B-200B3L	IS61NLP102418B-200B3L	165 BGA, Lead-free
		IS61NLP51236B-200B2L	IS61NLP102418B-200B2L	119 BGA, Lead-free
V _{DD} =2.5V, V _{DDQ} =2.5V	250MHz	<i>*Please contact ISSI Marketing</i>		
	200MHz	IS61NVP51236B-200TQ	IS61NVP102418B-200TQ	100 QFP
		IS61NVP51236B-200B3	IS61NVP102418B-200B3	165 BGA
		IS61NVP51236B-200TQL	IS61NVP102418B-200TQL	100 QFP, Lead-free
		IS61NVP51236B-200B3L	IS61NVP102418B-200B3L	165 BGA, Lead-free
V _{DD} =1.8V, V _{DDQ} =1.8V	250MHz	<i>*Please contact ISSI Marketing</i>		
	200MHz	<i>*Please contact ISSI Marketing</i>		

Industrial Range: -40°C to +85°C

V _{DD}	Speed	X36	X18	Package
V _{DD} =3.3V, V _{DDQ} =2.5V/3.3V	250MHz	IS61NLP51236B-250TQI	IS61NLP102418B-250TQI	100 QFP
		IS61NLP51236B-250B3I	IS61NLP102418B-250B3I	165 BGA
		IS61NLP51236B-250B2I	IS61NLP102418B-250B2I	119 BGA
		IS61NLP51236B-250TQLI	IS61NLP102418B-250TQLI	100 QFP, Lead-free
		IS61NLP51236B-250B3LI	IS61NLP102418B-250B3LI	165 BGA, Lead-free
		IS61NLP51236B-250B2LI	IS61NLP102418B-250B2LI	119 BGA, Lead-free
	200MHz	IS61NLP51236B-200TQI	IS61NLP102418B-200TQI	100 QFP
		IS61NLP51236B-200B3I	IS61NLP102418B-200B3I	165 BGA
		IS61NLP51236B-200B2I	IS61NLP102418B-200B2I	119 BGA
		IS61NLP51236B-200TQLI	IS61NLP102418B-200TQLI	100 QFP, Lead-free
		IS61NLP51236B-200B3LI	IS61NLP102418B-200B3LI	165 BGA, Lead-free
		IS61NLP51236B-200B2LI	IS61NLP102418B-200B2LI	119 BGA, Lead-free
V _{DD} =2.5V, V _{DDQ} =2.5V	250MHz	<i>*Please contact ISSI Marketing</i>		
	200MHz	IS61NVP51236B-200TQI	IS61NVP102418B-200TQI	100 QFP
		IS61NVP51236B-200B3I	IS61NVP102418B-200B3I	165 BGA
		IS61NVP51236B-200TQLI	IS61NVP102418B-200TQLI	100 QFP, Lead-free
		IS61NVP51236B-200B3LI	IS61NVP102418B-200B3LI	165 BGA, Lead-free
V _{DD} =1.8V, V _{DDQ} =1.8V	250MHz	<i>*Please contact ISSI Marketing</i>		
	200MHz	<i>*Please contact ISSI Marketing</i>		

ORDERING INFORMATION

Automotive (A3) Range: -40°C to +125°C

V _{DD}	Speed	X36	Package
V _{DD} =3.3V, V _{DDQ} =2.5V/3.3V	250MHz	IS64NLP51236B-250TQLA3	100 QFP, Lead-free
		IS64NLP51236B-250B3LA3	165 BGA, Lead-free
		IS64NLP51236B-250B2LA3	119 BGA, Lead-free
	200MHz	IS64NLP51236B-200TQLA3	100 QFP, Lead-free
		IS64NLP51236B-200B3LA3	165 BGA, Lead-free
		IS64NLP51236B-200B2LA3	119 BGA, Lead-free

**For all other voltages and options in automotive grade, please contact ISSI.*

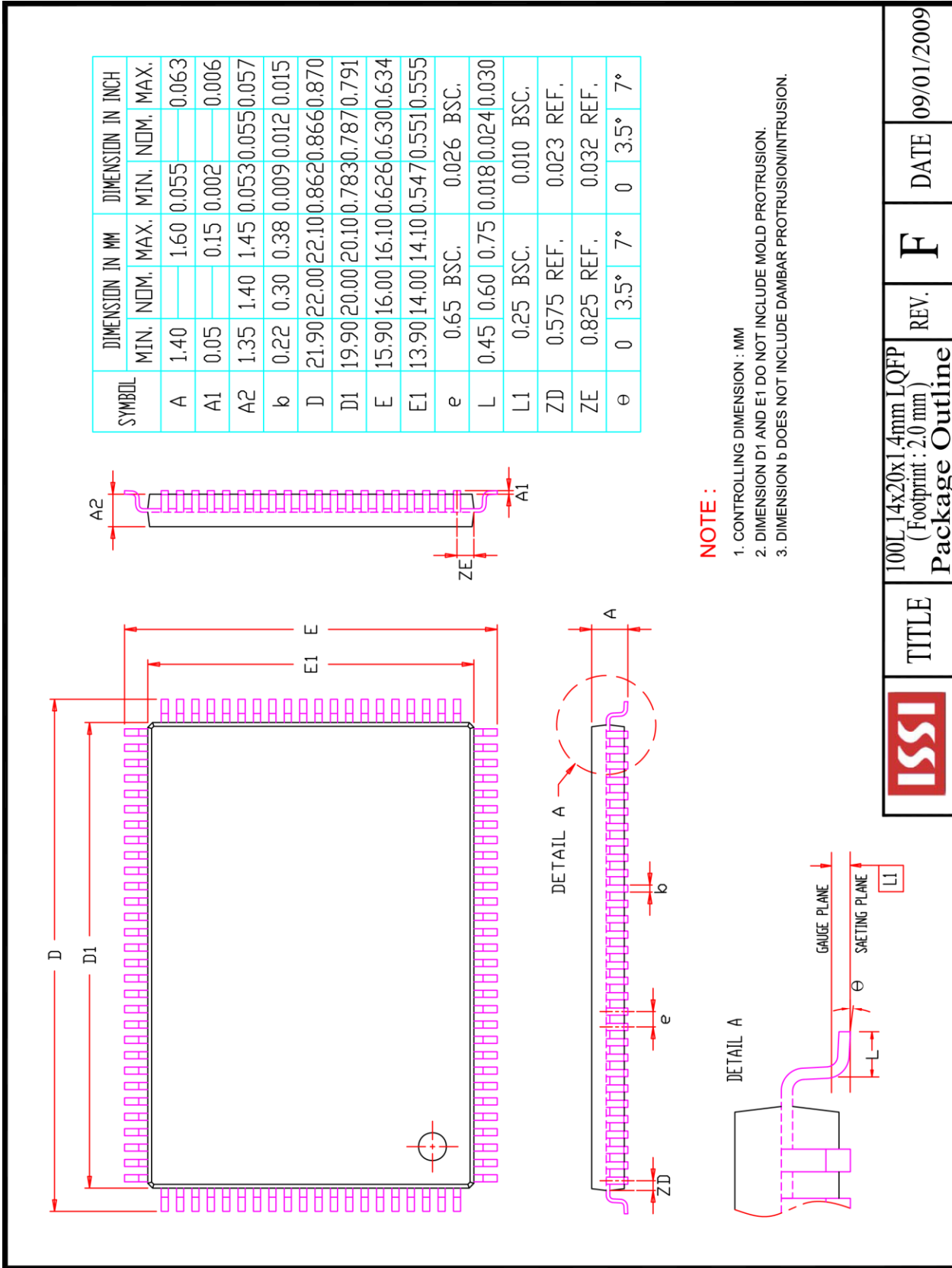

	TITLE	REV.	DATE
	100L 14x20x1.4mm LQFP (Footprint : 2.0 mm) Package Outline	F	09/01/2009

280-600-011 REV. A

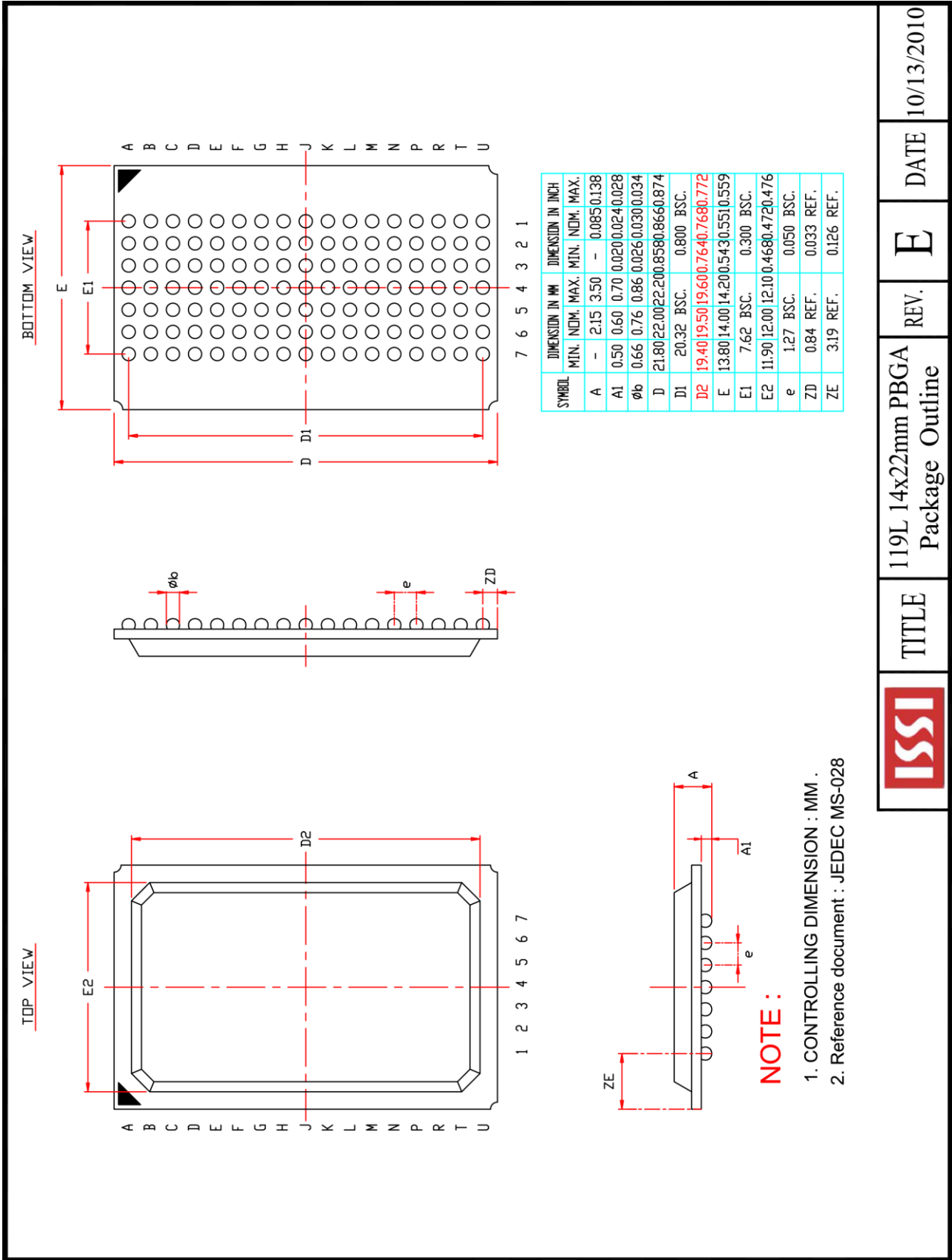

	TITLE	REV.	DATE
	119L 14x22mm PBGA Package Outline	E	10/13/2010

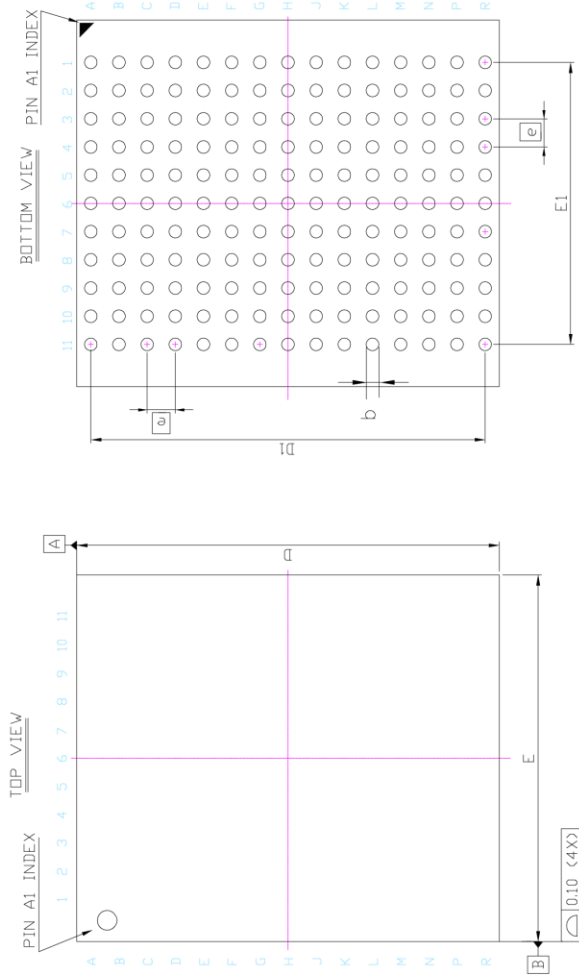

SYM.	DIMENSION (mm)			DIMENSION (inch)		
	MIN.	NOM.	MAX.	MIN.	NOM.	MAX.
A	—	—	1.20	—	—	0.047
A1	0.25	0.35	0.40	0.010	0.014	0.016
A2	—	0.79	—	—	0.031	—
b	0.40	0.45	0.50	0.016	0.018	0.020
D	14.90	15.00	15.10	0.587	0.591	0.594
D1	13.90	14.00	14.10	0.547	0.551	0.555
E	12.90	13.00	13.10	0.508	0.512	0.516
E1	9.90	10.00	10.10	0.390	0.394	0.398
ⓔ	1.00 BSC			0.039 BSC		

NOTE :

1. CONTROLLING DIMENSION : MM .

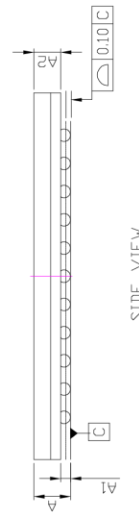

	TITLE	165L 13x15mm TF-BGA Package Outline	REV. B	DATE 08/28/2008
--	-------	--	--------	-----------------

X-ON Electronics

Largest Supplier of Electrical and Electronic Components

Click to view similar products for [SRAM](#) category:

Click to view products by [ISSI](#) manufacturer:

Other Similar products are found below :

[CY6116A-35DMB](#) [CY7C1049GN-10VXI](#) [CY7C128A-45DMB](#) [GS8161Z36DD-200I](#) [GS88237CB-200I](#) [RMLV0408EGSB-4S2#AA0](#)
[IDT70V5388S166BG](#) [IS64WV3216BLL-15CTLA3](#) [IS66WVE4M16ECLL-70BLI](#) [PCF8570P](#) [K6F2008V2E-LF70000](#) [K6T4008C1B-GB70](#)
[CY7C1353S-100AXC](#) [AS6C8016-55BIN](#) [AS7C164A-15PCN](#) [515712X](#) [IDT71V67603S133BG](#) [IS62WV51216EBLL-45BLI](#)
[IS63WV1288DBLL-10HLI](#) [IS66WVE2M16ECLL-70BLI](#) [IS66WVE4M16EALL-70BLI](#) [IS62WV6416DBLL-45BLI](#) [IS61WV102416DBLL-](#)
[10TLI](#) [CY7C1381KV33-100AXC](#) [CY7C1381KVE33-133AXI](#) [8602501XA](#) [5962-3829425MUA](#) [5962-3829430MUA](#) [5962-8855206YA](#)
[5962-8866201YA](#) [5962-8866204TA](#) [5962-8866206MA](#) [5962-8866208UA](#) [5962-8872502XA](#) [5962-9062007MXA](#) [5962-9161705MXA](#)
[GS882Z18CD-150I](#) [M38510/28902BVA](#) [8413202RA](#) [5962-9161708MYA](#) [5962-8971203XA](#) [5962-8971202ZA](#) [5962-8872501LA](#) [5962-](#)
[8866208YA](#) [5962-8866205YA](#) [5962-8866205UA](#) [5962-8866203YA](#) [5962-8855202YA](#) [5962-8751309VA](#) [5962-8687519XA](#)