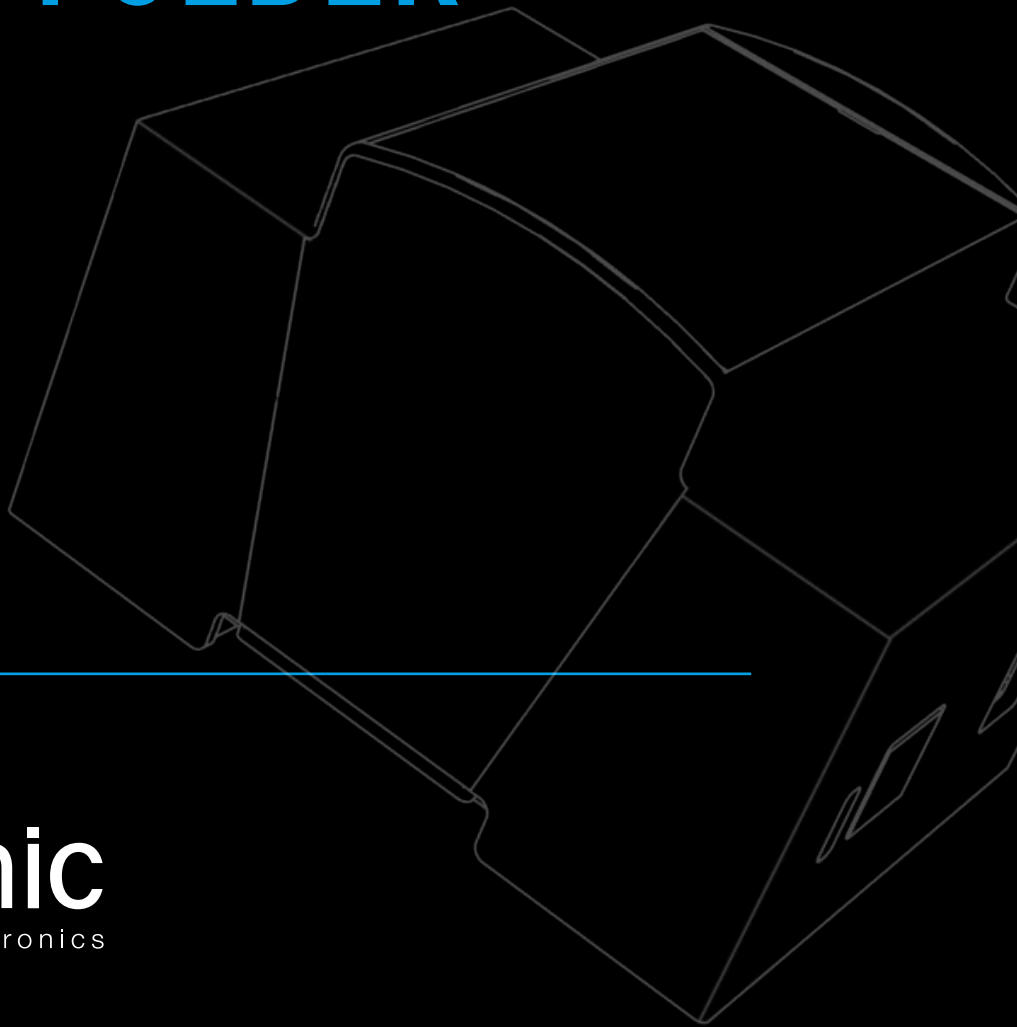

A WORLD OF ENCLOSURES

EMBEDDED BOX

SHORT FOLDER

www.italtronic.com

italtronic
enclosures for electronics



BEAGLEBONE BLACK



25.0410000.BGB

Contenitore kit completo 4M XTS/4M XTS complete enclosure kit

Pag. 16



33.0414000.BGB

Contenitore kit completo 4M XTS COMPACT/4M XTS COMPACT complete enclosure kit

Pag. 16



25.0610000.BGB

Contenitore kit completo 6M XTS/6M XTS complete enclosure kit

Pag. 17



33.0614000.BGB

Contenitore kit completo 6M XTS COMPACT/6M XTS COMPACT complete enclosure kit

Pag. 17

BEAGLEBONE GREEN



25.0410000.BGG

Contenitore kit completo 4M XTS/4M XTS complete enclosure kit

Pag. 19



33.0414000.BGG

Contenitore kit completo 4M XTS COMPACT/4M XTS COMPACT complete enclosure kit

Pag. 19



25.0610000.BGG

Contenitore kit completo 6M XTS/6M XTS complete enclosure kit

Pag. 21



33.0614000.BGG

Contenitore kit completo 6M XTS COMPACT/6M XTS COMPACT complete enclosure kit

Pag. 21

BEAGLEBONE GREEN WIRELESS



25.0410000.BGW

Contenitore kit completo 4M XTS/4M XTS complete enclosure kit

Pag. 23



33.0414000.BGW

Contenitore kit completo 4M XTS COMPACT/4M XTS COMPACT complete enclosure kit

Pag. 23



25.0610000.BGW

Contenitore kit completo 6M XTS/6M XTS complete enclosure kit

Pag. 25



33.0614000.BGW

Contenitore kit completo 6M XTS COMPACT/6M XTS COMPACT complete enclosure kit

Pag. 25

RASPBERRY PI

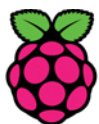

®



25.0410000.RPI

Contenitore kit completo 4M XTS/4M XTS complete enclosure kit

Pag. 27









RaspberryPi

EMBEDDED BOX

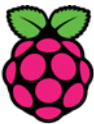
RASPBERRY PI 4

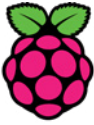
		25.0410000.RP4	Contentitore kit completo 4M XTS/4M XTS complete enclosure kit	Pag. 41
RaspberryPi		33.0414000.RP4	Contentitore kit completo 4M XTS COMPACT/4M XTS COMPACT complete enclosure kit	Pag. 41
		25.0610000.RP4	Contentitore kit completo 6M XTS/6M XTS complete enclosure kit	Pag. 43
RaspberryPi		33.0614000.RP4	Contentitore kit completo 6M XTS COMPACT/6M XTS COMPACT complete enclosure kit	Pag. 43

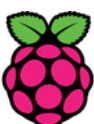
RASPBERRY PI/PI B+/PI 3 / PI 4 INDUSTRIAL

		10.0012225.RPI	Contentitore kit completo 22,5 railbox/22,5 railbox enclosure kit	Pag. 45
RaspberryPi		10.0052450.RPI	Contentitore kit completo 45 railbox/45 railbox complete enclosure kit	Pag. 45
		10.0012225.RMB	Contentitore kit completo 22,5 railbox/22,5 railbox complete enclosure kit	Pag. 46
RaspberryPi		10.0052450.RMB	Contentitore kit completo 45 railbox/45 railbox complete enclosure kit	Pag. 46
		10.0012225.RP3	Contentitore kit completo 22,5 railbox/22,5 railbox enclosure kit	Pag. 47
RaspberryPi		10.0052450.RP3	Contentitore kit completo 45 railbox/45 railbox complete enclosure kit	Pag. 47
		10.0012225.RP4	Contentitore kit completo 22,5 railbox/22,5 railbox enclosure kit	Pag. 48
RaspberryPi		10.0052450.RP4	Contentitore kit completo 45 railbox/45 railbox complete enclosure kit	Pag. 48

ASSEMBLAGGIO/DISASSEMBLAGGIO

ASSEMBLY/DISASSEMBLY

ARDUINO YUN

ARDUINO YUN

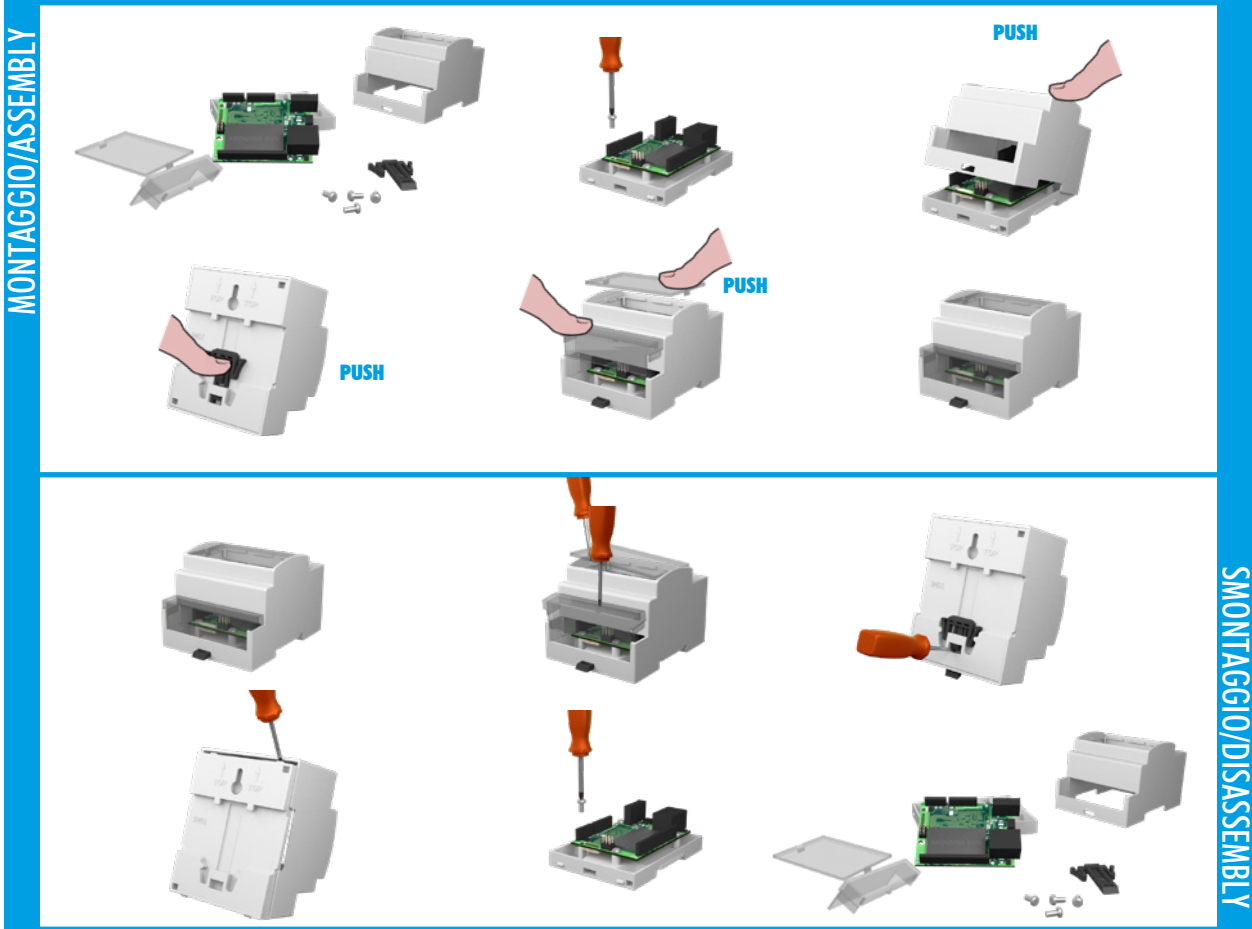

ARDUINO YUN compact

ARDUINO YUN compact

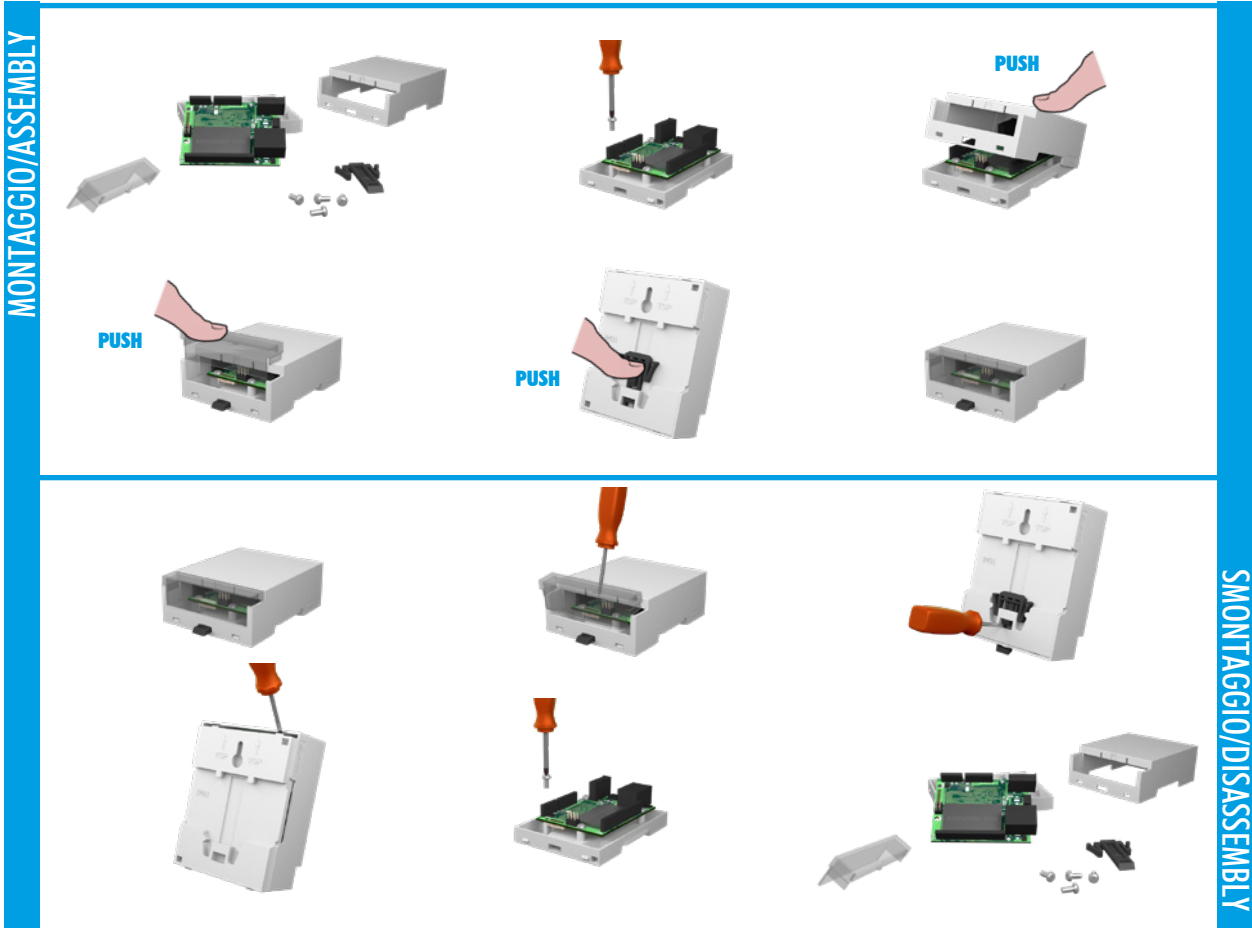

ARDUINO YUN

CARATTERISTICHE GENERALI

Contenitori per ARDUINO YUN per guida DIN (EN 60715)

Materiale: PC/ABS autoestinguente UL94V-0
Colore: Grigio

CONTENITORE PER GUIDA DIN (EN 60715)

Italtronic propone una nuova linea di contenitori industriali e per HOME & BUILDING AUTOMATION adatti a contenere le più note schede elettroniche EMBEDDED.



ARDUINO YUN

GENERAL FEATURES

ARDUINO YUN for rail din (EN 60715) application.

Material: PC/ABS self-extinguishing UL94V-0
Colour: Grey

DIN RAIL (EN 60715) ENCLOSURE

Italtronic propose a new industrial and HOME & BUILDING AUTOMATION enclosures useful to contain the more famous EMBEDDED electronic boards.

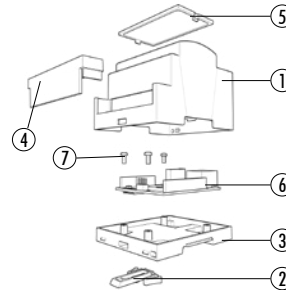

Descrizione/Description:

- 1) Corpo contenitore/Body enclosure
- 2) Gancio/Hook
- 3) Base/Base
- 4) Coprimorsetto/Terminal cover
- 5) Pannello/Panel
- 6) Circuito stampato*/Pcb*
- 7) Viti/Screws

* Non incluso / Not included

Contenitore Completo/Complete Enclosure

CODICE / CODE	COLORE / COLOUR	DESCRIZIONE/DESCRIPTION	FORMA/SHAPE
25.0612000.YUN	Grigio/Grey	Kit 6M XTS Arduino YUN /6M XTS Arduino YUN kit	B/B

Composizione Kit: il Kit comprende corpo, base, gancio, pannello trasparent., 2 coprimorsetti, 3 viti.

Kit composition: kit includes body enclosure, base, hook, transparent panel, 2 terminal cover, 3 screws.

DIMENSIONI B/B DIMENSIONS: 90 mm
DIMENSIONI L/L DIMENSIONS: 106,5 mm
DIMENSIONI H/H DIMENSIONS: 55 mm

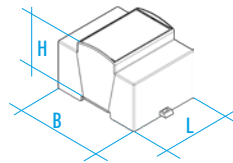

CONFEZIONE N° PCS/KIT: 25
PACKAGING N° PCS/KIT:

PESO DELLA CONFEZIONE: 3,5 kg
PACKAGING WEIGHT:

MINIMO ACQUISTABILE: 1
MINIMUM ORDER:

PESO DEL PEZZO KIT: 90 g
KIT WEIGHT:

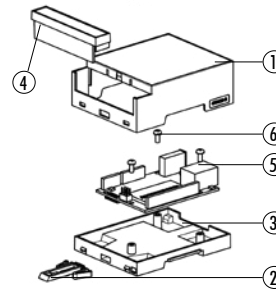

Descrizione/Description:

- 1) Corpo contenitore/Body enclosure
- 2) Gancio/Hook
- 3) Base/Base
- 4) Coprimorsetto/Terminal cover
- 5) Circuito stampato*/Pcb*
- 6) Viti/Screws

* Non incluso / Not included

Contenitore Completo/Complete Enclosure

CODICE / CODE	COLORE / COLOUR	DESCRIZIONE/DESCRIPTION	FORMA/SHAPE
33.0606000.YUN	Grigio/Grey	Kit 6M XTS COMPACT Arduino YUN /6M XTS COMPACT Arduino YUN kit	B/B

Composizione Kit: il Kit comprende corpo, base, gancio, 2 coprimorsetti trasparenti, 3 viti

Kit composition: kit includes body enclosure, base, hook, 2 transparent terminal cover, 3 screws.

DIMENSIONI B/B DIMENSIONS: 90 mm
DIMENSIONI L/L DIMENSIONS: 106,5 mm
DIMENSIONI H/H DIMENSIONS: 32 mm

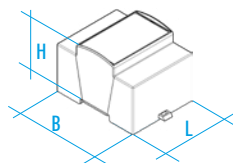

CONFEZIONE N° PCS/KIT: 50
PACKAGING N° PCS/KIT:

PESO DELLA CONFEZIONE: 4,75 kg
PACKAGING WEIGHT:

MINIMO ACQUISTABILE: 1
MINIMUM ORDER:

PESO DEL PEZZO KIT: 75 g
KIT WEIGHT:

TIPO GUIDA DIN/DIN RAIL TYPE: Norme EN 60715/EN 60715 NORM

NORMA CONTENITORE/ENCLOSURE STANDARD: Norme DIN 43880/43880 DIN NORM



ARDUINO MEGA

CARATTERISTICHE GENERALI

Contenitore per ARDUINO MEGA per guida DIN (EN 60715)

Materiale: PC/ABS autoestinguente UL94V-0
Colore: Grigio

CONTENITORE PER GUIDA DIN (EN 60715)

Italtronic propone una nuova linea di contenitori industriali e per HOME & BUILDING AUTOMATION adatti a contenere le più note schede elettroniche EMBEDDED.



ARDUINO MEGA

GENERAL FEATURES

ARDUINO MEGA for rail din (EN 60715) application.

Material: PC/ABS self-extinguishing UL94V-0
Colour: Grey

DIN RAIL (EN 60715) ENCLOSURE

Italtronic propose a new industrial and HOME & BUILDING AUTOMATION enclosures useful to contain the more famous EMBEDDED electronic boards.

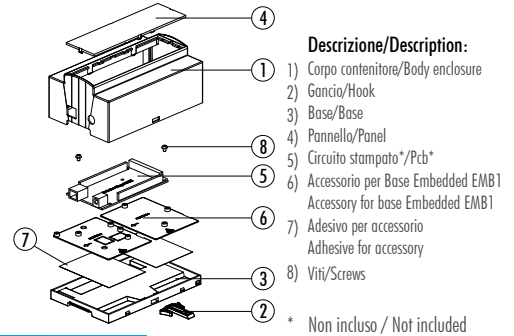

Contenitore Completo/Complete Enclosure

CODICE / CODE	COLORE / COLOUR	DESCRIZIONE/DESCRIPTION	FORMA/SHAPE
25.0810000.MEGA	Grigio/Grey	Kit 8M XTS Arduino MEGA /8M XTS Arduino MEGA kit	C/C

Composizione Kit: il Kit comprende corpo, base, gancio, pannello trasp., 2 accessori base embedded, 2 adesivi, 2 viti.

Kit composition: kit includes body enclosure, base, hook, transparent panel, 2 accessories for base embedded, 2 adhesives for accessories, 2 screws.

DIMENSIONI B/B DIMENSIONS: 90 mm
DIMENSIONI L/L DIMENSIONS: 142,5 mm
DIMENSIONI H/H DIMENSIONS: 55 mm

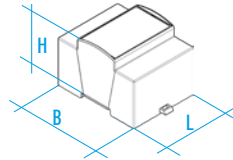

CONFEZIONE N° PCS/KIT: 25
PACKAGING N° PCS/KIT: 25

PESO DELLA CONFEZIONE: 4,25 kg
PACKAGING WEIGHT: 4,25 kg

MINIMO ACQUISTABILE: 1
MINIMUM ORDER: 1

PESO DEL PEZZO KIT: 130 g
KIT WEIGHT: 130 g

TIPO GUIDA DIN/DIN RAIL TYPE: Norme EN 60715/EN 60715 NORM

NORMA CONTENITORE/ENCLOSURE STANDARD: Norme DIN 43880/43880 DIN NORM



ARDUINO UNO E 101 CARATTERISTICHE GENERALI

Contenitore per ARDUINO UNO e 101 per guida DIN (EN 60715)

Materiale: PC/ABS autoestinguento UL94V-0

Colore: Grigio

CONTENITORE PER GUIDA DIN (EN 60715)

Italtronic propone una nuova linea di contenitori industriali e per HOME & BUILDING AUTOMATION adatti a contenere le più note schede elettroniche EMBEDDED.



ARDUINO UNO AND 101 GENERAL FEATURES

ARDUINO UNO and 101 for rail din (EN 60715) application

Material: PC/ABS self-extinguishing UL94V-0

Colour: Grey

DIN RAIL (EN 60715) ENCLOSURE

Italtronic propose a new industrial and HOME & BUILDING AUTOMATION enclosures useful to contain the more famous EMBEDDED electronic boards

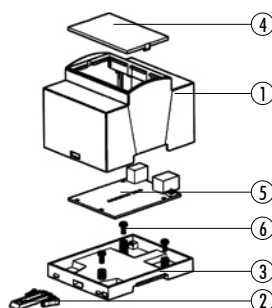

Descrizione/Description:

- 1) Corpo contenitore/Body enclosure
- 2) Gancio/Hook
- 3) Base/Base
- 4) Pannello/Panel
- 5) Circuito stampato*/Pcb*
- 6) Viti/Screws

* Non incluso / Not included

Contenitore Completo/Complete Enclosure

CODICE / CODE	COLORE / COLOUR	DESCRIZIONE/DESCRIPTION	FORMA/SHAPE
25.0410000.UNO	Grigio/Grey	kit 4M XTS Arduino UNO e 101/4M XTS Arduino UNO and 101 kit	C/C

Composizione Kit: il Kit comprende corpo, base, gancio, pannello trasp., 3 viti.

Kit composition: kit includes body enclosure, base, hook, transparent panel, 3 screws.

DIMENSIONI B/B DIMENSIONS: 90 mm

DIMENSIONI L/L DIMENSIONS: 71 mm

DIMENSIONI H/H DIMENSIONS: 55 mm

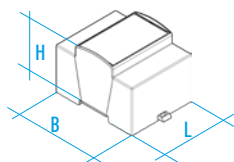

CONFEZIONE N° PCS/KIT: 50
PACKAGING N° PCS/KIT:

PESO DELLA CONFEZIONE: 4,5 kg
PACKAGING WEIGHT:

MINIMO ACQUISTABILE: 1
MINIMUM ORDER:

PESO DEL PEZZO KIT: 70 g
KIT WEIGHT:

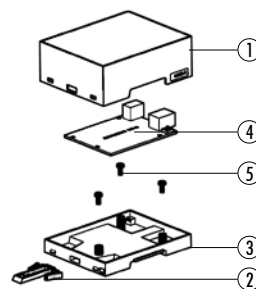
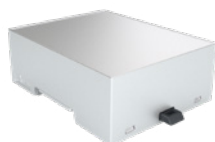

Descrizione/Description:

- 1) Corpo contenitore/Body enclosure
- 2) Gancio/Hook
- 3) Base/Base
- 4) Circuito stampato*/Pcb*
- 5) Viti/Screws

* Non incluso / Not included

Contenitore Completo/Complete Enclosure

CODICE / CODE	COLORE / COLOUR	DESCRIZIONE/DESCRIPTION	FORMA/SHAPE
33.0414000.UNO	Grigio/Grey	kit 4M XTS COMPACT Arduino UNO e 101/4M XTS COMPACT Arduino UNO and 101 kit	C/C

Composizione Kit: il Kit comprende corpo, base, gancio, 3 viti.

Kit composition: kit includes body enclosure, base, hook, 3 screws.

DIMENSIONI B/B DIMENSIONS: 90 mm

DIMENSIONI L/L DIMENSIONS: 71 mm

DIMENSIONI H/H DIMENSIONS: 32 mm

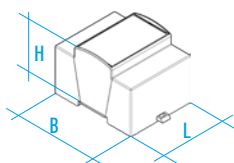

CONFEZIONE N° PCS/KIT: 100
PACKAGING N° PCS/KIT:

PESO DELLA CONFEZIONE: 6 kg
PACKAGING WEIGHT:

MINIMO ACQUISTABILE: 1
MINIMUM ORDER:

PESO DEL PEZZO KIT: 50 g
KIT WEIGHT:

TIPO GUIDA DIN/DIN RAIL TYPE: Norme EN 60715/EN 60715 NORM

NORMA CONTENITORE/ENCLOSURE STANDARD: Norme DIN 43880/43880 DIN NORM



ARDUINO ZERO

CARATTERISTICHE GENERALI

Contenitori per ARDUINO ZERO per guida DIN (EN 60715)

Materiale: PC/ABS autoestinguente UL94V-0
Colore: Grigio

CONTENITORE PER GUIDA DIN (EN 60715)

Italtronic propone una nuova linea di contenitori industriali e per HOME & BUILDING AUTOMATION adatti a contenere le più note schede elettroniche EMBEDDED.



ARDUINO ZERO

GENERAL FEATURES

ARDUINO ZERO for rail din (EN 60715) application.

Material: PC/ABS self-extinguishing UL94V-0
Colour: Grey

DIN RAIL (EN 60715) ENCLOSURE

Italtronic propose a new industrial and HOME & BUILDING AUTOMATION enclosures useful to contain the more famous EMBEDDED electronic boards.

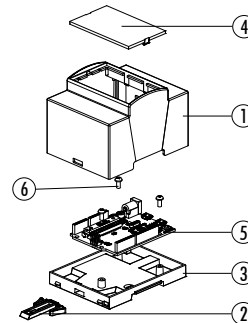

Descrizione/Description:

- 1) Corpo contenitore/Body enclosure
- 2) Gancio/Hook
- 3) Base/Base
- 4) Pannello/Panel
- 5) Circuito stampato*/Pcb*
- 6) Viti/Screws

* Non incluso / Not included

Contenitore Completo/Complete Enclosure

CODICE / CODE	COLORE / COLOUR	DESCRIZIONE/DESCRIPTION	FORMA/SHAPE
25.0410000.ZERO	Grigio/Grey	Kit 4M XTS Arduino ZERO /4M XTS Arduino ZERO kit	C/C

Composizione Kit: il Kit comprende corpo, base, gancio, pannello trasparente, 3 viti.

Kit composition: kit includes body enclosure, base, hook, transparent panel, 3 screws.

DIMENSIONI B/B DIMENSIONS: 90 mm

DIMENSIONI L/L DIMENSIONS: 74 mm

DIMENSIONI H/H DIMENSIONS: 55 mm

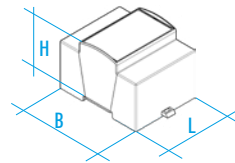

CONFEZIONE N° PCS/KIT: 50
PACKAGING N° PCS/KIT:

PESO DELLA CONFEZIONE: 4,5 kg
PACKAGING WEIGHT:

MINIMO ACQUISTABILE: 1
MINIMUM ORDER:

PESO DEL PEZZO KIT: 70 g
KIT WEIGHT:

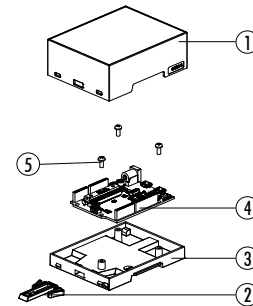

Descrizione/Description:

- 1) Corpo contenitore/Body enclosure
- 2) Gancio/Hook
- 3) Base/Base
- 4) Circuito stampato*/Pcb*
- 5) Viti/Screws

* Non incluso / Not included

Contenitore Completo/Complete Enclosure

CODICE / CODE	COLORE / COLOUR	DESCRIZIONE/DESCRIPTION	FORMA/SHAPE
33.0414000.ZERO	Grigio/Grey	Kit 4M XTS COMPACT Arduino ZERO /4M XTS COMPACT Arduino ZERO kit	C/C

Composizione Kit: il Kit comprende corpo, base, gancio, pannello trasparente, 3 viti.

Kit composition: kit includes body enclosure, base, hook, transparent panel, 3 screws.

DIMENSIONI B/B DIMENSIONS: 90 mm

DIMENSIONI L/L DIMENSIONS: 74 mm

DIMENSIONI H/H DIMENSIONS: 32 mm

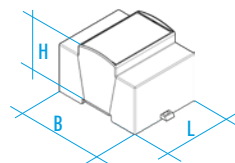

CONFEZIONE N° PCS/KIT: 100
PACKAGING N° PCS/KIT:

PESO DELLA CONFEZIONE: 6 kg
PACKAGING WEIGHT:

MINIMO ACQUISTABILE: 1
MINIMUM ORDER:

PESO DEL PEZZO KIT: 50 g
KIT WEIGHT:

TIPO GUIDA DIN/DIN RAIL TYPE: Norme EN 60715/EN 60715 NORM

NORMA CONTENITORE/ENCLOSURE STANDARD: Norme DIN 43880/43880 DIN NORM



BEAGLEBONE BLACK

CARATTERISTICHE GENERALI

Contenitore per BEAGLEBONE BLACK per guida DIN (EN 60715)

Material: PC/ABS autoestinguente UL94V-0
Colore: Grigio

CONTENITORE PER GUIDA DIN (EN 60715)

Italtronic propone una nuova linea di contenitori industriali e per HOME & BUILDING AUTOMATION adatti a contenere le più note schede elettroniche EMBEDDED.



BEAGLEBONE BLACK

GENERAL FEATURES

BEAGLEBONE BLACK for rail din (EN 60715) application.

Material: PC/ABS self-extinguishing UL94V-0
Colour: Grey

DIN RAIL (EN 60715) ENCLOSURE

Italtronic propose a new industrial and HOME & BUILDING AUTOMATION enclosures useful to contain the more famous EMBEDDED electronic boards.

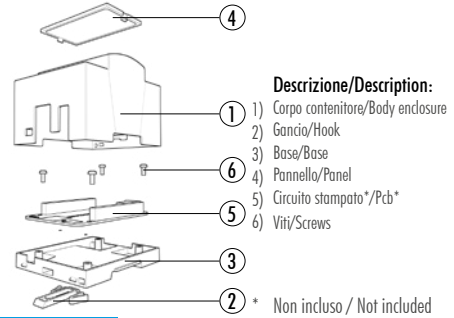

Contenitore Completo/Complete Enclosure

CODICE / CODE	COLORE / COLOUR	DESCRIZIONE/DESCRIPTION	FORMA/SHAPE
25.0410000.BGB	Grigio/Grey	Kit 4M XTS Beaglebone BLACK/4M XTS Beaglebone BLACK kit	C/C

Composizione Kit: il Kit comprende corpo, base, gancio, pannello trasparente, 2 viti.

Kit composition: kit includes body enclosure, base, hook, transparent panel, 2 screws.

DIMENSIONI B/B DIMENSIONS: 90 mm
DIMENSIONI L/L DIMENSIONS: 71 mm
DIMENSIONI H/H DIMENSIONS: 55 mm

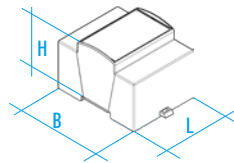

CONFEZIONE N° PCS/KIT: PACKAGING N° PCS/KIT:	50	PESO DELLA CONFEZIONE: PACKAGING WEIGHT:	4,5 kg	MINIMO ACQUISTABILE: MINIMUM ORDER:	1	PESO DEL PEZZO KIT: KIT WEIGHT:	70 g
--	-----------	--	---------------	---	----------	---	-------------



Contenitore Completo/Complete Enclosure

CODICE / CODE	COLORE / COLOUR	DESCRIZIONE/DESCRIPTION	FORMA/SHAPE
33.0414000.BGB	Grigio/Grey	Kit 4M XTS COMPACT Beaglebone BLACK/4M XTS COMPACT Beaglebone BLACK kit	C/C

Composizione Kit: il Kit comprende corpo, base, gancio, 2 viti.

Kit composition: kit includes body enclosure, base, hook, 2 screws.

DIMENSIONI B/B DIMENSIONS: 90
DIMENSIONI L/L DIMENSIONS: 71
DIMENSIONI H/H DIMENSIONS: 32

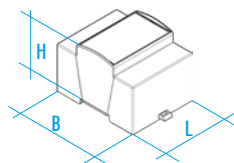

CONFEZIONE N° PCS/KIT: PACKAGING N° PCS/KIT:	100	PESO DELLA CONFEZIONE: PACKAGING WEIGHT:	6 kg	MINIMO ACQUISTABILE: MINIMUM ORDER:	1	PESO DEL PEZZO KIT: KIT WEIGHT:	50 g
--	------------	--	-------------	---	----------	---	-------------

TIPO GUIDA DIN/DIN RAIL TYPE: Norme EN 60715/EN 60715 NORM

NORMA CONTENITORE/ENCLOSURE STANDARD: Norme DIN 43880/43880 DIN NORM



ASSEMBLAGGIO/DISASSEMBLAGGIO

ASSEMBLY/DISASSEMBLY

BEAGLEBONE GREEN

BEAGLEBONE GREEN

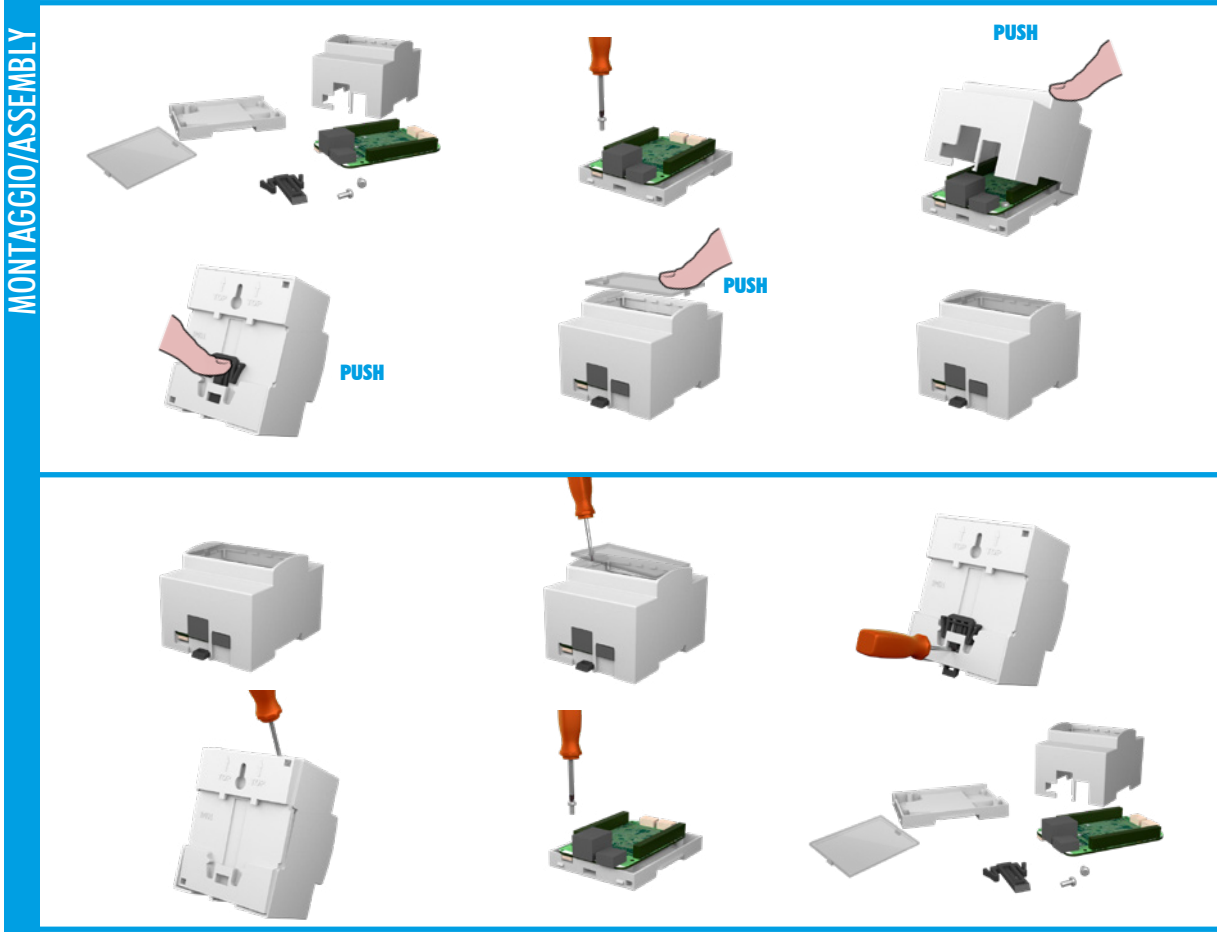

BEAGLEBONE GREEN compact

BEAGLEBONE GREEN compact

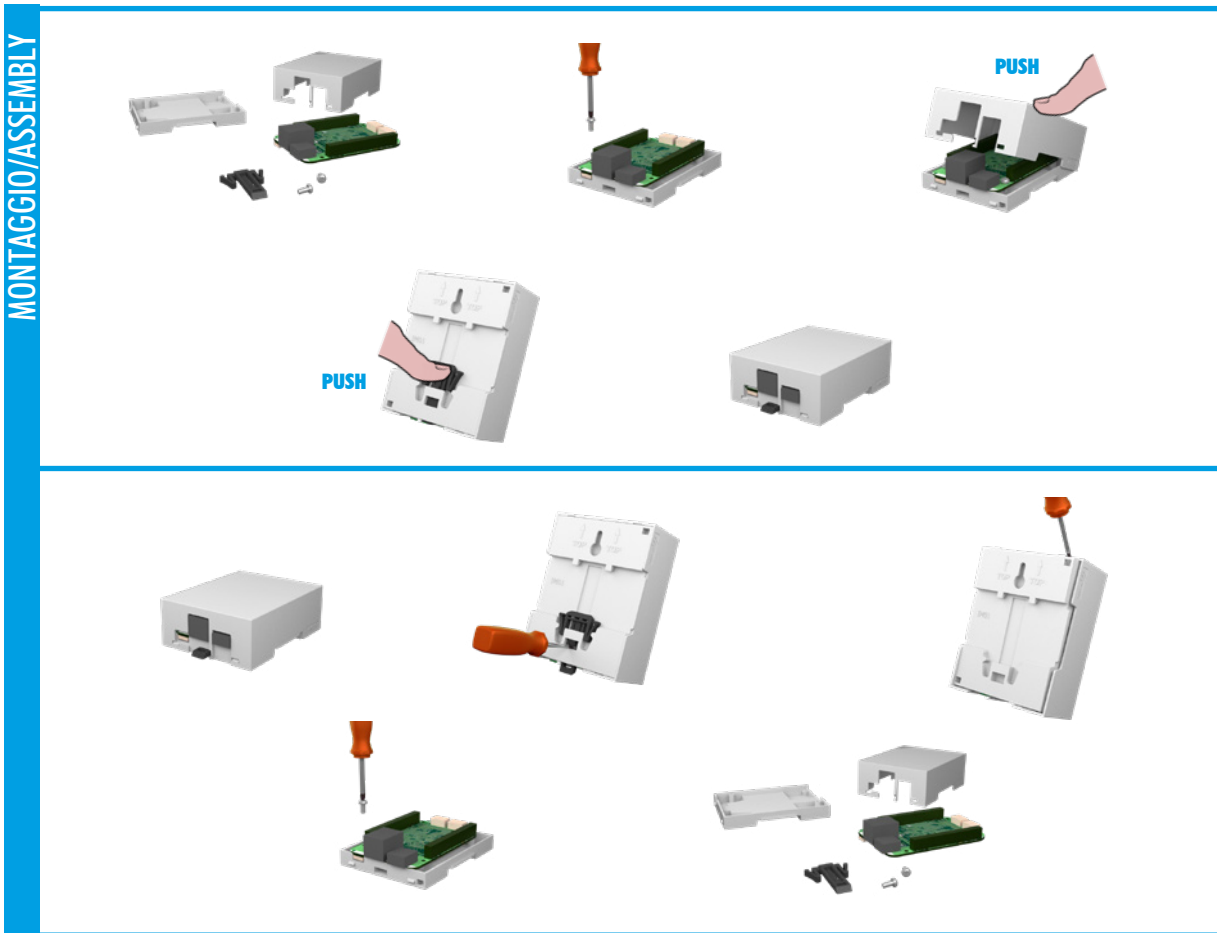

MONTAGGIO/ASSEMBLY

SMONTAGGIO/DISASSEMBLY

MONTAGGIO/ASSEMBLY

SMONTAGGIO/DISASSEMBLY

ASSEMBLAGGIO/DISASSEMBLAGGIO

ASSEMBLY/DISASSEMBLY

BEAGLEBONE GREEN

BEAGLEBONE GREEN

MONTAGGIO/ASSEMBLY

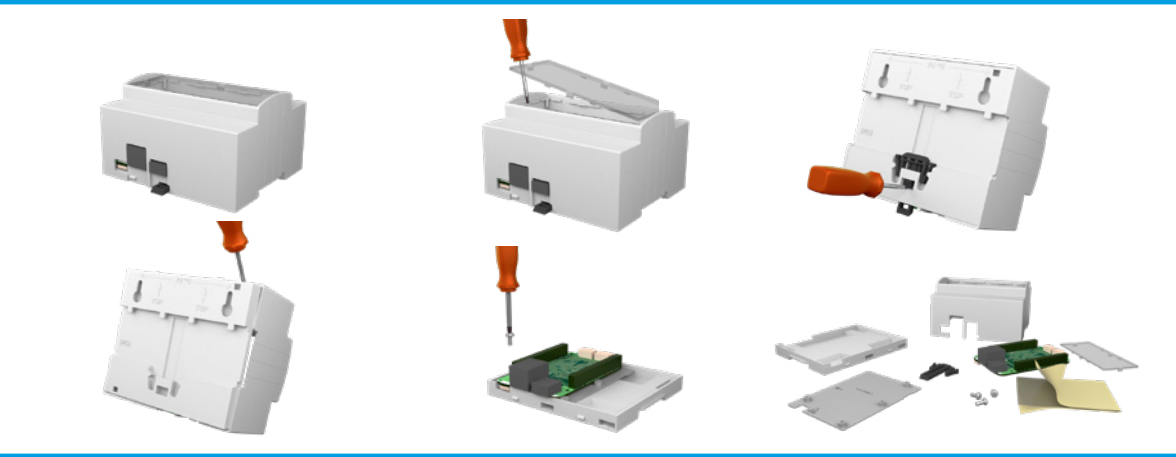
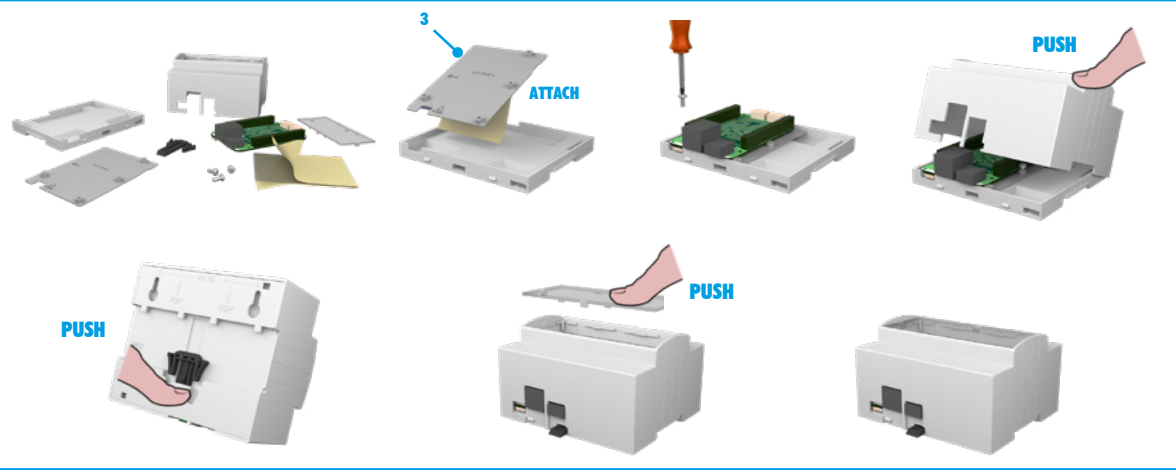

SMONTAGGIO/DISASSEMBLY

BEAGLEBONE GREEN compact

BEAGLEBONE GREEN compact

MONTAGGIO/ASSEMBLY

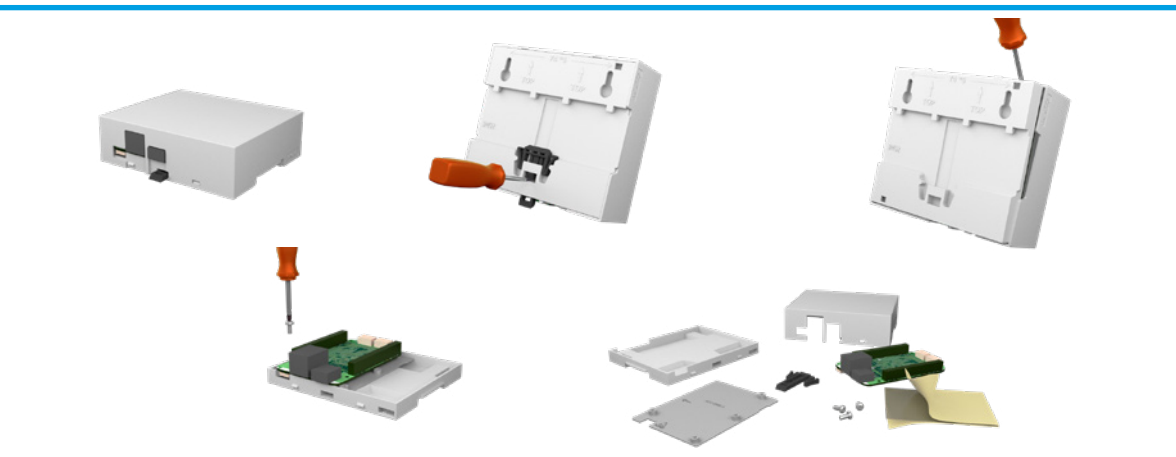
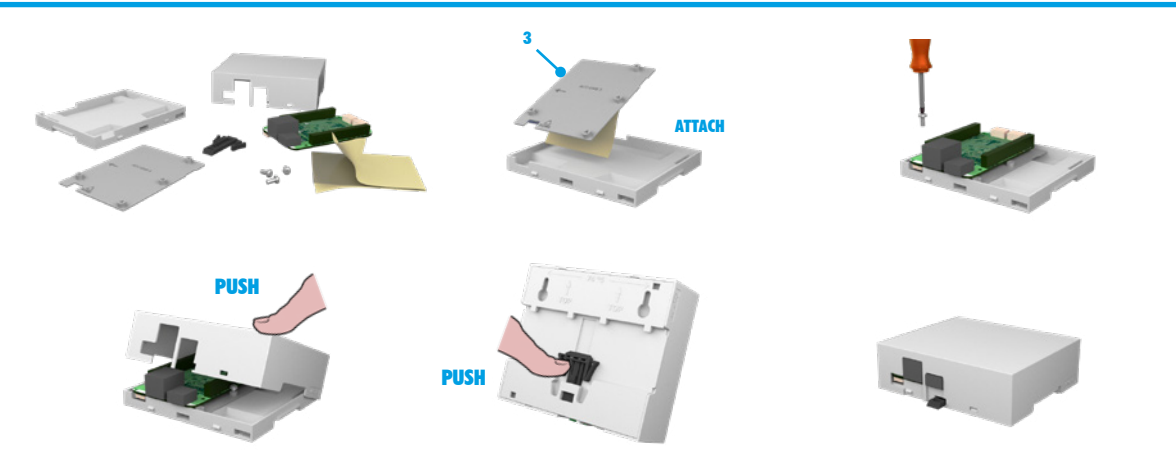

SMONTAGGIO/DISASSEMBLY

ASSEMBLAGGIO/DISASSEMBLAGGIO

ASSEMBLY/DISASSEMBLY

BEAGLEBONE GREEN WIRELESS

BEAGLEBONE GREEN WIRELESS

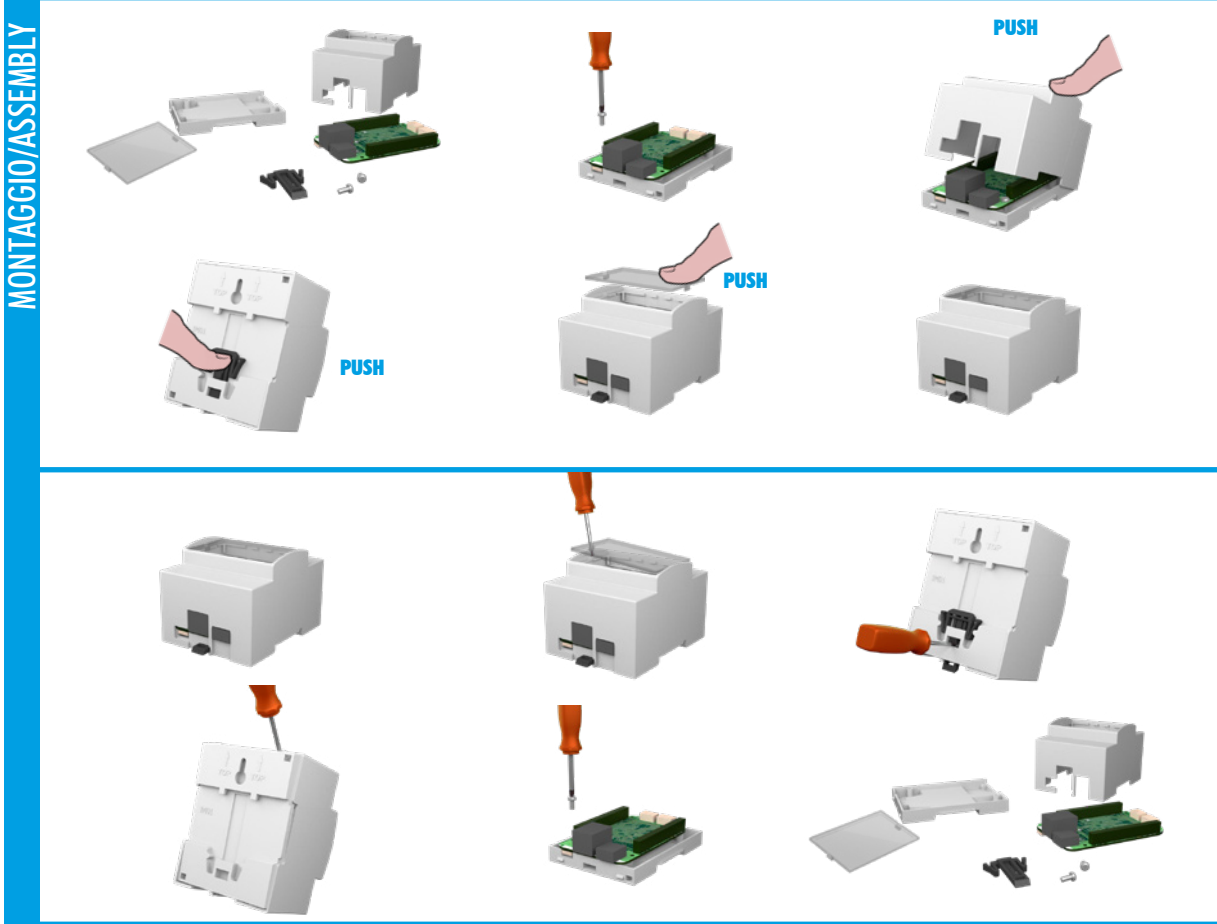

BEAGLEBONE GREEN WIRELESS compact

BEAGLEBONE GREEN WIRELESS compact

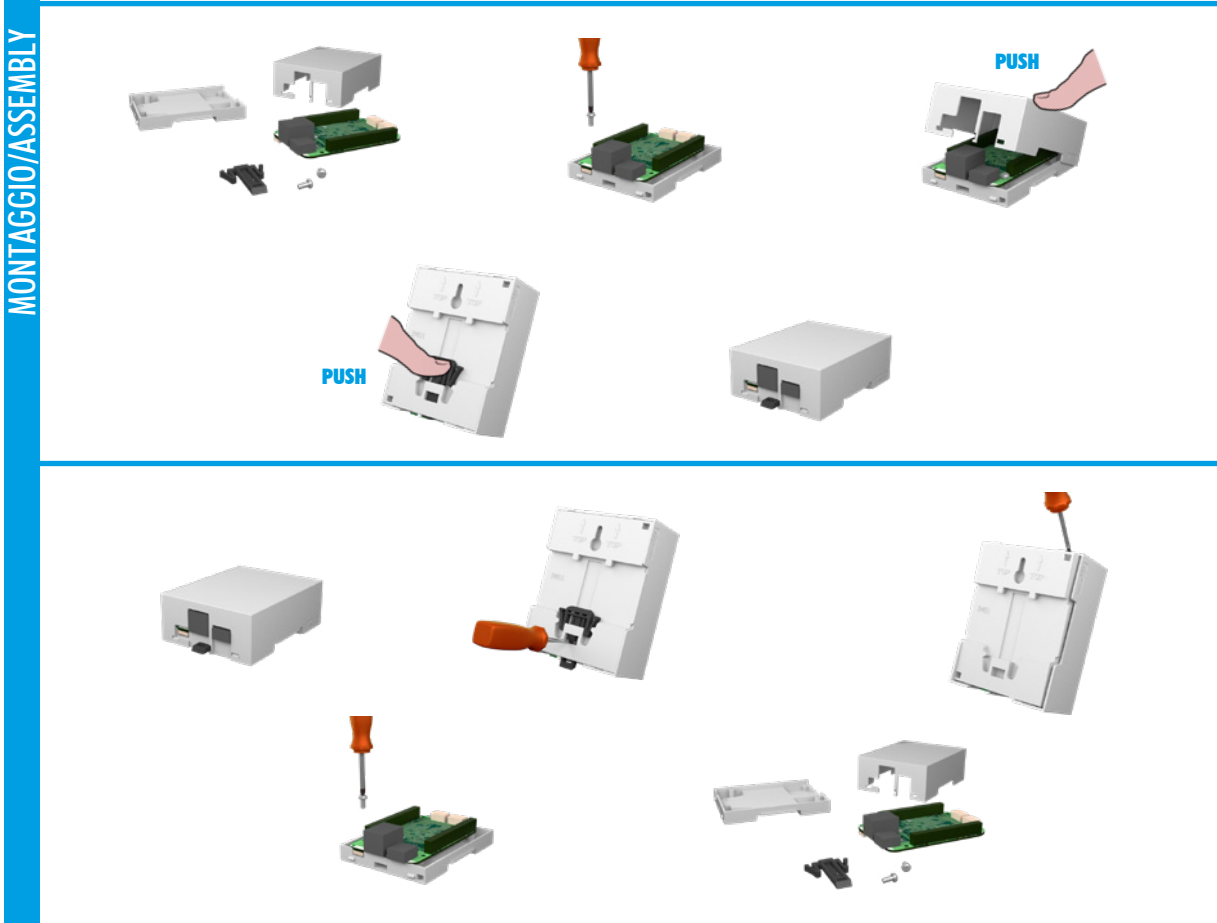

MONTAGGIO/ASSEMBLY

SMONTAGGIO/DISASSEMBLY

MONTAGGIO/ASSEMBLY

SMONTAGGIO/DISASSEMBLY

ASSEMBLAGGIO/DISASSEMBLAGGIO

ASSEMBLY/DISASSEMBLY

BEAGLEBONE GREEN WIRELESS

BEAGLEBONE GREEN WIRELESS

MONTAGGIO/ASSEMBLY

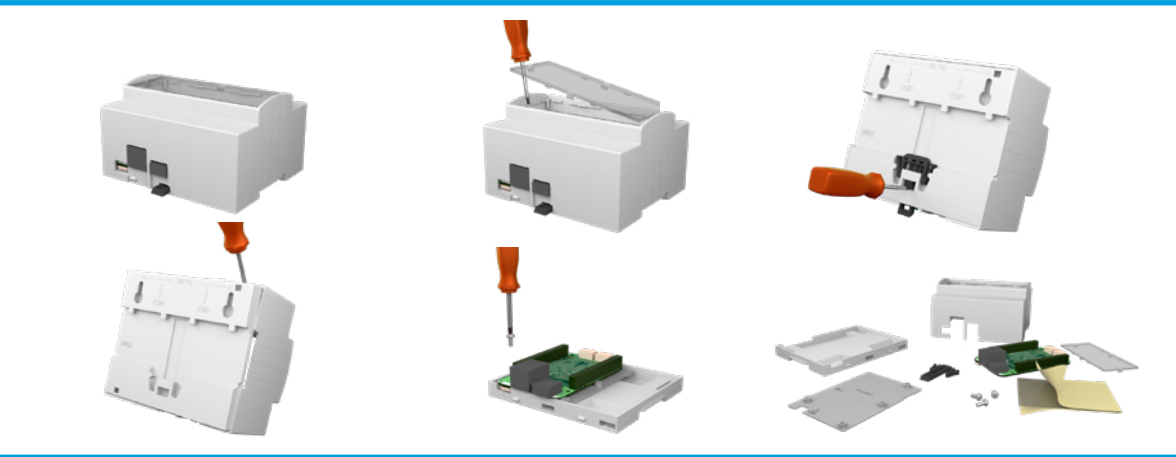
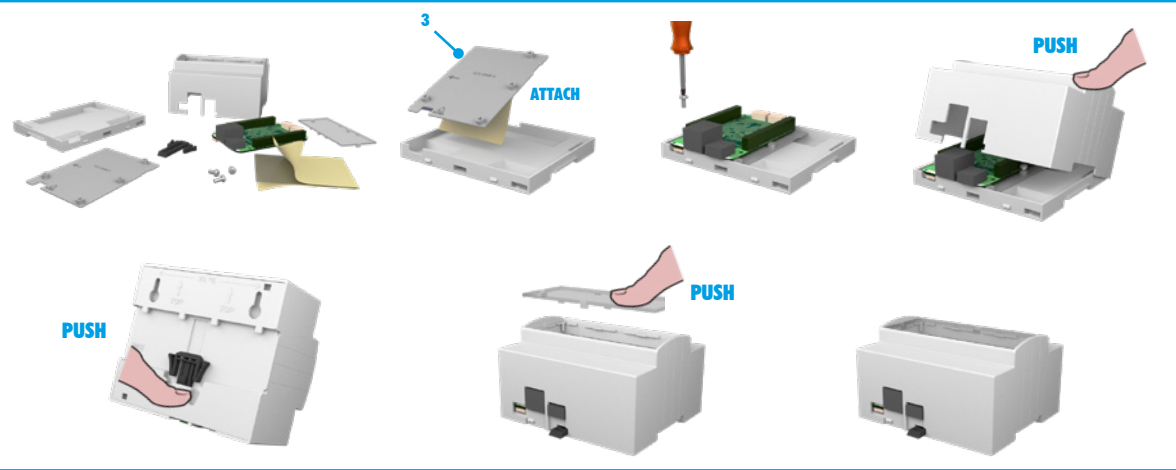

SMONTAGGIO/DISASSEMBLY

BEAGLEBONE GREEN WIRELESS compact

BEAGLEBONE GREEN WIRELESS compact

MONTAGGIO/ASSEMBLY

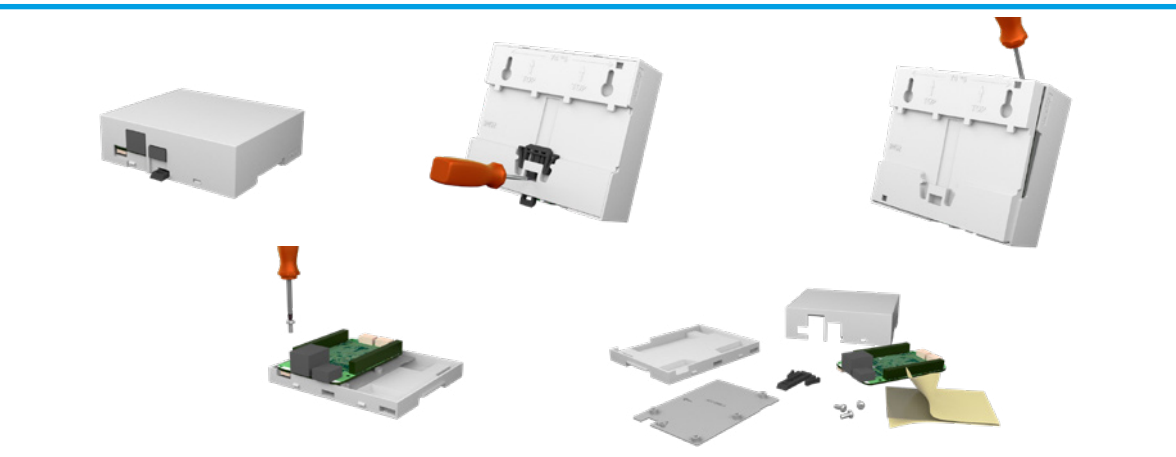
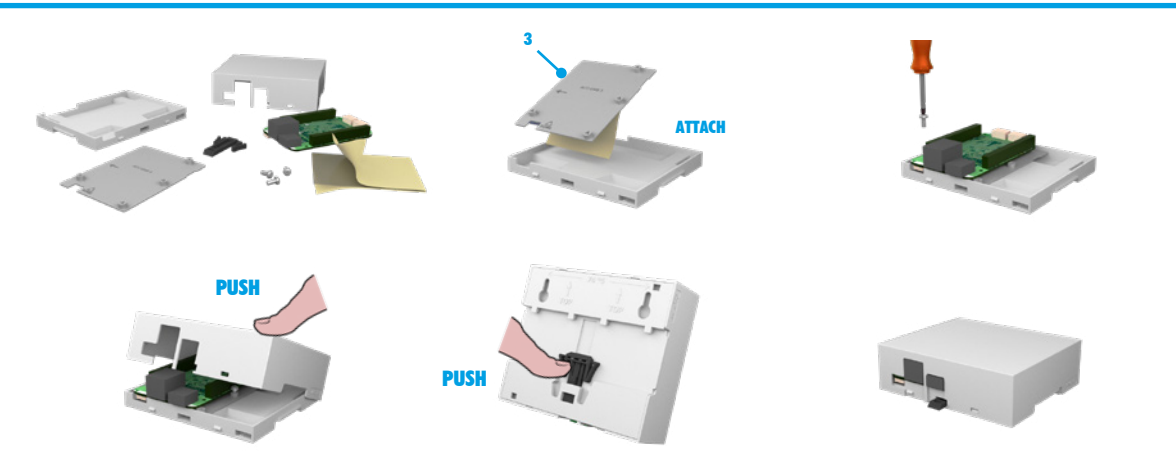

SMONTAGGIO/DISASSEMBLY

EMBEDDED BOX

RASPBERRY PI

RASPBERRY PI

MONTAGGIO/ASSEMBLY

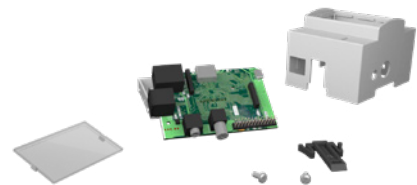
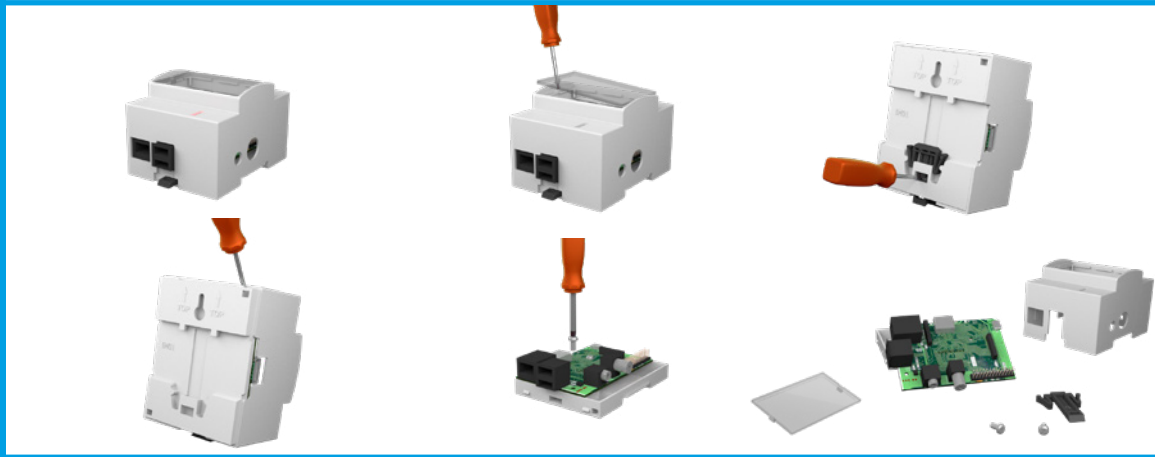
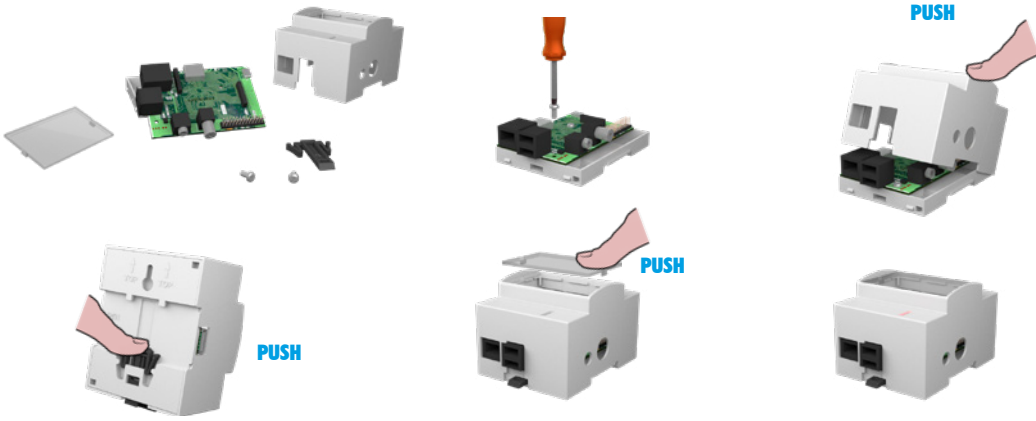

SMONTAGGIO/DISASSEMBLY



ASSEMBLAGGIO/DISASSEMBLAGGIO

ASSEMBLY/DISASSEMBLY

RASPBERRY PI B +

RASPBERRY PI B +

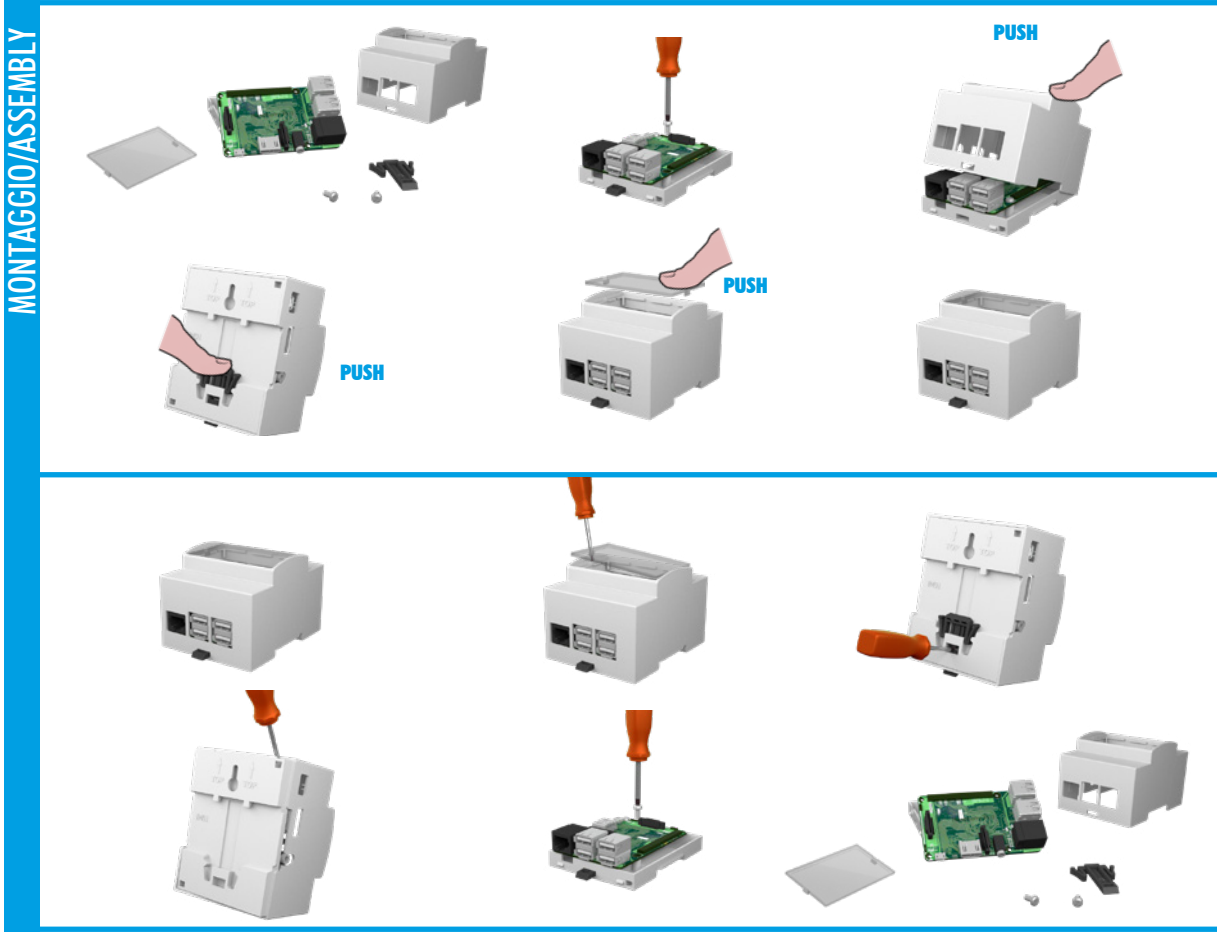

RASPBERRY PI B + compact

RASPBERRY PI B + compact

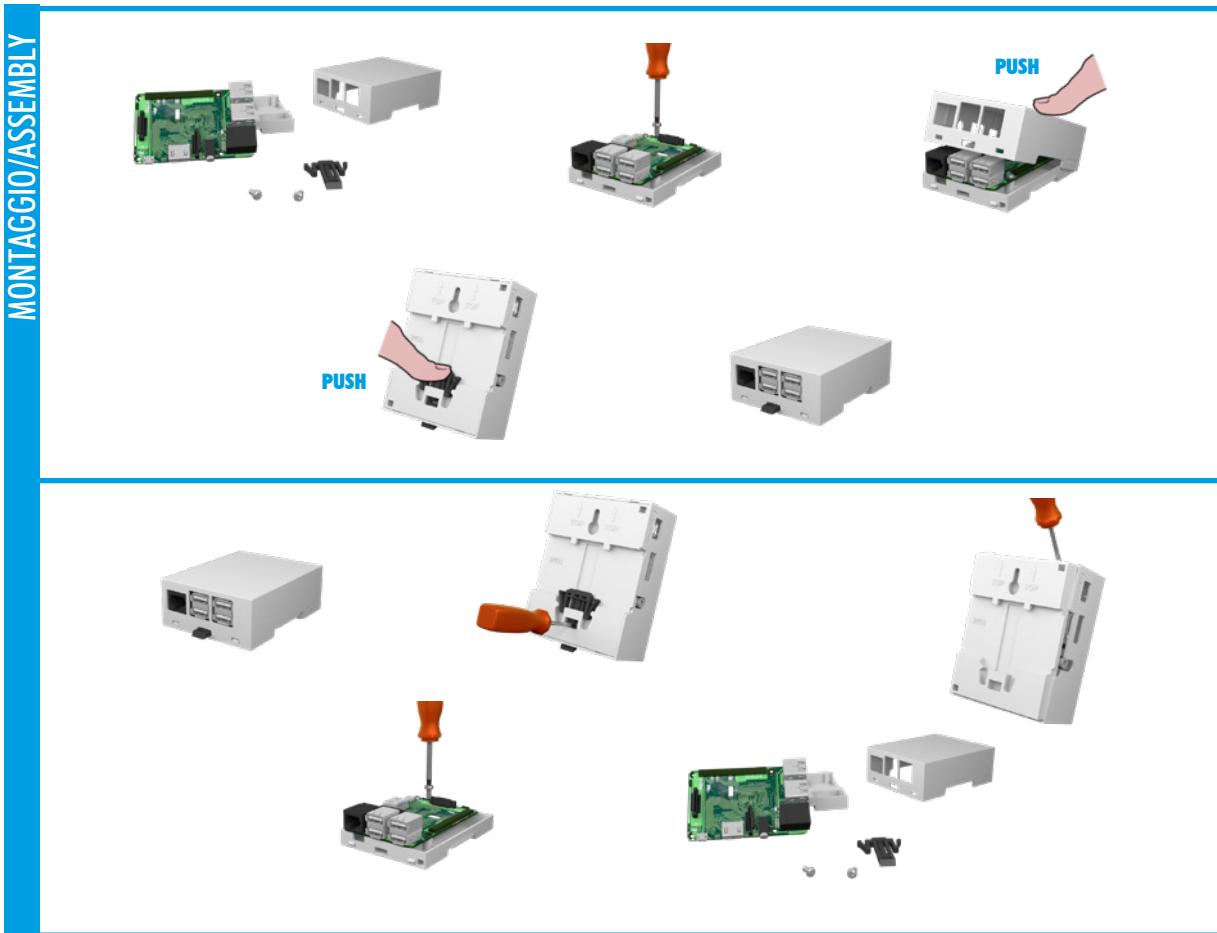



ASSEMBLAGGIO/DISASSEMBLAGGIO

ASSEMBLY/DISASSEMBLY

RASPERRY PI B +

RASPERRY PI B +

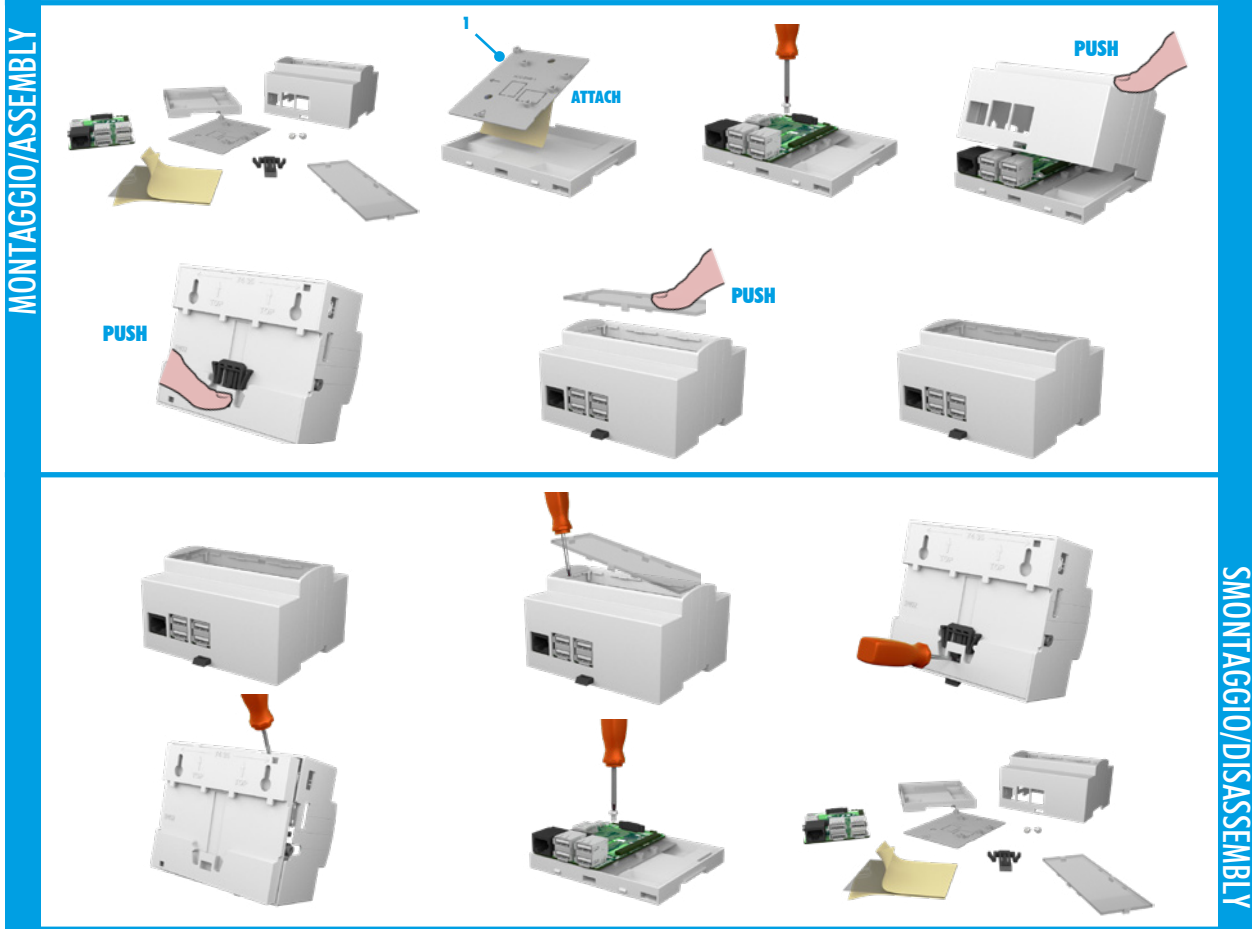

RASPERRY PI B + compact

RASPERRY PI B + compact

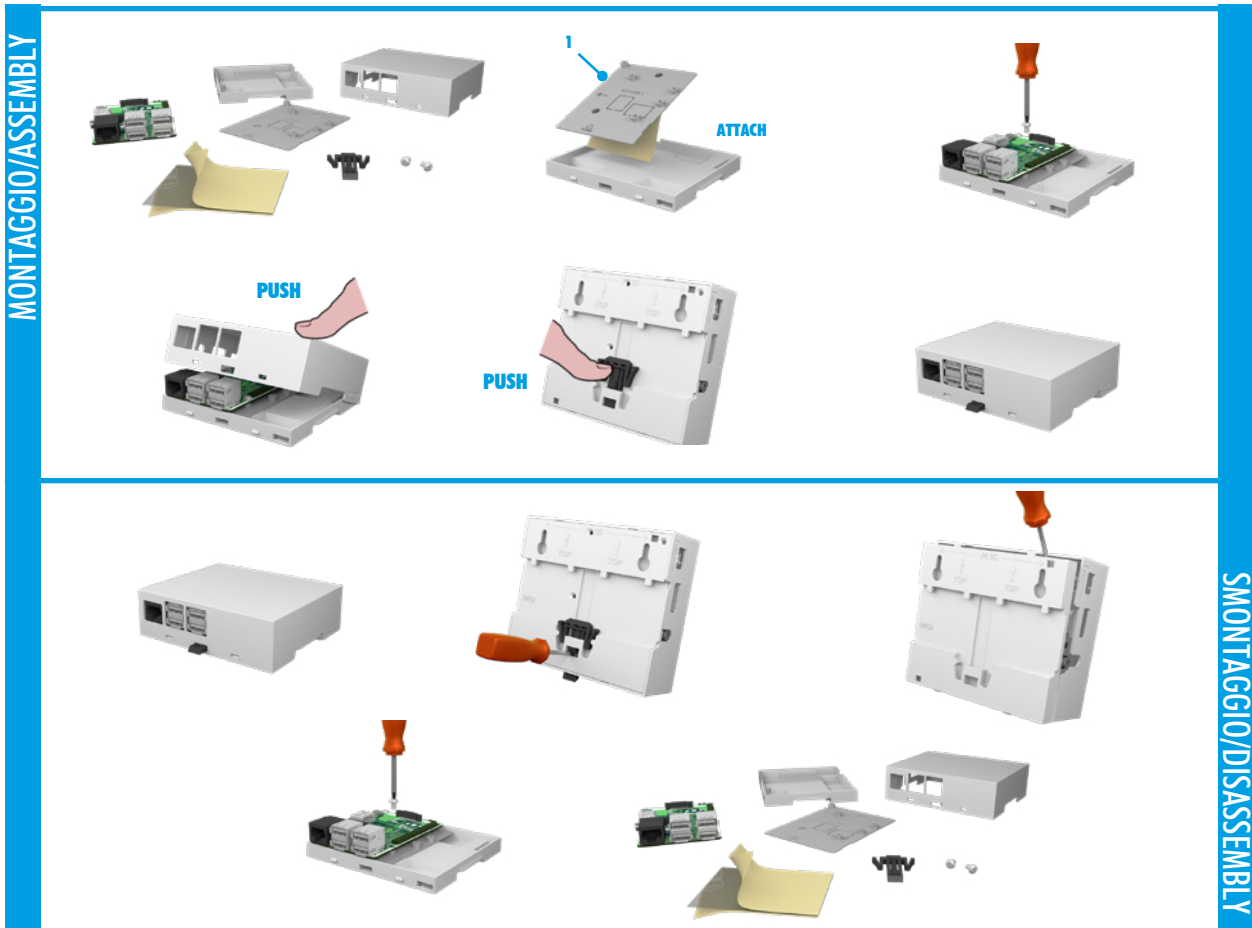



ASSEMBLAGGIO/DISASSEMBLAGGIO

RASPBERRY PI 3

MONTAGGIO/ASSEMBLY

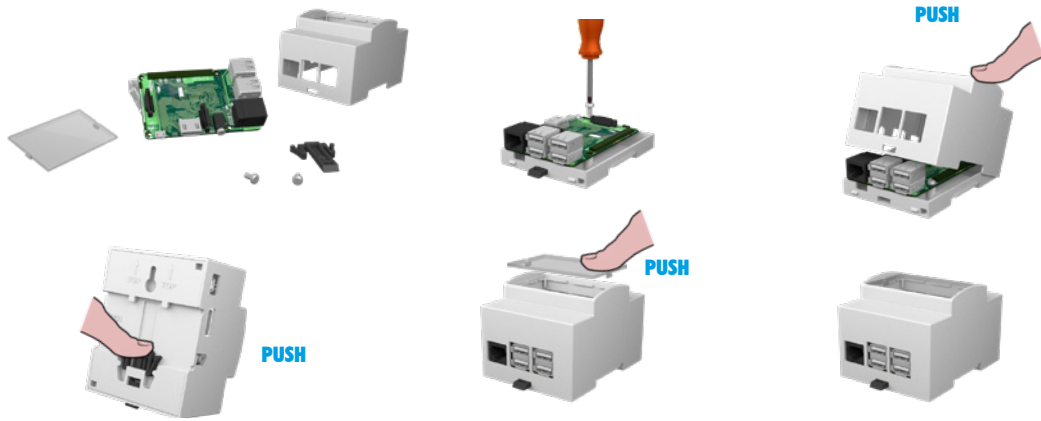

ASSEMBLY/DISASSEMBLY

RASPBERRY PI 3

SMONTAGGIO/DISASSEMBLY

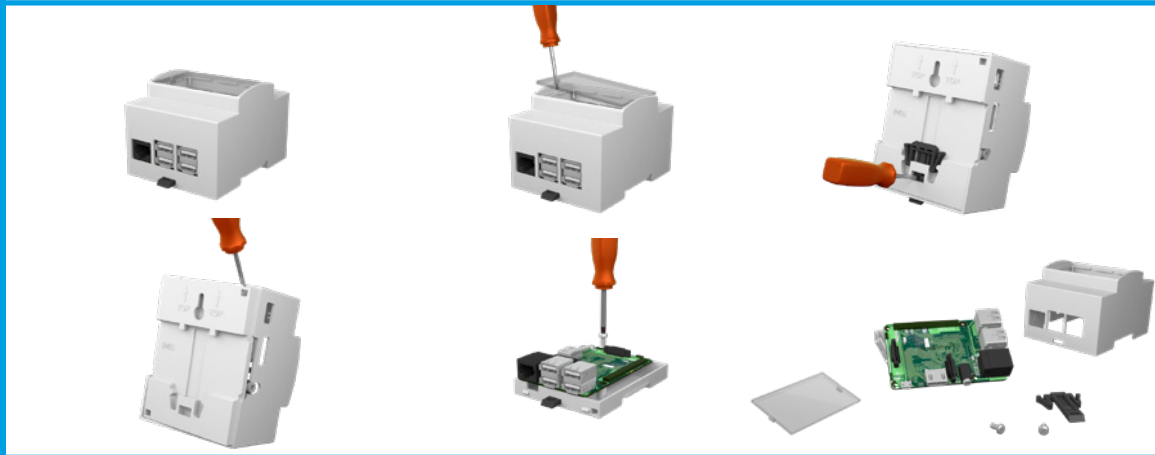

RASPBERRY PI 3 compact

MONTAGGIO/ASSEMBLY

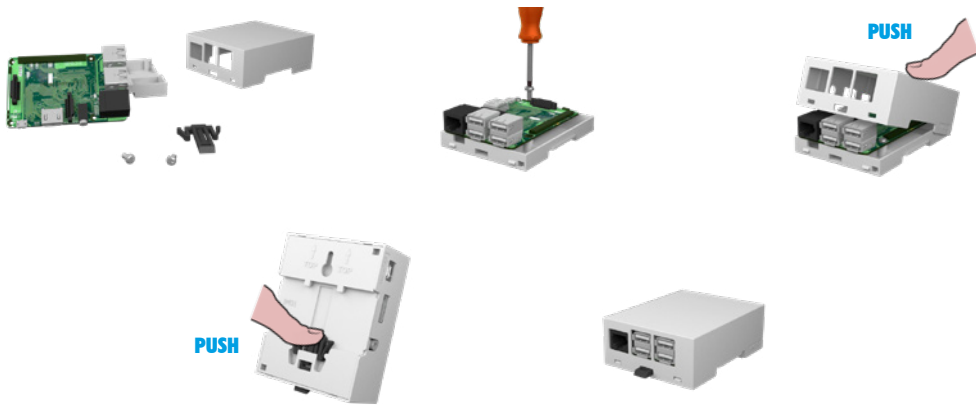

RASPBERRY PI 3 compact

SMONTAGGIO/DISASSEMBLY



EMBEDDED BOX

RASPBERRY PI 3

RASPBERRY PI 3

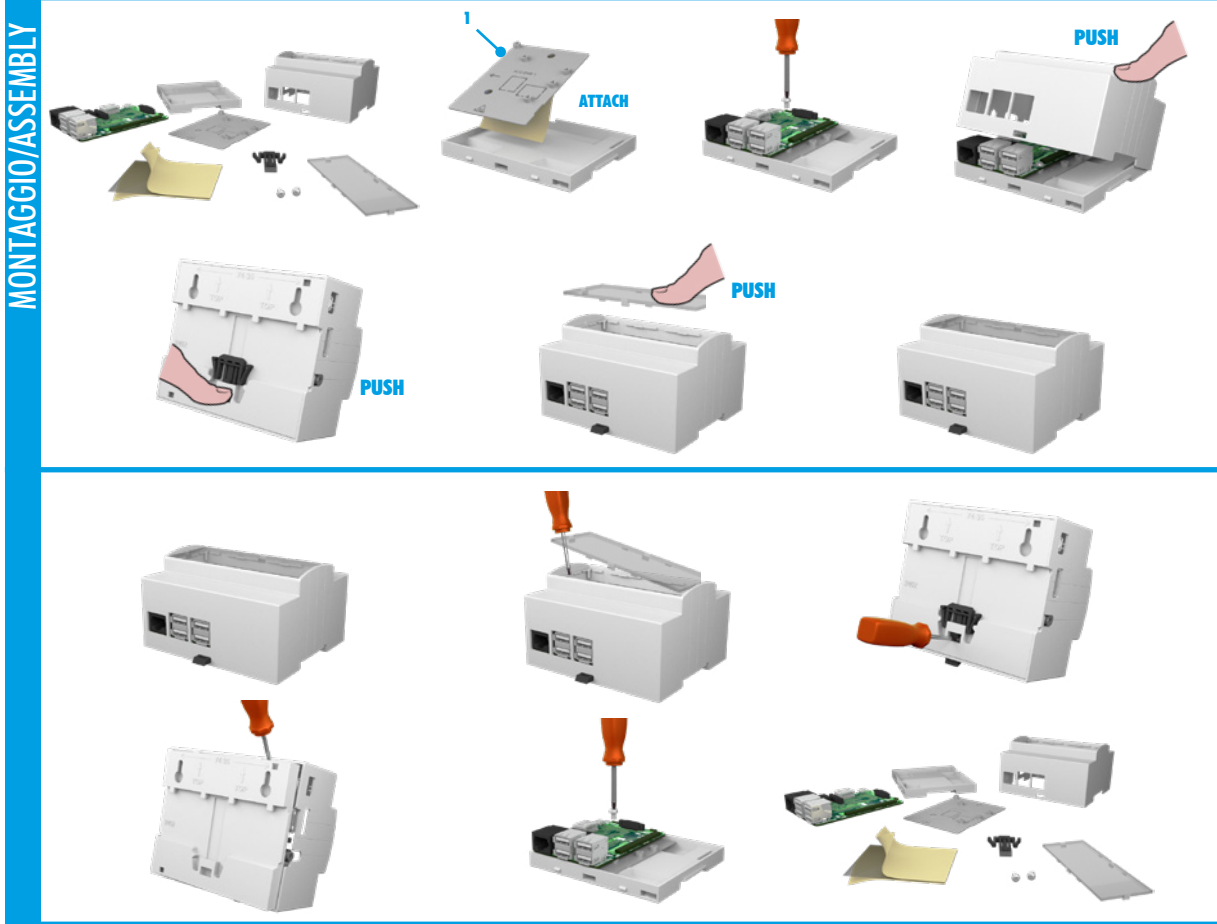

RASPBERRY PI 3 compact

RASPBERRY PI 3 compact

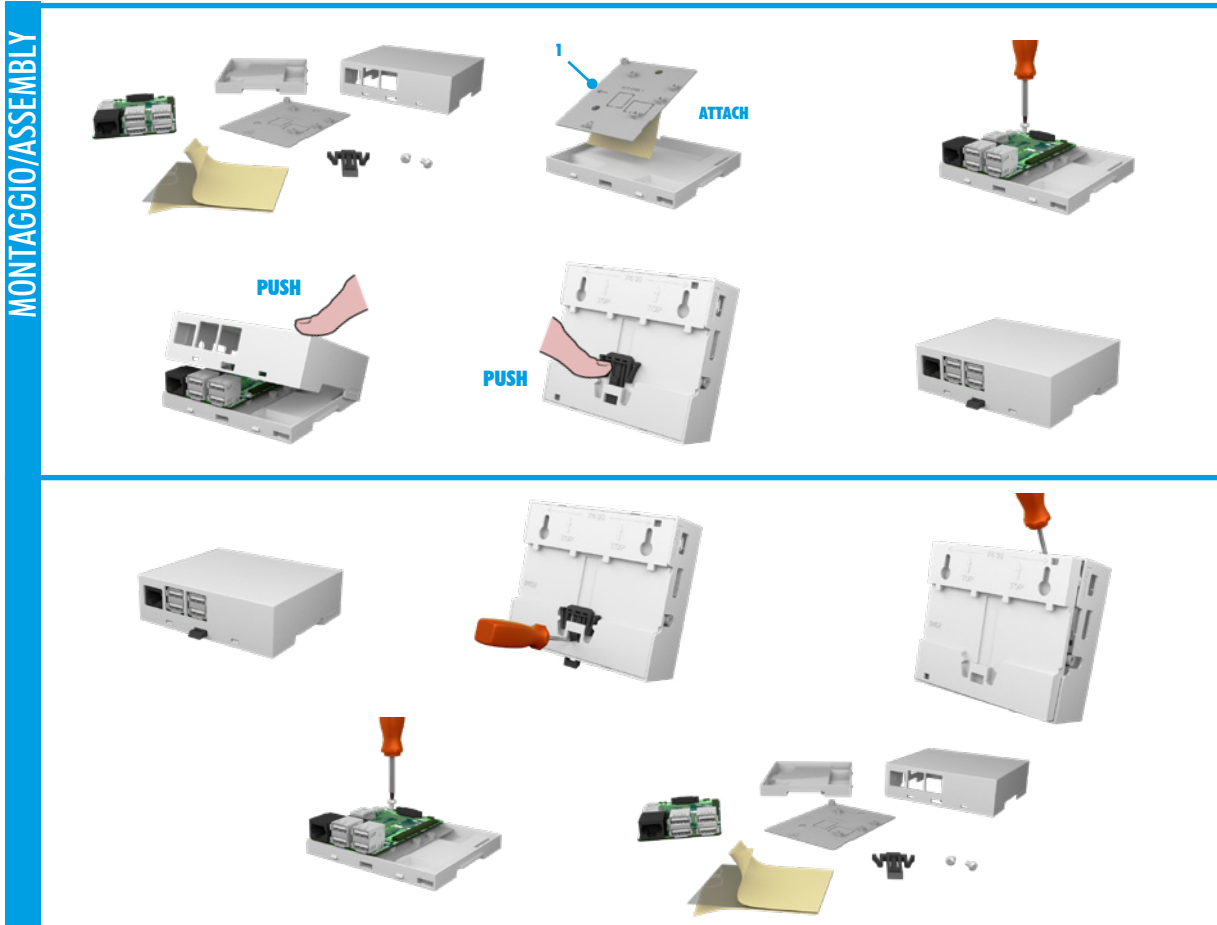

EMBEDDED BOX



MONTAGGIO/ASSEMBLY

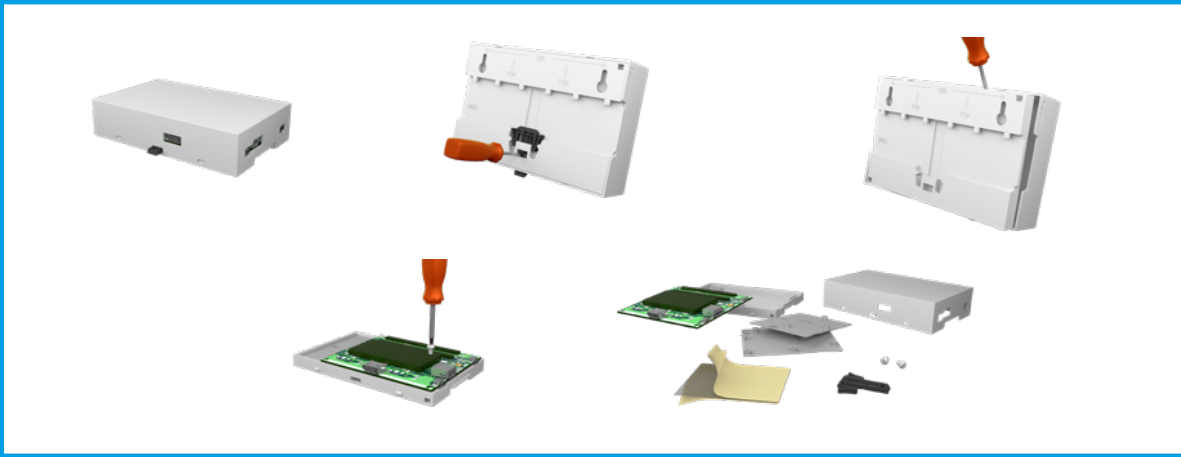
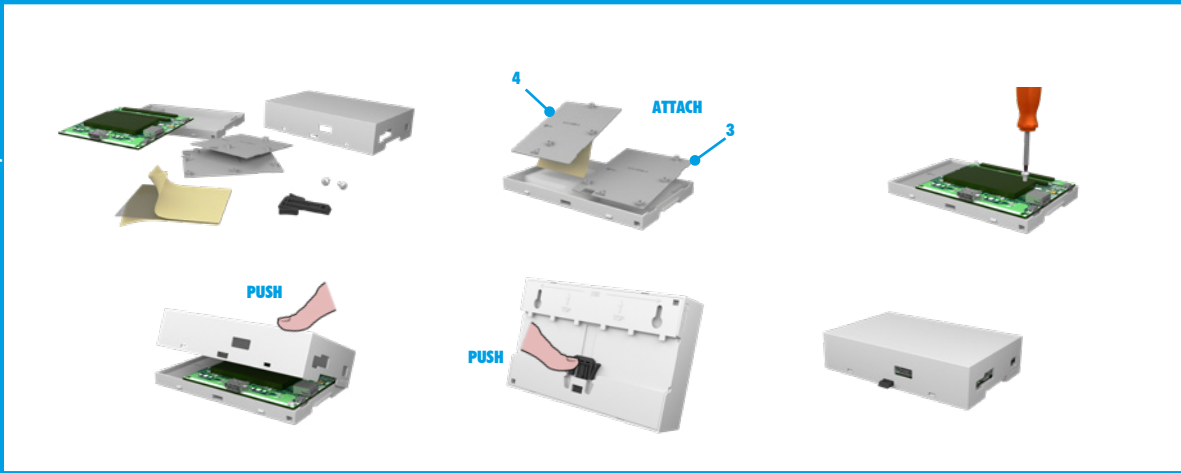

SMONTAGGIO/DISASSEMBLY



ASSEMBLAGGIO/DISASSEMBLAGGIO

ASSEMBLY/DISASSEMBLY

RASPBerry ZERO

RASPBerry ZERO

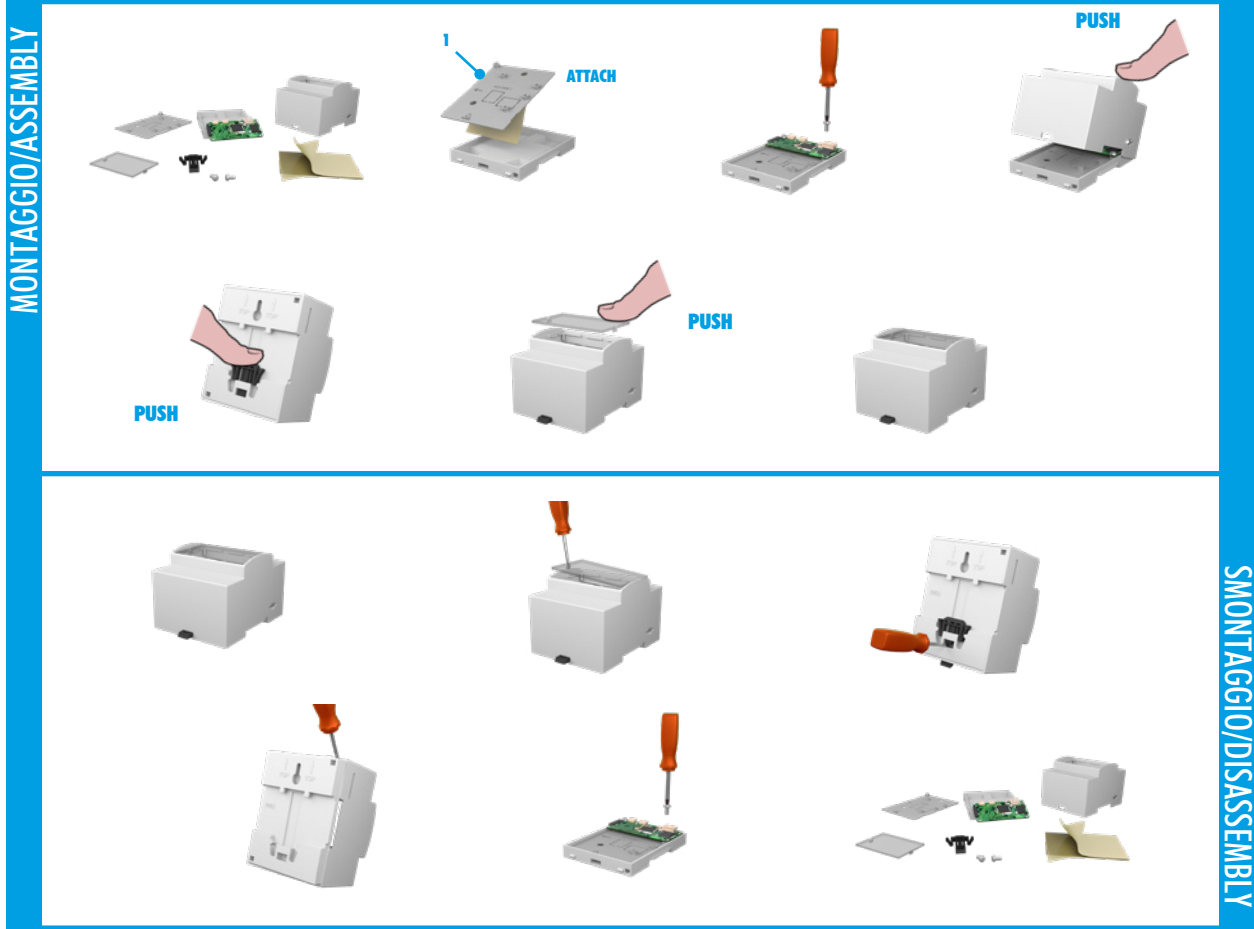

RASPBerry ZERO compact

RASPBerry ZERO compact

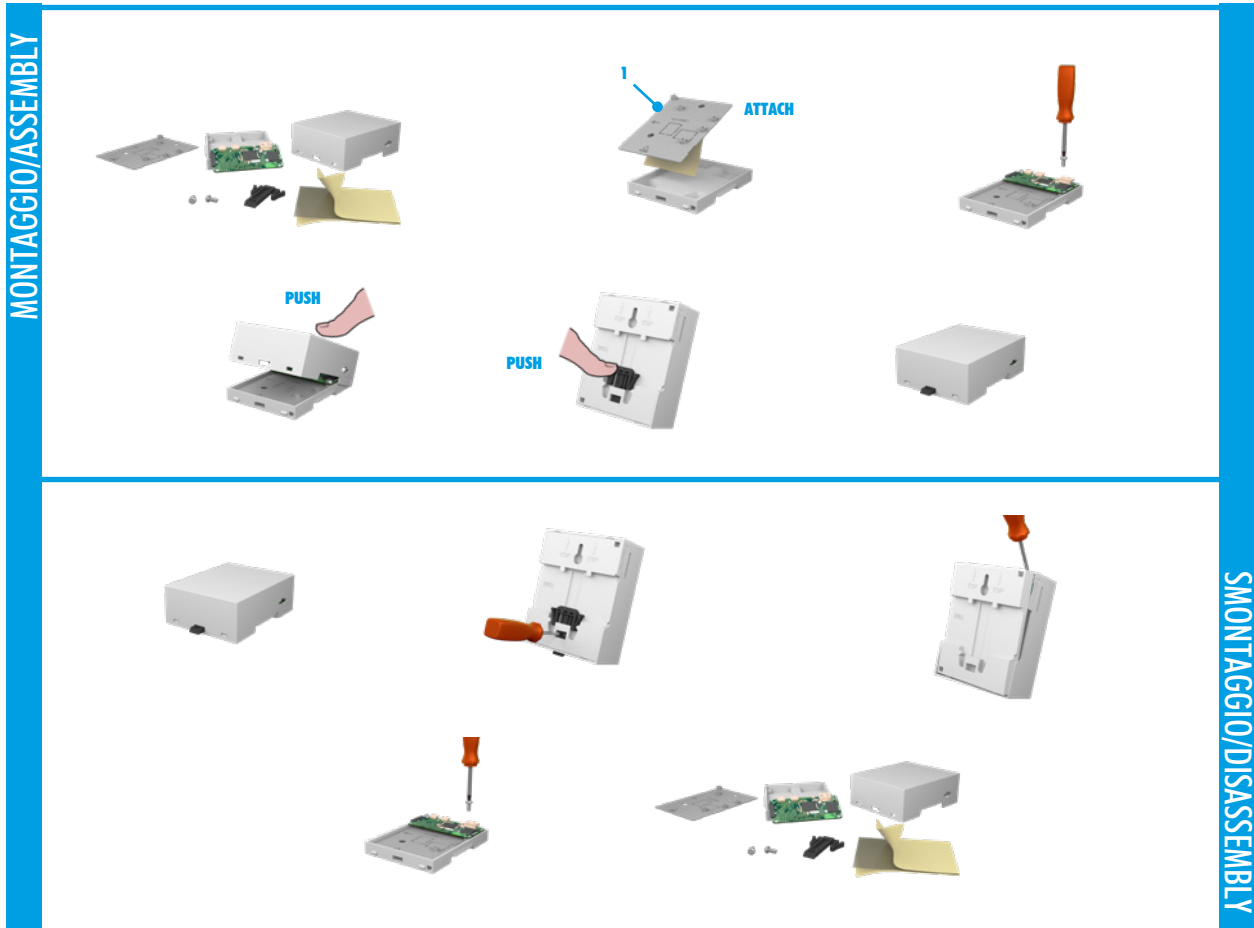



ASSEMBLAGGIO/DISASSEMBLAGGIO

ASSEMBLY/DISASSEMBLY

RASPBERRY PI 4

RASPBERRY PI 4

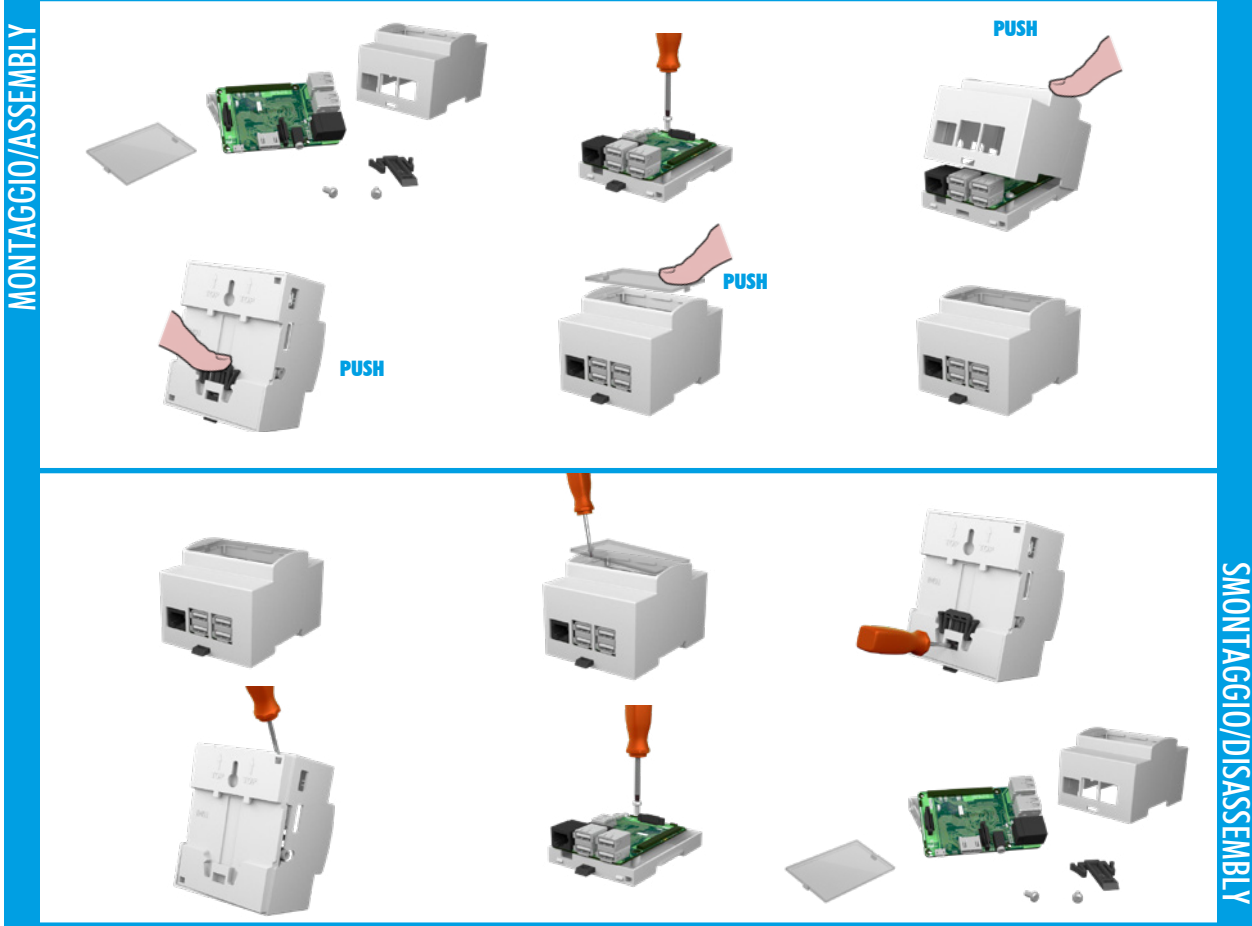

RASPBERRY PI 4 compact

RASPBERRY PI 4 compact

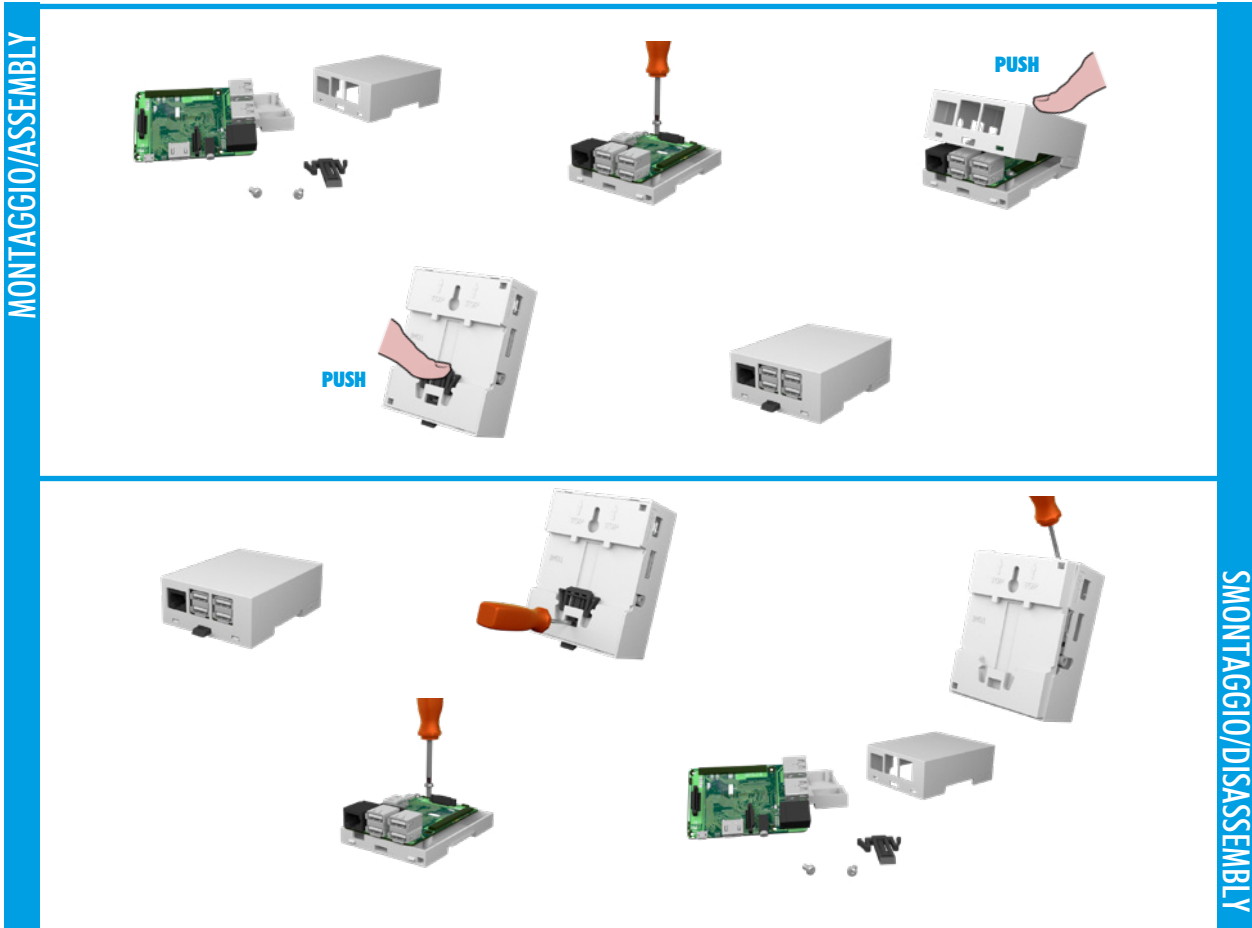



ASSEMBLAGGIO/DISASSEMBLAGGIO

ASSEMBLY/DISASSEMBLY

RASPBERRY PI 4

RASPBERRY PI 4

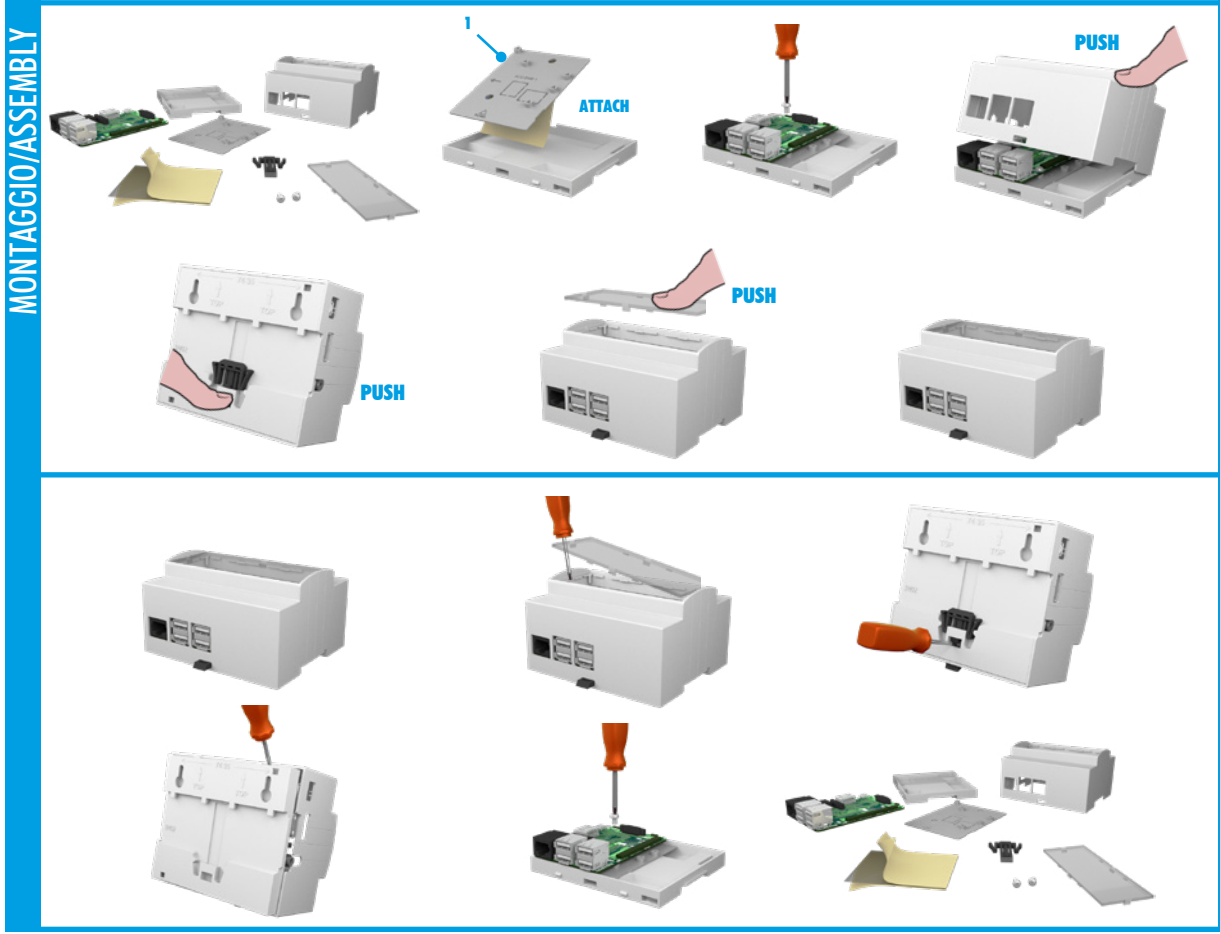

RASPBERRY PI 4 compact

RASPBERRY PI 4 compact

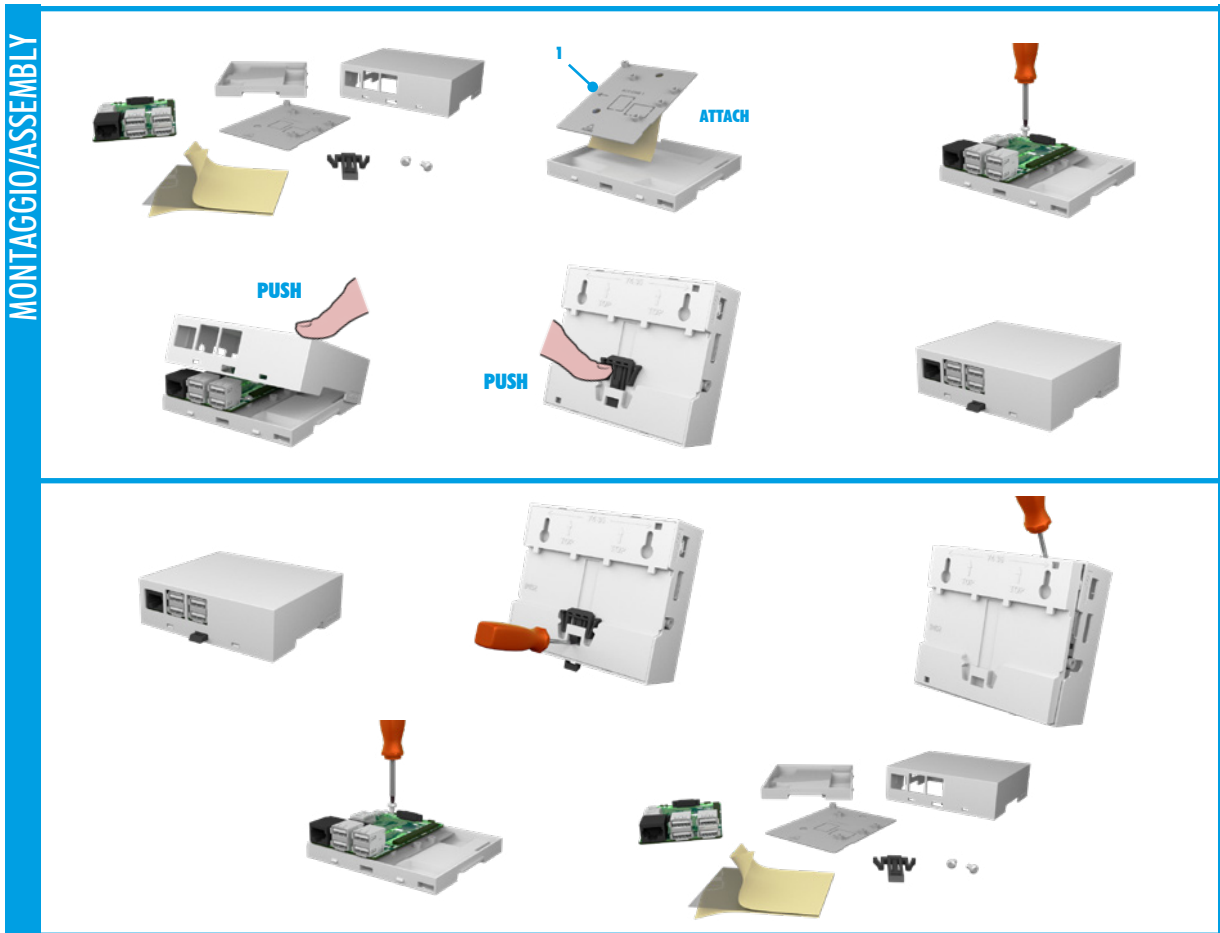

EMBEDDED BOX

RAILBOX RASPBERRY PI

RAILBOX RASPBERRY PI

MONTAGGIO/ASSEMBLY

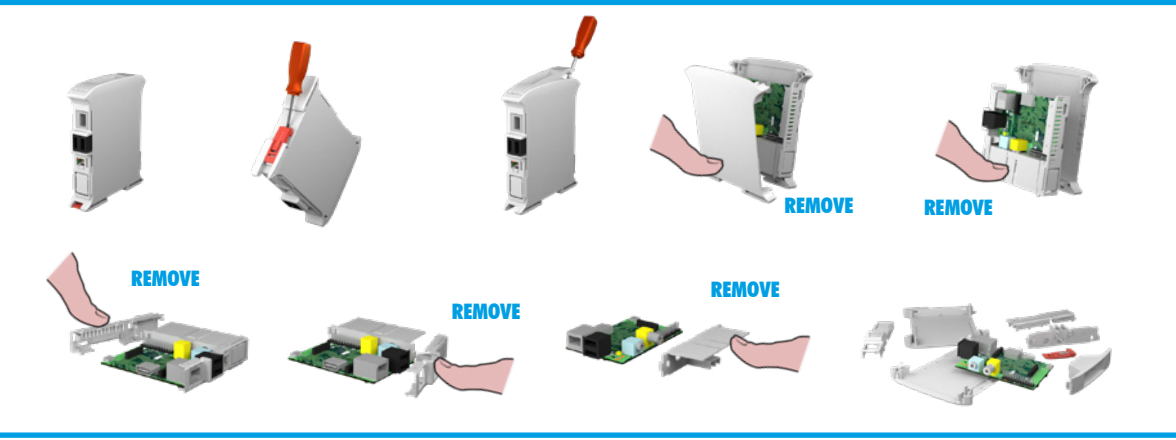
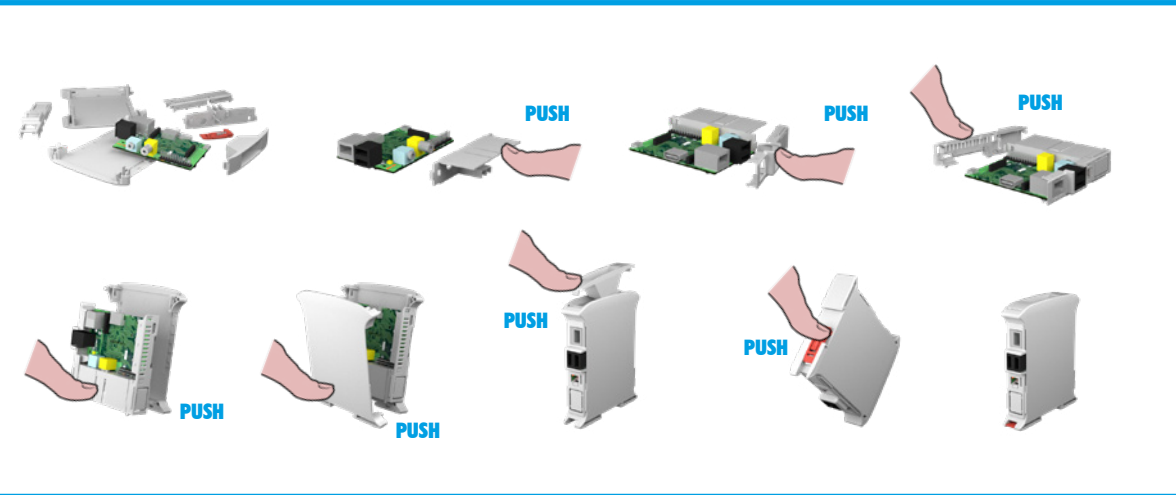

SMONTAGGIO/DISASSEMBLY



RAILBOX RASPBERRY PI B+ / PI 3 / P4

RAILBOX RASPBERRY PI B+ / PI 3 / P4

MONTAGGIO/ASSEMBLY

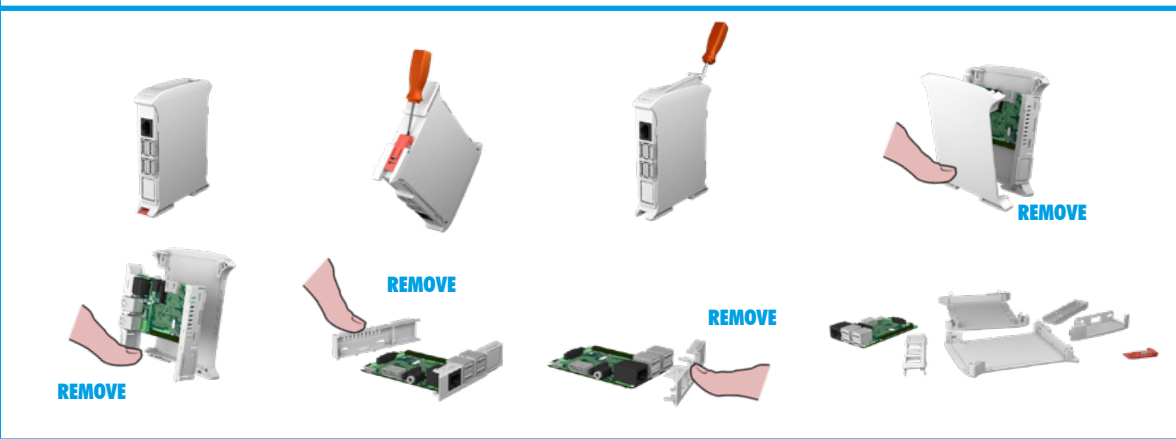
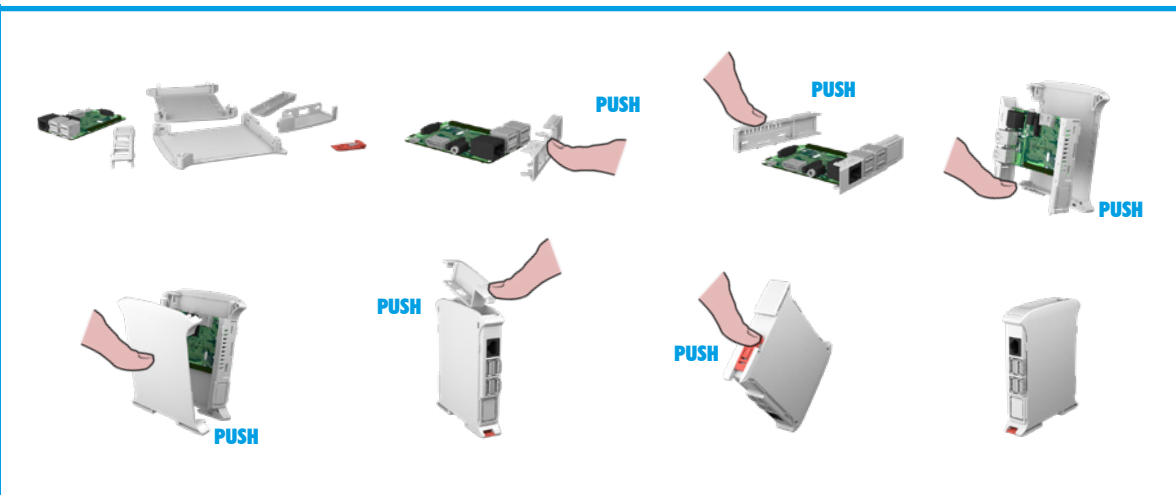

SMONTAGGIO/DISASSEMBLY



RASPBERRY PI B+ CARATTERISTICHE GENERALI

Contenitore per RASPBERRY PI B+ per applicazione industriale su guida DIN (EN 60715)

Materiale: PC/ABS autoestinguente UL94V-0
Colore: Grigio

CONTENITORE PER GUIDA DIN (EN 60715)

Italtronic propone una nuova linea di contenitori industriali e per HOME & BUILDING AUTOMATION adatti a contenere le più note schede elettroniche EMBEDDED.



RASPBERRY PI B+ GENERAL FEATURES

RASPBERRY PI B+ enclosure for rail din industrial (EN 60715) application.

Material: PC/ABS self-extinguishing UL94V-0
Colour: Grey

DIN RAIL (EN 60715) ENCLOSURE

Italtronic propose a new industrial and HOME & BUILDING AUTOMATION enclosures useful to contain the more famous EMBEDDED electronic boards.

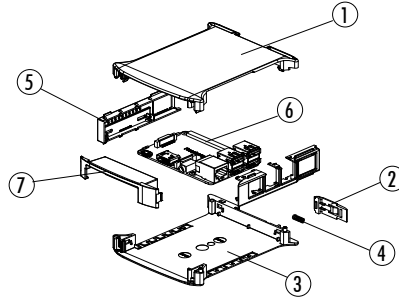

Descrizione/Description:

- 1) Coperchio/Cover
- 2) Gancio/Hook
- 3) Base/Base
- 4) Molla/Spring
- 5) Accessori laterali/Lateral accessories
- 6) Circuito stampato*/Pcb*
- 7) Pannello frontale/Front panel

* Non incluso / Not included

Contenitore Completo/Complete Enclosure

CODICE / CODE	COLORE / COLOUR	DESCRIZIONE/DESCRIPTION	FORMA/SHAPE
T0.0012225.RMB	Grigio/Grey	Kit 22,5 Raspberry PI B+ Railbox/22,5 Railbox Raspberry PI B+ kit	

Composizione Kit: il Kit comprende base, coperchio, gancio, molla, accessori laterali, pannello frontale

Kit composition: kit includes base, cover, hook, spring, lateral accessories, front panel.

DIMENSIONI B/B DIMENSIONS: 22,5 mm
DIMENSIONI L/L DIMENSIONS: 101 mm
DIMENSIONI H/H DIMENSIONS: 119,5 mm

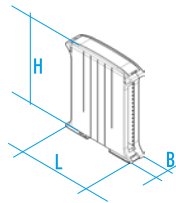

CONFEZIONE N° PCS/KIT: PACKAGING N° PCS/KIT:	50	PESO DELLA CONFEZIONE: PACKAGING WEIGHT:	4,5 kg	MINIMO ACQUISTABILE: MINIMUM ORDER:	1	PESO DEL PEZZO KIT: KIT WEIGHT:	70 g
--	-----------	--	---------------	---	----------	---	-------------

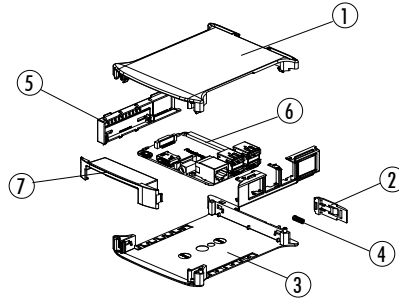

Descrizione/Description:

- 1) Coperchio/Cover
- 2) Gancio/Hook
- 3) Base/Base
- 4) Molla/Spring
- 5) Accessori laterali/Lateral accessories
- 6) Circuito stampato*/Pcb*
- 7) Pannello frontale/Front panel

* Non incluso / Not included

Contenitore Completo/Complete Enclosure

CODICE / CODE	COLORE / COLOUR	DESCRIZIONE/DESCRIPTION	FORMA/SHAPE
T0.0052450.RMB	Grigio/Grey	Kit 45 Raspberry PI B+ Railbox/45 Railbox Raspberry PI B+ kit	

Composizione Kit: il Kit comprende base, coperchio, gancio, molla, accessori laterali, pannello frontale

Kit composition: kit includes base, cover, hook, spring, lateral accessories, front panel.

DIMENSIONI B/B DIMENSIONS: 45 mm
DIMENSIONI L/L DIMENSIONS: 101 mm
DIMENSIONI H/H DIMENSIONS: 119,5 mm

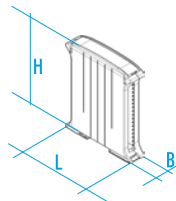

CONFEZIONE N° PCS/KIT: PACKAGING N° PCS/KIT:	50	PESO DELLA CONFEZIONE: PACKAGING WEIGHT:	5,75 kg	MINIMO ACQUISTABILE: MINIMUM ORDER:	1	PESO DEL PEZZO KIT: KIT WEIGHT:	95 g
--	-----------	--	----------------	---	----------	---	-------------





RASPERRY PI 4
CARATTERISTICHE GENERALI
Contenitore per RASPERRY PI 4 per applicazio-
ne industriale su guida DIN (EN 60715)



Materiale: PC/ABS autoestinguente UL94V-0
Colore: Grigio

CONTENITORE PER GUIDA DIN (EN 60715)
 Italtronic propone una nuova linea di contenitori industriali e per HOME & BUILDING AUTOMATION adatti a contenere le più note schede elettroniche EMBEDDED.



RASPERRY PI 4
GENERAL FEATURES
RASPERRY PI 4 enclosure for rail din industrial
(EN 60715) application.



Material: PC/ABS self-extinguishing UL94V-0
Colour: Grey

DIN RAIL (EN 60715) ENCLOSURE
 Italtronic propose a new industrial and HOME & BUILDING AUTOMATION enclosures useful to contain the more famous EMBEDDED electronic boards.

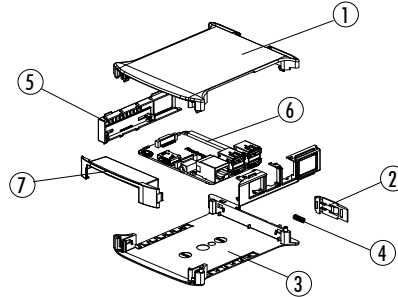

- Descrizione/Description:**
- 1) Coperchio/Cover
 - 2) Gancio/Hook
 - 3) Base/Base
 - 4) Molla/Spring
 - 5) Accessori laterali/Lateral accessories
 - 6) Circuito stampato*/Pcb*
 - 7) Pannello frontale/Front panel
- * Non incluso / Not included

Contenitore Completo/Complete Enclosure

CODICE / CODE	COLORE / COLOUR	DESCRIZIONE/DESCRIPTION	FORMA/SHAPE
10.0012225.RP4	Grigio/Grey	Kit 22,5 Railbox Raspberry PI 4/22,5 Railbox Raspberry PI 4 kit	

Composizione Kit: il Kit comprende base, coperchio, gancio, molla, accessori laterali, pannello frontale

Kit composition: kit includes base, cover, hook, spring, lateral accessories, front panel.

DIMENSIONI B/B DIMENSIONS: 22,5 mm
DIMENSIONI L/L DIMENSIONS: 101 mm
DIMENSIONI H/H DIMENSIONS: 119,5 mm

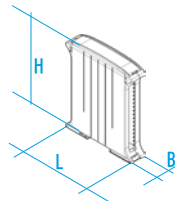

CONFEZIONE N° PCS/KIT: PACKAGING N° PCS/KIT:	50	PESO DELLA CONFEZIONE: PACKAGING WEIGHT:	4,5 kg	MINIMO ACQUISTABILE: MINIMUM ORDER:	1	PESO DEL PEZZO KIT: KIT WEIGHT:	70 g
---	-----------	---	---------------	--	----------	--	-------------

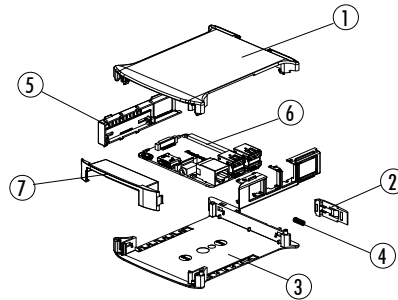

- Descrizione/Description:**
- 1) Coperchio/Cover
 - 2) Gancio/Hook
 - 3) Base/Base
 - 4) Molla/Spring
 - 5) Accessori laterali/Lateral accessories
 - 6) Circuito stampato*/Pcb*
 - 7) Pannello frontale/Front panel
- * Non incluso / Not included

Contenitore Completo/Complete Enclosure

CODICE / CODE	COLORE / COLOUR	DESCRIZIONE/DESCRIPTION	FORMA/SHAPE
10.0052450.RP4	Grigio/Grey	Kit 45 Railbox Raspberry PI 4/45 Railbox Raspberry PI 4 kit	

Composizione Kit: il Kit comprende base, coperchio, gancio, molla, accessori laterali, pannello frontale

Kit composition: kit includes base, cover, hook, spring, lateral accessories, front panel.

DIMENSIONI B/B DIMENSIONS: 45 mm
DIMENSIONI L/L DIMENSIONS: 101 mm
DIMENSIONI H/H DIMENSIONS: 119,5 mm

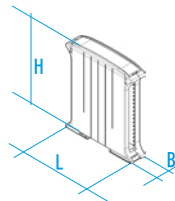

CONFEZIONE N° PCS/KIT: PACKAGING N° PCS/KIT:	50	PESO DELLA CONFEZIONE: PACKAGING WEIGHT:	5,75 kg	MINIMO ACQUISTABILE: MINIMUM ORDER:	1	PESO DEL PEZZO KIT: KIT WEIGHT:	95 g
---	-----------	---	----------------	--	----------	--	-------------



ODROID C1**CARATTERISTICHE GENERALI****Contenitore per ODROID C1 per guida DIN (EN 60715)****Materiale:** PC/ABS autoestinguente UL94V-0**Colore:** Grigio**CONTENITORE PER GUIDA DIN (EN 60715)**

Italtronic propone una nuova linea di contenitori industriali e per HOME & BUILDING AUTOMATION adatti a contenere le più note schede elettroniche EMBEDDED.

**ODROID C1****GENERAL FEATURES****Enclosure ODROID C1 for rail din (EN 60715) application.****Material:** PC/ABS self-extinguishing UL94V-0**Colour:** Grey**DIN RAIL (EN 60715) ENCLOSURE**

Italtronic propose a new industrial and HOME & BUILDING AUTOMATION enclosures useful to contain the more famous EMBEDDED electronic boards.

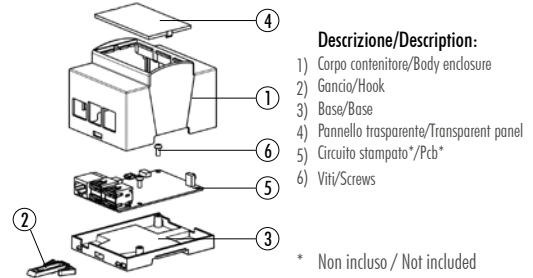
**Contenitore Completo/Complete Enclosure**

CODICE / CODE	COLORE / COLOUR	DESCRIZIONE/DESCRIPTION	FORMA/SHAPE
25.0410000.OC1	Grigio/Grey	Kit 4M XTS Odroid C1/4M XTS Odroid C1 kit	C/C

Composizione Kit: il Kit comprende corpo, base, gancio, pannello trasparente, 2 viti

Kit composition: kit includes body enclosure, base, hook, transparent panel, 2 screws.

DIMENSIONI B/B DIMENSIONS: 90 mm

DIMENSIONI L/L DIMENSIONS: 71 mm

DIMENSIONI H/H DIMENSIONS: 55 mm

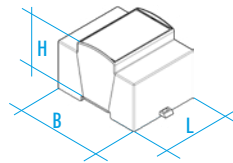

CONFEZIONE N° PCS/KIT: 50
PACKAGING N° PCS/KIT: 50

PESO DELLA CONFEZIONE: 4,5 kg
PACKAGING WEIGHT: 4,5 kg

MINIMO ACQUISTABILE: 1
MINIMUM ORDER: 1

PESO DEL PEZZO KIT: 70 g
KIT WEIGHT: 70 g

TIPO GUIDA DIN/DIN RAIL TYPE: Norme EN 60715/EN 60715 NORM

NORMA CONTENITORE/ENCLOSURE STANDARD: Norme DIN 43880/43880 DIN NORM



ODROID C1 + CARATTERISTICHE GENERALI

Contenitore per ODROID C1+ per guida DIN (EN 60715)

Materiale: PC/ABS autoestinguente UL94V-0
Colore: Grigio

CONTENITORE PER GUIDA DIN (EN 60715)

Italtronic propone una nuova linea di contenitori industriali e per HOME & BUILDING AUTOMATION adatti a contenere le più note schede elettroniche EMBEDDED.



ODROID C1 + GENERAL FEATURES

Enclosure ODROID C1+ for rail DIN (EN 60715) application

Material: PC/ABS self-extinguishing UL94V-0
Colour: Grey

DIN RAIL (EN 60715) ENCLOSURE

Italtronic propose a new industrial and HOME & BUILDING AUTOMATION enclosures useful to contain the more famous EMBEDDED electronic boards.

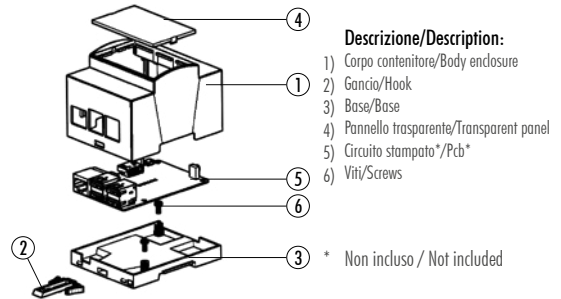

Contenitore Completo/Complete Enclosure

CODICE / CODE	COLORE / COLOUR	DESCRIZIONE/DESCRIPTION	FORMA/SHAPE
25.0410000.OCP	Grigio/Grey	Kit 4M XTS Odroid C1 +/4M XTS Odroid C1 + kit	C/C

Composizione Kit: il Kit comprende corpo, base, gancio, pannello trasp., 2 viti

Kit composition: kit includes body enclosure, base, hook, transparent panel, 2 screws

DIMENSIONI B/B DIMENSIONS: 90 mm
DIMENSIONI L/L DIMENSIONS: 71 mm
DIMENSIONI H/H DIMENSIONS: 55 mm

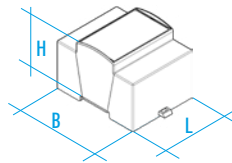

CONFEZIONE N° PCS/KIT: 50
PACKAGING N° PCS/KIT:

PESO DELLA CONFEZIONE: 4,5 kg
PACKAGING WEIGHT:

MINIMO ACQUISTABILE: 1
MINIMUM ORDER:

PESO DEL PEZZO KIT: 70 g
KIT WEIGHT:

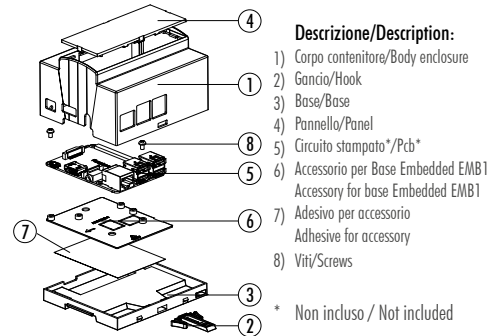

Contenitore Completo/Complete Enclosure

CODICE / CODE	COLORE / COLOUR	DESCRIZIONE/DESCRIPTION	FORMA/SHAPE
25.0610000.OCP	Grigio/Grey	Kit 6M XTS Odroid C1 +/6M XTS Odroid C1 + kit	C/C

Composizione Kit: il Kit comprende corpo, base, gancio, pannello trasp., accessorio base embedded, adesivo, 3 viti.

Kit composition: kit includes body enclosure, base, hook, transparent panel, accessory for base embedded, adhesive for accessory, 3 screws.

DIMENSIONI B/B DIMENSIONS: 90 mm
DIMENSIONI L/L DIMENSIONS: 106,5 mm
DIMENSIONI H/H DIMENSIONS: 55 mm

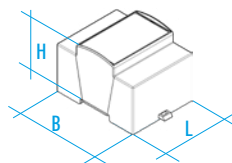

CONFEZIONE N° PCS/KIT: 25
PACKAGING N° PCS/KIT:

PESO DELLA CONFEZIONE: 3,25 kg
PACKAGING WEIGHT:

MINIMO ACQUISTABILE: 1
MINIMUM ORDER:

PESO DEL PEZZO KIT: 90 g
KIT WEIGHT:

TIPO GUIDA DIN/DIN RAIL TYPE: Norme EN 60715/EN 60715 NORM
NORMA CONTENITORE/ENCLOSURE STANDARD: Norme DIN 43880/43880 DIN NORM



EMB 3

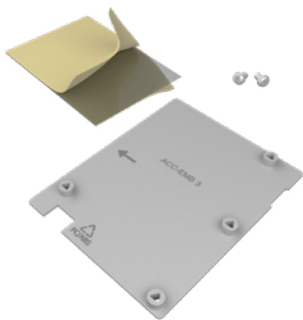

Contenitore Completo/Complete Enclosure

CODICE / CODE DESCRIZIONE/DESCRIPTION

CODICE / CODE	DESCRIZIONE/DESCRIPTION
25.000EMB3	Kit accessorio per base embedded EMB 3/Accessory for Embedded base EMB 3

Composizione Kit: L'accessorio può accogliere le schede Embedded: Beaglebone Black e Beaglebone Green.

Kit composition: The accessory can accommodate Embedded boards: Beaglebone Black e Beaglebone Green.

CONFEZIONE N° PCS/KIT: 25
PACKAGING N° PCS/KIT:

PESO DELLA CONFEZIONE: 0,6 kg
PACKAGING WEIGHT:

MINIMO ACQUISTABILE: 1
MINIMUM ORDER:

PESO DEL PEZZO KIT: 20 g
KIT WEIGHT:

EMB 4

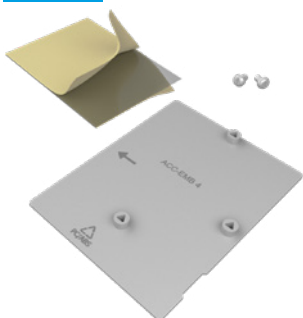

Contenitore Completo/Complete Enclosure

CODICE / CODE DESCRIZIONE/DESCRIPTION

CODICE / CODE	DESCRIZIONE/DESCRIPTION
25.000EMB4	Kit accessorio per base embedded EMB 4/Accessory for Embedded base EMB 4

CONFEZIONE N° PCS/KIT: 25
PACKAGING N° PCS/KIT:

PESO DELLA CONFEZIONE: 0,6 kg
PACKAGING WEIGHT:

MINIMO ACQUISTABILE: 1
MINIMUM ORDER:

PESO DEL PEZZO KIT: 20 g
KIT WEIGHT:

COME QUOTARE E CONTROLLARE LE MISURE DELLE LAVORAZIONI

Qui sotto riportiamo un esempio di come possono essere eseguite delle misure affinché risultino centrate con altri processi, come quello di STAMPA, e siano ortogonali ai piani di riferimento dei nostri prodotti.

HOW TO QUOTE AND TO CHECK THE MACHINING DIMENSIONS

Below is an example of how the measurements can be taken so that they are centred with other processes, such as PRINT, and are at right angles to the reference surfaces of our products.

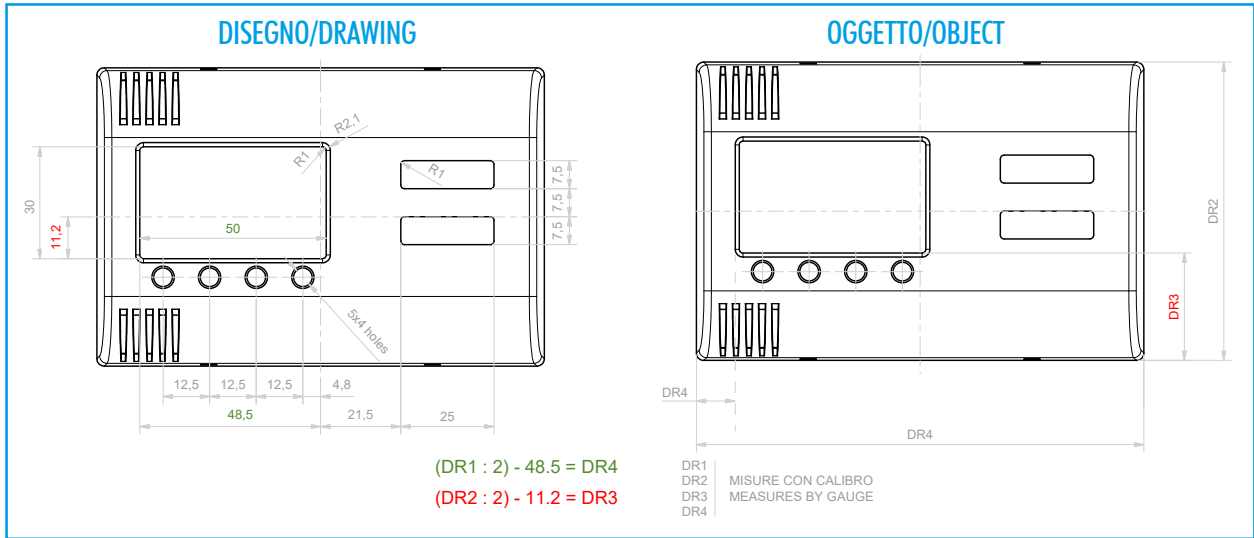

SVASATURE E RIBASSI

ITALTRONIC offre un ottimo servizio di finitura meccanica adatta a migliorare l'estetica del prodotto, con svasature e ribassi.

FLARING & LOWERING

ITALTRONIC offers a very good mechanical Finishing Service for a better aesthetics result of the products, with flaring and lowering.

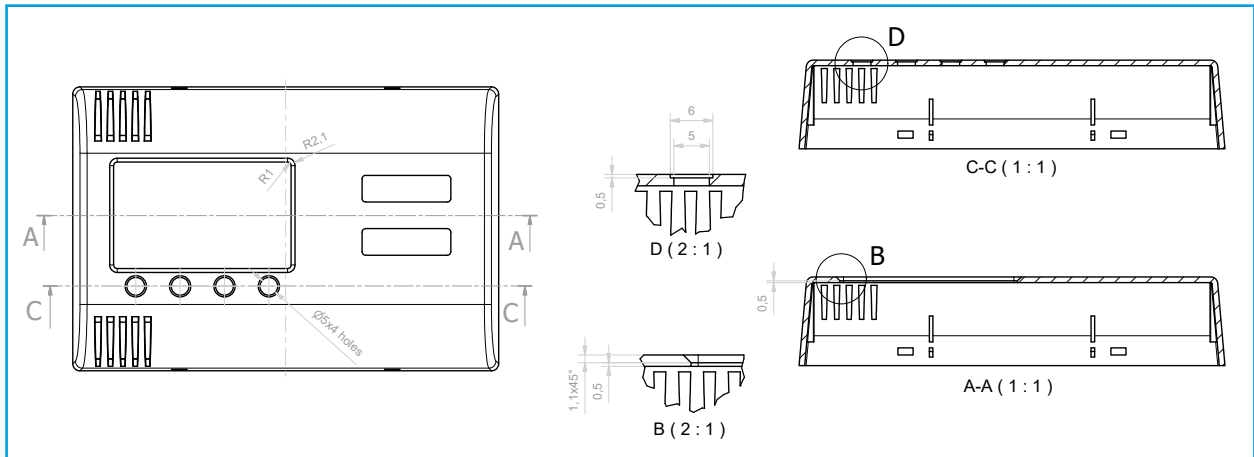

Le tolleranze dimensionali possono essere ristrette se indicate nel disegno del cliente e se compatibili con i nostri processi produttivi: la fornitura del nostro disegno controfirmata fa da garanzia.

The size tolerances can be less if they are indicated in the customer's drawing and are compatible with our production processes: the supply of our countersigned drawing guarantees this.

Tolleranze dimensionali/Tolerance limits

Secondo tolleranze generali UNI EN 22768/1 media (m):

Average tolerances as per UNI EN 22768/1 medium (m):

DA 0.5 A 3 mm/FROM 0.5 TO 3mm	±0.1 mm
DA 3 FINO A 6 mm/FROM 3 TO 6mm	±0.1 mm
OLTRE 6 FINO A 30 mm/BEYOND 6 AND UP TO 30 mm	±0.2 mm
OLTRE 30 FINO A 120 mm/BEYOND 30 AND UP TO 120 mm	±0.3 mm
OLTRE 120 FINO A 400 mm/BEYOND 120 AND UP TO 400 mm	±0.5 mm

STAMPA DIGITALE

La stampa digitale è particolarmente indicata quando sono richiesti molti colori, sfumature e tempi rapidi di esecuzione con costi contenuti; per quantità da basse a medio alte.

Il processo di stampa digitale UV con qualità fotografica permette facilmente di poter avere la massima flessibilità per realizzare qualsiasi tipo di grafica a più colori ad un prezzo competitivo anche per piccoli lotti.

Si tratta di una stampa in quadricromia a getto d'inchiostro successivamente catalizzata a mezzo UV, con una dimensione dei pixel molto ridotta che però non consente di ottenere esattamente la tonalità di colore richiesta (scala RAL o PANTONE).

SPECIFICHE TECNICHE:

Superfici: Stampa su ABS, PC/ABS, PPO, PC, PMMA, PA

Profondità massima: 1,5 mm

Colori: CMYK + bianco

Risoluzione: fino a 1440x1200 dpi

Formato massimo di stampa: 297x420 mm



STAMPA TAMPOGRAFICA

La stampa tampografica è consigliata quando è sufficiente un solo colore e la profondità (scalino) di stampa è superiore a 1,5 mm.

È un procedimento di stampa indiretto, che permette di riprodurre, in modo semplice con elevata fedeltà e risoluzione disegni, scritte e decori sia su superfici piane che su superfici concave, convesse o comunque irregolari. Consigliamo l'impiego di questa tecnologia fino ad un massimo di 2 colori (esempio pannello a 1 o 2 colori) sui nostri coprimorsetti, contenitori e anche pannelli.

SPECIFICHE TECNICHE:

Superfici: Stampa su ABS, PC/ABS, PPO, PC, PMMA, PA

Colori: Tutti

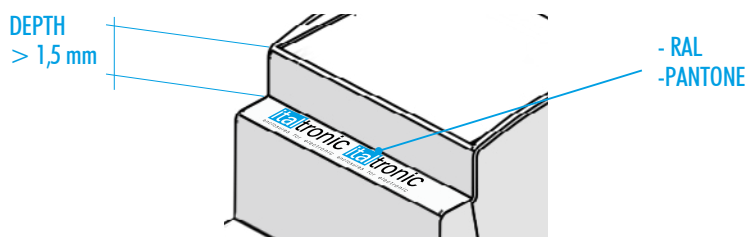

STAMPA SERIGRAFICA

È una tecnologia consolidata di stampa industriale, molto utilizzata in tutte le applicazioni in cui sia richiesto un deposito di inchiostro più elevato rispetto ad altre tecnologie di stampa su superfici piane. Il principio per cui una racle spingendo un inchiostro o una pasta attraverso una maglia aperta di un tessuto tecnico ne ottiene un passaggio uniforme e controllato.

SPECIFICHE TECNICHE:

Superfici: Stampa su ABS, PC/ABS, PPO, PC, PMMA, PA

Colori: Tutti

MARCATURA LASER

Consente l'identificazione permanente (monocromatica) del prodotto anche con tratti molto sottili.

SPECIFICHE TECNICHE:

Superfici: Stampa su ABS, PC/ABS, PPO

Colori: Colore a contrasto a seconda del tipo di materiale

DIGITAL PRINT

Digital printing is ideal when a lot of colours are involved, with shading and fast production with limited costs; for small, medium and large quantities.

The UV digital print process with photographic quality allows maximum flexibility in the realization of any type of graphic in several colours and at a very competitive price, even for small quantities.

It is an inkjet four-colour printing method subsequently catalysed by UV, with a consistently reduced pixel size which, on the other hand, does not guarantee exact colour tonality reproduction (RAL table or pantone).

TECHNICAL SPECS:

Surfaces: Print on ABS, PC/ABS, PPO, PC, PMMA, PA

Maximum depth: 1,5 mm

Colours: CMYK + white

Resolution: up to 1440x1200 dpi

Maximum print size: 297x420 mm

PAD PRINTING

Pad printing is recommended when just one colour is sufficient and the printing depth (step) is more than 1.5 mm.

It is an indirect printing process, which allows reproducing high-fidelity and high resolution drawings, writings and decors, on either flat, concave, convex or anyway irregular surfaces. We suggest this technology for prints up to 2 colour (e.g. a panel in 1 or 2 colours) on our terminal covers, containers and panels, too.

TECHNICAL SPECS:

Surfaces: Print on ABS, PC/ABS, PPO, PC, PMMA, PA

Colours: All

SERIGRAPHY PRINTING

It is a consolidated industrial print system, very much used in all applications requiring thicker ink layers in comparison with other flat-surface print technologies. The principle consists in a blade pushing the ink or paste through hollow tangles of technical fabrics, obtaining a controlled and uniform result.

TECHNICAL SPECS:

Surfaces: Print on ABS, PC/ABS, PPO, PC, PMMA, PA

Colours: all

LASER ENGRAVING

Allows permanent identification (monochrome) of the product, even with very thin strokes.

TECHNICAL SPECS:

Surfaces: Print on ABS, PC/ABS, PPO

Colours: Contrasting colour depending on the material type

Riproducibilità del colore/Colour reproducibility

	SERIGRAFIA/SERIGRAPHY	TAMPOGRAFIA/PAD-PRINTING	DIGITALE/ DIGITAL
FEDELTA' / FIDELITY	90%	90%	100%
COLORE CAMPIONE/SAMPLE COLOUR	100%	100%	60%

italtronic
enclosures for electronics

Italtronic Srl

Corso Stati Uniti 17
35127 Padova - Italy
T. +39 049 8947150
F. +39 049 8947151
www.italtronic.com



X-ON Electronics

Largest Supplier of Electrical and Electronic Components

Click to view similar products for [Enclosures, Boxes & Cases](#) category:

Click to view products by [Italtronic](#) manufacturer:

Other Similar products are found below :

[585-R-WH-PK](#) [M-10-PLATED](#) [60221-01](#) [60566-01-000](#) [HPL-9VB BATT DOOR](#) [M18-PLTD](#) [M-21-PLATED](#) [63310-01-000](#) [6711GSKT](#)
[71884-29-028](#) [LH45-100 Black](#) [72868-510-000](#) [CNS-0000 Black](#) [72883-510-000](#) [CNS-0101 Black](#) [72906-510-000](#) [CNS-0407 Black](#) [73092-](#)
[510-000](#) [CNM-0101 Black](#) [73105-510-000](#) [CNL-0101 Black](#) [73108-510-000](#) [CNL-0303 Black](#) [73395-510-039](#) [CNS-0006 Bone](#) [74016-510-000](#)
[CNL-0006 Black](#) [74257-510-000](#) [CNL-0004](#) [MDC-1183-PLAIN-ALUM](#) [MDC-1183-PTD](#) [MDC-13104-PTD](#) [MDC-321-PTD](#) [MDC-973-PTD](#)
[76](#) [77153-01-028](#) [FLX6030](#) [83535-01-508](#) [90026-501-000](#) [PS36-200](#) [116-508](#) [120-407](#) [120-910](#) [127-908](#) [130-008](#) [1301170079](#)
[1322GSKTEP](#) [1325GSKT3](#) [138-PLAIN](#) [1434-1210](#) [EAS-500 \(BLACK ANO\)](#) [1804RP-RB-PK](#) [190-005](#) [2202307](#) [KAB3321 BLACK](#)
[KAB3421](#) [2697466](#) [S52213](#) [2901123](#) [2901699](#) [A0645271](#) [A20P20](#)