













A WORLD OF ENCLOSURES

EYEBOX
EYEBOX SIMPLE
SHORT FOLDER

www.italtronic.com







italtronic
enclosures for electronics



| | | | |
|---|------------|--|--------|
|  | P61610004C | Eye intermedio batteria 3xaaa per display verticale e orizzontale Eye intermediate battery 3xaaa for display vertical and horizontal | PAG 15 |
|  | P61610005C | Eye intermedio rj45 per display orizzontale e verticale Eye intermediate rj45 for display horizontal and vertical | PAG 15 |
|  | P61610006C | Eye intermedio wago 6pins p4mm per display verticale e orizzontale Eye intermediate wago 6pins p4mm for display vertical and horizontal | PAG 15 |
|  | P61610007C | Eye intermedio knx 4 pins per display orizzontale Eye intermediate knx 4 pins for display horizontal | PAG 16 |
|  | P61610001B | Eye base per fissaggio parete tipo csf Eye base for wall fixing type csf | PAG 16 |
|  | P61610002B | Eye base per fissaggio parete tipo std Eye base for wall fixing std type | PAG 15 |
|  | P61610002A | Eye elemento fissaggio csf su base a parete Eye fixing element csf on wall base | PAG 17 |
|  | P61610003G | Eye ghiera dentata Eye toothed ring | PAG 17 |
|  | P61610001A | Eye ruota dentata per encoder Eye toothed wheel for encoder | PAG 17 |
|  | P61610001G | Eye anello lucido bianco / Eye white shiny frame ring | PAG 18 |
|  | P61610002G | Eye anello zigrinato bianco Eye white knurled ring | PAG 18 |
|  | M612000042 | Eye verniciatura lucida anello ral Eye shiny painting frame ring ral | PAG 18 |
|  | M612000043 | Eye verniciatura opaca anello ral Eye opaque painting frame ring ral | PAG 19 |

EYE BOX

EYEBOX
SIMPLE

| | | | |
|---|------------|--|--------|
|  | 61.6100001 | Eyebox simple kit con base standard Eyebox simple kit with standard base | PAG 24 |
|  | 61.6100002 | Eyebox simple kit con base per CSF Eyebox simple kit with CSF base | PAG 24 |
|  | | Versioni speciali su richiesta - IMD decoration Special versions on demand - IMD decoration | PAG 24 |
|  | | Lavorazioni CNC CNC lavorations | PAG 24 |
|  | PM10012003 | Vite 2,2X6,5 TC+ Screw 2,2X6,5 TC+ | PAG 25 |
|  | P61610003A | Eye copriplacca standard Eye coverplate standard | PAG 25 |
|  | M612000051 | Eye placca per fissaggio a parete o scatola elettrica Eye plate for wall fixing or electric enclosure | PAG 25 |

STAMPA
DIGITALE/
DIGITAL PRINT

Finishing Service / Finishing Service

Pag. 26

EYE BOX BELLEZZA A TUTTO TONDO

La linea di contenitori EYE BOX possiede una ghiera rotativa, cliccabile e personalizzabile in molteplici colori. La superficie inoltre, attraverso una modifica sullo stampo, può presentare una texture materica completamente personalizzabile.

Sono disponibili anche finiture speciali, come il rivestimento in legno, la cromatura e la finitura soft touch. Questo dettaglio conferirà al vostro contenitore uno stile unico.



EYE BOX COLORI

Ogni contenitore può essere personalizzato con infinite colorazioni. Il colore può essere conferito al contenitore per mezzo di una verniciatura RAL o attraverso la scelta del colore master della materia prima, che verrà impiegata direttamente per la produzione.



EYE BOX FINITURE

Verniciatura RAL

Ogni contenitore può essere personalizzato con infinite colorazioni. Il colore può essere conferito al contenitore per mezzo di una verniciatura RAL o attraverso la scelta del colore master della materia prima, che verrà impiegata direttamente per la produzione.

Stampa da master

È possibile realizzare il contenitore direttamente selezionando la matrice plastica colorata. Potrete così disporre di una personalizzazione sull'intera fornitura e rendere il vostro prodotto esclusivo e singolare.

EYE BOX ALL ROUND BEAUTY

he line of EYE BOX enclosures has a rotary, clickable and customizable ring nut in numerous colours. By simply changing the mould, the surface can be finished with a totally customizable texture.

Special finishes are also available, such as wood coating, chrome plating and soft touch finish. This detail will give exclusive style to your enclosure.

EYE BOX COLOURS

Each enclosure can be customised with an infinite range of colours. We can colour your enclosure using RAL paints or by choosing the master colour for the raw material that will be used directly in production.



EYE BOX FINISHES

RAL painting

Each enclosure can be customised with an infinite range of colours. We can colour your enclosure using RAL paints or by choosing the master colour for the raw material that will be used directly in production.

Master mould

The enclosure can be made by choosing a coloured plastic matrix. This will enable customizing your entire supply and make your product unique.

ENCLOSURE SYSTEM EYE BOX

ASSEMBLAGGIO/DISASSEMBLAGGIO

ASSEMBLY/DISASSEMBLY

MONTAGGIO/ASSEMBLY



SMONTAGGIO/DISASSEMBLY

TELAIO

CARATTERISTICHE GENERALI

Materiale: ABS autoestinguento UL94-V0

Colore: Bianco

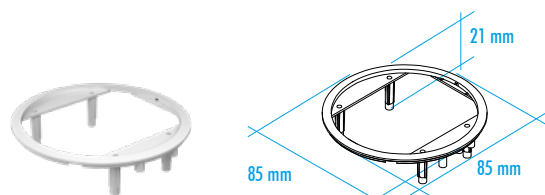

FRAME

GENERAL FEATURES

Material: ABS self-extinguishing UL94-V0

Colour: White



| CODICE / CODE | COLORE / COLOUR | DESCRIZIONE/DESCRIPTION |
|---------------|-----------------|--------------------------------------|
| P61610001T | Bianco/White | Eye telaio superiore / Eye top frame |

| | |
|-------------------------------|----------------|
| CONFEZIONE N° PCS/KIT: | 25 |
| PACKAGING N° PCS/KIT: | 25 |
| PESO DELLA CONFEZIONE: | 0,20 kg |
| PACKAGING WEIGHT: | 0,20 kg |

| | |
|-----------------------------|------------|
| MINIMO ACQUISTABILE: | 1 |
| MINIMUM ORDER: | 1 |
| PESO DEL PEZZO KIT: | 6 g |
| KIT WEIGHT: | 6 g |

TELAIO

CARATTERISTICHE GENERALI

Materiale: ABS autoestinguento UL94-V0

Colore: Bianco

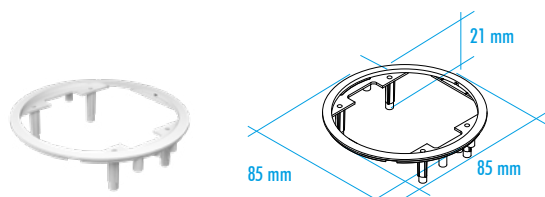

FRAME

GENERAL FEATURES

Material: ABS self-extinguishing UL94-V0

Colour: White



| CODICE / CODE | COLORE / COLOUR | DESCRIZIONE/DESCRIPTION |
|---------------|-----------------|--|
| P61610002T | Bianco/White | Eye telaio superiore - 5 digit / Eye top frame - 5 digit |

| | |
|-------------------------------|----------------|
| CONFEZIONE N° PCS/KIT: | 25 |
| PACKAGING N° PCS/KIT: | 25 |
| PESO DELLA CONFEZIONE: | 0,20 kg |
| PACKAGING WEIGHT: | 0,20 kg |

| | |
|-----------------------------|------------|
| MINIMO ACQUISTABILE: | 1 |
| MINIMUM ORDER: | 1 |
| PESO DEL PEZZO KIT: | 6 g |
| KIT WEIGHT: | 6 g |

VASCHETTA INTERNA

CARATTERISTICHE GENERALI

Materiale: ABS autoestinguento UL94-V0

Colore: Bianco

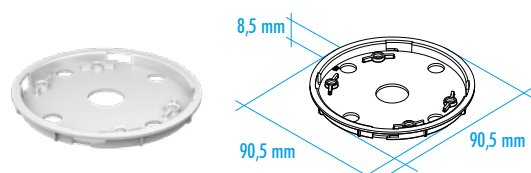

INNER PAN

GENERAL FEATURES

Material: ABS self-extinguishing UL94-V0

Colour: White



| CODICE / CODE | COLORE / COLOUR | DESCRIZIONE/DESCRIPTION |
|---------------|-----------------|---|
| P61610001V | Bianco/White | Eye vaschetta PCB non equipaggiata / Eye PCB enclosure not equipped |

| | |
|-------------------------------|----------------|
| CONFEZIONE N° PCS/KIT: | 25 |
| PACKAGING N° PCS/KIT: | 25 |
| PESO DELLA CONFEZIONE: | 0,48 kg |
| PACKAGING WEIGHT: | 0,48 kg |

| | |
|-----------------------------|-------------|
| MINIMO ACQUISTABILE: | 1 |
| MINIMUM ORDER: | 1 |
| PESO DEL PEZZO KIT: | 12 g |
| KIT WEIGHT: | 12 g |

CORPO CON MOLLE

CARATTERISTICHE GENERALI

Materiale: ABS autoestinguente UL94-V0

Colore: Bianco

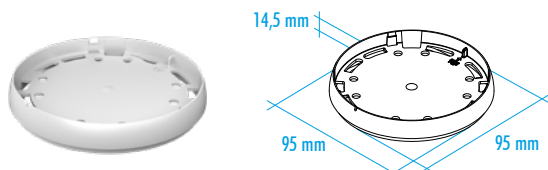

| CODICE / CODE | COLORE / COLOUR | DESCRIZIONE/DESCRIPTION |
|---------------|-----------------|---|
| P61610001C | Bianco/White | Eye intermedio non equipaggiato/Eye intermediate not equipped |

| | |
|-------------------------------|----------------|
| CONFEZIONE N° PCS/KIT: | 25 |
| PACKAGING N° PCS/KIT: | 25 |
| PESO DELLA CONFEZIONE: | 0,60 kg |
| PACKAGING WEIGHT: | 0,60 kg |

| | |
|-----------------------------|-------------|
| MINIMO ACQUISTABILE: | 1 |
| MINIMUM ORDER: | 1 |
| PESO DEL PEZZO KIT: | 18 g |
| KIT WEIGHT: | 18 g |

CORPO CON MOLLE

CARATTERISTICHE GENERALI

Materiale: ABS autoestinguente UL94-V0

Colore: Bianco

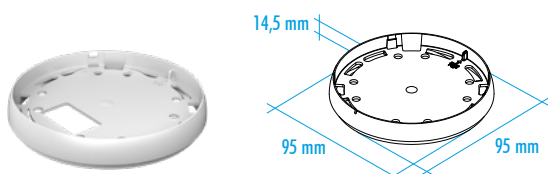

| CODICE / CODE | COLORE / COLOUR | DESCRIZIONE/DESCRIPTION |
|---------------|-----------------|---|
| P61610002C | Bianco/White | Eye intermedio CSF e mor a vite 5 pins p5,08 mm per disp vert e orizz Eye intermediate CSF and screwterminal 5pins p5,08 mm for displayvertical and horiz. |

| | |
|-------------------------------|----------------|
| CONFEZIONE N° PCS/KIT: | 25 |
| PACKAGING N° PCS/KIT: | 25 |
| PESO DELLA CONFEZIONE: | 0,60 kg |
| PACKAGING WEIGHT: | 0,60 kg |

| | |
|-----------------------------|-------------|
| MINIMO ACQUISTABILE: | 1 |
| MINIMUM ORDER: | 1 |
| PESO DEL PEZZO KIT: | 18 g |
| KIT WEIGHT: | 18 g |

CORPO CON MOLLE

CARATTERISTICHE GENERALI

Materiale: ABS autoestinguente UL94-V0

Colore: Bianco

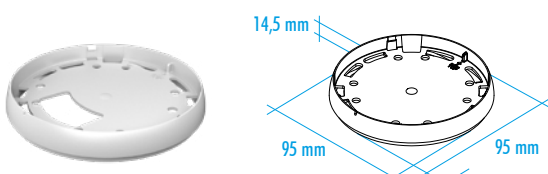

| CODICE / CODE | COLORE / COLOUR | DESCRIZIONE/DESCRIPTION |
|---------------|-----------------|--|
| P61610003C | Bianco/White | Eye intermedio KNX 4 pins p4 mm per display verticale / Eye intermediate KNX 4 pins p4 mm for display vertical |

| | |
|-------------------------------|----------------|
| CONFEZIONE N° PCS/KIT: | 25 |
| PACKAGING N° PCS/KIT: | 25 |
| PESO DELLA CONFEZIONE: | 0,60 kg |
| PACKAGING WEIGHT: | 0,60 kg |

| | |
|-----------------------------|-------------|
| MINIMO ACQUISTABILE: | 1 |
| MINIMUM ORDER: | 1 |
| PESO DEL PEZZO KIT: | 18 g |
| KIT WEIGHT: | 18 g |

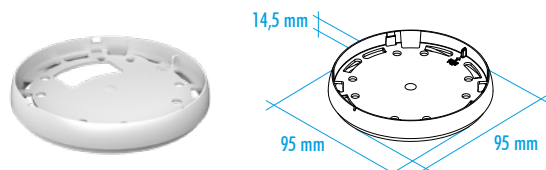
CORPO CON MOLLE**CARATTERISTICHE GENERALI****Materiale:** ABS autoestinguente UL94-V0**Colore:** Bianco**BODY WITH SPRINGS****GENERAL FEATURES****Material:** ABS self-extinguishing UL94-V0**Colour:** White

| CODICE / CODE | COLORE / COLOUR | DESCRIZIONE/DESCRIPTION |
|---------------|-----------------|--|
| P61610007C | Bianco/White | Eye intermedio KNX 4 pins per display orizzontale / Eye intermediate KNX 4 pins for display horizontal |

| | |
|-------------------------------|----------------|
| CONFEZIONE N° PCS/KIT: | 25 |
| PACKAGING N° PCS/KIT: | 25 |
| PESO DELLA CONFEZIONE: | 0,60 kg |
| PACKAGING WEIGHT: | 0,60 kg |

| | |
|-----------------------------|-------------|
| MINIMO ACQUISTABILE: | 1 |
| MINIMUM ORDER: | 1 |
| PESO DEL PEZZO KIT: | 18 g |
| KIT WEIGHT: | 18 g |

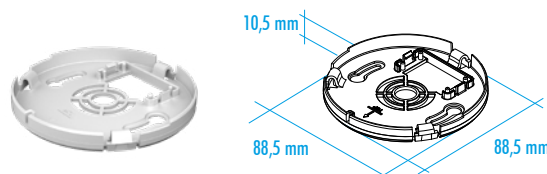
BASE**CARATTERISTICHE GENERALI****Materiale:** ABS autoestinguente UL94-V0**Colore:** Bianco**BASE****GENERAL FEATURES****Material:** ABS self-extinguishing UL94-V0**Colour:** White

| CODICE / CODE | COLORE / COLOUR | DESCRIZIONE/DESCRIPTION |
|---------------|-----------------|--|
| P61610001B | Bianco/White | Eye base per fissaggio parete tipo CSF / Eye base for wall fixing type CSF |

| | |
|-------------------------------|----------------|
| CONFEZIONE N° PCS/KIT: | 25 |
| PACKAGING N° PCS/KIT: | 25 |
| PESO DELLA CONFEZIONE: | 0,42 kg |
| PACKAGING WEIGHT: | 0,42 kg |

| | |
|-----------------------------|-------------|
| MINIMO ACQUISTABILE: | 1 |
| MINIMUM ORDER: | 1 |
| PESO DEL PEZZO KIT: | 14 g |
| KIT WEIGHT: | 14 g |

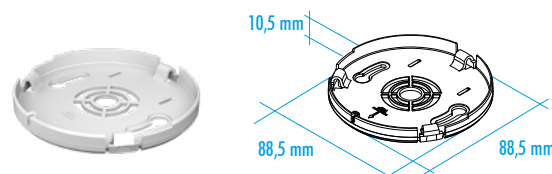
BASE**CARATTERISTICHE GENERALI****Materiale:** ABS autoestinguente UL94-V0**Colore:** Bianco**BASE****GENERAL FEATURES****Material:** ABS self-extinguishing UL94-V0**Colour:** White

| CODICE / CODE | COLORE / COLOUR | DESCRIZIONE/DESCRIPTION |
|---------------|-----------------|--|
| P61610002B | Bianco/White | Eye base per fissaggio parete tipo STD / Eye base for wall fixing type STD |

| | |
|-------------------------------|----------------|
| CONFEZIONE N° PCS/KIT: | 25 |
| PACKAGING N° PCS/KIT: | 25 |
| PESO DELLA CONFEZIONE: | 0,42 kg |
| PACKAGING WEIGHT: | 0,42 kg |

| | |
|-----------------------------|-------------|
| MINIMO ACQUISTABILE: | 1 |
| MINIMUM ORDER: | 1 |
| PESO DEL PEZZO KIT: | 14 g |
| KIT WEIGHT: | 14 g |

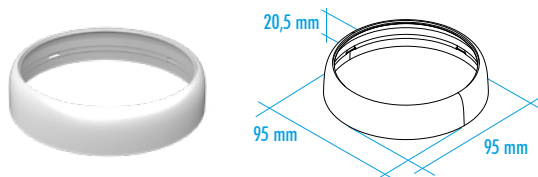
ANELLO**CARATTERISTICHE GENERALI****Materiale:** ABS autoestinguente UL94-V0**Colore:** Bianco**RING****GENERAL FEATURES****Material:** ABS self-extinguishing UL94-V0**Colour:** White

| CODICE / CODE | COLORE / COLOUR | DESCRIZIONE/DESCRIPTION |
|---------------|-----------------|---|
| P61610001G | Bianco/White | Eye anello lucido bianco / Eye white shiny frame ring |

| | |
|-------------------------------|----------------|
| CONFEZIONE N° PCS/KIT: | 25 |
| PACKAGING N° PCS/KIT: | 25 |
| PESO DELLA CONFEZIONE: | 0,55 kg |
| PACKAGING WEIGHT: | 0,55 kg |

| | |
|-----------------------------|-------------|
| MINIMO ACQUISTABILE: | 1 |
| MINIMUM ORDER: | 1 |
| PESO DEL PEZZO KIT: | 14 g |
| KIT WEIGHT: | 14 g |

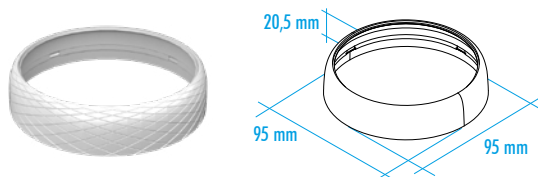
ANELLO**CARATTERISTICHE GENERALI****Materiale:** ABS autoestinguente UL94-V0**Colore:** Bianco**RING****GENERAL FEATURES****Material:** ABS self-extinguishing UL94-V0**Colour:** White

| CODICE / CODE | COLORE / COLOUR | DESCRIZIONE/DESCRIPTION |
|---------------|-----------------|--|
| P61610002G | Bianco/White | Eye anello zigrinato bianco / Eye white knurled ring |

| | |
|-------------------------------|----------------|
| CONFEZIONE N° PCS/KIT: | 25 |
| PACKAGING N° PCS/KIT: | 25 |
| PESO DELLA CONFEZIONE: | 0,55 kg |
| PACKAGING WEIGHT: | 0,55 kg |

| | |
|-----------------------------|-------------|
| MINIMO ACQUISTABILE: | 1 |
| MINIMUM ORDER: | 1 |
| PESO DEL PEZZO KIT: | 14 g |
| KIT WEIGHT: | 14 g |

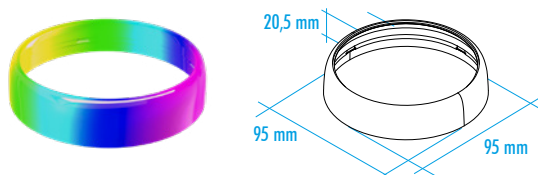
ANELLO**CARATTERISTICHE GENERALI****Materiale:** ABS autoestinguente UL94-V0**Colore:** Verniciato a specifica RAL LUCIDO**RING****GENERAL FEATURES****Material:** ABS self-extinguishing UL94-V0**Colour:** Painted in according request RAL SHINY

| CODICE / CODE | COLORE / COLOUR | DESCRIZIONE/DESCRIPTION |
|---------------|-----------------|--|
| M612000042 | RAL | Eye verniciatura lucida anello RAL / Eye shiny painting frame ring RAL |

| | |
|-------------------------------|----------------|
| CONFEZIONE N° PCS/KIT: | 25 |
| PACKAGING N° PCS/KIT: | 25 |
| PESO DELLA CONFEZIONE: | 0,55 kg |
| PACKAGING WEIGHT: | 0,55 kg |

| | |
|-----------------------------|-------------|
| MINIMO ACQUISTABILE: | 1 |
| MINIMUM ORDER: | 1 |
| PESO DEL PEZZO KIT: | 14 g |
| KIT WEIGHT: | 14 g |

GRAFICA CARATTERISTICHE GENERALI

Stampa di fondo in nero per display circolare Ø43 mm, su pannello frontale trasparente

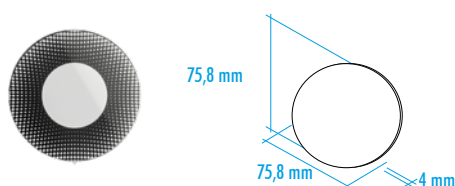

| CODICE / CODE | DESCRIZIONE/DESCRIPTION |
|---------------|---|
| M612000047 | Eye grafica circolare per TFT 2,8" Ø 43 mm bubble / Eye circular graphics TFT 2,8" Ø 43 mm bubble |

GRAPHIC GENERAL FEATURES

Black background printing for circular display Ø43 mm, front transparent panel use



| | | | |
|-------------------------------|----------------|-------------------------------|-------------|
| CONFEZIONE N° PCS/KIT: | 25 | MINIMO ACQUISTABILE: 1 | 1 |
| PACKAGING N° PCS/KIT: | 25 | MINIMUM ORDER: | 1 |
| PESO DELLA CONFEZIONE: | 0,50 kg | PESO DEL PEZZO KIT: | 16 g |
| PACKAGING WEIGHT: | 0,50 kg | KIT WEIGHT: | 16 g |

GRAFICA CARATTERISTICHE GENERALI

Stampa di fondo in nero per display circolare Ø43 mm, su pannello frontale trasparente

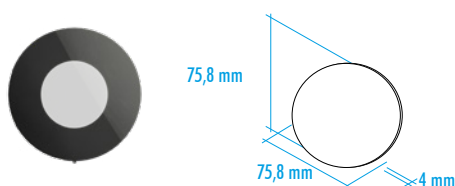

| CODICE / CODE | DESCRIZIONE/DESCRIPTION |
|---------------|---|
| M612000048 | Eye grafica circolare per TFT 2,8" Ø 43 mm / Eye circular graphics for TFT 2,8" Ø 43 mm |

GRAPHIC GENERAL FEATURES

Black background printing for circular display Ø43 mm, front transparent panel use



| | | | |
|-------------------------------|----------------|-------------------------------|-------------|
| CONFEZIONE N° PCS/KIT: | 25 | MINIMO ACQUISTABILE: 1 | 1 |
| PACKAGING N° PCS/KIT: | 25 | MINIMUM ORDER: | 1 |
| PESO DELLA CONFEZIONE: | 0,50 kg | PESO DEL PEZZO KIT: | 16 g |
| PACKAGING WEIGHT: | 0,50 kg | KIT WEIGHT: | 16 g |

GRAFICA CARATTERISTICHE GENERALI

Grafica per display circolare led 5 digit, su pannello frontale trasparente

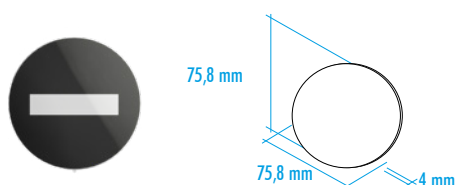

| CODICE / CODE | DESCRIZIONE/DESCRIPTION |
|---------------|---|
| M612000049 | Eye grafica per display led 5 digit / Eye graphics for display led 5 digits |

GRAPHIC GENERAL FEATURES

Graphic for display led 5 digits, for transparent front panel use



| | | | |
|-------------------------------|----------------|-------------------------------|-------------|
| CONFEZIONE N° PCS/KIT: | 25 | MINIMO ACQUISTABILE: 1 | 1 |
| PACKAGING N° PCS/KIT: | 25 | MINIMUM ORDER: | 1 |
| PESO DELLA CONFEZIONE: | 0,50 kg | PESO DEL PEZZO KIT: | 16 g |
| PACKAGING WEIGHT: | 0,50 kg | KIT WEIGHT: | 16 g |

VITE CARATTERISTICHE GENERALI

SCREW GENERAL FEATURES



| CODICE / CODE | DESCRIZIONE/DESCRIPTION |
|---------------|--|
| PMT0012003 | Vite 2,2x6,5 TC + / Screw 2,2x6,5 TC + |

| | |
|------------------------|---------|
| CONFEZIONE N° PCS/KIT: | 1000 |
| PACKAGING N° PCS/KIT: | 1000 |
| PESO DELLA CONFEZIONE: | 0,20 kg |
| PACKAGING WEIGHT: | 0,20 kg |

| | |
|----------------------|-------|
| MINIMO ACQUISTABILE: | 1000 |
| MINIMUM ORDER: | 1000 |
| PESO DEL PEZZO KIT: | 0,1 g |
| KIT WEIGHT: | 0,1 g |

VITI/SCREWS

ACCESSORI CARATTERISTICHE GENERALI

Materiale: ABS autoestinguente UL94-V0
Colore: Bianco
Copriplacca rettangolare

ACCESSORIES GENERAL FEATURES

Material: ABS self-extinguishing UL94-V0
Colour: White
Rectangular cover

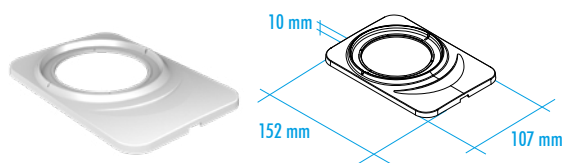

| CODICE / CODE | COLORE / COLOUR | DESCRIZIONE/DESCRIPTION |
|---------------|-----------------|--|
| P61610003A | Bianco/White | Eye copriplacca standard / Eye coverplate standard |

| | |
|------------------------|---------|
| CONFEZIONE N° PCS/KIT: | 25 |
| PACKAGING N° PCS/KIT: | 25 |
| PESO DELLA CONFEZIONE: | 0,85 kg |
| PACKAGING WEIGHT: | 0,85 kg |

| | |
|----------------------|------|
| MINIMO ACQUISTABILE: | 1 |
| MINIMUM ORDER: | 1 |
| PESO DEL PEZZO KIT: | 30 g |
| KIT WEIGHT: | 30 g |

ACCESSORI CARATTERISTICHE GENERALI

Materiale: ABS autoestinguente UL94-V0
Colore: Bianco
Placca per fissaggio su scatola elettrica rettangolare 503, UK, USA oppure quadrata, Ø60 mm

ACCESSORIES GENERAL FEATURES

Material: ABS self-extinguishing UL94-V0
Colour: White
Plate for rectangular electrical enclosure use type 3 gang, UK, USA or quadratik

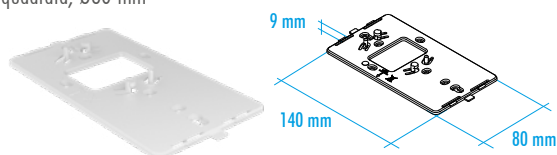

| CODICE / CODE | COLORE / COLOUR | DESCRIZIONE/DESCRIPTION |
|---------------|-----------------|---|
| P61610004A | Bianco/White | Eye placca per fissaggio a parete o scatola elettrica / Eye plate for wall fixing or electric enclosure |

| | |
|------------------------|---------|
| CONFEZIONE N° PCS/KIT: | 25 |
| PACKAGING N° PCS/KIT: | 25 |
| PESO DELLA CONFEZIONE: | 0,60 kg |
| PACKAGING WEIGHT: | 0,60 kg |

| | |
|----------------------|------|
| MINIMO ACQUISTABILE: | 1 |
| MINIMUM ORDER: | 1 |
| PESO DEL PEZZO KIT: | 20 g |
| KIT WEIGHT: | 20 g |

ACCESSORI/ACCESSORIES

EYEBOX SIMPLE

CARATTERISTICHE GENERALI

Materiale: ABS autoestingente V0

Colore: Bianco

Misure: DIAM. 94,6 x H. 37,4 mm

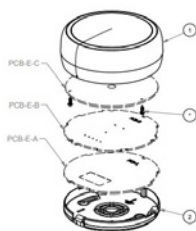

EYEBOX SIMPLE

GENERAL FEATURES

Material: ABS autoestingente V0

Colour: Bianco

Dimension: DIAM. 94,6 x H. 37,4 mm



CODICE / CODE

DESCRIZIONE/DESCRIPTION

61.6100001

Eyebox simple kit con base standard / Eyebox simple kit with standard base

| | |
|-------------------------------|---------------|
| CONFEZIONE N° PCS/KIT: | 50 |
| PACKAGING N° PCS/KIT: | 50 |
| PESO DELLA CONFEZIONE: | 3,8 kg |
| PACKAGING WEIGHT: | 3,8 kg |

| | |
|-----------------------------|-------------|
| MINIMO ACQUISTABILE: | 1 |
| MINIMUM ORDER: | 1 |
| PESO DEL PEZZO KIT: | 58 g |
| KIT WEIGHT: | 58 g |

EYEBOX SIMPLE

CARATTERISTICHE GENERALI

Materiale: ABS autoestingente V0

Colore: Bianco

Misure: DIAM. 94,6 x H. 37,4 mm

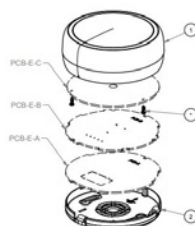

CODICE / CODE

DESCRIZIONE/DESCRIPTION

61.6100002

Eyebox simple kit con base per CSF / Eyebox simple kit with CSF base

| | |
|-------------------------------|---------------|
| CONFEZIONE N° PCS/KIT: | 50 |
| PACKAGING N° PCS/KIT: | 50 |
| PESO DELLA CONFEZIONE: | 3,8 kg |
| PACKAGING WEIGHT: | 3,8 kg |

| | |
|-----------------------------|-------------|
| MINIMO ACQUISTABILE: | 1 |
| MINIMUM ORDER: | 1 |
| PESO DEL PEZZO KIT: | 58 g |
| KIT WEIGHT: | 58 g |

EYEBOX SIMPLE

ESEMPI DI VERSIONI SPECIALI SU RISCHIESTA CON IMDT



EYEBOX SIMPLE

SPECIAL VERSIONS EXAMPLES ON DEMAND WITH IMDT

EYEBOX SIMPLE

ESEMPI DI LAVORAZIONI CNC



EYEBOX SIMPLE

CNC LAVORATIONS EXAMPLES

FINISHING SERVICE

ITALTRONIC è da tempo impegnata nella fornitura dei propri contenitori completi di servizi aggiuntivi vari per il completamento dei prodotti esteticamente e meccanicamente. Per fare ciò si è dotato di un ufficio tecnico che può tradurre le note della clientela in disegni esecutivi prima e in campionature per la valutazione finale della corrispondenza al progetto.

Alcuni servizi sono completamente GRATUITI, cioè quando il cliente fornisce dei documenti tecnici già conformi al post process che ITALTRONIC dovrà fare, altri invece sono a pagamento: generalmente quando ITALTRONIC deve sviluppare un progetto sui propri contenitori oppure adattare le informazioni ricevute agli STANDARD necessari per avviare la produzione.

Qui di seguito troverete una semplice traccia di quelle che sono le richieste minime di ITALTRONIC affinché la gestione possa essere veloce, semplice e gratuita, fatto salvo i costi di attrezzatura di base; altrimenti saranno addebitati i costi relativi alle attività svolte dai tecnici ITALTRONIC al puro costo aziendale.

PERSONALIZZAZIONE MECCANICA

Stiamo in grado di fornire un servizio di personalizzazione meccanica del prodotto con l'ausilio di macchine per fresatura CNC, taglio e tranciatrice.

Lavorazioni meccaniche su superfici: ABS, PC/ABS, PPO, PC, PMMA, PA

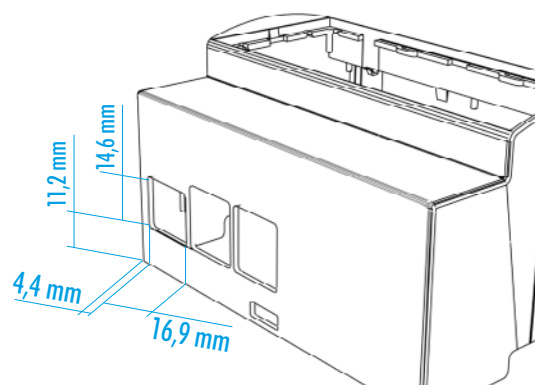

SPECIFICHE TECNICHE RICHIESTE

File: .dwg, .dxf o STEP

Dimensioni: Scala 1:1

In caso contrario, verranno addebitati i costi in base alla complessità nel creare un file di lavorazione. Come modello per la creazione di un file abbiamo bisogno di un disegno/schizzo che contenga tutte le dimensioni di lavorazione pertinenti.

EXTRA COST



OK



EXTRA COST



SPECIFICHE TECNICHE GARANTITE

Centraggio delle lavorazioni

La centratura di tutte le lavorazioni eseguite da Italtronic è sottoposta a un controllo finale con uno strumento semplice come il calibro.

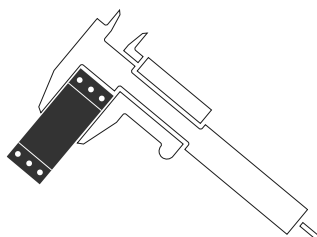

FINISHING SERVICE

For years ITALTRONIC has been working to supply its enclosures with the various additional services to complete the products both externally and mechanically. To do this, we have set up our technical office that is able to translate our customers' notes into initial project drawings and samples to enable a final evaluation of whether they correspond to the project.

Some services are FREE OF CHARGE, i.e. when the customer gives us the technical documents that already conform to the post processing ITALTRONIC has to do, while others are for a fee: usually when ITALTRONIC has to develop a project on its own enclosures, or adapt the information received to the necessary production STANDARDS.

Below you will find a simple guide of the ITALTRONIC minimum requests so that the process can be quick, simple and free, apart from the basic equipment costs, otherwise we will charge you for the work of our ITALTRONIC technicians at the pure cost price.

MECHANICAL PERSONALIZATION

We can supply a product mechanical personalization service with the aid of milling, CNC, cutting and trenching machines.

Mechanical processing: on ABS, PC/ABS, PPO, PC, PMMA, PA surfaces

TECHNICAL SPECS REQUEST

File: .dwg, .dxf o STEP

Dimensions: 1:1 scale

Otherwise, additional costs will be charged, according to the complexity of the print file preparation. As guideline for the final print file, we need to have a drawing / sketch showing all pertinent working dimensions.

GUARANTEED TECHNICAL SPECS

Centring the work

The centring for all the work by Italtronic undergoes a final control using a simple tool, like a gauge.

PERSONALIZZAZIONE GRAFICA

ITALTRONIC fornisce un ottimo servizio di personalizzazione grafica sui propri prodotti. È opportuno prendere visione delle note più sotto per ottenere risposte veramente veloci e costi ridotti al minimo.

Nota: Tutti i contenuti devono essere modificabili (generalmente i file non vettoriali non sono modificabili)

In caso contrario, verranno addebitati i costi in base alla complessità nel creare un file di stampa. Per la creazione di un file di stampa a partire da zero abbiamo bisogno di un disegno / schizzo che contenga tutte le dimensioni di lavorazione pertinenti. Se non è possibile fornire i loghi, i simboli (come file di immagine, ad es. Jpg con risoluzione min. 1200 dpi) o eventuali caratteri speciali, sono possibili lievi non conformità.

DOCUMENTAZIONE TECNICA RICHIESTA DA ITALTRONIC

File di stampa ottimale: layout deve sempre essere una grafica vettoriale (no grafica raster) in formato Adobe Illustrator, EPS, file .pdf vettoriale o Corel Draw.

EXTRA COST



OK

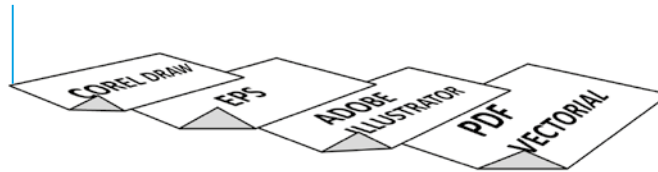

EXTRA COST



Nel caso in cui parte del file (o tutto il file non sia vettoriale, potremo accettare file con le caratteristiche: scala 1:1, inclusi file di immagine, ad esempio jpg o bmp risoluzione minima 1200 dpi.

In case part of the file (or the entire file) is not a vector graphic, we may consider files having the following characteristics: scale 1:1, including image files such as jpg or bmp, 1200 dpi minimal resolution.



Nota: Esempio file immagine alta risoluzione (1200 dpi)
Note: High resolution image file example (1200 dpi)

Nota: Esempio file immagine bassa risoluzione (<1200 dpi)
Note: Low resolution image file example (<1200 dpi)

SPECIFICHE TECNICHE GARANTITE

CENTRAGGIO DELLE STAMPE

La centratura di tutte le lavorazioni eseguite da ITALTRONIC è sottoposta a un controllo finale con uno strumento semplice come il calibro.

Qui sotto riportiamo un esempio di come possono essere eseguite delle misure affinché risultino centrate con altri processi, come quello di CNC, e siano ortogonali ai piani di riferimento dei nostri prodotti.

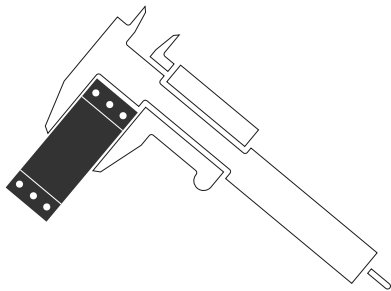

Le tolleranze possono essere ristrette se indicate nel disegno del cliente e se compatibili con i nostri processi produttivi: la fornitura del nostro disegno controfirmato fa da garanzia.

GUARANTED TECHNICAL SPECS

PRINTING CENTRING

The centring for all the work by Italtronic undergoes a final control using a simple tool, like a gauge.

Below is an example of how the measurements can be taken so that they are centred with other processes, such as CNC, and are at right angles to the reference surfaces of our products.

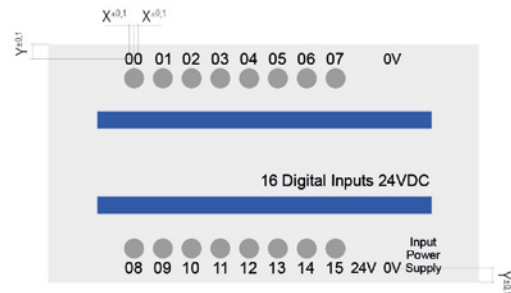

The size tolerances can be less if they are indicated in the customer's drawing and are compatible with our production processes: the supply of our countersigned drawing guarantees this.

Tolleranze dimensionali/Tolerance limits

Con stampa di forma (mm) secondo tolleranze generali UNI EN 22768/1 media (m):

With dye (mm) printing having average tolerances as per UNI EN 22768/1 medium (m):

| | |
|---|--|
| DA 0.5 A 3 mm/FROM 0.5 TO 3 mm | ±0.1 mm |
| DA 3 FINO A 6 mm/FROM 3 TO 6 mm | ±0.1 mm |
| OLTRE 6 FINO A 30 mm/BEYOND 6 AND UP TO 30 MM | ±0.2 mm |
| OLTRE 30 FINO A 120 mm/BEYOND 30 AND UP TO 120 mm | ±0.3 mm |
| OLTRE 120 FINO A 400 mm/BEYOND 120 AND UP TO 400 mm | ±0.5 mm |
| VARIAZIONI PERMESSE/PERMITTED VARIATIONS | Ampiezza della linea ± 10%/Line extent ± 10% |
| TOLLERANZA DI SPAZI VUOTI/EMPTY SPACE TOLERANCE | Contorno esterno e ritagli (mm) ± 0.3*/External contour and cropping (mm) ± 0.3* |

Note

EYE BOX

A series of horizontal dashed lines for writing notes, spanning the width of the page.

italtronic
enclosures for electronics

Italtronic Srl

Corso Stati Uniti 17
35127 Padova - Italy
T. +39 049 8947150
F. +39 049 8947151
www.italtronic.com



X-ON Electronics

Largest Supplier of Electrical and Electronic Components

Click to view similar products for [Enclosures, Boxes & Cases](#) category:

Click to view products by [Italtronic](#) manufacturer:

Other Similar products are found below :

[585-R-WH-PK](#) [M-10-PLATED](#) [60221-01](#) [60566-01-000](#) [HPL-9VB BATT DOOR](#) [M18-PLTD](#) [M-21-PLATED](#) [63310-01-000](#) [6711GSKT](#)
[71884-29-028](#) [LH45-100 Black](#) [72868-510-000](#) [CNS-0000 Black](#) [72883-510-000](#) [CNS-0101 Black](#) [72906-510-000](#) [CNS-0407 Black](#) [73092-](#)
[510-000](#) [CNM-0101 Black](#) [73105-510-000](#) [CNL-0101 Black](#) [73108-510-000](#) [CNL-0303 Black](#) [73395-510-039](#) [CNS-0006 Bone](#) [74016-510-000](#)
[CNL-0006 Black](#) [74257-510-000](#) [CNL-0004](#) [MDC-1183-PLAIN-ALUM](#) [MDC-1183-PTD](#) [MDC-13104-PTD](#) [MDC-321-PTD](#) [MDC-973-PTD](#)
[76](#) [77153-01-028](#) [FLX6030](#) [83535-01-508](#) [90026-501-000](#) [PS36-200](#) [116-508](#) [120-407](#) [120-910](#) [127-908](#) [130-008](#) [1301170079](#)
[1322GSKTEP](#) [1325GSKT3](#) [138-PLAIN](#) [1434-1210](#) [EAS-500 \(BLACK ANO\)](#) [1804RP-RB-PK](#) [190-005](#) [2202307](#) [KAB3321 BLACK](#)
[KAB3421](#) [2697466](#) [S52213](#) [2901123](#) [2901699](#) [A0645271](#) [A20P20](#)