



Electronic Components

Connector Product Locations

GERMANY
Cannonstrasse 1
Weinstadt, 71384
phone: 49.7151.699.0
fax: 49.7151.699.217

HONG KONG
Unit 901 & 912, West Tower
Shun Tak Center
168-200 Connaught Road
Central
phone: 852.2732.2720
fax: 852.2732.2919

ITALY
Via Pietro Panzeri 10
Milano, 20123
phone: 39.2.58180.1
fax: 39.2.8372036

UK
Jays Close, Viabes Estate
Basingstoke, RG22 4BA
phone: 44.1256.311200
fax: 44.1256.323356

USA
666 East Dyer Road
Santa Ana, CA 92705
toll free: 1.800.854.3028
phone: 1.714.557.4700
fax: 1.714.628.2142

SURE-SEAL Connectors

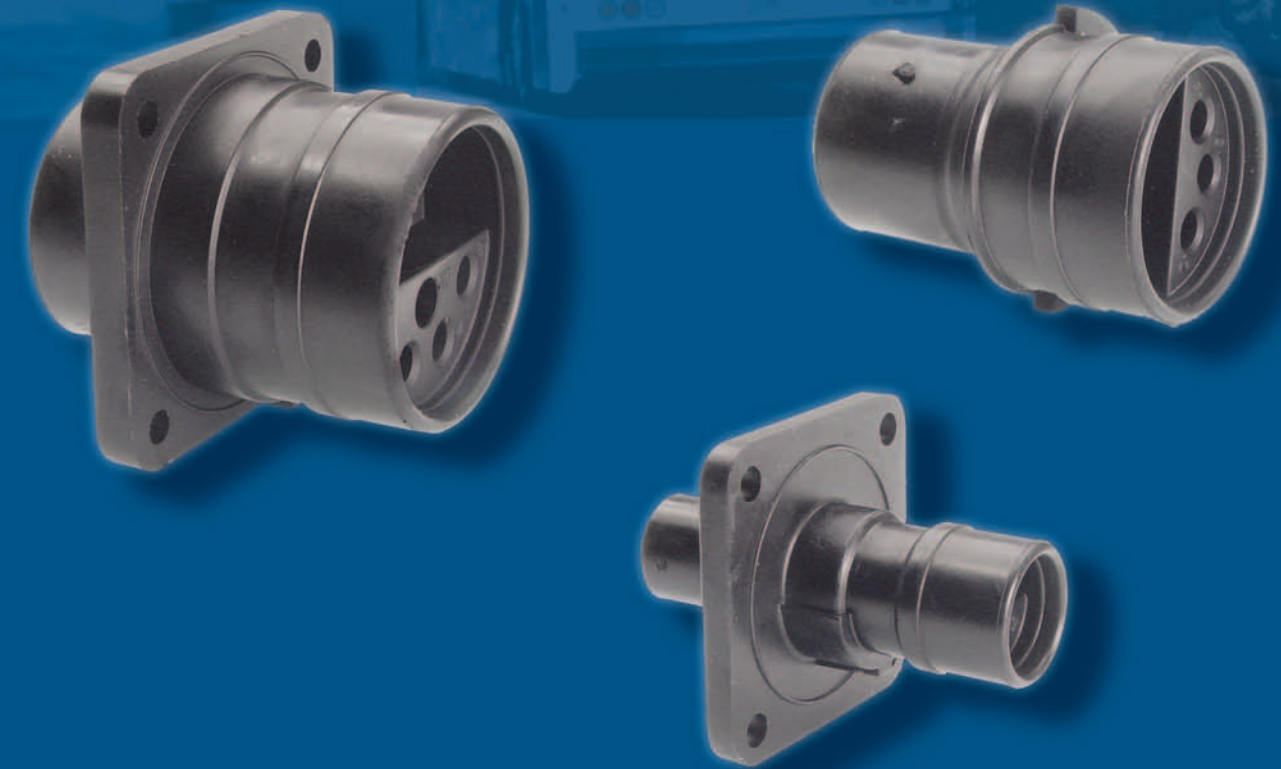

"Engineered for life" is a registered trademark of ITT Industries. ©2006. All data subject to change without notice.

Sure-Seal 06-Mar

www.ittcannon.com

Engineered for life

Reliability. Low Cost.

Performance. Delivery.

SURE-SEAL connectors – a series of low cost, UL and CSA recognized environmental connectors.

The one-piece molded body and rugged multiple moisture seals make the SURE-SEAL connector a natural for applications whose outside contaminants must be excluded.

One of the many features of the SURE-SEAL connector is its simplicity. In addition to the contacts, only two other parts – the connector bodies – are required to complete the interconnect.

SURE-SEAL connectors were designed to meet the increased requirements for safety and reliability in the automotive field brought about by Department of Transportation regulations. These sealed connectors satisfy all of the parameters defined by automotive / industrial standards including vibration, shock, temperature cycling, salt water spray and immersion, petroleum derivatives, industrial gas, and most important low millivolt drop and low contact resistance.

Low Installed Cost

SURE-SEAL connectors are designed to be terminated by the O.E.M.

Field Service

When necessary, SURE-SEAL connectors can be changed, modified or wired in the field.

One-Piece Molded Bodies

The SURE-SEAL connector incorporates a very simple one-piece molded body. No other parts – other than contacts – are needed to assemble a complete connector.

Low Cost Stamped Contacts

Without sacrificing quality, the cost of SURE-SEAL connectors is kept low by using stamped contacts available on reels in a continuous strip for use on the industry accepted 94-4510 or ACT 2500 semi automatic crimp press. All contacts utilize a “B” type crimp.

Wide Wire Gage and Cable Accommodations

Ideally suited to be terminated on wires of size 0,5–1,5 mm² (AWG 14-20), wire sizes with insulation in the range of 1,4–1,8, 1,8–2,8 and 2,4–3,3 mm, termination to multiconductor jacketed cables in the range of 5,3 to 8,4 mm diameter, and can be terminated to three different wire ranges with total environmental sealing still assured.

Polarized Against Mis-Mates

SURE-SEAL connector mating faces are constructed with two stepped planes; the plug and receptacle must be properly oriented in order for the contacts to engage. For “blind” mating a raised indexing rib and matching raised indexing spline has been added to the plug and receptacle.

Water Submersible

Not just splash proof, but truly submersible for short periods of time. SURE-SEAL fulfills the requirements according to IP66A, DIN 40050. Note: Although SURE-SEAL can withstand submersion, it is not designed to be an underwater connector.

Resistant to Automotive/Commercial Environment

SURE-SEAL connectors are designed to meet temperatures from –40°C to 105°C under conditions of high humidity severe vibration, ice and mud. Sealing integrity is still maintained with exposure to brake fluid, gasoline, diesel fuel, anti-freeze, ultra violet, ozone, steam cleaning under normal operating conditions.

Color coded

SURE-SEAL connectors are available in black, red, yellow, and green to avoid mismatching of other SURE-SEAL connectors with the same contact arrangement.

Environment & Health

RoHS compliant

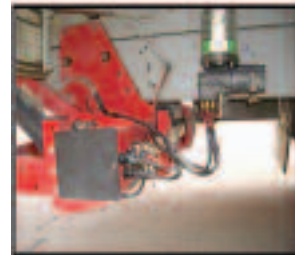

The ITT “Engineered Blocks” symbol and the composite ITT logo are registered trademarks of ITT Industries. © 2006.

Interconnect Technologies & Solutions for the Transportation Industry

For over 90 years, ITT has been developing innovative solutions for harsh environment applications. We have a proven track record of demonstrating our expertise and commitment to the transportation industry, offering the broadest portfolio of interconnect products.

Our interconnect range include sealed circulars, plastic and metal shell bayonet coupling circulars, miniature metal shell circulars, PC board header connectors and sensor and direct device connectors. ITT is also a systems supplier, providing value-added module and harness assemblies.

In addition to the SURE-SEAL series, we also offer these connectivity solutions:

Environmentally Sealed



Cannon APD

In-line and bulkhead connectors resistant to harsh environmental conditions (contaminants, vibration and shock).



Cannon CA-Bayonet

Signal and power connectors with exceptional sealing against the ingress of fluids and will withstand the effects of high vibrations.

Harsh Environments



Cannon Trident

Versatile range of electrical connectors based on a standard contact design. Options include; industrial grade, harsh environment and shielded circulars.



Cannon SLC/SLE

Environmentally sealed connector created for printed circuit board, black box, cable-to-cable or bulkhead applications.

Table of Contents

Introduction	2
Features	2
Standard Data	5
Mini SURE-SEAL	
Contact Arrangements	
Part Numbers	
Dimensions	6-7
SURE-SEAL	
Components	
Contact Arrangements	
Part Numbers	
Dimensions	8-11
SURE-SEAL Accessories	
Tools	
Wiring Instructions	24-25
Product Safety Information	26



Design

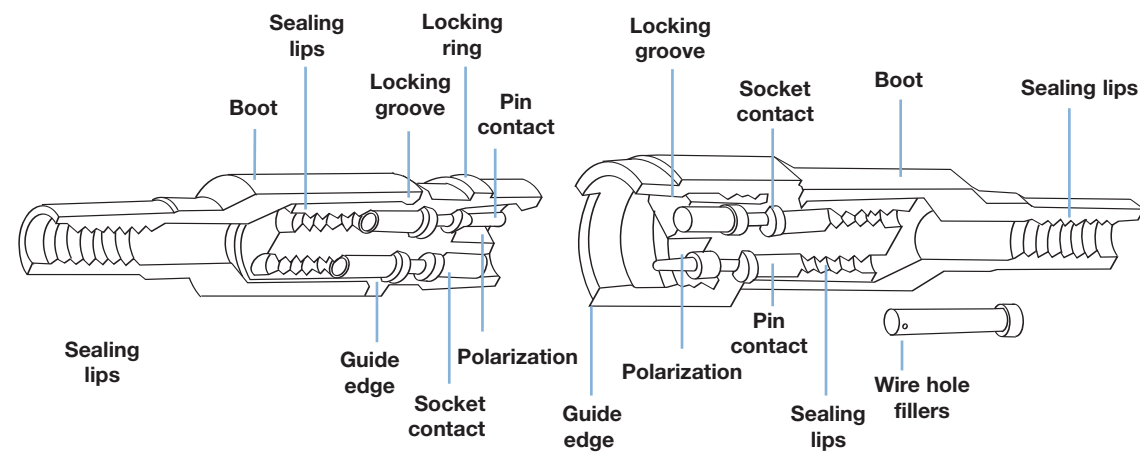

Standard Data

Materials and finishes

Plug and receptacle	Perbunan or Nitril-Butadien rubber
Contacts, stamped	Copper alloy, tin plate
Contacts, machined	Copper alloy, hard silver plate

Mechanical Data

Crimp contacts	Semi-automatic or hand crimpable
Contact positions	1 thru 10 inclusive
Polarization	Stepped plane positive polarization and visual polarization
Contact retention	35 N minimum
Contact insertion	From rear with simple hand tool, or simultaneous insertion of multiple crimped contacts with semi-automatic insertion machine

Max. operating temperature acc. to DIN IEC 68, part 1 -40/105° C

Test Criteria

Sealing capability	IP 67 acc. to DIN 40050
Weather, ozone and ultra violet resistance	In accordance with ASTM D-1149 (100 pphm) and ASTM D-1171 (outdoor exposure)
Industrial gas	Equivalent to MIL-C-23216, para 4.6.13
Durability	50 cycles mating and unmating
Salt spray	In accordance with MIL-STD-202D, Method 101 D and DIN 400046, part 11
Humidity	95% at 95° C/1000 hours
Dry heat	105° C for 1000 hours
Vibration	10 to 55 Hz, .06" DA, 1 hour, X and Y planes
Shock	50 g, 11ms, 30 cycles, X and Y planes

Electrical Data Mini SURE-SEAL

Contact resistance	10 Milliohms max.
Insulation resistance	100 Mohms min.
Dielectric withstanding voltage	1200 VAC at sea level
Wire range	0,4-0,75 mm ² (AWG 20-18)
Wire insulation sealing range	1,4-1,8 mmØ
Insulation stripping length	3,0-3,3 mm

Electrical Data SURE-SEAL

Contact resistance	10 Milliohms max.
Insulation resistance	100 Mohms min.
Dielectric withstanding voltage	1200 VAC at sea level
Wire range	0,75-1,5 mm ² (AWG 18-14) 0,50-1,0 mm ² (AWG 20-16)
Wire insulation Sealing range	2,4-3,3 resp. 1,8-2,8 mmØ
Insulation stripping length	3,9-4,7 mm

Current rating - SURE-SEAL

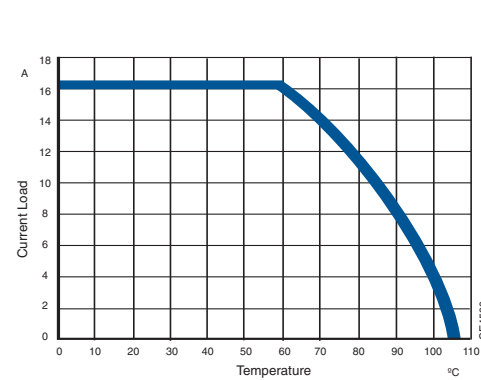

Current rating - Mini SURE-SEAL

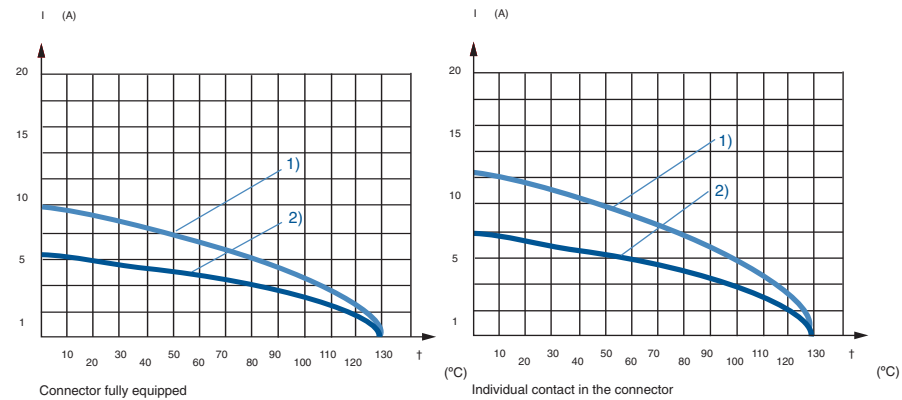

1) APK - _ _ 10_07-0,75qmm*
2) APK - _ _ 10_07-0,35qmm*



Contact Arrangements

● Pin ○ Socket

Receptacle

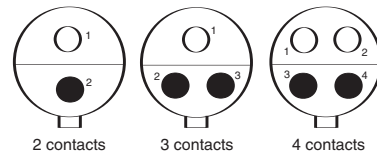

Plug

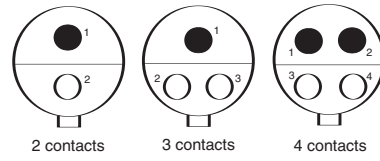

Part Numbers

Plug		black	red	green	yellow
No. of contacts	Shell size				
2	MSS 2 P	120-8552-100	120-8552-110	120-8552-120	120-8552-130
3	MSS 3 P	120-8552-101	120-8552-111	120-8552-121	120-8552-131
4	MSS 4 P	120-8552-102	120-8552-112	120-8552-122	120-8552-132

Receptacle

Receptacle		black	red	green	yellow
No. of contacts	Shell size				
2	MSS 2 R	120-8551-100	120-8551-110	120-8551-120	120-8551-130
3	MSS 3 R	120-8551-101	120-8551-111	120-8551-121	120-8551-131
4	MSS 4 R	120-8551-102	120-8551-112	120-8551-122	120-8551-132

Contacts, stamped

With insulation support

			Pins	Sockets	Wire hole fillers
Mini SURE-SEAL	0,5–0,75 mm ²	individual	330-8672-100	031-8703-100	225-1012-000
		on reels, 5000 pcs.	MSS 121348-100	MSS 121347-100	225-1012-000

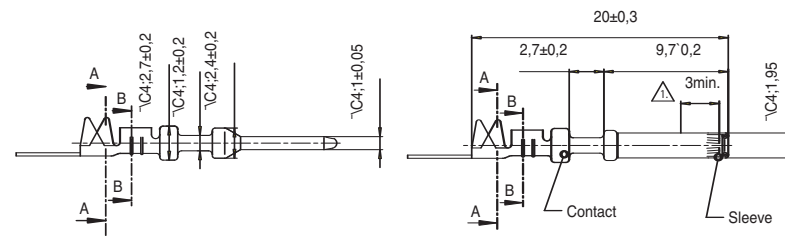
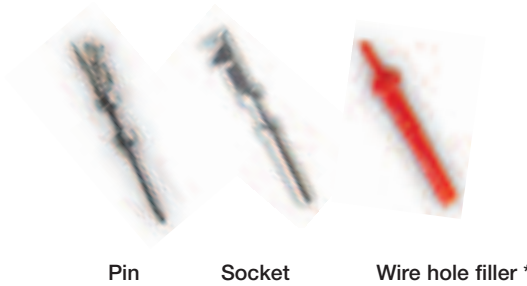

* Wire hole fillers are inserted into unused cavities instead of a contact in order to create a watertight sealing.

Mini SURE-SEAL

Plug

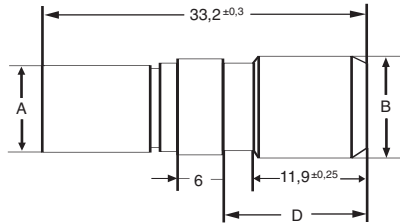

Receptacle

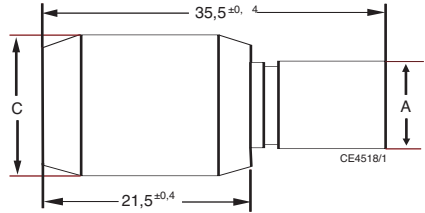

Shell size	Ø A ± 0,15	Ø B - 0,2	Ø C - 0,3	Ø D ± 0,3
MSS 2 P/R	8,2	9,6	13,4	16,3
MSS 3 P/R	8,8	10,4	14,3	13,4
MSS 4 P/R	8,8	11,0	15,0	13,4

Contacts, machined

	Pins	Sockets	Wire hole fillers	
Mini SURE-SEAL 0,4–0,75 mm ²	individual	330-8672-005	031-8703-052	225-1012-000



Pin Socket Wire hole filler *

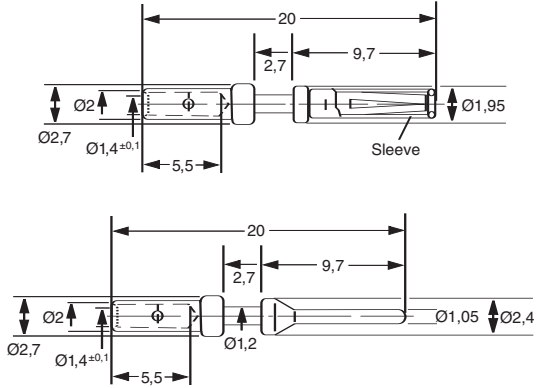

* Wire hole fillers are inserted into unused cavities instead of a contact in order to create a watertight sealing.



Receptacle

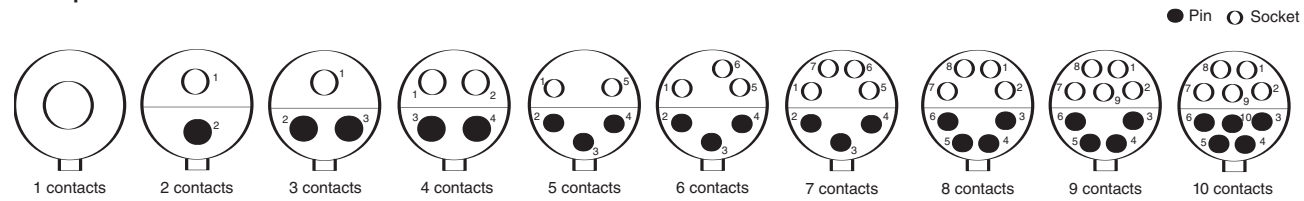

Contact Arrangements

Part Numbers

Receptacle		black	red	green	yellow
No. of contacts	Shell size				
1	SS1R	120-1833-000*			
2	SS2R	120-8551-000	120-8551-010	120-8551-020	120-8551-030
3	SS3R	120-8551-001	120-8551-011	120-8551-021	120-8551-031
4	SS4R	120-8551-002	120-8551-012	120-8551-022	120-8551-032
5	SS5R	120-8551-005	120-8551-015	120-8551-025	120-8551-035
6	SS6R	120-8551-006	120-8551-016	120-8551-026	120-8551-036
7	SS7R	120-8551-007	120-8551-017	120-8551-027	120-8551-037
8	SS8R	120-8551-308			
9	SS9R	120-8551-309			
10	SS10R	120-8551-310			

**) cable entry 2,4 — 3,3 mm Ø (all others 1,8 — 2,8 mm Ø)*

Contacts, stamped with insulation support

	Pins	Sockets	Wire hole fillers
SURE-SEAL 0,5–1,0 mm ²	individual	330-8672-001	031-8703-001
	on reels, 5000 pcs.	SS121348-20	SS121347-20
SURE-SEAL 0,75–1,5 mm ²	individual	330-8672-000	031-8703-000
	on reels, 5000 pcs.	SS121348-10	SS121347-10

Pin Socket Wire hole filler *

* Wire hole fillers are inserted into unused cavities instead of a contact in order to create a watertight sealing.

Contacts, machined without insulation support

	Pins	Sockets	Wire hole
SURE-SEAL 0,5–1,0 mm ²	330-8672-002	031-8703-050	225-0093-000
SURE-SEAL 0,75–1,5 mm ²	330-8672-003	031-8703-051	

Pin Socket Wire hole filler *

* Wire hole fillers are inserted into unused cavities instead of a contact in order to create a watertight sealing.



Dimensions shown in mm
Specifications and dimensions subject to change

www.ittcannon.com

Plug

● Pin ○ Socket

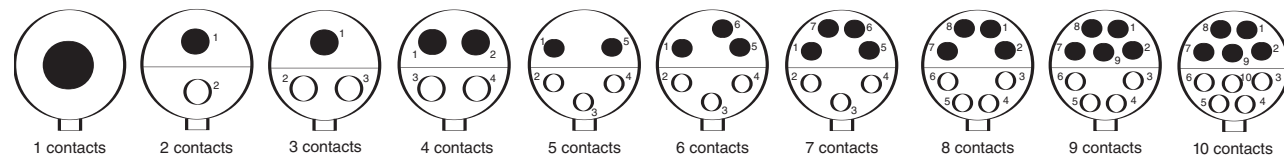

Contact Arrangements

Part Numbers

Plug	Shell size	black	red	green	yellow
1 contacts	SS1P	120-182-000*			
2 contacts	SS2P	120-8552-000	120-8552-010	120-8552-020	120-8552-030
3 contacts	SS3P	120-8552-001	120-8552-011	120-8552-021	120-8552-031
4 contacts	SS4P	120-8552-002	120-8552-012	120-8552-022	120-8552-032
5 contacts	SS5P	120-8552-005	120-8552-015	120-8552-025	120-8552-035
6 contacts	SS6P	120-8552-006	120-8552-016	120-8552-026	120-8552-036
7 contacts	SS7P	120-8552-007	120-8552-017	120-8552-027	120-8552-037
8 contacts	SS8P	120-8552-308			
9 contacts	SS9P	120-8552-309			
10 contacts	SS10P	120-8552-310			

**) cable entry 2,4 — 3,3 mm Ø (all others 1,8 – 2,8 mm Ø)*



Plug with flange	Shell size	black	red	green	yellow
2 contacts	SSF2P	120-8552-200	120-8552-210	120-8552-220	120-8552-230
3 contacts	SSF3P	120-8552-201	120-8552-211	120-8552-221	120-8552-231
4 contacts	SSF4P	120-8552-202	120-8552-212	120-8552-222	120-8552-232
8 contacts	SSF8P	120-8552-305			
9 contacts	SSF9P	120-8552-306			
10 contacts	SSF10P	120-8552-307			



Plug

1 Contact

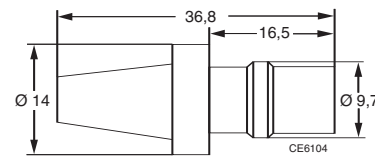

2, 3 and 4 Contacts

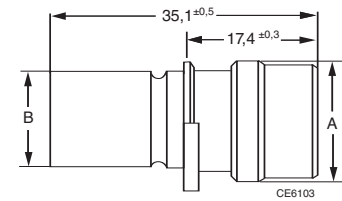

Receptacle

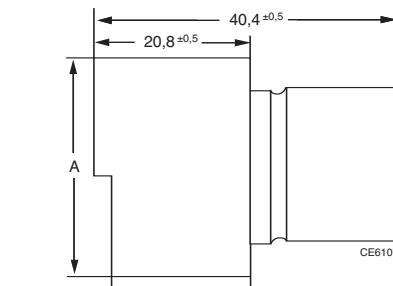
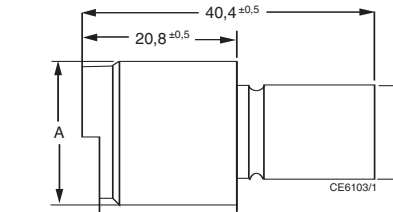
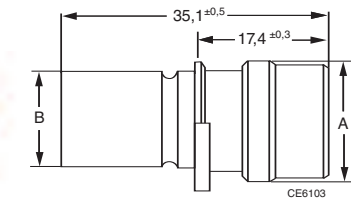
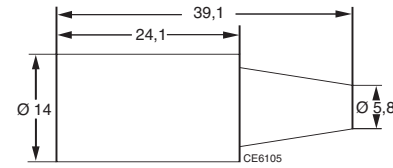

Shell size	Part No.	A - 0,3	B - 0,3	Insulation Ø
SS1P	120-1832-000*			2,4 - 3,3
SS2P	120-8552-000	13,9	10,9	1,8 - 2,8
SS3P	120-8552-001	15,2	12,3	1,8 - 2,8
SS4P	120-8552-002	15,2	12,3	1,8 - 2,8

**) cable entry 2,4 - 3,3 mm Ø (all others 1,8 - 2,8 mm Ø)*

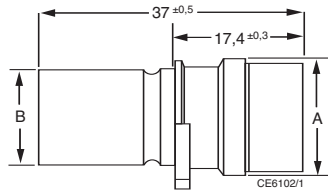

5, 6 and 7 Contacts

Shell size	Part No.	A - 0,3	B - 0,3	Insulation Ø
SS5P	120-8552-005	25,3	20,2	1,8 - 2,8
SS6P	120-8552-006	25,3	20,2	1,8 - 2,8
SS7P	120-8552-007	25,3	20,2	1,8 - 2,8

Shell size	Part No.	A - 0,5	B - 0,3	Insulation Ø
SS1R	120-1833-000*			2,4 - 3,3
SS2R	120-8551-000	18,0	10,9	1,8 - 2,8
SS3R	120-8551-001	18,9	12,3	1,8 - 2,8
SS4R	120-8551-002	18,9	12,3	1,8 - 2,8

Shell size	Part No.	A - 0,3	B - 0,3	Insulation Ø
SS5R	120-8551-005	29,1	20,2	1,8 - 2,8
SS6R	120-8551-006	29,1	20,2	1,8 - 2,8
SS7R	120-8551-007	29,1	20,2	1,8 - 2,8

8 to 10 Contacts

Shell size	Part No.	A ± 0,3	B ± 0,2	Insulation Ø
SS8P	120-8552-308	28,55	23,5	1,8 - 2,8
SS9P	120-8552-309	28,55	23,5	1,8 - 2,8
SS10P	120-8552-310	28,55	23,5	1,8 - 2,8

Shell size	Part No.	A - 0,5	B ± 0,2	Insulation Ø
SS8R	120-8551-308	33,5	23,5	1,8 - 2,8
SS9R	120-8551-309	33,5	23,5	1,8 - 2,8
SS10R	120-8551-310	33,5	23,5	1,8 - 2,8

Plug with flange

2, 3 and 4 Contacts

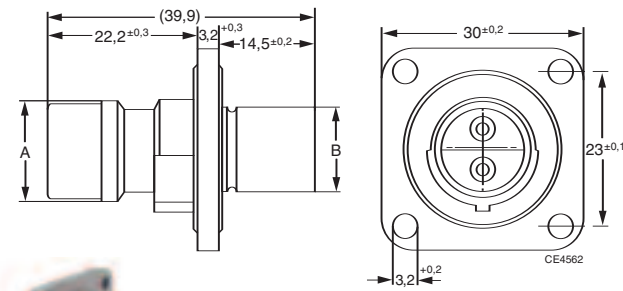

8, 9 and 10 Contacts

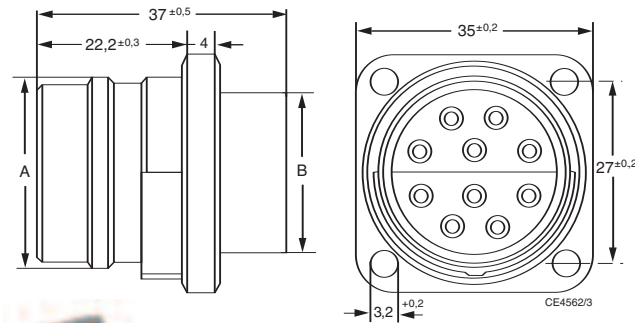

Shell size	Part No.	A - 0,3	B - 0,3	Insulation Ø
SF2P	120-8552-200	13,9	10,8	1,8 - 2,8
SSF3P	120-8552-201	15,2	12,3	1,8 - 2,8
SSF4P	120-8552-202	15,2	12,3	1,8 - 2,8

Shell size	Part No.	A ± 0,3	B ± 0,2	Insulation Ø
SSF8P	120-8552-305	28,55	23,5	1,8 - 2,8
SSF9P	120-8552-306	28,55	23,5	1,8 - 2,8
SSF10P	120-8552-307	28,55	23,5	1,8 - 2,8

Mounting plate

For SURE-SEAL with flange Steel, zinc finish

Mounting Dimensions

Front and rear panel mounting

Order ref 066-8516-002

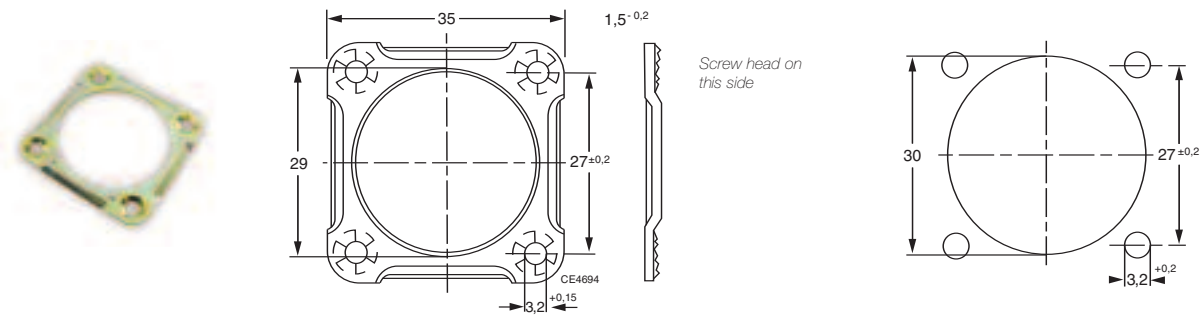

Order ref. 066-8516-000

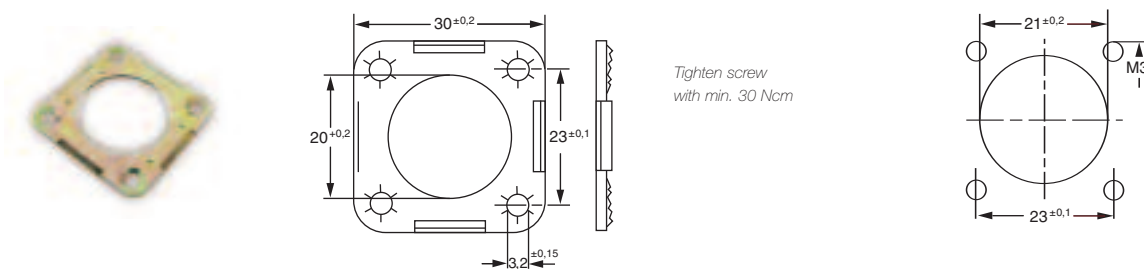

Accessories

Boot

Seals wired cable jackets to connector housing. It also provides abrasion resistance.

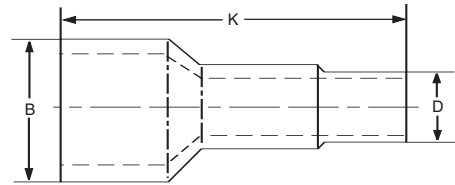

For connector size	Order ref.	B Ø max.	D Ø max.	outer cable Ø	K max.
2 contacts	317-1398-000	16,51	9,65	5,28 – 5,79	52,07
3/4 contacts	317-1397-000	15,49	9,65	5,59 – 6,10	52,07
3/4 contacts	317-1399-000	19,05	12,70	8,76 – 9,65	52,07
5/7 contacts	317-8657-000	27,0	12,50	7,20 – 8,40	62,00
8/9/10 cont.	317-8657-002	31,2	16,2	10 – 12,4	63,7

Grommet

Grommets enable panel mounting of either plugs or receptacle. It snaps into a hole of a panel so non-flanged plugs or receptacles can be mounted.

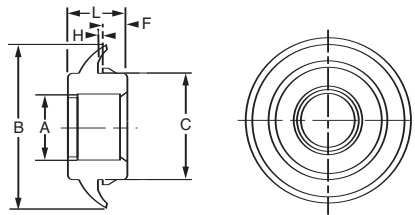

For connector size	Order ref.	A Ø max.	B Ø max.	C Ø max.	F max.	H max.	L max.
2 contacts	315-1640-000	10,41	32,39	19,18	5,84	1,40	17,53
3/4 contacts	315-1641-000	11,94	32,39	19,18	5,84	1,40	17,53
5/6/7 contacts	315-1633-000	19,43	55,88	36,70	8,00	1,65	20,57
8/9/10 cont.	315-1634-000	22,61	55,88	36,70	8,00	1,65	20,57

Wire Fillers

Wire hole fillers are inserted into unused cavities instead of a contact in order to create a watertight sealing.



Wire hole filler
Part Number 225-1012-000

Wire hole filler
Part Number 225-0093-000

Accessories Clip/clamp

Clips/Clamps can be used as an extra lock to secure two connector halves. Due to its design it also offers the possibility for fixed mounting a mated pair by using a screw or a cable tie.

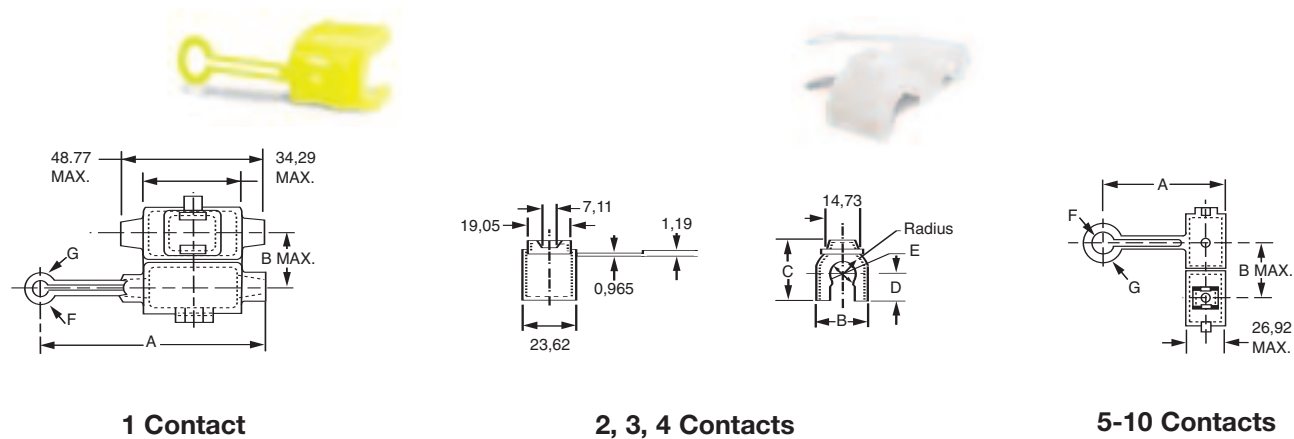
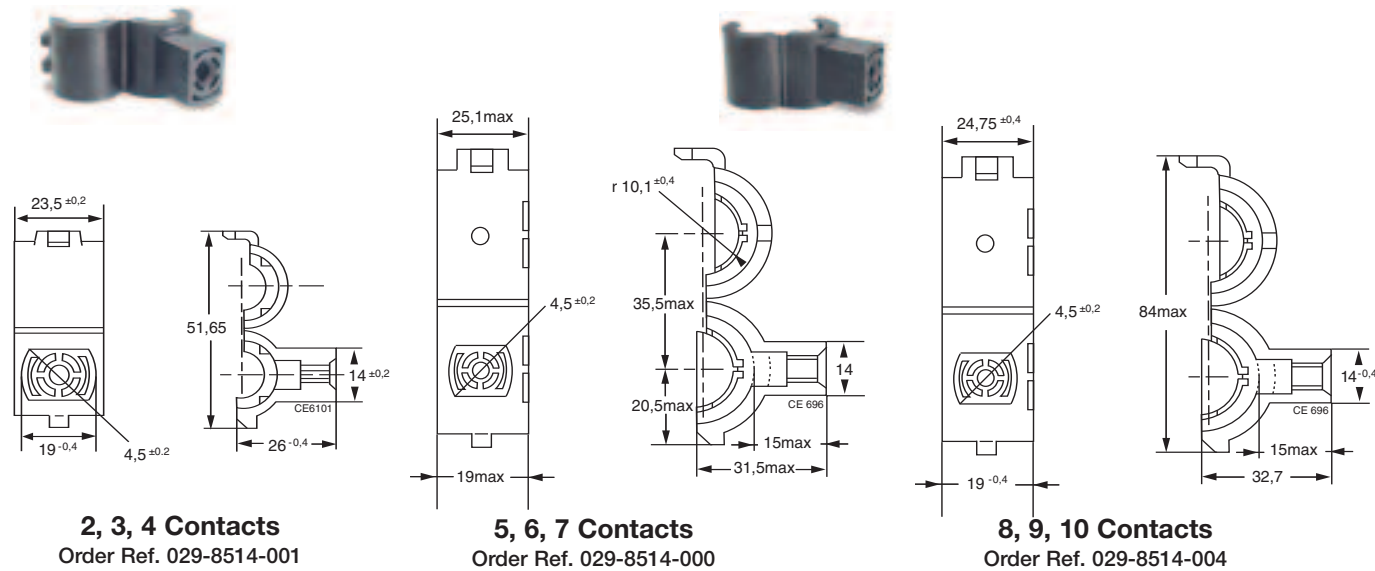

Clip/clamp

Clamps plug and receptacle in mated condition

Connector size	Color of clip/clamp	Order ref.	A max.	B	C	D	E Ø	F max.	G max.
1 contact	Black	026-0452-000	56,52	18,80	-	-	-	5,33	9,91
2 contacts	Red	029-0263-000	-	22,61	25,40	10,67	-	-	-
3/4 contacts	Yellow	029-0262-000	-	23,62	26,67	11,43	12,19	-	-
5/6/7 contacts	Natural	026-0450-000	77,34	35,43	-	-	-	15,49	23,11
8/9/10 contacts	Black	026-0451-000	77,34	38,61	-	-	-	16,76	24,38

Hand Crimp Tool CCT- for stamped contacts



Crimp tool	Contact size	Pin contact	Socket contact	Stripping length mm	Outer wire insulation Ø
CCT-MSS/SS-20	SS-20	330-8672-001	031-8703-001	3,6-3,8	1,8-2,4
CCT-MSS/SS-20	MSS-100	330-8672-100	031-8703-100	3,3-3,6	1,4-1,8
CCT-SS-10	SS-10	330-8672-000	031-8703-000	5,0-5,5	1,8-2,8
CCT-SS-10	SS-10	330-8672-000	031-8703-000	5,0-5,5	2,8-3,3

Instructions

- Strip wire (neither twist nor touch stripped section)



- Insert single contact in correct crimp profile and locate onto wire stop (refer to table for outer insulation diameter).
- Close hand crimp tool until it holds contact in place.
- Insert pre-stripped wire until light contact is made on wire stop, and lay wire into contact barrels.
- Fully close hand crimp tool until ratchet releases.
- Remove contact.
- Inspect crimped area visually.

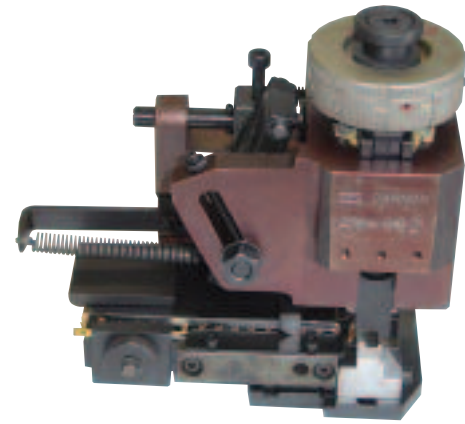

Quick Change Tool 20.100 Mini Applicator

for semi-automatic and automatic crimp machines

Cannon Tool 20.100 can be exchanged easy, quick and effortless. The compact construction as well as the clamping device allow using the tool 20.100 with other crimp machines.

Technical Data

Lift	40 mm
Wire size to be processed	max. 6 mm ²
Installation dimension (lower dead centre)	135.78 +/- 0,02 mm

Contacts

Contacts for the different connector series are available on reels. They can be terminated with the tool on the crimp machine EPS2000 (see table below).

Quick Change Tool	Part Number	Contacts	Contacts per reel	Termination range mm ²
WWZ-20.100-SS10	12156-5137	Sure Seal	5,000	0,75 - 1,5
WWZ-20.100-SS20	12156-5139	Sure Seal	5,000	0,5 - 1,0
WWZ-20.100-MSS	12156-5140	Mini Sure Seal	5,000	0,4 - 0,75

Adjustments for the tools - please refer to the datasheet supplied with the tool.

Hand Crimp Tool M22520-1-01 (Part Number: 995-0001-585)

for machined contacts



Crimp tool	Contacts	Contact Size	Turret	Wire size		Stripping Length mm
				Pin and Socket mm	AWG	
M22520-1-01	330-8672-003 031-8703-051	SS10	CT120090-M4	0,75-1,5		6,5 ^{+0,3}
	330-8672-009 330-8672-002 031-8703-050 031-8703-055	SS20	CT120090-M4	0,5-1,0		6,5 ^{+0,3}
	330-8672-008 031-8703-054	SS	CT120090-M4		12-14	6,5 ^{+0,3}
	330-8672-005 031-8703-052	MSS-100	CT120090-M4	0,4-0,75		5,2 ^{+0,2}

Pneumatic Crimp Tool WA27F-CE

for machined contacts

This tool is designed for 8-indent crimps. For insertion and removal of contact insert please refer to tool description.

Specifications

Air pressure 5.7-6.3 bar
Weight 4 kg

Sequence

- Mount correct contact positioner.
- Adjust tool for correct wire size using reference gauge (refer to table).
- Place contact in correct positioner.
- Insert stripped wire into crimp bore hole of contact.



Order numbers

Crimp tool	Contacts	Contact Size	Positioner	Wire size		Stripping length mm
				Pin and Socket mm ²	AWG	
WA27F-CE	330-8672-003 031-8703-051	SS10	CT120090-M4	0,75-1,5		6,5 ^{+0,3}
	330-8672-009 330-8672-002 031-8703-050 031-8703-055	SS20	CT120090-M4	0,5-1,0		6,5 ^{+0,3}
	330-8672-008 031-8703-054	SS	CT120090-M4		12-14	6,5 ^{+0,3}
	330-8672-005 031-8703-052	MSS-100	CT120090-M4	0,4-0,75		5,2 ^{+0,2}

Semi-Automatic Crimp Machine HACS-5

for machined contacts

Machined contacts can be terminated quickly and efficiently with the Cannon semi-automatic crimp machine HACS-5.

Specifications

Power supply	220 V/Hz
Air pressure	min. 6 bar
Dimensions	600 x 600 mm
Weight	approx. 82 kg

For operating the machine and adjusting the crimp depth please refer to separate operating instructions

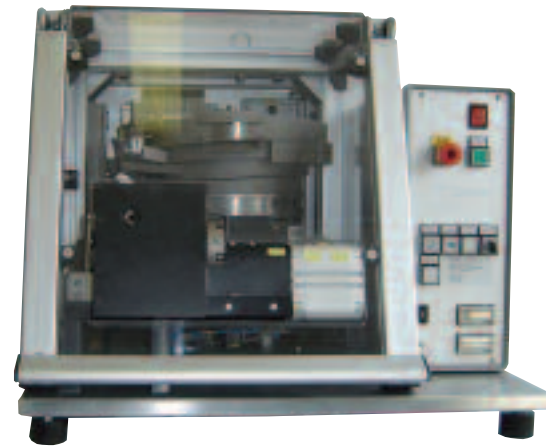

Crimp machine	Contacts	Contact Size	Wire size		Stripping length mm
			Pin and Socket mm ²	AWG	
HACS-5-SS	330-8672-003 031-8703-051	SS10	0,75-1,5		6,5 ^{+0,3}
	330-8672-009 330-8672-002 031-8703-050 031-8703-055	SS20	0,5-1,0		6,5 ^{+0,3}
HACS-5-SS-12/14 *	330-8672-008 031-8703-054	SS		12-14	6,5 ^{+0,3}
HACS-5-MSS *	330-8672-005 031-8703-052	MSS-100	0,4-0,75		5,2 ^{+0,2}

Spare indenter: 7011707

* available by request

Visual Check

for machined contacts

Correct crimp

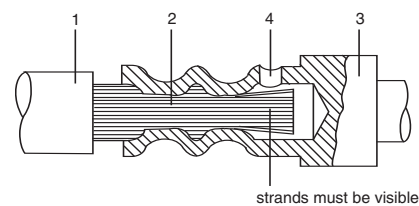

Correct crimp

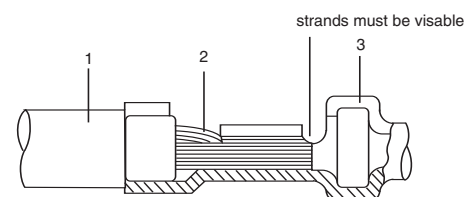

Incorrect crimp

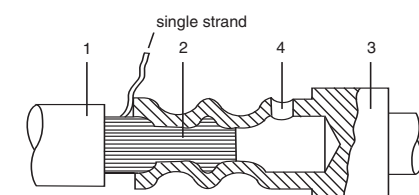

Incorrect crimp

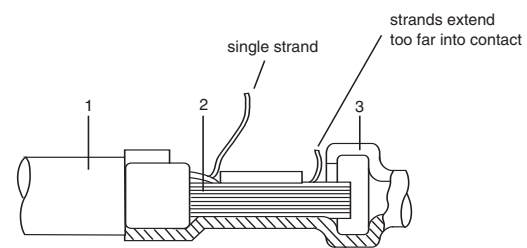

1 insulation 2 strands 3 contact 4 drill bore

Incorrect crimp

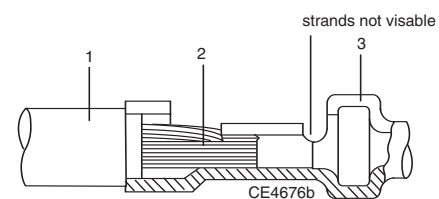

1 insulation 2 strands 3 contact

Tensile strength according to DIN 41611, section 3

Micro sections

Enlargement of micro section allows for final judgement of crimp quality. This test is recommended whenever new tools or new types of wire are used.

Contact Insertion Tools

for machined contacts

Support block for series production

Support block to install contacts in small and medium series. This support block consists of a basic body which can be equipped, according to individual requirements, with exchangeable insert for plugs and receptacles.

Please note: When required exchangeable inserts to be ordered separately.

Support block

For 1 to 4 way SURE-SEAL, SURE-SEAL with flange and Mini SURE-SEAL for 5 to 10 way SURE-SEAL.



No. of contacts	Basic tool to use for SURE-SEAL Standard		Mini SURE-SEAL	Exchangeable inserts to use for SURE-SEAL Standard			Mini SURE-SEAL	
		with flange		Plug	Reference	with flange	Plug	Receptacle
1	CIFG-SS-1			CT195-8508-010	CT195-8508-011			
2	CIFG-SS-2	CIF-SSF-2	CIF-MSS-2	CT195-8508-000	CT195-8508-001	CT195-8508-000	CT195-8508-013	CT195-8508-014
3	CIFG-SS-3	CIF-SSF-3	CIF-MSS-3	CT195-8508-002	CT195-8508-003	CT195-8508-002	CT195-8508-015	CT195-8508-016
4	CIFG-SS-4	CIF-SSF-4	CIF-MSS-4	CT195-8508-004	CT195-8508-005	CT195-8508-004	CT195-8508-017	CT195-8508-018
5/6/7	CIFG-SS-5-6-7	CIF-SSF-5-6-7		CT195-8508-006	CT195-8508-007	CT195-8508-006		
8/9/10	CIFG-SS-8-9-10	CIF-SSF-8-9-10		CT195-8508-008	CT195-8508-009	CT195-8508-008		

Insertion Tool CIT



Hand insertion tool

Type of insulator	Order no.	Outer insulation Ø*
SS 1P + R to SS 10P + R SSF 8, 9, 10P	CITG-SS-1	1,8-2,8
SSF 2, 3, 4P	CIT -SSF-1	1,8-2,8
MSS 2, 3, 4P+R	CIT-MSS-1	1,4-1,8

Handle

Order number: CT204-8501-002



Insertion tip for

Type of insulator	Order no.	Outer insulation Ø*
SS 1P + R to SS 10P + R SSF 8, 9, 10P	CITG-SS-1-TIP	1,8-2,8
SSF 2, 3, 4P	CIT -SSF-1-TIP	1,8-2,8
MSS 2, 3, 4P+R	CIT-MSS-1-TIP	1,4-1,8

Contact holder tip for

Type of insulator	Order no.	Outer insulation Ø*
SS 1P + R to SS 10P + R SSF 8, 9, 10P	CT317-8666-005	1,8-2,8
SSF 2, 3, 4P	CT317-8666-007	1,8-2,8
MSS 2, 3, 4P+R	CT317-8666-002	1,4-1,8

* Outer insulation Ø 2,8-3,3 on request

Guiding pins have to be used for socket contacts. They are not necessary for Mini SURE-SEAL.

Order number: CT317-8588-000

Approved lubricating fluid
Isopropyl alcohol
Cleaning solvent (e.g. HAKU 424, Chem. Fabrik Kluthe,
Heidelberg, W. Germany)

Insertion Press CHPZ-240

A hand actuated insertion press can be used instead of a hand insertion tool. A manual assembly station consists of a press, a support block and a suitable insertion tip (refer to page 20 and 21). The CHPZ press, the required CIF... support block and the insertion tip must be ordered separately.

Basic press: CHPZ-240
 Support block: Refer to page 19
 Insertion tip: Refer to table
 Wire holder (accessory): CT121086-3210

Version A: Single insertion tip, also used for the hand insertion tool
 B: Double insertion tip
 C: Single insertion tip; can be turned twice by 120°
 D: Single insertion tip; can be turned once by 180°



Parts subject to wear

Insertion tip

Type of contact	Order no.	Outer insulation Ø
SS-10	CT317-8666-007	1,8-2,8
SS-20	CT317-8666-007	1,8-2,8
MSS-100	CT317-8666-002	1,4-1,8



No. of contacts	Version A	Version B	Version C	Version D
1	• CIT-SSF-1-TIP			
2	• CIT-SSF-1-TIP ■ CIT-MSS-1-TIP	• CIT-SSF-2-TIP ■ CIT-MSS-2-TIP		
3	• CIT-SSF-1-TIP ■ CIT-MSS-1-TIP		• CIT-SSF-3-TIP ■ CIT-MSS-3-TIP	
4	• CIT-SSF-1-TIP ■ CIT-MSS-1-TIP			• CIT-SSF-4-TIP ■ CIT-MSS-4-TIP
5	• CIT-SSF-1-TIP			
6	• CIT-SSF-1-TIP			
7	• CIT-SSF-1-TIP			
8	• CIT-SSF-1-TIP			
9	• CIT-SSF-1-TIP			
10	• CIT-SSF-1-TIP			

• = Standard SURE-SEAL with flange ■ = Mini SURE-SEAL (MSS)



Extraction Tools CET

Hand extraction tool

Type of insulator	Pin contact	Order no.	Socket contact
SS 1 - 10P + R			
SSF 2, 3, 4P	CET-SS-P		CET-SS-S
SSF 8, 9, 10P			
MSS 2, 3, 4P+R	CET-MSS-P		CET-MSS-S

Handle
Order number: CT204-8501-002

Spare tip

Type of insulator	Pin contact	Order no.	Socket contact
SS 1 - 10P + R			
SSF 2, 3, 4P	CET-SS-P-TIP		CET-SS-S-TIP
SSF 8, 9, 10P			
MSS 2, 3, 4P+R	CET-MSS-P-TIP		CET-MSS-S-TIP

Auxiliary Tools CIEF and CIET

Auxiliary tools for repairs

Device for holding connectors during insertion and extraction of crimped contacts.

No. of contacts	Type of insulator	Order no.
2, 3, 4	SS...P + R SSF...P	CIEF-SS-2-3-4
5, 6, 7	SS...P + R	CIEF-SS-5-6-7
8, 9, 10	SS...P + R SSF...P	CIEF-SS-8-9-10
2, 3, 4	MSS...P + R	CIEF-MSS-2-3-4

Guiding pins can be extracted by using a socket contact which is slightly tilted.

Kit for field repair work and prototype

Kit	No. of contacts	Type of insulator	Order no.
1	2, 3, 4 2, 3, 4	SS...P + R SSF...P	CIET-SS-2-3-4-KIT-10
2	5, 6, 7	SS...P + R	CIET-SS-5-6-7-KIT-10
3*	8, 9, 10 8, 9, 10	SS...P + R SSF...P	CIET-SS-8-9-10-KIT-10
4	2, 3, 4 2, 3, 4	SS...P + R SSF...P	CIET-SS-2-3-4-KIT-20
5	5, 6, 7	SS...P + R	CIET-SS-5-6-7-KIT-20
6*	8, 9, 10 8, 9, 10	SS...P + R SSF...P	CIET-SS-8-9-10-KIT-20
7	2, 3, 4	SS...P + R	CIET-MSS-2-3-4-KIT

* upon request



Contents

- 1 Operating instruction
- 1 CIEF Insertion and extraction holder
- 1 CIT Insertion tool
- 1 CET Extraction tool (socket contacts)
- 1 CET Extraction tool (pin contacts)
- 1 CCT Crimp tool

Lubricating fluid: Isopropyl alcohol
10 Guiding pins (not included for MSS)

No. of contacts	Assembly machine
2	CBITA-SS-2
3	CBITA-SS-3
4	CBITA-SS-4
5	CBITA-SS-5
6	CBITA-SS-6
7	CBITA-SS-7
8	CBITA-SS-8
9	CBITA-SS-9
10	CBITA-SS-10

Parts subject to wear:

Guiding pin-Sensor release	CT121-586-229
Guiding pin-Foot pedal release	CT970-8606-022
Widening tip	CT252-7015-003

Semi-Automatic Assembly Machine CBITA

for 2 to 10 way SURE-SEAL connectors
for Mini SURE-SEAL contacts by request

Technical Data

Air pressure	min. 6 bar
Weight	approx. 60 kg
Power supply	220 V/50Hz



Wiring Instructions

Note: Insert accessories (e. g. Boot) prior to assembly.

Stripping lengths

For jacketed cables the following stripping lengths have to be adhered to.

No. of contacts	min. stripping lengths mm
2, 3, 4	40
5, 6, 7	45
8, 9, 10	50

Insertion contacts

SURE-SEAL connectors have a one-piece connector body made of rubber. Contacts are inserted from the rear side. They may only be inserted with the approved tools (refer to page 18-22).

Plug or receptacle must be sprayed with lubricating fluid before contact insertion.

Approved lubricating fluid

Manual insertion

Isopropyl alcohol
Cleaning solvent HAKU 424, Chem. Fabrik Kluthe
Gottlieb-Daimier Straße 12, 6900 Heidelberg

Semi-automatic insertion

CBITG...and CBITS-...Hellerine (P. Hellermann, Siemensstr. 5, 2080 Pinneberg) for sprayer.

With hand insertion tools

Fasten supports (table, vice etc.)

An inclined position is recommended for easier assembly.

- Dip insulator in lubricating fluid and shake off excess fluid.
- Open fixing clip and place connector body into support block (refer to page 19).
- Insert cable resp. single wires into accessories (e. g. boot).
- Pay attention to correct sequence and position
- Install guiding pin CT317-8588-000 (does not apply to Mini SURE-SEAL) in socket contact.

- Place contact in hand insertion tool. The contact shoulder has to touch the front side of the contact tip.

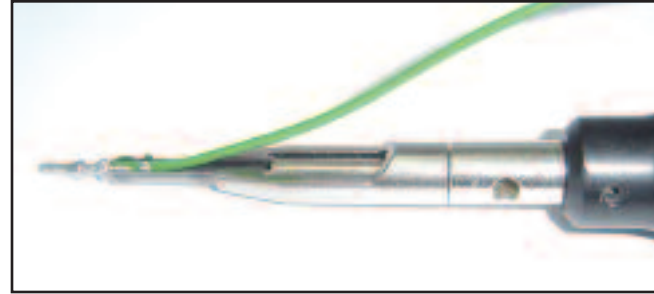

- Insert contact into the connector until it snaps in by applying constant pressure. Note: Make sure that the contact and tool are inserted parallel to the insulator axis. Do not tilt!

Note: Socket or pin contacts have to be inserted into the correct contact cavity.

- Remove guiding pins from the socket contacts!
- Mount accessories.
- Remove the terminated connector from support after insertion of all contacts and check correct fit and position of the contacts in the insulator (refer to page 18).

Usage of jacketed cable with boot

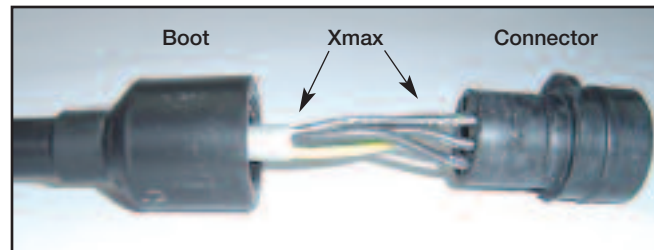

No. of contacts	X max.
2, 3, 4	22
5, 6, 7	26

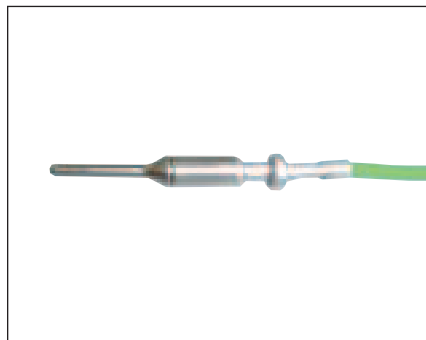

Wiring Instructions

With CHPZ-240 hand lever insertion press

Mount correct support block and insertion tip to CHPZ-240 insertion press (refer to page 21).

- Dip connector body into lubricating fluid and shake off excess fluid. Open fixing clip and place connector body in support block (refer to page 18 and 19).
- Insert wire into accessories. Pay attention to correct sequence and position (refer to illustration page 24).
- Insert guiding pins CT317-8588-000 (only for Standard SURE-SEAL) into socket contacts (refer to illustration page 24).
- Place contact into insertion tip. Contact shoulder has to be flush with lower edge of the contact tip.

- Adjust height of hand lever press: For first insertion loosen stop at the upper end of the press. Move down lever slowly and steadily and adjust stop until contact is in the correct position (refer to page 21). Tighten stop. This adjustment may be used for both socket and pin contacts. After this adjustment the lever is simply pressed until stop is reached. Remove terminated connector from support after all contacts are inserted.

- Check fit and position of contacts in insulator.
- Remove guiding pins from socket contacts.
- Assemble accessories.

For Assembly Machines CBITG and CBITS
refer to separate operating instructions

Standard SURE-SEAL

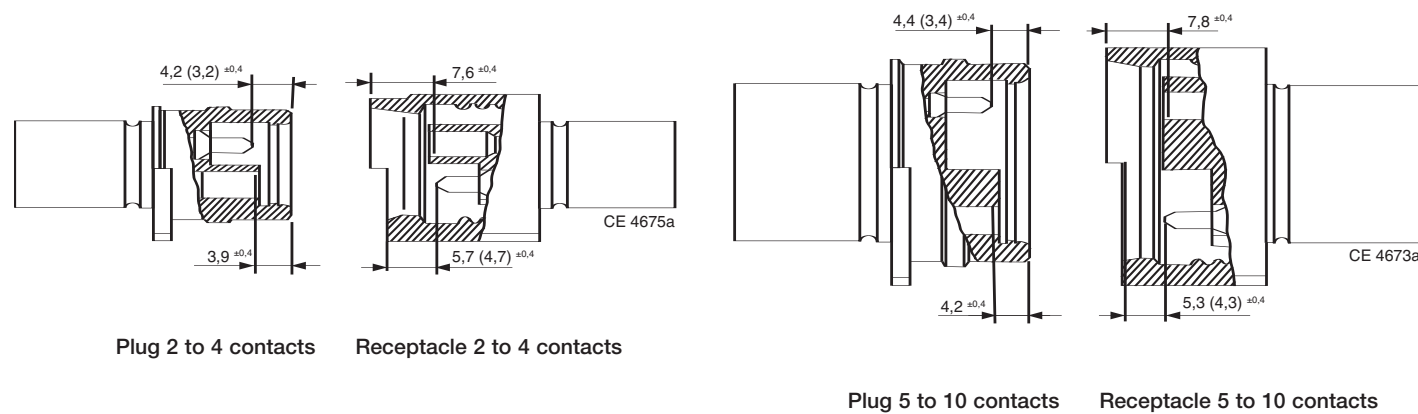

Different dimensions for machined contacts are given in paranthesis.

Mini SURE-SEAL

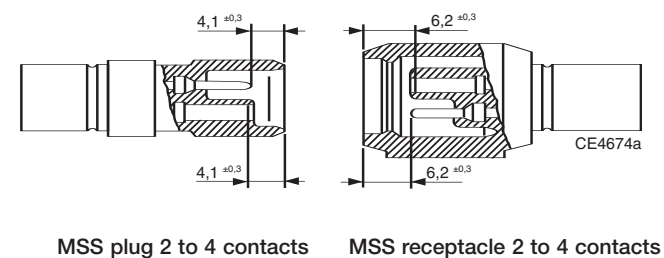

Product Safety Information

THIS NOTE MUST BE READ IN CONJUNCTION WITH THE PRODUCT DATA SHEET/CATALOG. FAILURE TO OBSERVE THE ADVICE IN THIS INFORMATION SHEET AND THE OPERATING CONDITIONS SPECIFIED IN THE PRODUCT DATA SHEET/ CATALOG COULD RESULT IN HAZARDOUS SITUATIONS.

1. MATERIAL CONTENT AND PHYSICAL FORM

Electrical connectors do not usually contain hazardous materials. They contain conducting and non-conducting materials and can be divided into two groups.

a) Printed circuit types and low cost audio types which employ all plastic insulators and casings.

b) Rugged, Fire Barrier and High Reliability types with metal casings and either natural rubber, synthetic rubber, plastic or glass insulating materials. Contact materials vary with type of connector and also application and are usually manufactured from either: Copper, copper alloys, nickel, alumel, chromel or steel. In special applications, other alloys may be specified.

2. FIRE CHARACTERISTICS AND ELECTRIC SHOCK HAZARD

There is no fire hazard when the connector is correctly wired and used within the specified parameters. Incorrect wiring or assembly of the connector or careless use of metal tools or conductive fluids, or transit damage to any of the component parts may cause electric shock or burns. Live circuits must not be broken by separating mated connectors as this may cause arcing, ionization and burning. Heat dissipation is greater at maximum resistance in a circuit. Hot spots may occur when resistance is raised locally by damage, e.g. cracked or deformed contacts, broken strands of wire. Local overheating may also result from the use of the incorrect application tools or from poor quality soldering or slack screw terminals. Overheating may occur if the ratings in the product Data Sheet/Catalog are exceeded and can cause breakdown of insulation and hence electric shock. If heating is allowed to continue it intensifies by further increasing the local resistance through loss of temper of spring contacts, formation of oxide film on contacts and wires and leakage currents through carbonization of insulation and tracking paths. Fire can then result in the presence of combustible materials and this may release noxious fumes. Overheating may not be visually apparent. Burns may result from touching overheated components.

3. HANDLING

Care must be taken to avoid damage to any component parts of electrical connectors during installation and use. Although there are normally no sharp edges, care must be taken when handling certain components to avoid injury to fingers. Electrical connectors may be damaged in transit to the customers, and damage may result in creation of hazards. Products should therefore be examined prior to installation/use and rejected if found to be damaged.

4. DISPOSAL

Incineration of certain materials may release noxious or even toxic fumes.

5. APPLICATION

Connectors with exposed contacts should not be selected for use on the current supply side of an electrical circuit, because an electric shock could result from touching exposed contacts on an unmated connector. Voltages in excess of 30 V ac or 42.5 V dc are potentially hazardous and care should be taken to ensure that such voltages cannot be transmitted in any way to exposed metal parts of the connector body. The connector and wiring should be checked, before making live, to have no damage to metal parts or insulators, no solder blobs, loose strands, conducting lubricants, swarf, or any other undesired conducting particles. Circuit resistance and continuity check should be made to make certain that there are no high resistance joints or spurious conducting paths. Always use the correct application tools as specified in the Data Sheet/Catalog. Do not permit untrained personnel to wire, assemble or tamper with connectors. For operation voltage please see appropriate national regulations.

IMPORTANT GENERAL INFORMATION

(i) Air and creepage paths/Operating voltage. The admissible operating voltages depend on the individual applications and the valid national and other applicable safety regulations.

For this reason the air and creepage path data are only reference values. Observe reduction of air and creepage paths due to PC board and/or harnessing.

(ii) Temperature

All information given are temperature limits. The operation temperature depends on the individual application.

(iii) Other important information

Cannon continuously endeavors to improve their products. Therefore, Cannon products may deviate from the description, technical data and shape as shown in this catalog and data sheets.

“Engineered for life” is a registered trademark of ITT Industries, ©2006. All other trademarks or registered trademarks are property of their respective owners. All data subject to change without notice.

Product Warranty

ITT Cannon, a Division of ITT Industries, Inc. manufactures the highest quality products available in the marketplace; however these products are intended to be used in accordance with the specifications in this publication. Any use or application that deviates from the stated operating specifications is not recommended and may be unsafe. No information and data contained in this publication shall be construed to create any liability on the part of Cannon. Any new issue of this publication shall automatically invalidate and supersede any and all previous issues. A limited warranty applies to Cannon products. Except for obligations assumed by Cannon under this warranty, Cannon shall not be liable for any loss, damage, cost of repairs, incidental or consequential damages of any kind, whether or not based on express or implied warranty, contract, negligence or strict liability arising in connection with the design, manufacture, sale, use or repair of the products. Product availability, prices and delivery dates are exclusively subject to our respective order confirmation form; the same applies to orders based on development samples delivered. This publication is not to be construed as an offer. It is intended merely as an invitation to make an offer. By this publication, Cannon does not assume responsibility or any liability for any patent infringements or other rights of third parties which may result from its use. Reprinting this publication is generally permitted, indicating the source. However, Cannon's prior consent must be obtained in all cases.



Electronic Components

Connector Product Locations

GERMANY
Cannonstrasse 1
Weinstadt, 71384
phone: 49.7151.699.0
fax: 49.7151.699.217

HONG KONG
Unit 901 & 912, West Tower
Shun Tak Center
168-200 Connaught Road
Central
phone: 852.2732.2720
fax: 852.2732.2919

ITALY
Via Pietro Panzeri 10
Milano, 20123
phone: 39.2.58180.1
fax: 39.2.8372036

UK
Jays Close, Viabes Estate
Basingstoke, RG22 4BA
phone: 44.1256.311200
fax: 44.1256.323356

USA
666 East Dyer Road
Santa Ana, CA 92705
toll free: 1.800.854.3028
phone: 1.714.557.4700
fax: 1.714.628.2142

SURE-SEAL Connectors

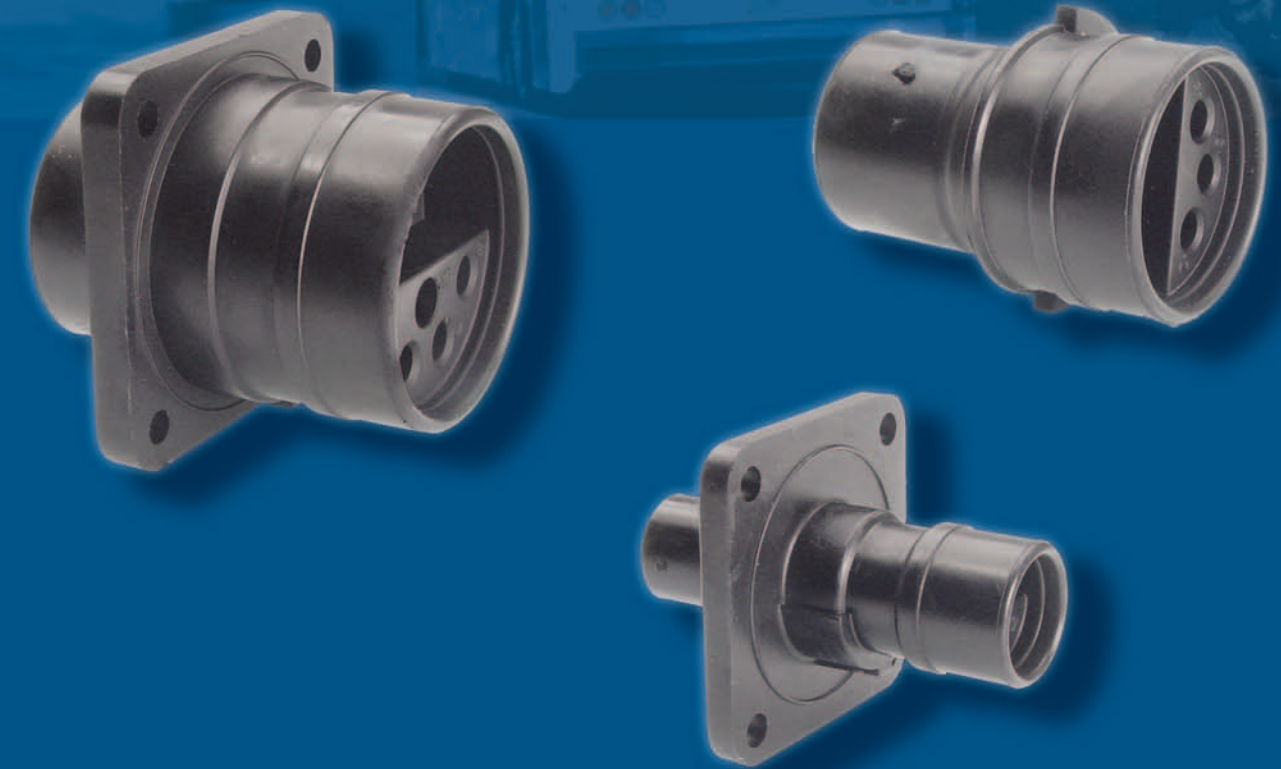

"Engineered for life" is a registered trademark
of ITT Industries. ©2006. All data subject to change
without notice.

Sure-Seal 06-Mar

www.ittcannon.com

Engineered for life

X-ON Electronics

Largest Supplier of Electrical and Electronic Components

Click to view similar products for [Socket Junction Modules](#) category:

Click to view products by [ITT](#) manufacturer:

Other Similar products are found below :

[00610700081](#) [120-1833-000](#) [SJG016100](#) [SJG022171](#) [SJG022200](#) [SJM020601](#) [SJM022101](#) [107890-ZZ](#) [SJG020200](#) [SJM022501](#) [SJG020170](#)
[M81714/61-0Z](#) [SJG022271](#) [SJM022701](#) [BTJ116E02B-513](#) [BTJ120E02C-513](#) [SJM020301](#) [SJM022601](#) [SJG016270](#) [SJG020271](#)
[00175110600](#) [BTL-16-513](#) [00111510102](#) [BTM-16](#) [SJM000800](#) [BTM-22-513](#) [BTL-16](#) [00175110200](#) [00170511156](#) [00175110800](#)
[00175110700](#) [BTM-22](#) [00175110107](#) [SJE020016](#) [00175110507](#) [00111510502](#) [00175110300](#) [00111510202](#) [00175110207](#) [00175110400](#)
[SJM012200](#) [SJM022201](#) [SJE020045](#) [SJM016101](#) [SJM016201](#) [SJM020101](#) [A85049124S25W](#) [A85049124S13W](#) [A85049124S17W](#)
[A85049124S11W](#)