



## APD / DIN 72585 Connectors



Cannon



**ITT Industries**  
*Engineered for life*

# APD / DIN 72585 Connector

<b>Contents</b>	
<b>Introduction</b>	2
<b>Features</b>	2
<b>Benefits</b>	2
<b>Connector 4-way</b>	
- Technical Data 4-way	3
- Plug Housing 4-way	4
- Flange Receptacle 4-way	5
- Jam Nut Receptacle 4-way	6
- Contacts, Seals 4-way	7
- Tooling 4-way	8
<b>Connectors 6-/7-way</b>	
- Technical Data 6-/7-way	9
- Plug 6-/7-way	10
- Flange Receptacle 6-/7-way; standard crimp contact press-in contact	11
- Jam Nut Receptacle 6-/7-way; standard crimp contact press-in contact	12
- Contacts, Seals, 6-/7-way	13
- Tooling 6-/7-way	14
<b>High Power Connector 1-way</b>	
- Technical Data High Power 1-way	15
- High Power Plug 1 - way	16
- High Power Flange Receptacle 1-way	17
- High Power Jam Nut Receptacle 1-way	18
- High Power 1-way, Contacts	19
- High Power 1-way, Contacts, Seals,	20
- Tooling High Power 1-way	21
<b>High Power Connector 2-way</b>	
- Technical Data High Power 2-way	23
- High Power Plug 2-way	24
- High Power Flange Receptacle 2-way	25
- High Power Jam Nut Receptacle 2-way	26
- Tooling High Power 2-way	27
- High Power 2-way, Contacts, Seals,	28
<b>Custom made versions</b>	22
<b>Accessories</b>	29
<b>Conversion Chart</b>	31
<b>Product Safety Information</b>	32

## Benefits

- Meets sensors and actuators requirements
- Signal integrity for low current applications
- Survives harshest vehicle environment
- Superior environmental sealing
- Easy contact assembly and installation into connector housing
- Easy contact assembly and installation into connector housing
- Enhanced durability during assembly
- Low installed cost

## Introduction

### Connectors with Bayonet Coupling Heavy Duty Environmental

- Cable connector
- Receptacle with flange for front and rear mounting
- Jam nut receptacle
- High Power connector
- Customer tailored versions (please consult factory)

APD is a direct, in-line and bulkhead sensor connector that is resistant to engine, transmission and brake fluid. It also boasts very low contact resistance, so you can benefit from maximum signal integrity. APD is available in 1-, 2-, 3-, 4-, 6- and 7 position versions and has been designed to meet all DIN 72585 requirements.

### Applications for the 4- and 7-way connector

- Sensors
- Traction / Anti Skid Control
- Brake Control (ABS)
- Magnetic Switch Control Systems
- Valve Control ( Water, Oil, Air, Pressure)
- Lightening systems on Trucks and Trailers

### Applications for the 1- and 2-way connector

- Power supply
- Power distribution
- Battery links

## Features

- Available with 2, 3 and 4 contacts, current rating 30 A max. (4 mm<sup>2</sup> wire)
- 6 and 7 contacts, current rating 16 A max. (1,5 mm<sup>2</sup> wire)
- 2-way High Power, up to 74 A max. (16 mm<sup>2</sup> wire)
- 1-way High Power up to 245 A max. (50 mm<sup>2</sup> wire)
- Low contact resistance
- High performance engineered materials for continuous operation at - 40°C / 125°C.
- Class K2: -40°C/140°C contact temperature for APD 4-Way and 7-Way
- Environmental sealed to IP 69K
- Individual wire seals
- Hexagonal crimp profile at machined contacts
- Hand insertable contacts
- Bayonet coupling
- Keying  
4 different keying colors (2-, 3-, 4-way)  
1 coding only (7-way and 2-way High Power)  
2 coding possibility 2 different colors  
1 way High Power
- Conduit flex tube termination with straight or 90° right angle endbells
- In acc. to GGVS Resp. ADR

**Specials available  
by request**

## APD / DIN 72585 Connector

<b>APD / DIN 72585</b>						
Series	4-way	4-way	4-way	6-/7-way	6-/7-way	6-/7-way
Type	Plug	Flange Receptacle	Jam Nut Receptacle	Plug	Flange Receptacle	Jam Nut Receptacle
Max. current	21 A 29 A 34 A	21 A 29 A 34 A	21 A 29 A 34 A	12 A 19 A	12 A 19 A	12 A 19 A
Contact Resistance	≤ 5 mΩ	≤ 5 mΩ	≤ 5 mΩ	≤ 5 mΩ	≤ 5 mΩ	≤ 5 mΩ
Contacts	Copper alloy tinned	Copper alloy tinned	Copper alloy tinned	Copper alloy tinned	Copper alloy tinned	Copper alloy tinned
Sealed Cap	-	121583-0021	121583-0021	-	121583-0021	121583-0021
Straight End Bell for Flex Tube	ø 8,5 mm 058-8578-100	-	-	ø 8,5 mm 058-8578-100	-	-
	ø 10 mm 058-8578-102	-	-	ø 10 mm 058-8578-102	-	-
90° End Bell for Flex Tube	ø 8,5 mm 058-8578-101	-	-	ø 8,5 mm 058-8578-101	-	-
	ø 10 mm 058-8578-103	-	-	ø 10 mm 058-8578-103	-	-
Dust Cap	025-8636-005	025-0480-000	025-0480-000	025-8636-005	025-0480-000	025-0480-000
Wire Filler	273-8506-007	273-8506-007	273-8506-007	273-8506-011	273-8506-011	273-8506-011
Page Number	3	5	6	10	11	12

<b>APD / DIN 72585</b>						
Series	High Power 1-way	High Power 1-way	High Power 1-way	High Power 2-way	High Power 2-way	High Power 2-way
Type	Plug	Flange Receptacle	Jam Nut Receptacle	Plug	Flange Receptacle	Jam Nut Receptacle
Max. current	245 A	245 A	245 A	74 A	74 A	74 A
Contact Resistance	≤ 0,4 mΩ	≤ 0,4 mΩ	≤ 0,4 mΩ	≤ 2 mΩ	≤ 2 mΩ	≤ 2 mΩ
Contacts	Copper alloy silver plated	Copper alloy silver plated	Copper alloy silver plated	Copper alloy silver plated	Copper alloy silver plated	Copper alloy silver plated
Sealed Cap	-	121583-0021	121583-0021	-	121583-0021	121583-0021
Flex Tube Adapter ø 21 mm	980-8672-010	-	-	980-8672-010	-	-
90° End Bell (up to 25 mm wire)	980-8672-004	-	-	-	-	-
Dust Cap	025-8636-005	025-0480-000	025-0480-000	025-8636-005	025-0480-000	025-0480-000
Hexagonal Nut	217-8516-010	217-8516-010	217-8516-010	217-8516-010	217-8516-010	217-8516-010
Page Number	16	17	18	24	25	26

Electrical Data		
Voltage	48 VDC max.	
Current	21 A max. for wire size 1,5 mm <sup>2</sup> / 25°C	
	29 A max. for wire size 2,5 mm <sup>2</sup> / 25°C	
	34 A max. for wire size 4,0 mm <sup>2</sup> / 25°C	
Contact resistance	≤ 5mΩ	
Test Voltage	1000 VAC (Ueff)	
Insulation resistance	≥10MΩ	

Mechanical Data		
Sealing acc. to IEC 529 and DIN 40050, Part 9	IP 67 and IP 69K	
Operating Temperature Range	-40°C / 125°C	
	Class K2: -40°C / 140°C contact temperature	
Shock / Vibration	30g acc. to DIN 72585	
Durability	50 Mating cycles	

Materials		
Connector housing	PBT	
O-ring	HNBR	
Contacts	Copper alloy, tinned	
Coupling nut	PA	

Standards and Specifications (in accordance with DIN 72585) Environmental		
DIN 40050, Part 9	Sealing	
DIN 50016	Humidity	
DIN 50021	Resistance against fluids, Salt spray test	
DIN 51512	Lubricants such as engine oil, grease, etc.	
DIN EN 590	Diesel fuel, gasoline	
DIN ISO 4925	Brake fluids, anti-freeze, coolants	

Plug, 4-way

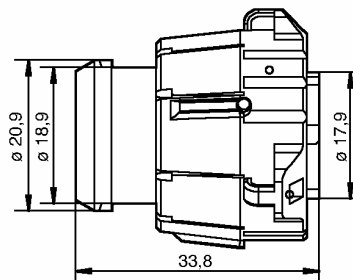
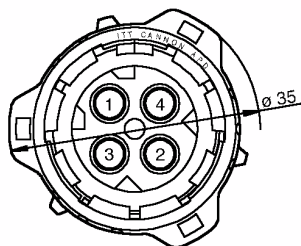

Order No.	Designation	Code	Color
121583-0000	APD-1BS-K2	1	black (RAL 9005)
121583-0001	APD-2BS-K2	2	gray (RAL 7036)
121583-0002	APD-3BS-K2	3	green (RAL 6029)
121583-0003	APD-4BS-K2	4	blue (RAL 5012)

Packaging unit 100 pcs.

Coding, 4-way layouts

View on Mating Face

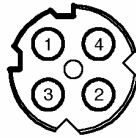

code 1  
black

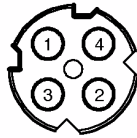

code 2  
gray

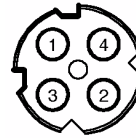

code 3  
green

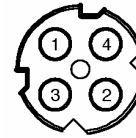

code 4  
blue

Note: The connectors offer both mechanical keying and visual coding by different colors

Socket Crimp Contacts, Individual wire-seal, Wire filler, see page 7

Derating Curve

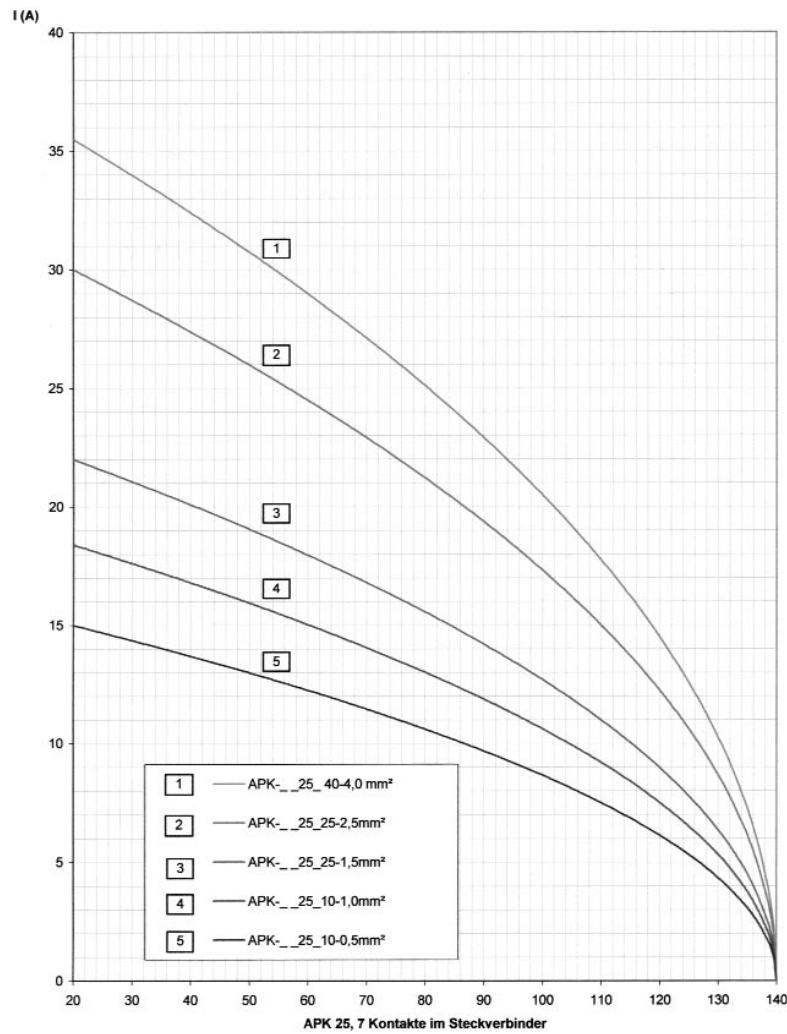

Flange Receptacle, 4-way

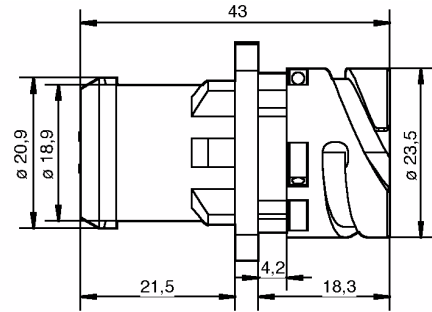
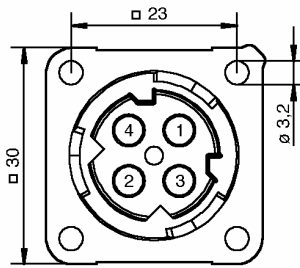

Order No.	Designation	Code	Color
121583-0004	APD-1AP-K2	1	black (RAL 9005)
121583-0005	APD-2AP-K2	2	gray (RAL 7036)
121583-0006	APD-3AP-K2	3	green (RAL 6029)
121583-0007	APD-4AP-K2	4	blue (RAL 5012)

Packaging unit 100 pcs.

Coding, 4-way layouts

View on Mating Face

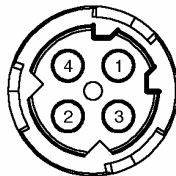

code 1  
black

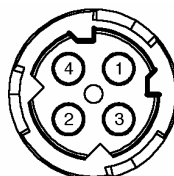

code 2  
gray

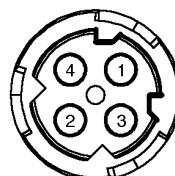

code 3  
green

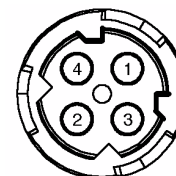

code 4  
blue

Note: The connectors offer both mechanical keying and visual coding by different colors

Panel Cut Out

Flange for all Flange Receptacles

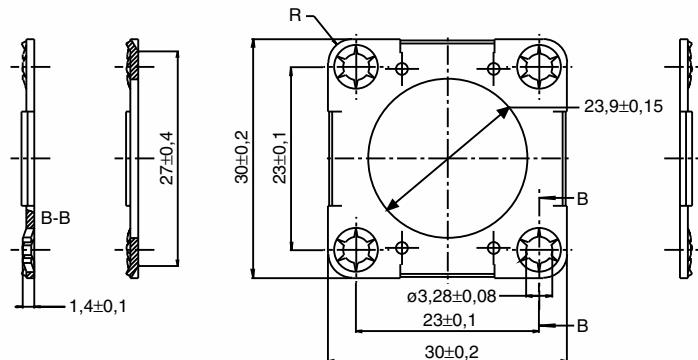
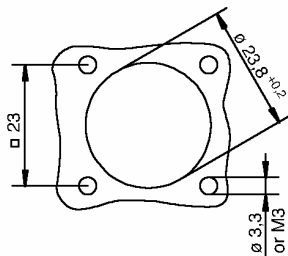

Order Number: 066-8516-005

Pin Crimp-Contacts, Individual wire-seal, Wire filler, Flange gasket, see page 7

Jam Nut Receptacle, 4-way

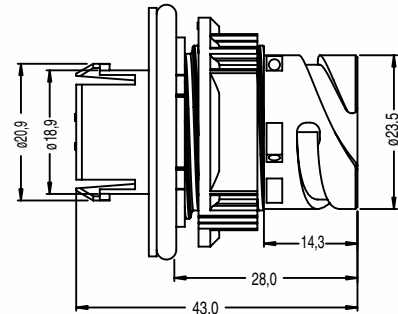
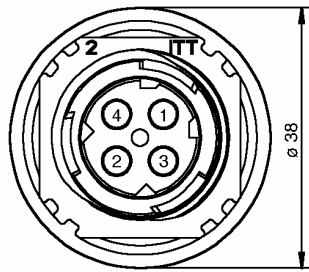

Order No.	Designation	Code	Color
121583-0008	APD-1CP-K2	1	black (RAL 9005)
121583-0009	APD-2CP-K2	2	gray (RAL 7036)
121583-0010	APD-3CP-K2	3	green (RAL 6029)
121583-0011	APD-4CP-K2	4	blue (RAL 5012)

Packaging unit 100 pcs.

Coding, 4-way layouts

View on Mating Face

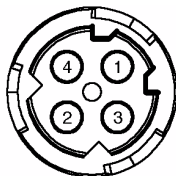

code 1  
black

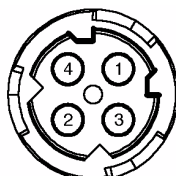

code 2  
gray

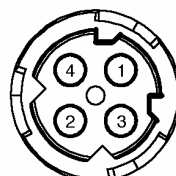

code 3  
green

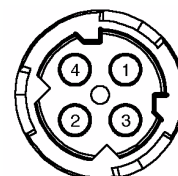

code 4  
blue

Note: The connectors offer both mechanical keying and visual coding by different colors

Panel Cut Out

Piece Parts / Assembly Instruction

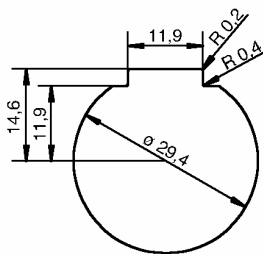

Pin Crimp-Contacts, Individual wire-seal, Wire filler, Flange gasket, see page 7

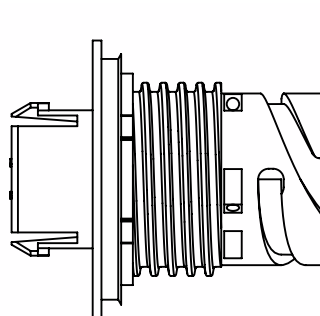

Housing



O-ring



Wall Thickness

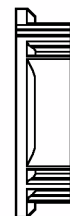

Jam Nut

Standard: min. 1,0 / max. 4,0 mm  
Special: min. 2,0 / max. 5,0 mm

**Socket Crimp-Contacts Standard Tinned, 3000 contacts per reel**

Designation - Standard	Order No.
APK-SB25A10-002 (0,5 - 1,5 mm <sup>2</sup> )	121668-0125
APK-SB25A25-002 (1,5 - 2,5 mm <sup>2</sup> )	121668-0126
APK-SB25A40-002 (2,5 - 4,0 mm <sup>2</sup> )	121668-0127

Optional with Au-flash	
* APK-SB25H10-002 (0,5 - 1,5 mm <sup>2</sup> )	121668-0022
* APK-SB25H25-002 (1,5 - 2,5 mm <sup>2</sup> )	121668-0128
* APK-SB25H40-002 (2,5 - 4,0 mm <sup>2</sup> )	121668-0124
* Available only by request	

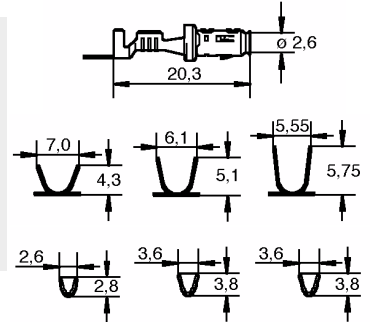

**Pin Crimp-Contacts Standard Tinned, 3000 contacts per reel**

Designation - Standard	Order No.
APK-PB25A10-002 (0,5 - 1,5 mm <sup>2</sup> )	121668-0026
APK-PB25A25-002 (1,5 - 2,5 mm <sup>2</sup> )	121668-0027
APK-PB25A40-002 (2,5 - 4,0 mm <sup>2</sup> )	121668-0028

Optional with Au-flash	
* APK-PB25H10-002 (0,5 - 1,5 mm <sup>2</sup> )	121668-0024
* APK-PB25H25-002 (1,5 - 2,5 mm <sup>2</sup> )	121668-0029
* APK-PB25H40-002 (2,5 - 4,0 mm <sup>2</sup> )	121668-0020
* Available only by request	

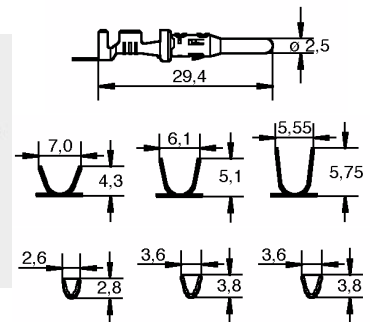

**Individual Wire Seals**

**For all versions 4-way**

Designation	Order No.
10RD5821	273-8506-005
Wire insulation $\varnothing$ 1,4 - 2,0 mm / red	
15BL5822	273-8506-006
Wire insulation $\varnothing$ 2,0 - 2,9 mm / blue	

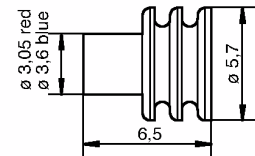

**Wire Filler**

**For all versions 4-way**

Designation	Order No.
15WH5823	273-8506-007
white	

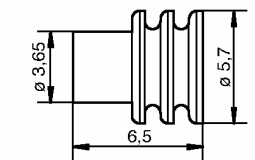

**Flange Gasket**

**For Flange Receptacle, 4-way**

Order No.	
075-8503-000 (-55/125° C)	
075-8503-004 (-30/200° C)	
Packaging unit 100 pcs.	

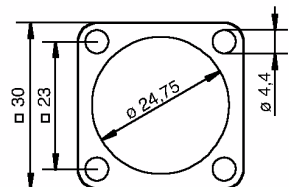

**Jam Nut, special**

Designation	Order No.
for special wall thickness 1,0 - 4,0 mm	217-8516-002



**Crimp and Assembly Tools for APK 25 Contacts**

Contact / Socket	Hand Crimp Tool / Order No.	Crimp-Dies
APK-SB25A10-002 (0,5 - 1,0 mm <sup>2</sup> )	M22520-5-01 / 995-0001-761	CT121586-289
APK-SB25A25-002 (1,5 - 2,5 mm <sup>2</sup> )	M22520-5-01 / 995-0001-761	CT121586-290
APK-SB25A40-002 (2,5 - 4,0 mm <sup>2</sup> )	M22520-5-01 / 995-0001-761	CT121586-292

Contact / Pin	Hand Crimp Tool / Order No.	Crimp-Dies
APK-PB25A10-002 (0,5 - 1,0 mm <sup>2</sup> )	M22520-5-01 / 995-0001-761	CT121586-289
APK-PB25A25-002 (1,5 - 2,5 mm <sup>2</sup> )	M22520-5-01 / 995-0001-761	CT121586-290
APK-PB25A40-002 (2,5 - 4,0 mm <sup>2</sup> )	M22520-5-01 / 995-0001-761	CT121586-292

**Crimp Machine for volume production**



Designation	Order No.
EPS 2000	121586-5039

**Quick Change Tool for above Crimp Machine: (Mini Applicator)**



Contact / Socket	Designation	Order No. (to be mentioned on order)
APK-SB25A10-002 (0,5 - 1,0 mm <sup>2</sup> )	WWZ.20-100-APK25-10-002	121586-5134
APK-SB25A25-002 (1,5 - 2,5 mm <sup>2</sup> )	WWZ.20-100-APK25-25-002	121586-5135
APK-SB25A40-002 (2,5 - 4,0 mm <sup>2</sup> )	WWZ.20-100-APK25-40-002	121586-5136

Contact / Pin	Designation	Order No. (to be mentioned on order)
APK-PB25A10-002 (0,5 - 1,0 mm <sup>2</sup> )	WWZ.20-100-APK25-10-002	121586-5134
APK-PB25A25-002 (1,5 - 2,5 mm <sup>2</sup> )	WWZ.20-100-APK25-25-002	121586-5135
APK-PB25A40-002 (2,5 - 4,0 mm <sup>2</sup> )	WWZ.20-100-APK25-40-002	121586-5136

**Contact Extraction Tool**



Designation	Order No.
CET-APK25	192900-0176

\* Contact layout is not specified by DIN 72585

**Electrical Data**

Voltage	48 VDC max.
Current	12 A max. for wire size 0,5 mm <sup>2</sup> / 25°C
	19 A max. for wire size 1,5 mm <sup>2</sup> / 25°C
Contact resistance	≤ 5mΩ
Test Voltage	1000 VAC (Ueff)
Insulation resistance	10MΩ

**Mechanical Data**

Sealing acc. to IEC 529 and DIN 40050, Part 9	IP 67 and IP 69K
Operating Temperature Range	-40°C / 125°C
Shock / Vibration	20g acc. to DIN 72585
Durability	50 Mating cycles

**Materials**

Connector housing	PBT
O-ring	HNBR
Contacts	Copper alloy, tinned
Coupling nut	PA

**Standards and Specifications (in accordance with DIN 72585) Environmental**

DIN 40050, Part 9	Sealing
DIN 50016	Humidity
DIN 50021	Resistance against fluids, Salt spray test
DIN 51512	Lubricants such as engine oil, grease, etc.
DIN EN 590	Diesel fuel, gasoline
DIN ISO 4925	Brake fluids, anti-freeze, coolants

**Derating Curve**

APD 6-/7-WAY  
Cable 0,5 mm<sup>2</sup>

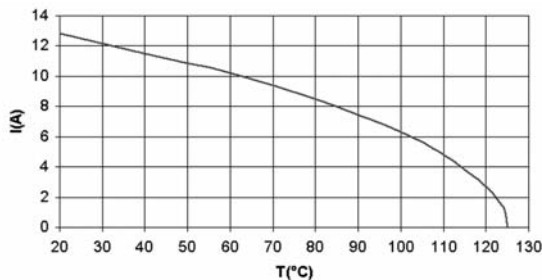

APD 6-/7-WAY  
Cable 1,5 mm<sup>2</sup>

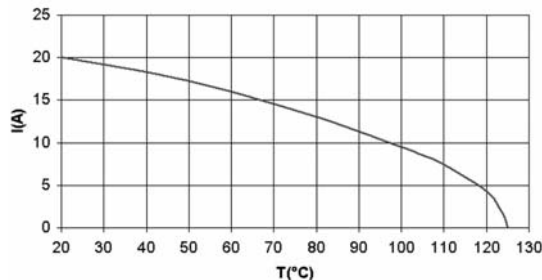

Plug, 7-way

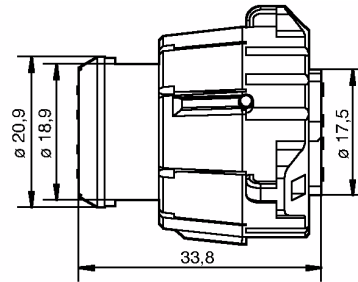
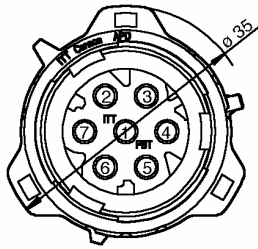

Order No.	Designation	Code	Color
121583-0018	APD-1BS7	1	black (RAL 9005)
120110-0024	APD-1BS6	1	black (RAL 9005) contact cavity 1 closed

Packaging unit 100 pcs.

6-/7-way

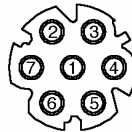

7 way

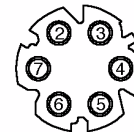

6 way

Socket Crimp-Contacts, Individual wire-seal, Wire filler, see page 13

Flange Receptacle, 7-way (for standard contacts)

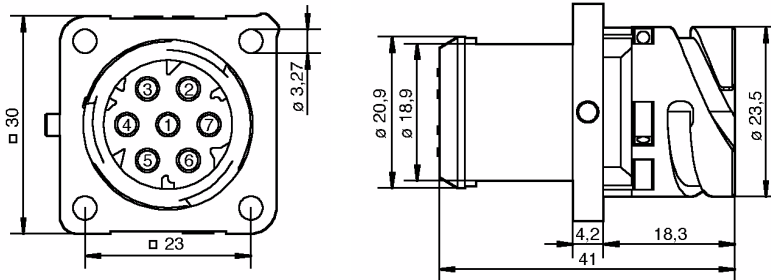

	Order No.	Designation	Code	Color
	121583-0020	APD-1AP7	1	black (RAL 9005)
	121583-0060	APD-1AP6	1	black (RAL 9005) (contact cavity 1 closed)
Optional	120110-0083	APD-1AP6-SPL	1	black (contact cavity 1 closed)

Pin Crimp-Contacts, Individual wire-seal, Wire filler, Flange gasket, see page 13

6-/7-way with crimp press-in contacts

6-way Flange Receptacle  
Order No. APD 120110-0020

7-way Flange Receptacle  
Order No. upon request

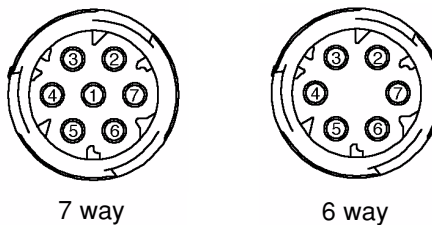

Press-in Crimp Contact

For Flange and Jam Nut Receptacle 6-/7-way

Order No.  
330-8672-021 (tinned) (0,75 - 1,5 mm<sup>2</sup>)  
330-8672-019 (tinned) (0,35 - 0,75 mm<sup>2</sup>)  
with gold flash plate upon request  
Packaging unit: 100 pcs

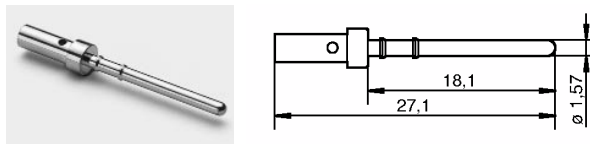

Note - Press-in Crimp Contacts are not removable after insertion

Panel Cut Out

Flange for all Flange Receptacles

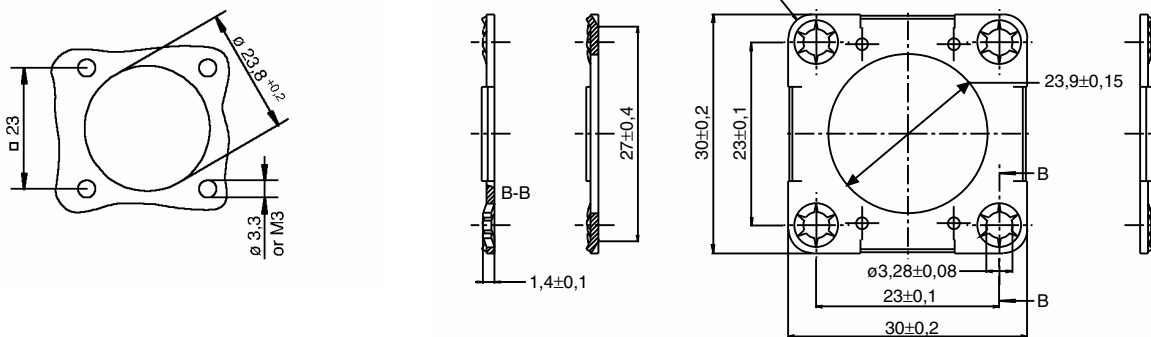

Order Number: 066-8516-005

Jam Nut Receptacle, 7-way (for standard contacts)

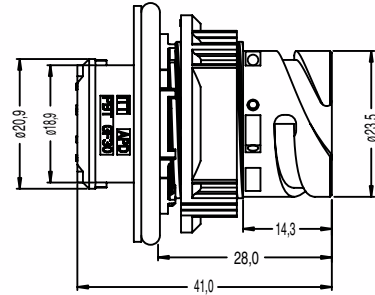
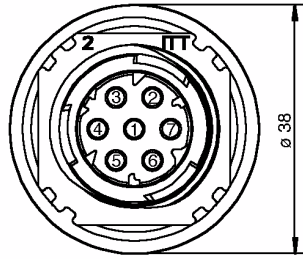

Order No.	Designation	Code	Color
121583-0019	APD-1CP7	1	black (RAL 9005)
121583-0061	APD-1CP6	1	black (RAL 9005)

(contact cavity 1 closed)

Packaging unit 100 pcs.

Crimp-Contacts, Individual wire-seal, Wire filler, see page 13

6-/7-way with crimp press-in contacts

6-way Jam Nut Receptacle  
 Order No. upon request

7-way Jam Nut Receptacle  
 Order No. 121583-0028

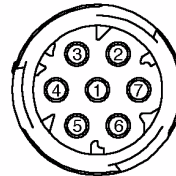

7 way

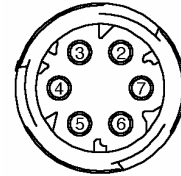

6 way

Press-in Crimp Contact

For Flange and Jam Nut Receptacle 7-way

Order No.  
 330-8672-021 (tinned) (0,75 - 1,5 mm<sup>2</sup>)  
 330-8672-019 (tinned) (0,35 - 0,75 mm<sup>2</sup>)  
 with gold flash plate upon request  
 Packaging unit: 100 pcs

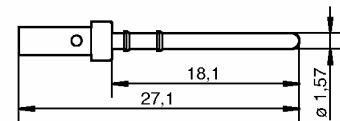

Note - Press-in Crimp Contacts are not removable after insertion

Panel Cut Out

Flange for all Flange Receptacles

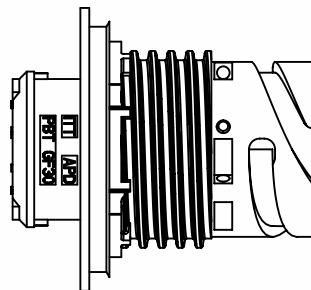
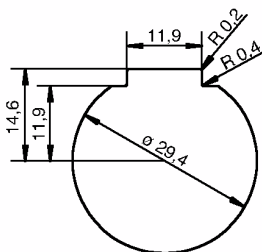

Housing



O-ring



Wall Thickness



Jam Nut

Standard: min. 1,0 / max. 4,0 mm  
 Special: min. 2,0 / max. 5,0 mm

**Socket Crimp-Contacts 1,6 mm Standard Tinned, 3000 contacts per reel**

Order No. 192900-0001 (0,5 - 1,5 mm<sup>2</sup>)

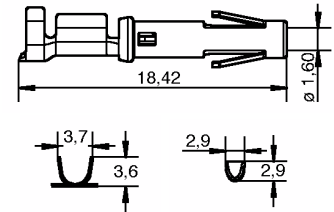

**Pin Crimp-Contacts 1,6 mm Standard Tinned, 3000 contacts per reel**

Order No. 192900-0000 (0,5 - 1,5 mm<sup>2</sup>)

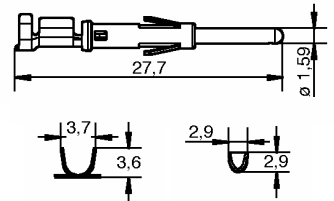

**Individual Wire Seals**

Designation	Order No.
10GR3940 Wire insulation $\varnothing$ 1,4 - 2,0 mm / gray	273-8506-008
10YE3940 Wire insulation $\varnothing$ 1,9 - 2,1 mm / yellow	273-8506-009
10RD3940 Wire insulation $\varnothing$ 1,2 - 1,6 mm / red	273-8506-010

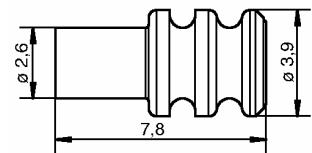

**Wire Filler**

Designation	Order No.
10WH3940 white	273-8506-011

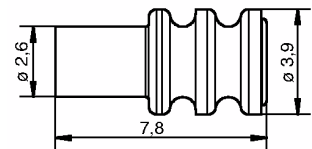

**Flange Gasket for all Flansch Receptacle**

Order No. 075-8503-000 (-55/125° C)
075-8503-004 (-30/200° C)
Packaging unit 100 pcs.

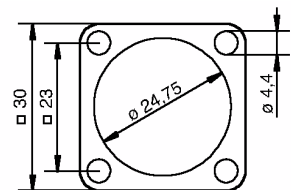

**Alignment Disc**

Order No. 052-8509-002
for pin contact only

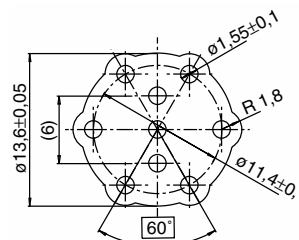

**Jam Nut, special**

Designation	Order No.
for special wall thickness 1,0 - 4,0 mm	217-8516-002

**Crimp Machine for Volume Production**

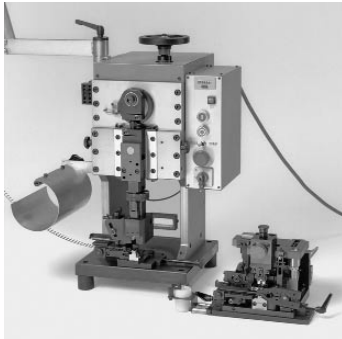

Designation:	Order No.
EPS 2000	121586-5039

**Quick Change Tool for above Crimp Machine: (Mini Applicator)**

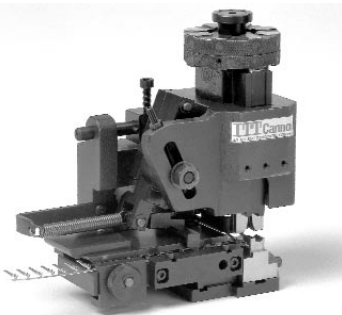

Contact / Socket	Designation	Order No. (to be mentioned on order)
192900-0001 (0,5 - 1,5 mm <sup>2</sup> )	WWZ.20-100-Trident 16-18-002	121586-519
Contact / Socket	Designation	Order No. (to be mentioned on order)
192900-0000 (0,5 - 1,5 mm <sup>2</sup> )	WWZ.20-100-Trident 16-18-002	121586-5190

**Contact Extraction Tool**



Description	Order No.
Trident Extraction Tool	192922-1450
Wire Insulation Stripping length: 4,5 mm	

**Crimp and assembly Tools for press in contacts**



Basic - Hand Crimp Tool	Order No.
M22520-1-01	995-0001-585

Turret (Locator) (for hand crimp tool)		
330-8672-021	CT120090-163	120090-0163
330-8672-019	CT120090-163	120090-0163



Insertion Tool	Order No.
CIT-APD 16-TIP	317-8648-008

Hand Lever - Press	Order No.
CHPZ-240	121586-0081

\* Contact layout not specified by DIN 72585

**Electrical Data**

Voltage	48 VDC max.
Current	245 A max. for wire size 50 mm <sup>2</sup> / 25°C
Contact resistance	≤ 0,4 mΩ
Test Voltage	1000 VAC (Ueff)
Insulation resistance	10MΩ

**Mechanical Data**

Sealing acc. to IEC 529 and DIN 40050, Part 9	IP 67 and IP 69K
Operating Temperature Range	-40°C / 125°C
Shock / Vibration	acc. to DIN 72585
Durability	50 Mating cycles

**Materials**

Connector housing	PBT
O-ring	HNBR
Contacts	Copper alloy, silver plated
Coupling nut	PA

**Standards and Specifications (in accordance with DIN 72585) Environmental**

DIN 40050, Part 9	Sealing
DIN 50016	Humidity
DIN 50021	Resistance against fluids, Salt spray test
DIN 51512	Lubricants such as engine oil, grease, etc.
DIN EN 590	Diesel fuel, gasoline
DIN ISO 4925	Brake fluids, anti-freeze, coolants

**Derating Curve**

APD 1-WAY  
Cable 50 mm<sup>2</sup>

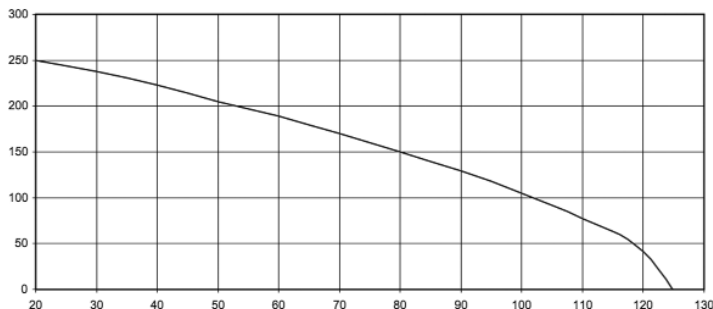

APD - High Power Contacts # 500, wire size 50mm<sup>2</sup> (AWG 0)



High Power Plug, 1-way

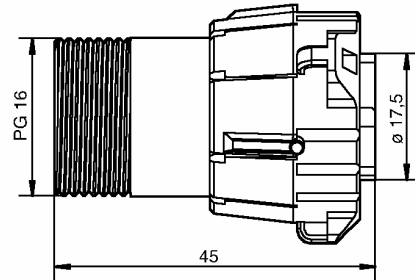
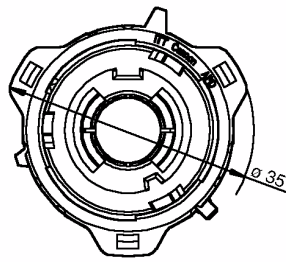

Order No.	Designation	Code	Color
121583-0012	APD-5BSH	5	blue (RAL 5012)
121583-0013	APD-6BSH	6	red (RAL 2002)
121583-0042	APD-7BSH	7	black (RAL 9005)

Packaging unit 100 pcs.

Coding, 1-way layouts

View on Mating Face

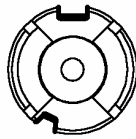

code 5  
blue

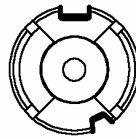

code 6  
red

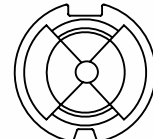

code 7  
black

Note: the connectors offer both mechanical keying and visual coding by different colors

Socket Crimp-Contacts, Cable seal, Hexagonal nut, see pages 19 and 20.

High Power Flange Receptacle, 1-way

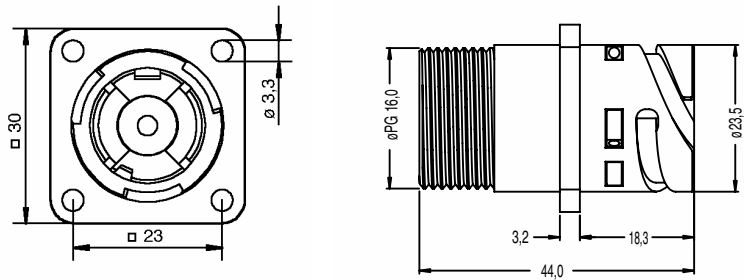

Order No.	Designation	Code	Color
121583-0014	APD-5APH	5	blue (RAL 5012)
121583-0015	APD-6APH	6	red (RAL 2002)
121583-0043	APD-7APH	7	black (RAL 9005)

Packaging unit 100 pcs.

Coding, 1-way layouts

View on Mating Face

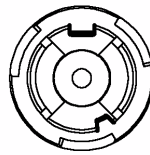

code 5  
blue

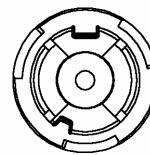

code 6  
red

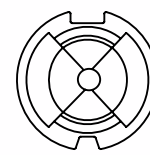

code 7  
black

Note: the connectors offer both mechanical keying and visual coding by different colors

Panel Cut Out

Flange for all Flange Receptacles

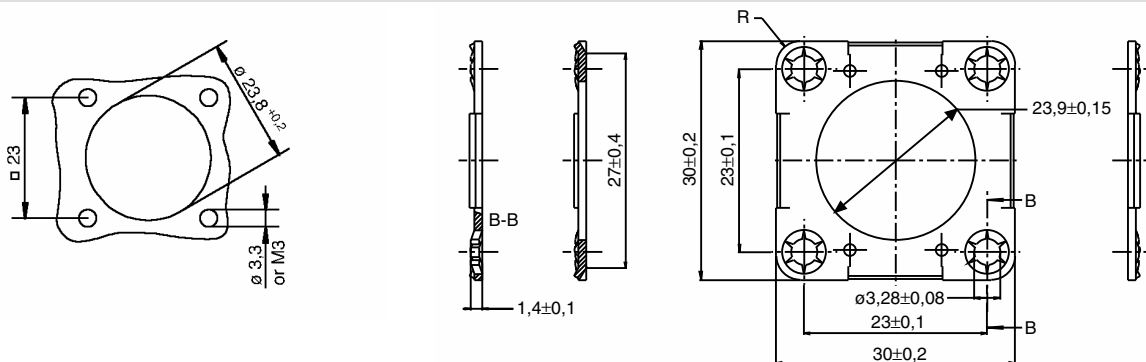

Order Number: 066-8516-005

Machined Pin-Contacts, Contact for ring lock termination, O-ring, Cable seal, Hexagonal nut, Flange gasket, see pages 19 and 20.

High Power Jam Nut Receptacle, 1-way

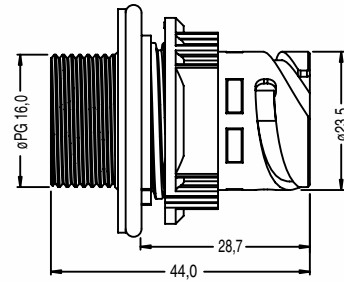
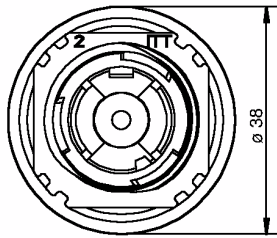

Order No.	Designation	Code	Color
121583-0016	APD-5CPH	5	blue (RAL 5012)
121583-0017	APD-6CPH	6	red (RAL 2002)

Packaging unit 100 pcs.

Coding, 1-way layouts

View on Mating Face

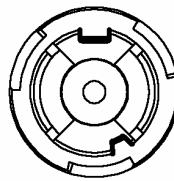

code 5  
blue

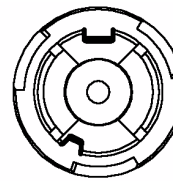

code 6  
red

Note: the connectors offer both mechanical keying and visual coding by different colors

Panel Cut Out

Flange for all Flange Receptacles

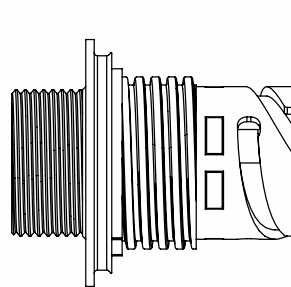
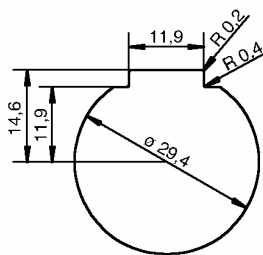

Housing

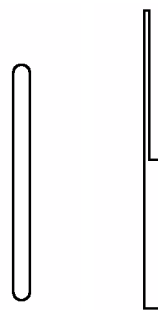

O-ring

Wall  
Thickness

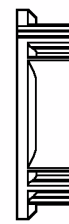

Jam Nut

Standard: min. 1,0 / max. 4,0 mm  
Special: min. 2,0 / max. 5,0 mm

Machined Pin-Contacts, Contact for ring lock termination, O-ring, Cable seal, Hexagonal nut, Flange gasket, see pages 20 and 21.

**Machined Socket Crimp-Contacts Standard, Silver plated**

Order No.	AWG	Contact size	d5+0,15
031-8521-030 (16,00 mm <sup>2</sup> )		0	6,2
031-8521-010 (25,00 mm <sup>2</sup> )	4	0	7,6
031-8521-020 (35,00 mm <sup>2</sup> )	2	0	9,1
031-8561-000 (50,00 mm <sup>2</sup> )		0	10,7
031-8521-000 (53,40 mm <sup>2</sup> )	0	0	11,5

Packaging unit 100 pcs

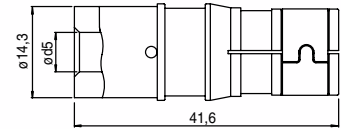

**Machined Pin Crimp Contacts, Standard Silver plated**

Order No.	AWG	contact size	d6+0,15
030-8614-030 (16,00 mm <sup>2</sup> )		0	6,2
030-8614-010 (25,00 mm <sup>2</sup> )	4	0	7,6
030-8614-020 (35,00 mm <sup>2</sup> )	2	0	9,1
030-8592-000 (50,00 mm <sup>2</sup> )		0	10,7
030-8614-000 (53,40 mm <sup>2</sup> )	0	0	11,5

Packaging unit 100 pcs

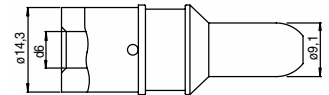

**Contact for ring lock terminals**

**For Flange and Jam Nut Receptacle, High Power 1-way**

Order No.	Thread
031-8531-008	M8 X 13
031-8531-009	M8 X 24

Packaging unit 100 pcs

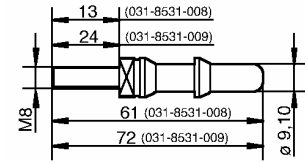

**O-Ring for contact sealing with threaded stud**

**For Pin Contact Sealing High Power 1-way**

Order No.	980-8605-002
-----------	--------------

Packaging unit 100 pcs



**Cable Seal for Cable (in acc. to DIN 670722 FLY/ DIN 72551 FLRY) For all Style, High Power 1-way**

Order No.	Insulation $\phi$	$\phi$ A mm
351-8697-005	5,8 - 7,4	5,4
351-8697-009	8,4 - 10,0	8,0
351-8697-001	10,4 - 12,0	10,0
351-8697-002	12,3 - 13,5	11,9
351-8697-003	14,2 - 15,8	13,8

Packaging unit 100 pcs.

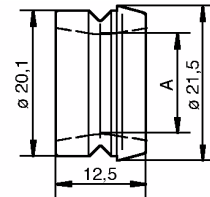

**Hexagonal Nut**

**For all Style, High Power 1-way**

Order No.	217-8516-010
-----------	--------------

Packaging unit 100 pcs

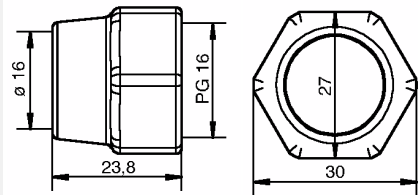
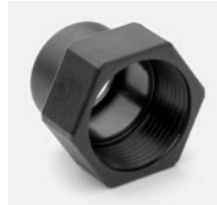

**Flange Gasket**

**For Flange Receptacle, High Power 1-way**

Order No.	075-8503-000 (-55/125° C)
	075-8503-004 (-30/200° C)

Packaging unit 100 pcs.

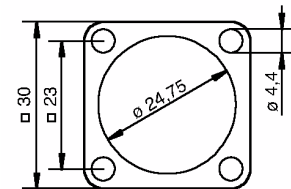

**Jam Nut, special**

Designation	Order No.
for special wall thickness 2,0 - 5,0 mm	217-8516-002

**Tooling for 1-way High Power Connectors**

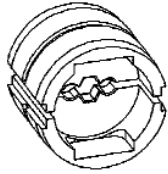

Contact / Socket	Crimp-Dies
031-8521-000 (53,40 mm <sup>2</sup> / AWG 0)	121586-5160
031-8561-000 (50,00 mm <sup>2</sup> )	121586-5160
031-8521-020 (35,00 mm <sup>2</sup> / AWG 2)	121586-5160
031-8521-010 (25,00 mm <sup>2</sup> / AWG 4)	121586-5160
031-8521-030 (16,00 mm <sup>2</sup> )	121586-5160

Contact / Socket	Crimp-Dies
030-8614-000 (53,40 mm <sup>2</sup> / AWG 0)	121586-5160
030-8592-000 (50,00 mm <sup>2</sup> )	121586-5160
030-8614-020 (35,00 mm <sup>2</sup> / AWG 2)	121586-5160
030-8614-010 (25,00 mm <sup>2</sup> / AWG 4)	121586-5160
030-8614-030 (16,00 mm <sup>2</sup> )	121586-5160

**Assembly Tools Jam Nut Receptacle**

Square box spanner for torque moment wrench to fix the jam nut

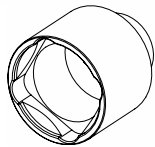

Order No.	CT317-8649-034
-----------	----------------

**Assembly Tools (Hexagonal Nut)**

To fix the hexagonal fixing nut 217-8516-010

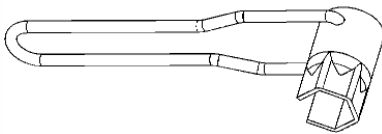

Order No.	980-8672-005
-----------	--------------

**Assembly and Torque Wrench Adapter**

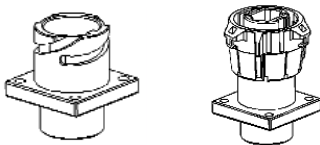

Designation	Order No.
MA-APD-112-P	248-8653-063
MA-APD-112-R	249-8619-010

**Contract Extraction Tool**

Housing can not be reused

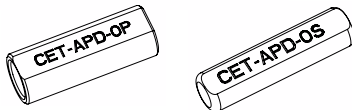

Designation	Order No.
CET-APD#0-Pin	121586-5192
CET-APD#0-Socket	121586-5193

**Crimp Tool**

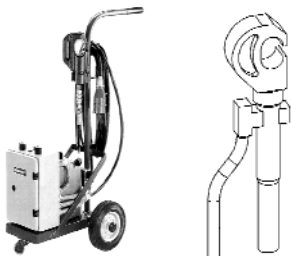

Crimp Tool	Designation	Order No.
Hydraulic, hand operated:	HK120	CT121586-5077
Electro-hydraulic, 230 V AC operated	HK12-EL	CT121586-5075

For detailed assembly instruction please see CAS 25023E

Custom Made Versions



High density APD connector with 37 respectively 51 signal contacts (16 Amp. max.). Combinations of signal and power contacts upon request.



2 to 4-way APD Sensor connector with machined crimp contacts. (Other termination methods are possible). Connector is fixed either by joint flared or over mold.



Y splice Box. (other configurations / arrangements are possible).



Pressure transmitter sensor-connector with PCB terminals. (Other termination methods are possible). Connector is fixed either by flared joint or over-mold.



Sensor Application



Sensor Application

\* Contact layout is not specified by DIN 72585

**Electrical Data**

Voltage	48 VDC max.
Current	74 A max. for wire size 10 mm <sup>2</sup> / 25°C
Contact resistance	≤ 2 mΩ
Test Voltage	1000 VAC (Ueff)
Insulation resistance	10MΩ

**Mechanical Data**

Sealing acc. to IEC 529 and DIN 40050, Part 9	IP 69K
Operating Temperature Range	-40°C / 125°C
Shock / Vibration	acc. to DIN 72585
Durability	50 Mating cycles

**Materials**

Connector housing	PBT
O-ring	HNBR
Contacts	Copper alloy, silver plated
Coupling nut	PA

**Standards and Specifications (in accordance with DIN 72585) Environmental**

DIN 40050, Part 9	Sealing
DIN 50016	Humidity
DIN 50021	Resistance against fluids, Salt spray test
DIN 51512	Lubricants such as engine oil, grease, etc.
DIN EN 590	Diesel fuel, gasoline
DIN ISO 4925	Brake fluids, anti-freeze, coolants

**Derating Curve**

APD 2-WAY  
Cable 10 mm<sup>2</sup>

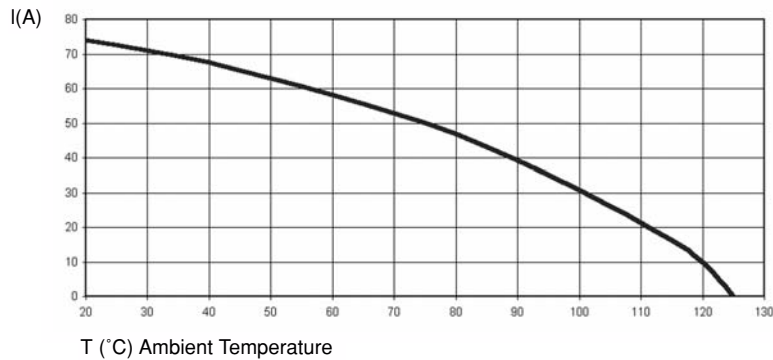



High Power Plug, 2-way

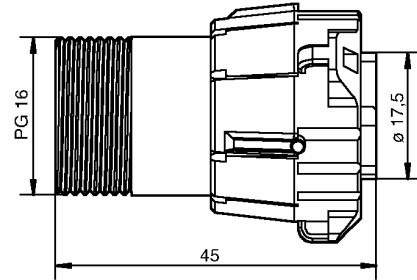
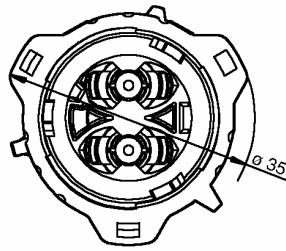

Order No.	Designation	Code	Color
121583-0025	APD-1BSH8-2	5	black (RAL 9005)

Packaging unit 100 pcs.

Socket Crimp-Contacts, Individual Wire Seal, Cable Seal, Hexagonal Nut, see page 28

High Power Flange Receptacle, 2-way

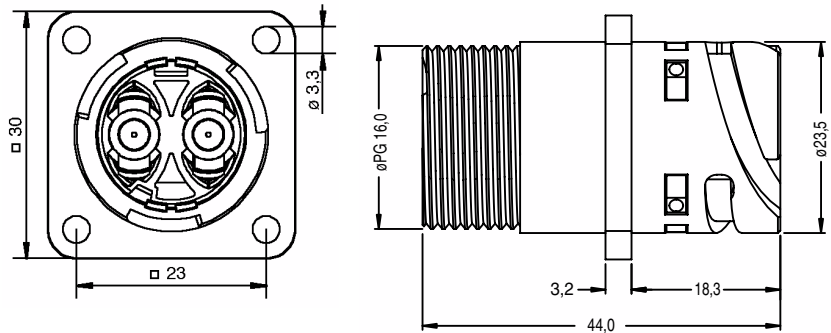

Order No.	Designation	Code	Color
121583-0026	APD-1APH8-2	5	black (RAL 9005)

Packaging unit 100 pcs.

Panel Cut Out

Flange for all Flange Receptacles

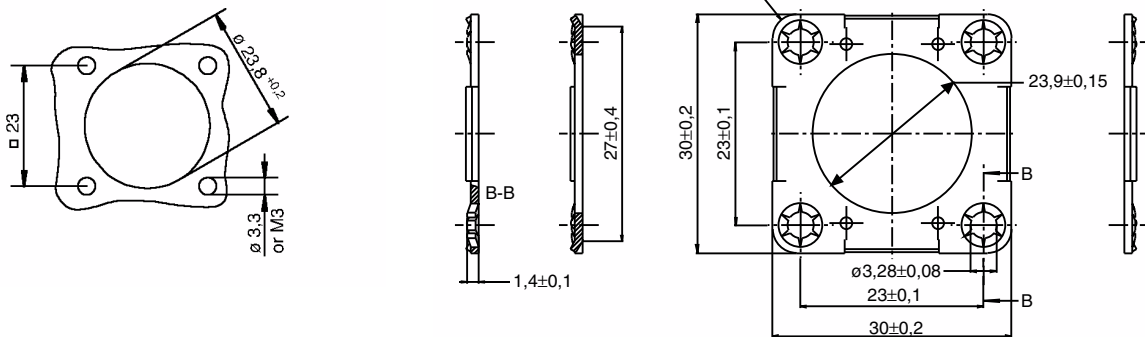

Order Number: 066-8516-005

Machined Pin-Contacts, Individual Wire Seal, Cable Seal, Hexagonal Nut, Flange Gasket, see page 28.

High Power Jam Nut Receptacle, 2-way

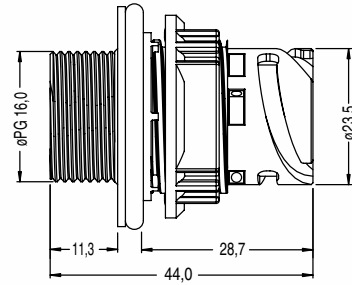
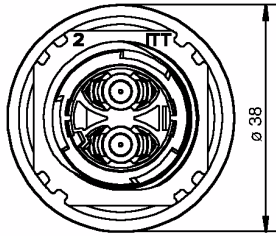

Order No.	Designation	Code	Color
121583-0027	APD-1CPH8-2	5	black (RAL 9005)

Packaging unit 100 pcs.

Panel Cut Out

Flange for all Flange Receptacles

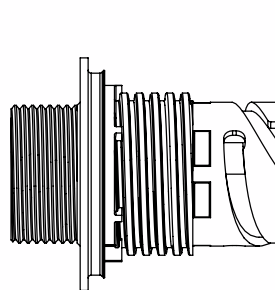
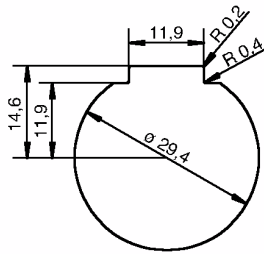

Housing



O-ring



Wall Thickness

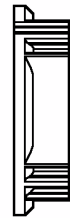

Jam Nut

Standard: min. 1,0 / max. 4,0 mm  
 Special: min. 2,0 / max. 5,0 mm

Machined Pin-Contacts, Individual Wire Seal, Cable Seal, Hexagonal Nut, see page 28.

**Tooling for 2-way High Power Connectors**

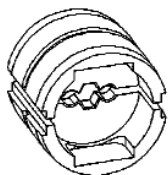

Contact / Socket	Crimp-Dies
031-8646-010 (6,00 mm <sup>2</sup> )	CT120090-165
with individual wire seal	
031-8646-011 (10,00 mm <sup>2</sup> )	CT120090-165
031-8646-002 (AWG 8)	CT120090-165
031-8646-003 (AWG 6)	CT120090-165
031-8646-001 (16,0 mm <sup>2</sup> )	CT120090-171
Contact / Socket	Crimp-Dies
430-8645-000 (6,00 mm <sup>2</sup> )	CT120090-165
with individual wire seal	
430-8645-009 (10,00 mm <sup>2</sup> )	CT120090-165
430-8645-003 (AWG 8)	CT120090-165
430-8645-002 (AWG 6)	CT120090-165
430-8645-007 (16,0 mm <sup>2</sup> )	CT120090-171

**Assembly Tools Jam Nut Receptacle**

Square box spanner for torque wrench to tighten the jam nut

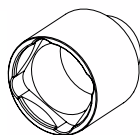

Order No.	CT317-8649-034
-----------	----------------

**Assembly Tools Hexagonal Nut**

To tighten the hexagonal fixing nut 217-8516-010

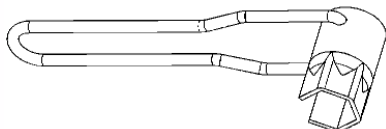

Order No.	980-8672-005
-----------	--------------

**Assembly and Torque Wrench Adapter**

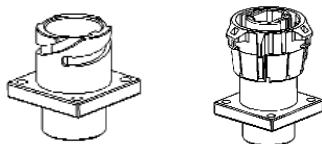

Designation	Order No.
MA-APD-112-P	248-8653-063
MA-APD-112-R	249-8619-010

**Contract Extraction Tool**

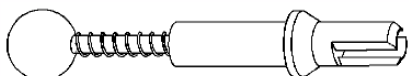

Designation	Order No.
CET- APD-2	121586-5149

**Crimp Tool**

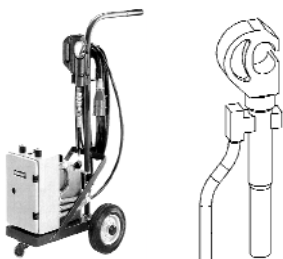

Crimp Tool	Designation	Order No.
Hydraulic, hand operated:	HK120	CT121586-5077
Electro-hydraulic, 230 V AC operated	HK12-EL	CT121586-5075

For detailed assembly instruction please see CAS 25025E

## APD / DIN 72585 Connector

## High Power 2-way, Contacts, Seals, Nut

### Machined Pin Crimp Contacts, Standard Silver Plated

### for Plug, High Power 2-way

Order No.	d6	d8	L1
430-8645-000 (6,00 mm <sup>2</sup> ) *	3,4	6,8	33,4
430-8645-009 (10,00 mm <sup>2</sup> )	4,3	6,8	30,9
430-8645-003 (AWG 8)	3,8	6,8	30,9
430-8645-002 (AWG 6)	5,3	6,8	30,9
430-8645-007 (16,00 mm <sup>2</sup> )	5,5	7,5	30,9

Packaging unit 100 pcs

\* for individual wire seal and grommet

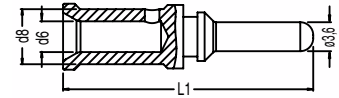

### Machined Socket Crimp Contacts, Standard Silver Plated

Order No.	d5	d7	L2
031-8646-010 (6,00 mm <sup>2</sup> ) *	3,4	6,8	33,4
031-8646-011 (10,00 mm <sup>2</sup> )	4,3	6,8	30,9
031-8646-002 (AWG 8)	3,8	6,8	30,9
031-8646-003 (AWG 6)	5,3	6,8	30,9
031-8646-001 (16,00 mm <sup>2</sup> )	5,5	7,5	30,9

Packaging unit 100 pcs

\* for individual wire seal and grommet

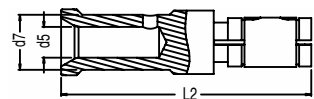

### Individual Wire Seals

### For High Power 2-way 6 mm<sup>2</sup> only

Designation	Order No.:
16GN5824	273-8506-012

wire insulation  $\varnothing$  4,3 - 4,8 mm / green

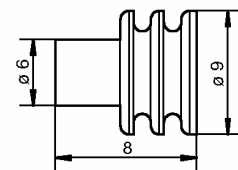

### Grommet/Cable Seal for Cable (acc. to DIN 670722 FLY/DIN 72551 FLRY)

### For High Power 2-way

Order No.	Wire Insulation $\varnothing$	$\varnothing$ A mm
351-8697-000 (6,00 mm <sup>2</sup> )	4,2 - 5,8	3,8
351-8697-007 (10,00 mm <sup>2</sup> )	5,7 - 7,3	5,3
391-8697-010 (16,00 mm <sup>2</sup> )	6,8 - 8,3	6,5
351-8697-013 (6,00 mm <sup>2</sup> )	3,7 - 5,0	3,3

(1 cavity closed)

Packaging unit 100 pcs.

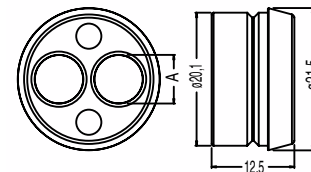

### Hexagonal Nut

### For High Power 2-way

Order No.	217-8516-010
Packaging unit	100 pcs.

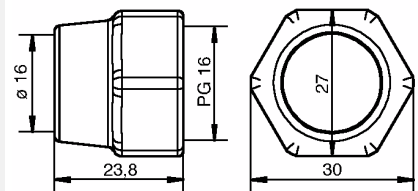
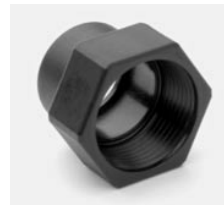

### Flange Gasket

### For Flange Receptacle, High Power 2-way

Order No.	075-8503-000 (-55/125°C)
	075-8503-004 (-30/200°C)
Packaging unit	100 pcs.

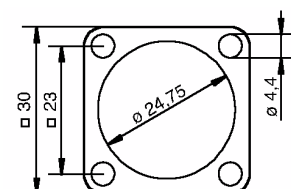
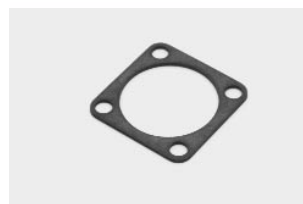

**APD / DIN 72585 Connector**

**Accessories for all styles**

**Sealing Cap for Receptacle**

Applicable for 4-way and 7-way, 1-way HP and 2-way HP

Designation	Order No.
APD-DP	121583-0021

Packaging unit 100 pcs  
with rope upon request  
End link upon request  
X = Total rope length upon request  
Crimp sleeve upon request

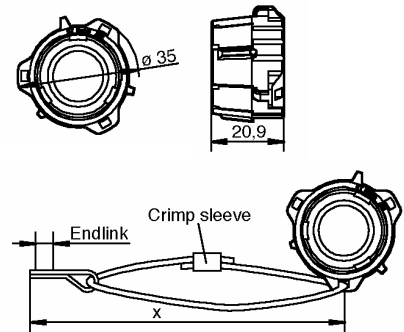

**Straight Endbell for Flex Tube**

Applicable for 4-way and 7-way

Order No.	058-8578-100 ( $\varnothing$ 8,5 mm)
	058-8578-102 ( $\varnothing$ 10,0 mm)

Packaging unit 100 pcs

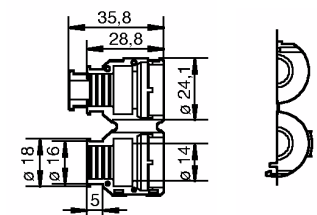

**90° End Bell for Flex Tube**

Applicable for 4-way and 7-way

Order No.	058-8578-101 ( $\varnothing$ 8,5 mm)
	058-8578-103 ( $\varnothing$ 10,0 mm)

Packaging unit 100 pcs

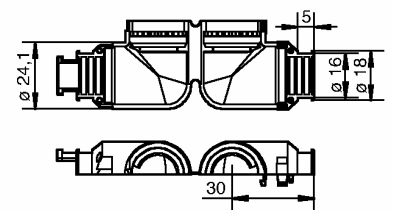

**Flex Tube Adapter  $\varnothing$  21 mm**

Applicable for 1-way and 2-way High Power

Order No.	980-8672-010
-----------	--------------

Packaging unit 100 pcs



**90° End Bell**

Applicable for 1-way High Power up to 25 mm<sup>2</sup> wire

Order No.:	980-8672-004
------------	--------------

Packaging unit 100 pcs

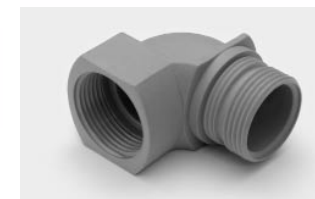

**Jam Nut, special**

Designation	Order No.
for special wall thickness 2,0 - 5,0 mm	217-8516-002

**Dust Cap for Plug**

**Applicable for all APD Plugs**

Order No. 025-8636-005

Packaging unit 100 pcs

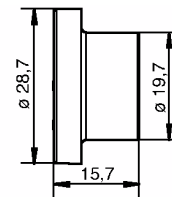

**Dust Cap for Receptacle**

**Applicable for all APD Receptacles**

Order No. 025-0480-000

Packaging unit 100 pcs

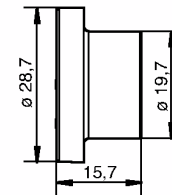

**Cross Reference AWG Size / metric size (mm<sup>2</sup>)**

AWG	mm <sup>2</sup>	AWG	mm <sup>2</sup>	AWG	mm <sup>2</sup>
6/0	170,3	10	5,27	25	0,163
5/0	135,1	11	4,15	26	0,128
4/0	107,2	12	3,31	27	0,102
3/0	85,0	13	2,63	28	0,0804
2/0	67,5	14	2,08	29	0,0646
0	53,4	15	1,65	30	0,0503
1	42,4	16	1,31	31	0,0400
2	33,6	17	1,04	32	0,0320
3	26,7	18	0,823	33	0,0252
4	21,2	19	0,653	34	0,0200
5	16,8	20	0,519	35	0,0161
6	13,3	21	0,412	36	0,0123
7	10,6	22	0,325	37	0,0100
8	8,35	23	0,259	38	0,00795
9	6,62	24	0,205	39	0,00632

Conversion Chart for MM to Inches

mm	Inches	mm	Inches	mm	Inches
1	0.04	18	0.71	35	1.38
2	0.08	19	0.75	36	1.42
3	0.12	20	0.79	37	1.46
4	0.16	21	0.83	38	1.50
5	0.20	22	0.87	39	1.54
6	0.24	23	0.91	40	1.57
7	0.28	24	0.94	41	1.61
8	0.31	25	0.98	42	1.65
9	0.35	26	1.02	43	1.69
10	0.39	27	1.06	44	1.73
11	0.43	28	1.10	45	1.77
12	0.47	29	1.14	46	1.81
13	0.51	30	1.18	47	1.85
14	0.55	31	1.22	48	1.89
15	0.59	32	1.26	49	1.93
16	0.63	33	1.30	50	1.97
17	0.67	34	1.34		

Equation for converting mm to inches:  
 mm divided by 25.4 = inches

Conversion Chart for Centigrade to Fahrenheit

°C	°F	°C	°F	°C	°F
-40	-40.0	-10	+14.0	+10	+50.0
-38	-36.4	-9	+15.8	+11	+51.8
-36	-32.8	-8	+17.6	+12	+53.6
-34	-29.2	-7	+19.4	+13	+55.4
-32	-25.6	-6	+21.2	+14	+57.2
-30	-22.0	-5	+23.0	+15	+59.0
-28	-18.4	-4	+24.8	+16	+60.8
-26	-14.8	-3	+26.6	+17	+62.6
-24	-11.2	-2	+28.4	+18	+64.4
-22	-7.6	-1	+30.2	+19	+66.2
-20	-4.0	0	+32.0	+20	+68.0
-19	-2.2	+1	+33.8	+21	+69.8
-18	+0.4	+2	+35.6	+22	+71.6
-17	+1.4	+3	+37.4	+23	+73.4
-16	+3.2	+4	+39.2	+24	+75.2
-15	+5.0	+5	+41.0	+25	+77.0
-14	+6.8	+6	+42.8	+26	+78.8
-13	+8.6	+7	+44.6	+27	+80.6
-12	+10.4	+8	+46.4	+29	+82.4
-11	+12.2	+9	+48.2	+29	+84.2
				+30	+86.0

Equation for converting Centigrade to Fahrenheit:  
 32 + (C° x 1.8) = Fahrenheit



**THIS NOTE MUST BE READ IN CONJUNCTION WITH THE PRODUCT DATA SHEET/CATALOG. FAILURE TO OBSERVE THE ADVICE IN THIS INFORMATION SHEET AND THE OPERATING CONDITIONS SPECIFIED IN THE PRODUCT DATA SHEET/ CATALOG COULD RESULT IN HAZARDOUS SITUATIONS.**

**1. MATERIAL CONTENT AND PHYSICAL FORM**

Electrical connectors do not usually contain hazardous materials. They contain conducting and non-conducting materials and can be divided into two groups.

- a) Printed circuit types and low cost audio types which employ all plastic insulators and casings.
- b) Rugged, Fire Barrier and High Reliability types with metal casings and either natural rubber, synthetic rubber, plastic or glass insulating materials. Contact materials vary with type of connector and also application and are usually manufactured from either: Copper, copper alloys, nickel, alumel, chromel or steel. In special applications, other alloys may be specified.

**2. FIRE CHARACTERISTICS AND ELECTRIC SHOCK HAZARD**

**There is no fire hazard when the connector is correctly wired and used within the specified parameters. Incorrect wiring or assembly of the connector or careless use of metal tools or conductive fluids, or transit damage to any of the component parts may cause electric shock or burns. Live circuits must not be broken by separating mated connectors as this may cause arcing, ionization and burning.** Heat dissipation is greater at maximum resistance in a circuit. Hot spots may occur when resistance is raised locally by damage, e.g. cracked or deformed contacts, broken strands of wire. Local overheating may also result from the use of the incorrect application tools or from poor quality soldering or slack screw terminals. Overheating may occur if the ratings in the product Data Sheet/Catalog are exceeded and can cause breakdown of insulation and hence electric shock. If heating is allowed to continue it intensifies by further increasing the local resistance through loss of temper of spring contacts, formation of oxide film on contacts and wires and leakage currents through carbonization of insulation and tracking paths. Fire can then result in the presence of combustible materials and this may release noxious fumes. Overheating may not be visually apparent. Burns may result from touching overheated components.

**3. HANDLING**

Care must be taken to avoid damage to any component parts of electrical connectors during installation and use. Although there are normally no sharp edges, care must be taken when handling certain components to avoid injury to fingers. Electrical connectors may be damaged in transit to the customers, and damage may result in creation of hazards. Products should therefore be examined prior to installation/use and rejected if found to be damaged.

**4. DISPOSAL**

Incineration of certain materials may release noxious or even toxic fumes.

**5. APPLICATION**

Connectors with exposed contacts should not be selected for use on the current supply side of an electrical circuit, because an electric shock could result from touching exposed contacts on an unmated connector. Voltages in excess of 30 V ac or 42.5 V dc are potentially hazardous and care should be taken to ensure that such voltages cannot be transmitted in any way to exposed metal parts of the connector body. The connector and wiring should be checked, before making live, to have no damage to metal parts or insulators, no solder blobs, loose strands, conducting lubricants, swarf, or any other undesired conducting particles. Circuit resistance and continuity check should be made to make certain that there are no high resistance joints or spurious conducting paths. Always use the correct application tools as specified in the Data Sheet/Catalog. Do not permit untrained personnel to wire, assemble or tamper with connectors. For operation voltage please see appropriate national regulations.

**IMPORTANT GENERAL INFORMATION**

**(i) Air and creepage paths/Operating voltage.** The admissible operating voltages depend on the individual applications and the valid national and other applicable safety regulations.

For this reason the air and creepage path data are only reference values. Observe reduction of air and creepage paths due to PC board and/or harnessing.

**(ii) Temperature**

All information given are temperature limits. The operation temperature depends on the individual application.

**(iii) Other important information**

Cannon continuously endeavors to improve their products. Therefore, Cannon products may deviate from the description, technical data and shape as shown in this catalog and data sheets.

“Engineered for life” is a registered trademark of ITT Industries, ©2001. All other trademarks or registered trademarks are property of their respective owners. All data subject to change without notice.

**Product Warranty**

ITT Cannon, a Division of ITT Industries, Inc. manufactures the highest quality products available in the marketplace; however these products are intended to be used in accordance with the specifications in this publication. Any use or application that deviates from the stated operating specifications is not recommended and may be unsafe. No information and data contained in this publication shall be construed to create any liability on the part of Cannon. Any new issue of this publication shall automatically invalidate and supersede any and all previous issues. A limited warranty applies to Cannon products. Except for obligations assumed by Cannon under this warranty, Cannon shall not be liable for any loss, damage, cost of repairs, incidental or consequential damages of any kind, whether or not based on express or implied warranty, contract, negligence or strict liability arising in connection with the design, manufacture, sale, use or repair of the products. Product availability, prices and delivery dates are exclusively subject to our respective order confirmation form; the same applies to orders based on development samples delivered. This publication is not to be construed as an offer. It is intended merely as an invitation to make an offer. By this publication, Cannon does not assume responsibility or any liability for any patent infringements or other rights of third parties which may result from its use. Reprinting this publication is generally permitted, indicating the source. However, Cannon's prior consent must be obtained in all cases.

Cannon



## Cannon Connector Products - Worldwide Locations

With manufacturing facilities, sales representatives and distributors located worldwide, please visit our website at [www.ittcannon.com](http://www.ittcannon.com) for a complete listing and to find the office nearest you.

### Customer Support Locations - Connectors

#### Belgium

Keiberg II  
Minervastraat 14  
B-1930 Zaventem, Belgium  
Phone: 32.2.7267594  
Fax: 32.2.7269201

#### China

No. 24, Block 2  
Taohuawu New District  
Zhenjiang  
Phone: 86.511.880.3210  
Fax: 86.511.880.3616

#### Denmark

Kirkebjerg Alle 84  
Brøndby. 2605  
Phone: 45.43.45.52.88  
Fax: 45.43.58.58

#### France

2, Ave Sablons Bouillants  
Meaux, 77109  
Phone: 33.1.60.24.51.51  
Fax: 33.1.64.33.16.82

#### Germany

Postfach 1120,  
Cannonstrasse 1, 71384 Weinstadt  
Phone: 49.7151.699.0  
Fax: 49.7151.699.217

#### Hong Kong

Unit 901 & 912, West Tower  
Sun Tak Center  
168-200 Connaught Road  
Central  
Phone: 852.2732.2720  
Fax: 852.2732.2919

#### Italy

Via Panzeri 10  
Milano, 20123  
Phone: 39.02.58180.1  
Fax: 39.02.8372036

#### Japan

11-3, 5-chome, Hibarigaoka  
Zama-shi, 228-0003  
Phone: 81.462.57.2010  
Fax: 81.462.57.1680

#### Korea

620, Changkang Bldg.  
#22, Dohwa-dong, Mapo-ku  
Netherlands  
Phone: 31.35.691.6855  
Fax: 31.35.691.8796

#### Spain

Edificio Italia 1 a Planta  
Parque Empresarial San Fernando  
San Fernando de Henares, 28831  
Phone: 34.91.656.03.11  
Fax: 34.91.656.15.83

#### Switzerland

Herzogenmühle 18  
Wallisellen, 8304  
Toll free: 41.1.830.3888  
Phone: 41.1.830.3613  
Fax: 41.830.3104

#### UK

Jays Close, Viabes Estate  
Basingstoke, RG22 4BA  
Phone: 44.1256.311200  
Fax: 44.1256.323356

#### USA

666 E. Dyer Road  
Santa Ana, California, 92705-5612  
Toll free: 1.800.854.3028  
Phone: 1.714.557.4700  
Fax: 1.714.628.2142

[www.ittcannon.com](http://www.ittcannon.com)

©2003 ITT Industries, Inc. All rights reserved.

"Engineered for life" is a registered trademark of ITT Industries. ©2003. All other trademarks or registered trademarks are property of their respective owners. All data subject to change without notice.

APD-03-09

## X-ON Electronics

Largest Supplier of Electrical and Electronic Components

*Click to view similar products for [Hand Tools](#) category:*

*Click to view products by [ITT](#) manufacturer:*

Other Similar products are found below :

[568681-1](#) [576786-2](#) [58061-1](#) [58176-1](#) [58177-1](#) [58177-2](#) [58284-1](#) [59085](#) [0031](#) [59737-5](#) [015-0339-000](#) [015-8755-001](#) [600-146-06](#) [M15570-25](#) [62200-5709](#) [6-304052-1](#) [63443-1002](#) [63443-3513](#) [63443-4025](#) [63443-7114](#) [6-354778-5](#) [6-354779-2](#) [63600-2995](#) [63810-0105](#) [M8196914-08](#) [M819698-07](#) [662508-1](#) [662908-1](#) [679994-1](#) [679994-2](#) [68764-0001](#) [69001-0105](#) [69002-5525](#) [690124-7](#) [690191-1](#) [690191-4](#) [690696-1](#) [691409-4](#) [691667-1](#) [692006-2](#) [692655-7](#) [692776-1](#) [692776-4](#) [693077-3](#) [693077-4](#) [693597-1](#) [D20418-137](#) [D20419-189](#) [ESR-17x17](#) [ET-LY10](#)